

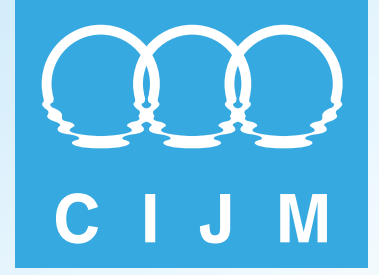

ألعاب البحر الأبيض المتوسط  
MEDITERRANEAN GAMES  
JEUX MÉDITERRANÉENS  
du 25 juin au 06 juillet



# Results Book



## Archery



**TOSYALI  
ALGERIE**

Fer et Acier

سوناطراي



sonarach



microplus  
DATA PROCESSING & TIMING  
[www.microplustiming.com](http://www.microplustiming.com)

**MEDALLISTS BY EVENT**

Event Name	Date	Medal	Name	NOC
Recurve Men	Fri 1 Jul	GOLD	MUSOLESI Federico	ITA Italy
		SILVER	GAZOZ Mete	TUR Turkey
		BRONZE	NESPOLI Mauro	ITA Italy
Recurve Women	Fri 1 Jul	GOLD	FERNANDEZ INFANTE Leyre	ESP Spain
		SILVER	BOARI Lucilla	ITA Italy
		BRONZE	FLORENT Anaëlle	FRA France
Recurve Men Team	Fri 1 Jul	GOLD	BARITEAUD Iban BERNARDI Nicolas FICHET Romain	FRA France
		SILVER	ACHA Pablo ALVARINO GARCIA Miguel CASTRO Daniel	ESP Spain
		BRONZE	AK Samet GAZOZ Mete YILDIRMIS Muhammed	TUR Turkey
Recurve Women Team	Fri 1 Jul	GOLD	ANAGOZ Yasemin BASARAN Ezgi COSKUN Gulnaz	TUR Turkey
		SILVER	ANDREOLI Tatiana BOARI Lucilla REBAGLIATI Chiara	ITA Italy
		BRONZE	FLORENT Anaëlle MAUNIER Lucie VILLARD Laurena	FRA France
Recurve Mixed Team	Fri 1 Jul	GOLD	ANAGOZ Yasemin GAZOZ Mete	TUR Turkey
		SILVER	BOARI Lucilla NESPOLI Mauro	ITA Italy
		BRONZE	CANALES Elia ALVARINO GARCIA Miguel	ESP Spain



## MEDAL STANDINGS

Rank	NOC	Individual				Team				Total				Rank by
		G	S	B	Tot	G	S	B	Tot	G	S	B	Tot	Total
1	TUR Turkey		1		1	2		1	3	2	1	1	4	2
2	ITA Italy	1	1	1	3		2		2	1	3	1	5	1
3	ESP Spain	1			1		1	1	2	1	1	1	3	= 3
4	FRA France			1	1	1		1	2	1		2	3	= 3
<b>Total:</b>		<b>2</b>	<b>2</b>	<b>2</b>	<b>6</b>	<b>3</b>	<b>3</b>	<b>3</b>	<b>9</b>	<b>5</b>	<b>5</b>	<b>5</b>	<b>15</b>	



28 Jun - 1 Jul 2022

Entries

## ENTRIES BY COUNTRY

NOC	Country	Name	W. Rank	Date of Birth	Back No.	Event
ALG	Algeria	BAKRI Imadeddine	620	05 Nov 1999	25A	Recurve Men
		BELLAL Yasmine	437	07 Oct 2003	14A	Recurve Women
		HOCINE Abdelmajid	620	14 Feb 1996	24A	Recurve Men
		RAHLAOUI Ayoub	521	25 Jun 1989	26A	Recurve Men
		MEDANI Ghiles		12 May 1992		Coach
CRO	Croatia	REMAR Alen	131	19 Aug 1999	31B	Recurve Men
		MUJAGIC Emir		06 Sep 1966		Medical Person
		ZORMAN Cvijetoslav		27 Feb 1957		Coach
CYP	Cyprus	CHARALAMBOUS Charalambos	654	18 Nov 1996	27A	Recurve Men
		HADJIEROTOCRITOU Christina	478	06 Nov 1974	8B	Recurve Women
		KOUROUNA Mikaela	401	20 Apr 1994	7B	Recurve Women
		LOIZOU Konstantinos	-	09 Feb 1994	28A	Recurve Men
		PANAGI Constantinos	344	31 Mar 1997	29A	Recurve Men
		PETROU Elena	478	23 Mar 2004	9B	Recurve Women
		KONTEMENIOTIS Antonis		21 Aug 1969		Coach
		THEOPHANOUS Stylianos		20 Jul 1971		Coach
EGY	Egypt	ABDELBAR Aly	701	23 Jun 1996	28B	Recurve Men
		ALY Bahaeldin	461	24 Jun 2002	27B	Recurve Men
		AZZAM Nada	375	10 Dec 2001	11B	Recurve Women
		YASSEN Israa	-	09 Oct 2001	10B	Recurve Women
		ELFEKE Maged		07 Jan 1978		Coach
ESP	Spain	ACHA Pablo	39	04 Aug 1996	19B	Recurve Men
		ALVARINO GARCIA Miguel	2	31 May 1994	18B	Recurve Men
		CANALES Elia	24	25 Jun 2001	2A	Recurve Women
		CASTRO Daniel	24	19 Apr 1997	20B	Recurve Men
		FERNANDEZ INFANTE Leyre	50	06 Sep 2003	3A	Recurve Women
		UNAMUNZAGA ALTUNA Irati	523	29 May 2006	1A	Recurve Women
		CUESTA Elias		15 Mar 1985		Coach
		MONTES Ruben		12 Jun 1981		Team Manager
		SALAS ORTEGA Pablo		31 May 1996		Medical Person
		FRA	France	BARITEAUD Iban	-	25 Dec 2004
BERNARDI Nicolas	129			03 Jan 2003	23B	Recurve Men
FICHET Romain	91			14 Oct 1996	22B	Recurve Men
FLORENT Anaëlle	156			17 Aug 2001	4B	Recurve Women
MAUNIER Lucie	-			29 May 2004	6B	Recurve Women
VILLARD Laurena	83			07 Apr 1994	5B	Recurve Women
AURAIX Jerome				26 May 1973		Coach
BEN BOUDAOU Larbi				05 Mar 1974		Team Manager
BUONOMO Eric				20 Oct 1966		Team Manager
MULLER Gilles, Robert, Bernard				22 Oct 1967		Team Manager
MUSY Frederique				29 Aug 1958		Coach
TOPANDE-MAKOMBO Gilles				02 Feb 1973		Coach
GRE	Greece	GKORILA Anatoli Martha	89	20 Jun 1995	1B	Recurve Women
		KARAGEORGIU Alexandros	279	03 Jun 1986	30B	Recurve Men
		NASOULA Maria	154	13 Sep 2005	2B	Recurve Women
		PSARRA Evangelia	99	17 Jun 1974	3B	Recurve Women
		PAMVOUXOGLU Alexandros		01 Oct 1977		Coach



## ENTRIES BY COUNTRY

NOC	Country	Name	W. Rank	Date of Birth	Back No.	Event
ITA	Italy	ANDREOLI Tatiana	19	01 Jan 1999	7A	Recurve Women
		BOARI Lucilla	10	24 Mar 1997	8A	Recurve Women
		MUSOLESI Federico	28	17 Oct 1998	19A	Recurve Men
		NESPOLI Mauro	6	22 Nov 1987	18A	Recurve Men
		PAOLI Alessandro	33	27 Aug 1999	20A	Recurve Men
		REBAGLIATI Chiara	22	23 Jan 1997	9A	Recurve Women
		BISIANI Matteo		02 Aug 1976		Coach
		BOTTO Giorgio		29 Dec 1967		Coach
		FORTE Elena		08 Jul 1963		Team Manager
SPIGARELLI Sante		31 Oct 1943		Team Manager		
KOS	Kosovo	ASLLANI Hazir	386	24 Apr 1993	17A	Recurve Men
		DVORANI Edi	360	27 Dec 2001	16A	Recurve Men
		GLLAREVA Valmir	474	05 Sep 2005	15A	Recurve Men
		BYLYKBASHI Fehmi		02 Aug 1971		Coach
		MALA Agron		21 Sep 1970		Team Manager
LBA	Libya	ABORGIBA Majdi	-	02 Oct 1966	31A	Recurve Men
		BAAYOU Maran	-	19 Sep 2003	13B	Recurve Women
		KRIMA Entesar		28 May 1970		Coach
LBN	Lebanon	EL RAYES Jacques	496	05 Aug 1986	29B	Recurve Men
POR	Portugal	CARNEIRO Nuno	117	27 Jan 2001	24B	Recurve Men
		GONCALVES Luis	216	28 Aug 1993	26B	Recurve Men
		MATOS Tiago	152	07 Feb 2002	25B	Recurve Men
		GUTIERRES João		22 Dec 1964		Team Manager
		RODRIGUES FÉLIX Paulo Jorge		16 Feb 1980		Medical Person
SLO	Slovenia	CAVIC Urska	73	21 May 1998	10A	Recurve Women
		COREL Nina	129	13 Dec 2005	12A	Recurve Women
		HABJAN MALAVASIC Den	66	15 Jul 1992	17B	Recurve Men
		PODKRAJŠEK Sergej	195	26 Jun 1999	15B	Recurve Men
		RAVNIKAR Ziga	77	25 Dec 1999	16B	Recurve Men
		UMER Ana	62	11 Dec 1990	11A	Recurve Women
		KONCAN Gregor		06 Jul 1977		Coach
SMR	San Marino	FORLANI Jacopo	285	25 Oct 1993	30A	Recurve Men
		OLEI Remo		14 Sep 1951		Coach
SRB	Serbia	BRKIC Anja	-	15 Jan 2002	13A	Recurve Women
		STEFANOVIC Mihajlo	474	19 Oct 2003	32B	Recurve Men
		COLOVIC Mijko		15 Jun 1960		Coach
TUN	Tunisia	ELWALID Rihab	186	14 Jun 1998	12B	Recurve Women
		HAMMED Mohamed	206	23 Sep 1987	32A	Recurve Men
		BEN BRAHIM Saber		11 Jun 1972		Team Manager
		BEN JABALLAH Maaouia		28 Jun 1957		Coach
TUR	Turkey	AK Samet	23	21 Jul 2001	22A	Recurve Men
		ANAGOZ Yasemin	27	14 Oct 1998	6A	Recurve Women
		BASARAN Ezgi	48	20 Jan 2003	4A	Recurve Women
		COSKUN Gulnaz	16	25 Aug 1999	5A	Recurve Women
		GAZOZ Mete	3	08 Jun 1999	21A	Recurve Men
		YILDIRMIS Muhammed	119	07 Nov 2003	23A	Recurve Men
		CORBA Yusuf		21 Apr 1991		Coach
		ERGIN Yusuf Goktug		12 Sep 1984		Coach



## RESULTS SUMMARY

Rank	Name	NOC	
1	MUSOLESI Federico	ITA	Italy
2	GAZOZ Mete	TUR	Turkey
3	NESPOLI Mauro	ITA	Italy
4	BERNARDI Nicolas	FRA	France
5	ALVARINO GARCIA Miguel	ESP	Spain
6	RAVNIKAR Ziga	SLO	Slovenia
7	FICHET Romain	FRA	France
8	CARNEIRO Nuno	POR	Portugal
9	ACHA Pablo	ESP	Spain
	AK Samet	TUR	Turkey
	BAKRI Imadeddine	ALG	Algeria
	BARITEAUD Iban	FRA	France
	CASTRO Daniel	ESP	Spain
	PAOLI Alessandro	ITA	Italy
	REMAR Alen	CRO	Croatia
	STEFANOVIC Mihajlo	SRB	Serbia
17	ABDELBAR Aly	EGY	Egypt
	ALY Bahaeldin	EGY	Egypt
	CHARALAMBOUS Charalambos	CYP	Cyprus
	DVORANI Edi	KOS	Kosovo
	GLLAREVA Valmir	KOS	Kosovo
	GONCALVES Luis	POR	Portugal
	HABJAN MALAVASIC Den	SLO	Slovenia
	HAMMED Mohamed	TUN	Tunisia
	HOCINE Abdelmajid	ALG	Algeria
	KARAGEORGIU Alexandros	GRE	Greece
	LOIZOU Konstantinos	CYP	Cyprus
	MATOS Tiago	POR	Portugal
	PANAGI Constantinos	CYP	Cyprus
	PODKRAJSEK Sergej	SLO	Slovenia
	RAHLAOUI Ayoub	ALG	Algeria
	YILDIRMIS Muhammed	TUR	Turkey
33	ABORGIBA Majdi	LBA	Libya
	ASLLANI Hazir	KOS	Kosovo
	EL RAYES Jacques	LBN	Lebanon
	FORLANI Jacopo	SMR	San Marino



## RESULT BRACKETS

R. Round Rank/Score	Name	NOC Code	Quarterfinals	Semifinals	Finals	
1/ 670	<b>GAZOS Mete</b>	TUR	<b>6</b> (30,27,27,29)	<b>GAZOS M (TUR)</b>		
8/ 649	RAVNIKAR Ziga	SLO	2 (29,28,25,28)	<b>6</b> (29,29,30)	GAZOS M (TUR)	
12/ 639	<b>BERNARDI Nicolas</b>	FRA	<b>7</b> (27,27,28,28)	BERNARDI N (FRA)	4 (23,29,28,23,25)	<b>GOLD</b> MUSOLESI F (ITA)
13/ 633	CARNEIRO Nuno	POR	1 (24,27,26,27)	0 (24,27,28)		
3/ 661	<b>MUSOLESI Federico</b>	ITA	<b>6</b> (29,29,28,29,28)	<b>MUSOLESI F (ITA)</b>		<b>SILVER</b> GAZOS M (TUR)
6/ 653	ALVARINO GARCIA Miguel	ESP	4 (30,28,28,25,28)	<b>6</b> (28,28,29,28)	<b>MUSOLESI F (ITA)</b>	
7/ 649	FICHET Romain	FRA	1 (27,28,28,28)	NESPOLI M (ITA)	<b>6</b> (25,26,27,27,26)	<b>BRONZE</b> NESPOLI M (ITA)
2/ 667	<b>NESPOLI Mauro</b>	ITA	<b>7</b> (30,29,28,30)	2 (26,27,29,28)		
					BERNARDI N (FRA)	
					3 (24,21,27,24,24)	
					<b>NESPOLI M (ITA)</b>	
					7 (24,26,27,24,25)	

### Final Rank

1	MUSOLESI Federico	ITA	
2	GAZOS Mete	TUR	
3	NESPOLI Mauro	ITA	
4	BERNARDI Nicolas	FRA	
5	ALVARINO GARCIA Miguel	ESP	4 (139)
6	RAVNIKAR Ziga	SLO	2 (110)
7	FICHET Romain	FRA	1 (111)
8	CARNEIRO Nuno	POR	1 (104)



## RESULT BRACKETS

R. Round Rank/Score	Name	NOC Code	1/24 Elimin. Round	1/16 Elimin. Round	1/8 Elimin. Round	Quarterfinals	
1/ 670	<b>GAZOU Mete</b> <i>pre-seeded in 1/16th</i>	TUR		<b>GAZOU M (TUR)</b> 6 (30,28,27)	<b>GAZOU M (TUR)</b> 6 (27,27,30,29)	<b>GAZOU M (TUR)</b> 6 (30,27,27,29)	
33/ 532	<b>LOIZOU Konstantinos</b>	CYP	6 (25,24,19,26)	LOIZOU K (CYP)	STEFANOVIC M (SRB) 2 (28,25,29,27)		
32/ 566	FORLANI Jacopo	SMR	2 (23,18,24,20)	0 (18,21,26)			
17/ 628	<b>YILDIRMIS Muhammed</b> -Bye-	TUR		YILDIRMIS M (TUR) 2 (25,24,28,21)	STEFANOVIC M (SRB) 2 (28,25,29,27)		
	-Bye-			<b>STEFANOVIC M (SRB)</b>			
16/ 631	<b>STEFANOVIC Mihajlo</b>	SRB		<b>6 (26,28,27,25)</b>			
9/ 643	<b>ACHA Pablo</b> -Bye-	ESP		<b>ACHA P (ESP)</b> 6 (24,29,28)	ACHA P (ESP) 3 (29,27,27,26,26)		<b>RAVNIKAR Z (SLO)</b> 2 (29,28,25,28)
	-Bye-			KARAGEORGIU A (GRE) 0 (22,24,24)			
24/ 611	<b>KARAGEORGIU Alexandros</b>	GRE					
25/ 606	<b>MATOS Tiago</b> -Bye-	POR		MATOS T (POR) 1 (27,25,24,26)	<b>RAVNIKAR Z (SLO)</b> 7 (28,27,28,28,30)		
	<i>pre-seeded in 1/16th</i>			<b>RAVNIKAR Z (SLO)</b>			
8/ 649	<b>RAVNIKAR Ziga</b>	SLO		7 (27,27,28,27)			
5/ 654	<b>AK Samet</b> <i>pre-seeded in 1/16th</i>	TUR		<b>AK S (TUR)</b> 6 (27,28,27)	AK S (TUR) 4 (24,29,27,29,28)	<b>BERNARDI N (FRA)</b> 7 (27,27,28,28)	
	-Bye-			GONCALVES L (POR) 0 (19,23,23)			
28/ 596	<b>GONCALVES Luis</b>	POR					
21/ 617	<b>PANAGI Constantinos</b> -Bye-	CYP		PANAGI C (CYP) 0 (25,25,27)	<b>BERNARDI N (FRA)</b> 6 (29,29,28,27,28)		
	-Bye-			<b>BERNARDI N (FRA)</b>			
12/ 639	<b>BERNARDI Nicolas</b>	FRA		6 (29,29,28)			
13/ 633	<b>CARNEIRO Nuno</b> -Bye-	POR		<b>CARNEIRO N (POR)</b> 6 (24,27,28)	<b>CARNEIRO N (POR)</b> 6 (24,24,27,26,29)	<b>CARNEIRO N (POR)</b> 1 (24,27,26,27)	
	-Bye-			CHARALAMBOUS C (CYP) 0 (23,24,25)			
20/ 617	<b>CHARALAMBOUS Charalambos</b>	CYP					
29/ 596	<b>BAKRI Imadeddine</b>	ALG	6 (28,21,22)	<b>BAKRI I (ALG)</b>	BAKRI I (ALG) 4 (28,27,24,24,26)		
36/ 499	ABORGIBA Majdi	LBA	0 (10,15,21)				
	<i>pre-seeded in 1/16th</i>			HABJAN MALAVASIC D (SLO)			
4/ 657	<b>HABJAN MALAVASIC Den</b>	SLO		DNS			





## RESULT BRACKETS

R. Round Rank/Score	Name	NOC Code	1/24 Elimin. Round	1/16 Elimin. Round	1/8 Elimin. Round	Quarterfinals
3/ 661	<b>MUSOLESI Federico</b> <i>pre-seeded in 1/16th</i>	ITA		<b>MUSOLESI F (ITA)</b> 7 (28,26,28,28)	<b>MUSOLESI F (ITA)</b> 6 (27,30,29)	<b>MUSOLESI F (ITA)</b> 6 (29,29,28,29,28)
35/ 501	EL RAYES Jacques	LBN	0 (23,15,22)	ALY B (EGY)	<b>MUSOLESI F (ITA)</b> 6 (27,30,29)	
30/ 583	<b>ALY Bahaeldin</b>	EGY	6 (26,20,29)	1 (28,23,26,19)		
19/ 618	<b>ABDELBAR Aly</b> -Bye-	EGY		ABDELBAR A (EGY) 3 (26,27,26,27,20)	REMAR A (CRO) 0 (26,25,28)	
	-Bye-			<b>REMAR A (CRO)</b> 7 (26,26,28,30,27)		
14/ 633	<b>REMAR Alen</b>	CRO				
11/ 641	<b>PAOLI Alessandro</b> -Bye-	ITA		<b>PAOLI A (ITA)</b> 6 (28,29,27,26,25)	PAOLI A (ITA) 1 (26,28,27,28)	
	-Bye-			GLLAREVA V (KOS) 4 (25,25,30,27,24)	ALVARINO GARCIA M (ESP) 4 (30,28,28,25,28)	
22/ 614	<b>GLLAREVA Valmir</b>	KOS				
27/ 598	<b>HOCINE Abdelmajid</b> -Bye-	ALG		HOCINE A (ALG) 0 (25,25,26)		
	<i>pre-seeded in 1/16th</i>			<b>ALVARINO GARCIA M (ESP)</b> 6 (27,28,29)		
6/ 653	<b>ALVARINO GARCIA Miguel</b>	ESP				
7/ 649	<b>FICHET Romain</b> <i>pre-seeded in 1/16th</i>	FRA		<b>FICHET R (FRA)</b> 6 (27,27,29)	<b>FICHET R (FRA)</b> 6 (28,25,28,28,27)	FICHET R (FRA) 1 (27,28,28,28)
	-Bye-			PODKRAJŠEK S (SLO) 0 (25,24,28)		
26/ 601	<b>PODKRAJŠEK Sergej</b>	SLO				
23/ 614	<b>HAMMED Mohamed</b> -Bye-	TUN		HAMMED M (TUN) 0 (23,28,27)	CASTRO D (ESP) 4 (29,30,27,27,26)	
	-Bye-			<b>CASTRO D (ESP)</b> 6 (28,30,28)		
10/ 642	<b>CASTRO Daniel</b>	ESP				
15/ 632	<b>BARITEAUD Iban</b> -Bye-	FRA		<b>BARITEAUD I (FRA)</b> 6 (27,27,27,26,28)	BARITEAUD I (FRA) 3 (29,27,29,28,24)	<b>NESPOLI M (ITA)</b> 7 (30,29,28,30)
	-Bye-			DVORANI E (KOS) 4 (26,26,28,27,24)		
18/ 622	<b>DVORANI Edi</b>	KOS				
31/ 580	<b>RAHLAOUI Ayoub</b>	ALG	6 (21,23,24,25)	RAHLAOUI A (ALG) 0 (29,23,22)	<b>NESPOLI M (ITA)</b> 7 (27,28,29,29,29)	
34/ 515	ASLLANI Hazir	KOS	2 (26,18,20,23)			
	<i>pre-seeded in 1/16th</i>			<b>NESPOLI M (ITA)</b> 6 (30,29,27)		
2/ 667	<b>NESPOLI Mauro</b>	ITA				



RESULTS

OFFICIAL After 72 Arrows

World Record 70 metres Round: 702 ELLISON Brady USA Lima (PER) 2019-08-07

Rank	Back No.	Name	NOC	70m-1	70m-2	10+X's	X's	Score
1	21A	GAZOZ Mete	TUR	335 / 1	335 / 1	30	9	670
2	18A	NESPOLI Mauro	ITA	334 / 2	333 / 2	28	10	667
3	19A	MUSOLESI Federico	ITA	334 / 3	327 / 4	29	5	661
4	17B	HABJAN MALAVASIC Den	SLO	326 / 9	331 / 3	27	7	657
5	22A	AK Samet	TUR	329 / 5	325 / 5	27	7	654
6	18B	ALVARINO GARCIA Miguel	ESP	330 / 4	323 / 6	24	4	653
7	22B	FICHET Romain	FRA	327 / 7	322 / 8	21	4	649
8	16B	RAVNIKAR Ziga	SLO	327 / 8	322 / 8	20	3	649
9	19B	ACHA Pablo	ESP	326 / 10	317 / 11	20	11	643
10	20B	CASTRO Daniel	ESP	321 / 12	321 / 10	19	5	642
11	20A	PAOLI Alessandro	ITA	318 / 15	323 / 7	18	6	641
12	23B	BERNARDI Nicolas	FRA	328 / 6	311 / 19	18	6	639
13	24B	CARNEIRO Nuno	POR	323 / 11	310 / 20	16	2	633
14	31B	REMAR Alen	CRO	316 / 17	317 / 12	13	3	633
15	21B	BARITEAUD Iban	FRA	320 / 13	312 / 14	21	6	632
16	32B	STEFANOVIC Mihajlo	SRB	315 / 18	316 / 13	17	10	631
17	23A	YILDIRMIS Muhammed	TUR	317 / 16	311 / 18	21	10	628
18	16A	DVORANI Edi	KOS	310 / 20	312 / 15	15	1	622
19	28B	ABDELBAR Aly	EGY	319 / 14	299 / 26	18	2	618
20	27A	CHARALAMBOUS Charalambos	CYP	306 / 24	311 / 17	17	5	617
21	29A	PANAGI Constantinos	CYP	309 / 21	308 / 21	16	5	617
22	15A	GLLAREVA Valmir	KOS	313 / 19	301 / 25	15	4	614
23	32A	HAMMED Mohamed	TUN	302 / 27	312 / 16	10	3	614
24	30B	KARAGEORGIU Alexandros	GRE	308 / 22	303 / 23	15	4	611
25	25B	MATOS Tiago	POR	303 / 26	303 / 22	17	6	606
26	15B	PODKRAJŠEK Sergej	SLO	304 / 25	297 / 28	10	3	601
27	24A	HOCINE Abdelmajid	ALG	307 / 23	291 / 29	14	4	598
28	26B	GONCALVES Luis	POR	295 / 31	301 / 24	15	6	596
29	25A	BAKRI Imadeddine	ALG	298 / 28	298 / 27	9	4	596
30	27B	ALY Bahaeldin	EGY	295 / 30	288 / 30	13	5	583
31	26A	RAHLAOUI Ayoub	ALG	298 / 29	282 / 32	7	1	580
32	30A	FORLANI Jacopo	SMR	282 / 32	284 / 31	6	3	566
33	28A	LOIZOU Konstantinos	CYP	263 / 33	269 / 33	8	1	532
34	17A	ASLLANI Hazir	KOS	261 / 34	254 / 36	13	3	515
35	29B	EL RAYES Jacques	LBN	245 / 35	256 / 34	6	2	501
36	31A	ABORGIBA Majdi	LBA	243 / 36	256 / 35	2	1	499



**Eighth of Final Match**

Thu 30 Jun 2022 Starting Time: 09:55

Match Number 85

Target: 21A  
Athlete: **GAZUZ Mete (TUR - Turkey)**  
Bib: 13418

Target: 21B  
Athlete: **STEFANOVIC Mihajlo (SRB - Serbia)**  
Bib: 41943

**Winner**

	Arrows			Tot.	Set Points
1	10	9	8	27	0
2	9	9	9	27	2
3	10	10	10	30	2
4	10	10	9	29	2
5					
					<b>6</b>

	Arrows			Tot.	Set Points
1	X	10	8	28	2
2	9	8	8	25	0
3	10	10	9	29	0
4	10	9	8	27	0
5					
					<b>2</b>



**Eighth of Final Match**

Thu 30 Jun 2022 Starting Time: 09:55

Match Number 86

Target: 22A  
Athlete: **ACHA Pablo (ESP - Spain)**  
Bib: 16213

Target: 22B  
Athlete: **RAVNIKAR Ziga (SLO - Slovenia)**  
Bib: 15129

	Arrows			Tot.	Set Points
1	10	10	9	29	2
2	10	9	8	27	1
3	9	9	9	27	0
4	9	9	8	26	0
5	10	8	8	26	0
					<b>3</b>

Winner					
Set Points		Arrows			Tot.
0	1	X	10	8	28
1	2	X	9	8	27
2	3	10	9	9	28
2	4	10	9	9	28
2	5	X	X	10	30
					<b>7</b>



**Eighth of Final Match**

Thu 30 Jun 2022 Starting Time: 09:55

Match Number 87

Target: 23A  
Athlete: **AK Samet (TUR - Turkey)**  
Bib: 23135

Target: 23B  
Athlete: **BERNARDI Nicolas (FRA - France)**  
Bib: 30447

	Arrows			Tot.	Set Points
1	X	8	6	24	0
2	10	10	9	29	1
3	9	9	9	27	0
4	X	X	9	29	2
5	X	9	9	28	1
					<b>4</b>

Winner					
Set Points		Arrows			Tot.
2	1	X	10	9	29
1	2	X	10	9	29
2	0	10	9	9	28
0	1	10	9	8	27
1	5	X	9	9	28
					<b>6</b>



### Eighth of Final Match

Thu 30 Jun 2022 Starting Time: 09:55

Match Number 88

Target: 24A  
Athlete: **CARNEIRO Nuno (POR - Portugal)**  
Bib: 26737

Target: 24B  
Athlete: **BAKRI Imadeddine (ALG - Algeria)**  
Bib: 19825

#### Winner

	Arrows			Tot.	Set Points
1	10	7	7	24	0
2	X	9	5	24	0
3	9	9	9	27	2
4	9	9	8	26	2
5	10	10	9	29	2
					<b>6</b>

Set Points	Arrows				Tot.
2	1	X	10	8	28
2	2	10	9	8	27
0	3	9	9	6	24
0	4	9	8	7	24
0	5	9	9	8	26
					<b>4</b>



**Eighth of Final Match**

Thu 30 Jun 2022 Starting Time: 09:55

Match Number 89

Target: 25A  
Athlete: **MUSOLESI Federico (ITA - Italy)**  
Bib: 17656

Target: 25B  
Athlete: **REMAR Alen (CRO - Croatia)**  
Bib: 15290

Winner

	Arrows			Tot.	Set Points
1	9	9	9	27	2
2	X	10	10	30	2
3	10	10	9	29	2
4					
5					
					<b>6</b>

Set Points	Arrows			Tot.	
0	1	9	9	8	26
0	2	9	8	8	25
0	3	10	9	9	28
	4				
	5				
<b>0</b>					



**Eighth of Final Match**

Thu 30 Jun 2022 Starting Time: 09:55

Match Number 90

Target: 26A  
Athlete: **PAOLI Alessandro (ITA - Italy)**  
Bib: 27225

Target: 26B  
Athlete: **ALVARINO GARCIA Miguel (ESP - Spain)**  
Bib: 13410

	Arrows			Tot.	Set Points
1	9	9	8	26	0
2	X	X	8	28	1
3	10	9	8	27	0
4	10	9	9	28	0
5					
					<b>1</b>

Winner					
Set Points	Arrows			Tot.	
2	1	10	10	9	29
1	2	10	9	9	28
2	3	10	10	9	29
2	4	10	10	9	29
	5				
					<b>7</b>





### Eighth of Final Match

Thu 30 Jun 2022 Starting Time: 09:55

Match Number 91

Target: 27A  
Athlete: **FICHET Romain (FRA - France)**  
Bib: 12391

Target: 27B  
Athlete: **CASTRO Daniel (ESP - Spain)**  
Bib: 15489

#### Winner

	Arrows			Tot.	Set Points
1	10	9	9	28	0
2	9	9	7	25	0
3	X	9	9	28	2
4	10	9	9	28	2
5	X	9	8	27	2
					<b>6</b>

Set Points		Arrows			Tot.
2	1	X	10	9	29
2	2	X	10	10	30
0	3	9	9	9	27
0	4	9	9	9	27
0	5	9	9	8	26
					<b>4</b>



### Eighth of Final Match

Thu 30 Jun 2022 Starting Time: 09:55

Match Number 92

Target: 28A  
Athlete: **BARITEAUD Iban (FRA - France)**  
Bib: 41671

Target: 28B  
Athlete: **NESPOLI Mauro (ITA - Italy)**  
Bib: 5796

	Arrows			Tot.	Set Points
1	10	10	9	29	2
2	10	9	8	27	0
3	10	10	9	29	1
4	X	10	8	28	0
5	8	8	8	24	0
					<b>3</b>

Winner					
Set Points	Arrows			Tot.	
0	1	10	9	8	27
2	2	10	9	9	28
1	3	X	10	9	29
2	4	X	X	9	29
2	5	10	10	9	29
					<b>7</b>



### Gold Medal Match

Fri 1 Jul 2022 Starting Time: 15:25

Match Number 136

Target: 1  
Athlete: **GAZUZ Mete (TUR - Turkey)**  
Bib: 13418

Target: 2  
Athlete: **MUSOLESI Federico (ITA - Italy)**  
Bib: 17656

	Arrows			Tot.
1	7	8	8	23
2	10	9	10	29
3	9	10	9	28
4	7	8	8	23
5	6	9	10	25

Set Points
0
2
2
0
0

**4**

### Winner

	Arrows			Tot.
1	7	9	9	25
2	9	9	8	26
3	8	9	10	27
4	8	9	10	27
5	8	9	9	26

**6**

Line Judge: LAMANDÉ Khaled Sofiane

Target Judge: KOURA Ahmed



**Bronze Medal Match**

Fri 1 Jul 2022 Starting Time: 15:10

Match Number 135

Target: 1  
Athlete: **BERNARDI Nicolas (FRA - France)**  
Bib: 30447

Target: 2  
Athlete: **NESPOLI Mauro (ITA - Italy)**  
Bib: 5796

	Arrows			Tot.
1	9	7	8	24
2	6	8	7	21
3	8	9	10	27
4	9	7	8	24
5	5	9	10	24

Set Points
1
0
1
1
0

**3**

**Winner**

Set Points
1
2
1
1
2

**7**

	Arrows			Tot.
1	7	9	8	24
2	7	10	9	26
3	10	8	9	27
4	8	9	7	24
5	8	9	8	25

Line Judge: ZURBANO Irati

Target Judge: KOURA Ahmed



**Quarterfinal Match**

Thu 30 Jun 2022 Starting Time: 10:35

Match Number 101

Target: 21  
Athlete: **GAZUZ Mete (TUR - Turkey)**  
Bib: 13418

Target: 22  
Athlete: **RAVNIKAR Ziga (SLO - Slovenia)**  
Bib: 15129

**Winner**

	Arrows			Tot.	Set Points
1	10	10	10	30	2
2	9	9	9	27	0
3	9	9	9	27	2
4	10	10	9	29	2
5					
					<b>6</b>

Set Points	Arrows			Tot.	
0	1	10	10	9	29
2	2	10	9	9	28
0	3	9	8	8	25
0	4	10	9	9	28
	5				
					<b>2</b>



**Quarterfinal Match**

Thu 30 Jun 2022 Starting Time: 10:35

Match Number 102

Target: 23  
Athlete: **BERNARDI Nicolas (FRA - France)**  
Bib: 30447

Target: 24  
Athlete: **CARNEIRO Nuno (POR - Portugal)**  
Bib: 26737

**Winner**

	Arrows			Tot.	Set Points
1	9	9	9	27	2
2	10	9	8	27	1
3	10	9	9	28	2
4	10	9	9	28	2
5					
					<b>7</b>

Set Points	Arrows			Tot.	
0	1	8	8	8	24
1	2	9	9	9	27
0	3	9	9	8	26
0	4	X	9	8	27
	5				
					<b>1</b>



**Quarterfinal Match**

Thu 30 Jun 2022 Starting Time: 10:35

Match Number 103

Target: 25  
Athlete: **MUSOLESI Federico (ITA - Italy)**  
Bib: 17656

Target: 26  
Athlete: **ALVARINO GARCIA Miguel (ESP - Spain)**  
Bib: 13410

**Winner**

	Arrows			Tot.	Set Points
1	10	10	9	29	0
2	X	10	9	29	2
3	10	9	9	28	1
4	X	10	9	29	2
5	10	10	8	28	1
					<b>6</b>

	Arrows			Tot.	Set Points
1	10	10	10	30	2
2	10	9	9	28	0
3	X	9	9	28	1
4	9	8	8	25	0
5	X	9	9	28	1
					<b>4</b>



### Quarterfinal Match

Thu 30 Jun 2022 Starting Time: 10:35

Match Number 104

Target: 27  
Athlete: **FICHET Romain (FRA - France)**  
Bib: 12391

Target: 28  
Athlete: **NESPOLI Mauro (ITA - Italy)**  
Bib: 5796

	Arrows			Tot.	Set Points
1	X	9	8	27	0
2	X	10	8	28	0
3	X	9	9	28	1
4	10	9	9	28	0
5					
					<b>1</b>

Winner					
Set Points	Arrows			Tot.	
2	1	10	10	10	30
2	2	10	10	9	29
1	3	X	9	9	28
2	4	X	X	10	30
	5				
					<b>7</b>





**1/16 of Final Match**

Thu 30 Jun 2022 Starting Time: 09:15

Match Number 53

Target: 17A  
Athlete: **GAZOU Mete (TUR - Turkey)**  
Bib: 13418

Target: 17B  
Athlete: **LOIZOU Konstantinos (CYP - Cyprus)**  
Bib: 9382

**Winner**

	Arrows			Tot.	Set Points
1	X	10	10	30	2
2	10	9	9	28	2
3	9	9	9	27	2
4					
5					
					<b>6</b>

	Arrows			Tot.	Set Points
1	9	8	1	18	0
2	9	9	3	21	0
3	10	8	8	26	0
4					
5					
					<b>0</b>



**1/16 of Final Match**

Thu 30 Jun 2022 Starting Time: 09:15

Match Number 54

Target: 18A  
Athlete: **YILDIRMIS Muhammed (TUR - Turkey)**  
Bib: 31105

Target: 18B  
Athlete: **STEFANOVIC Mihajlo (SRB - Serbia)**  
Bib: 41943

	Arrows			Tot.	Set Points
1	9	8	8	25	0
2	9	8	7	24	0
3	10	9	9	28	2
4	7	7	7	21	0
5					
					<b>2</b>

Winner					
Set Points		Arrows			Tot.
2	1	9	9	8	26
2	2	10	9	9	28
0	3	10	9	8	27
2	4	9	8	8	25
	5				
					<b>6</b>



**1/16 of Final Match**

Thu 30 Jun 2022 Starting Time: 09:15

Match Number 55

Target: 19A  
Athlete: **ACHA Pablo (ESP - Spain)**  
Bib: 16213

Target: 19B  
Athlete: **KARAGEORGIU Alexandros (GRE - Greece)**  
Bib: 4016

**Winner**

	Arrows			Tot.	Set Points
1	9	8	7	24	2
2	X	10	9	29	2
3	X	9	9	28	2
4					
5					
					<b>6</b>

Set Points	Arrows			Tot.	
0	1	10	7	5	22
0	2	8	8	8	24
0	3	8	8	8	24
	4				
	5				
					<b>0</b>



**1/16 of Final Match**

Thu 30 Jun 2022 Starting Time: 09:15

Match Number 56

Target: 20A  
Athlete: **MATOS Tiago (POR - Portugal)**  
Bib: 23677

Target: 20B  
Athlete: **RAVNIKAR Ziga (SLO - Slovenia)**  
Bib: 15129

	Arrows			Tot.	Set Points
1	10	9	8	27	1
2	9	8	8	25	0
3	9	8	7	24	0
4	9	9	8	26	0
5					
					<b>1</b>

Winner					
Set Points		Arrows			Tot.
1	1	9	9	9	27
2	2	X	9	8	27
2	3	10	9	9	28
2	4	10	9	8	27
	5				
					<b>7</b>



**1/16 of Final Match**

Thu 30 Jun 2022 Starting Time: 09:15

Match Number 57

Target: 21A  
Athlete: **AK Samet (TUR - Turkey)**  
Bib: 23135

Target: 21B  
Athlete: **GONCALVES Luis (POR - Portugal)**  
Bib: 15463

**Winner**

	Arrows			Tot.	Set Points
1	9	9	9	27	2
2	10	9	9	28	2
3	10	9	8	27	2
4					
5					
					<b>6</b>

Set Points	Arrows			Tot.	
0	1	8	6	5	19
0	2	9	7	7	23
0	3	9	8	6	23
	4				
	5				
<b>0</b>					



**1/16 of Final Match**

Thu 30 Jun 2022 Starting Time: 09:15

Match Number 58

Target: 22A  
Athlete: **PANAGI Constantinos (CYP - Cyprus)**  
Bib: 15602

Target: 22B  
Athlete: **BERNARDI Nicolas (FRA - France)**  
Bib: 30447

	Arrows			Tot.	Set Points
1	9	8	8	25	0
2	9	8	8	25	0
3	10	9	8	27	0
4					
5					
					<b>0</b>

Winner					
Set Points		Arrows			Tot.
2	1	10	10	9	29
2	2	X	10	9	29
2	3	X	9	9	28
	4				
	5				
					<b>6</b>



**1/16 of Final Match**

Thu 30 Jun 2022 Starting Time: 09:15

Match Number 59

Target: 23A  
Athlete: **CARNEIRO Nuno (POR - Portugal)**  
Bib: 26737

Target: 23B  
Athlete: **CHARALAMBOUS Charalambos (CYP - Cyprus)**  
Bib: 11501

**Winner**

	Arrows			Tot.	Set Points
1	9	9	6	24	2
2	9	9	9	27	2
3	10	9	9	28	2
4					
5					
					<b>6</b>

Set Points	Arrows			Tot.	
0	1	10	7	6	23
0	2	8	8	8	24
0	3	10	8	7	25
	4				
	5				
<b>0</b>					



**1/16 of Final Match**

Thu 30 Jun 2022 Starting Time: 09:15

Match Number 60

Target: 24A  
Athlete: **BAKRI Imadeddine (ALG - Algeria)**  
Bib: 19825

Target: 24B  
Athlete: **HABJAN MALAVASIC Den (SLO - Slovenia)**  
Bib: 11964

**DNS**

	Arrows			Tot.	Set Points
1					
2					
3					
4					
5					

**0**

**Winner**

Set Points		Arrows			Tot.
	1				
	2				
	3				
	4				
	5				

**0**





**1/16 of Final Match**

Thu 30 Jun 2022 Starting Time: 09:15

Match Number 61

Target: 25A  
Athlete: **MUSOLESI Federico (ITA - Italy)**  
Bib: 17656

Target: 25B  
Athlete: **ALY Bahaaeldin (EGY - Egypt)**  
Bib: 23117

**Winner**

	Arrows			Tot.	Set Points
1	10	9	9	28	1
2	9	9	8	26	2
3	X	9	9	28	2
4	10	9	9	28	2
5					
					<b>7</b>

Set Points	Arrows			Tot.
1	10	10	8	28
0	9	9	5	23
0	9	9	8	26
0	7	7	5	19
<b>1</b>				



**1/16 of Final Match**

Thu 30 Jun 2022 Starting Time: 09:15

Match Number 62

Target: 26A  
Athlete: **ABDELBAR Aly (EGY - Egypt)**  
Bib: 16086

Target: 26B  
Athlete: **REMAR Alen (CRO - Croatia)**  
Bib: 15290

	Arrows			Tot.	Set Points
1	9	9	8	26	1
2	10	9	8	27	2
3	9	9	8	26	0
4	9	9	9	27	0
5	8	6	6	20	0
					<b>3</b>

Winner					
Set Points		Arrows			Tot.
1	1	10	9	7	26
0	2	9	9	8	26
2	3	X	10	8	28
2	4	X	10	10	30
2	5	10	9	8	27
					<b>7</b>



**1/16 of Final Match**

Thu 30 Jun 2022 Starting Time: 09:15

Match Number 63

Target: 27A  
Athlete: **PAOLI Alessandro (ITA - Italy)**  
Bib: 27225

Target: 27B  
Athlete: **GLLAREVA Valmir (KOS - Kosovo)**  
Bib: 41555

**Winner**

	Arrows			Tot.	Set Points
1	10	9	9	28	2
2	10	10	9	29	2
3	10	9	8	27	0
4	9	9	8	26	0
5	9	8	8	25	2
					<b>6</b>

Set Points	Arrows			Tot.	
0	1	9	9	7	25
0	2	9	8	8	25
2	3	X	10	10	30
2	4	10	9	8	27
0	5	10	8	6	24
					<b>4</b>



**1/16 of Final Match**

Thu 30 Jun 2022 Starting Time: 09:15

Match Number 64

Target: 28A  
Athlete: **HOCINE Abdelmajid (ALG - Algeria)**  
Bib: 16020

Target: 28B  
Athlete: **ALVARINO GARCIA Miguel (ESP - Spain)**  
Bib: 13410

	Arrows			Tot.	Set Points
1	10	8	7	25	0
2	9	8	8	25	0
3	10	8	8	26	0
4					
5					
					<b>0</b>

Winner					
Set Points		Arrows			Tot.
2	1	9	9	9	27
2	2	X	9	9	28
2	3	X	10	9	29
	4				
	5				
					<b>6</b>



**1/16 of Final Match**

Thu 30 Jun 2022 Starting Time: 09:15

Match Number 65

Target: 29A  
Athlete: **FICHET Romain (FRA - France)**  
Bib: 12391

Target: 29B  
Athlete: **PODKRAJŠEK Sergej (SLO - Slovenia)**  
Bib: 23131

**Winner**

	Arrows			Tot.	Set Points
1	X	9	8	27	2
2	9	9	9	27	2
3	10	10	9	29	2
4					
5					
					<b>6</b>

Set Points	Arrows			Tot.	
0	1	9	8	8	25
0	2	9	8	7	24
0	3	10	9	9	28
	4				
	5				
<b>0</b>					



**1/16 of Final Match**

Thu 30 Jun 2022 Starting Time: 09:15

Match Number 66

Target: 30A  
Athlete: **HAMMED Mohamed (TUN - Tunisia)**  
Bib: 14569

Target: 30B  
Athlete: **CASTRO Daniel (ESP - Spain)**  
Bib: 15489

	Arrows			Tot.	Set Points
1	8	8	7	23	0
2	10	9	9	28	0
3	10	9	8	27	0
4					
5					
					<b>0</b>

Winner					
Set Points		Arrows			Tot.
2	1	10	9	9	28
2	2	10	10	10	30
2	3	10	9	9	28
	4				
	5				
					<b>6</b>



**1/16 of Final Match**

Thu 30 Jun 2022 Starting Time: 09:15

Match Number 67

Target: 31A  
Athlete: **BARITEAUD Iban (FRA - France)**  
Bib: 41671

Target: 31B  
Athlete: **DVORANI Edi (KOS - Kosovo)**  
Bib: 22819

**Winner**

	Arrows			Tot.	Set Points
1	9	9	9	27	2
2	X	9	8	27	2
3	X	9	8	27	0
4	10	9	7	26	0
5	10	9	9	28	2
					<b>6</b>

Set Points	Arrows			Tot.	
0	1	10	8	8	26
0	2	9	9	8	26
2	3	10	9	9	28
2	4	9	9	9	27
0	5	X	9	5	24
					<b>4</b>



**1/16 of Final Match**

Thu 30 Jun 2022 Starting Time: 09:15

Match Number 68

Target: 32A  
Athlete: **RAHLAOUI Ayoub (ALG - Algeria)**  
Bib: 27774

Target: 32B  
Athlete: **NESPOLI Mauro (ITA - Italy)**  
Bib: 5796

	Arrows			Tot.	Set Points
1	10	10	9	29	0
2	9	8	6	23	0
3	9	8	5	22	0
4					
5					
					<b>0</b>

Winner					
Set Points		Arrows			Tot.
2	1	X	10	10	30
2	2	X	10	9	29
2	3	9	9	9	27
	4				
	5				
					<b>6</b>





**1/24 of Final Match**

Wed 29 Jun 2022 Starting Time: 12:00

Match Number 2

Target: 25A  
Athlete: **LOIZOU Konstantinos (CYP - Cyprus)**  
Bib: 9382

Target: 25B  
Athlete: **FORLANI Jacopo (SMR - San Marino)**  
Bib: 22689

**Winner**

	Arrows			Tot.	Set Points
1	X	8	7	25	2
2	9	8	7	24	2
3	8	7	4	19	0
4	9	9	8	26	2
5					
					<b>6</b>

Set Points	Arrows			Tot.	
0	1	9	9	5	23
0	2	8	7	3	18
2	3	9	9	6	24
0	4	8	7	5	20
	5				
					<b>2</b>



**1/24 of Final Match**

Wed 29 Jun 2022 Starting Time: 12:00

Match Number 15

Target: 26A  
Athlete: **BAKRI Imadeddine (ALG - Algeria)**  
Bib: 19825

Target: 26B  
Athlete: **ABORGIBA Majdi (LBA - Libya)**  
Bib: 5921

**Winner**

	Arrows			Tot.	Set Points
1	10	9	9	28	2
2	8	8	5	21	2
3	8	8	6	22	2
4					
5					
					<b>6</b>

Set Points	Arrows			Tot.
0	1	8	1	10
0	2	8	4	15
0	3	8	7	21
	4			
	5			
<b>0</b>				



**1/24 of Final Match**

Wed 29 Jun 2022 Starting Time: 12:00

Match Number 18

Target: 27A  
 Athlete: **EL RAYES Jacques (LBN - Lebanon)**  
 Bib: 13725

Target: 27B  
 Athlete: **ALY Bahaaeldin (EGY - Egypt)**  
 Bib: 23117

	Arrows			Tot.	Set Points
1	8	8	7	23	0
2	9	5	1	15	0
3	9	8	5	22	0
4					
5					
					<b>0</b>

Winner					
Set Points		Arrows			Tot.
2	1	X	9	7	26
2	2	8	8	4	20
2	3	X	10	9	29
	4				
	5				
					<b>6</b>



**1/24 of Final Match**

Wed 29 Jun 2022 Starting Time: 12:00

Match Number 31

Target: 28A  
Athlete: **RAHLAOUI Ayoub (ALG - Algeria)**  
Bib: 27774

Target: 28B  
Athlete: **ASLLANI Hazir (KOS - Kosovo)**  
Bib: 13737

**Winner**

	Arrows			Tot.	Set Points
1	8	8	5	21	0
2	9	8	6	23	2
3	10	7	7	24	2
4	9	9	7	25	2
5					
					<b>6</b>

Set Points	Arrows			Tot.	
2	1	9	9	8	26
0	2	8	6	4	18
0	3	X	7	3	20
0	4	X	10	3	23
	5				
					<b>2</b>



**Semifinal Match**

Thu 30 Jun 2022 Starting Time: 11:10

Match Number 109

Target: 23  
Athlete: **GAZUZ Mete (TUR - Turkey)**  
Bib: 13418

Target: 24  
Athlete: **BERNARDI Nicolas (FRA - France)**  
Bib: 30447

**Winner**

	Arrows			Tot.	Set Points
1	10	10	9	29	2
2	10	10	9	29	2
3	10	10	10	30	2
4					
5					
					<b>6</b>

	Arrows			Tot.	Set Points
1	10	8	6	24	0
2	10	9	8	27	0
3	10	9	9	28	0
4					
5					
					<b>0</b>



### Semifinal Match

Thu 30 Jun 2022 Starting Time: 11:10

Match Number 110

Target: 25  
Athlete: **MUSOLESI Federico (ITA - Italy)**  
Bib: 17656

Target: 26  
Athlete: **NESPOLI Mauro (ITA - Italy)**  
Bib: 5796

#### Winner

	Arrows			Tot.	Set Points
1	X	10	8	28	2
2	10	9	9	28	2
3	X	X	9	29	1
4	X	9	9	28	1
5					
					<b>6</b>

Set Points	Arrows			Tot.	
0	1	9	9	8	26
0	2	10	9	8	27
1	3	X	10	9	29
1	4	10	9	9	28
	5				
					<b>2</b>



## RESULTS SUMMARY

Rank	Name	NOC	
1	FERNANDEZ INFANTE Leyre	ESP	Spain
2	BOARI Lucilla	ITA	Italy
3	FLORENT Anaëlle	FRA	France
4	BASARAN Ezgi	TUR	Turkey
5	CANALES Elia	ESP	Spain
6	PSARRA Evangelia	GRE	Greece
7	COSKUN Gulnaz	TUR	Turkey
8	ANAGOZ Yasemin	TUR	Turkey
9	ANDREOLI Tatiana	ITA	Italy
	GKORILA Anatoli Martha	GRE	Greece
	HADJIEROTOCRITOU Christina	CYP	Cyprus
	KOUROUNA Mikaella	CYP	Cyprus
	MAUNIER Lucie	FRA	France
	REBAGLIATI Chiara	ITA	Italy
	UMER Ana	SLO	Slovenia
	VILLARD Laurena	FRA	France
17	AZZAM Nada	EGY	Egypt
	BAAYOU Maran	LBA	Libya
	BELLAL Yasmine	ALG	Algeria
	BRKIC Anja	SRB	Serbia
	CAVIC Urska	SLO	Slovenia
	COREL Nina	SLO	Slovenia
	ELWALID Rihab	TUN	Tunisia
	NASOULA Maria	GRE	Greece
	PETROU Elena	CYP	Cyprus
	UNAMUNZAGA ALTUNA Irati	ESP	Spain
	YASSEN Israa	EGY	Egypt



## RESULT BRACKETS

R. Round Rank/Score	Name	NOC Code	Quarterfinals	Semifinals	Finals	
1/ 649	ANAGOZ Yasemin	TUR	1 (26,26,25,27)	FERNANDEZ INFANTE L (ESP)		
8/ 635	FERNANDEZ INFANTE Leyre	ESP	7 (29,26,27,29)	6 (27,26,26,24,25-T. 9)	FERNANDEZ INFANTE L (ESP)	
5/ 641	BASARAN Ezgi	TUR	6 (29,25,28,28,29)	BASARAN E (TUR)	7 (24,25,25,28)	<b>GOLD</b>
4/ 642	CANALES Elia	ESP	4 (29,28,25,28,27)	5 (25,25,27,28,25-T. 8)		FERNANDEZ INFANTE L (ESP)
14/ 624	FLORENT Anaëlle	FRA	7 (28,27,25,25,29)	FLORENT A (FRA)		
6/ 638	COSKUN Gulnaz	TUR	3 (24,26,25,28,28)	0 (21,24,26)	BOARI L (ITA)	
7/ 637	BOARI Lucilla	ITA	6 (26,28,24,24,29)	BOARI L (ITA)	1 (24,24,19,25)	<b>SILVER</b>
15/ 616	PSARRA Evangelia	GRE	4 (27,27,19,27,26)	6 (28,30,27)		BOARI L (ITA)
					BASARAN E (TUR)	
					3 (23,22,25,27,21)	<b>BRONZE</b>
					FLORENT A (FRA)	FLORENT A (FRA)
					7 (24,21,25,28,25)	

### Final Rank

1	FERNANDEZ INFANTE Leyre	ESP	
2	BOARI Lucilla	ITA	
3	FLORENT Anaëlle	FRA	
4	BASARAN Ezgi	TUR	
5	CANALES Elia	ESP	4 (137)
6	PSARRA Evangelia	GRE	4 (126)
7	COSKUN Gulnaz	TUR	3 (131)
8	ANAGOZ Yasemin	TUR	1 (104)





## RESULT BRACKETS

R. Round Rank/Score	Name	NOC Code	1/16 Elimin. Round	1/8 Elimin. Round	Quarterfinals
1/ 649	<b>ANAGOZ Yasemin</b> -Bye-	TUR		<b>ANAGOZ Y (TUR)</b> 6 (29,29,28)	ANAGOZ Y (TUR)
17/ 604	PETROU Elena	CYP	1 (25,23,27,25)	MAUNIER L (FRA) 0 (27,25,27)	1 (26,26,25,27)
16/ 614	<b>MAUNIER Lucie</b>	FRA	7 (27,28,27,28)		
9/ 634	<b>ANDREOLI Tatiana</b>	ITA	6 (26,28,28,27)	ANDREOLI T (ITA) 2 (28,26,26,27)	<b>FERNANDEZ INFANTE L (ESP)</b> 7 (29,26,27,29)
24/ 568	AZZAM Nada	EGY	2 (27,25,24,23)		
25/ 545	BRKIC Anja	SRB	1 (26,24,21,25)	<b>FERNANDEZ INFANTE L (ESP)</b> 6 (28,27,28,27)	
8/ 635	<b>FERNANDEZ INFANTE Leyre</b>	ESP	7 (26,27,27,27)		
5/ 641	<b>BASARAN Ezgi</b> -Bye-	TUR		<b>BASARAN E (TUR)</b> 6 (21,25,27,28)	<b>BASARAN E (TUR)</b> 6 (29,25,28,28,29)
21/ 594	<b>HADJIEROTOCRITOU Christina</b>	CYP	6 (25,27,26,27,25)	HADJIEROTOCRITOU C (CYP) 2 (19,25,27,27)	
12/ 628	ELWALID Rihab	TUN	4 (25,23,26,27,25)		
13/ 627	<b>VILLARD Laurena</b>	FRA	6 (26,26,27,25,22-T. 10+)	VILLARD L (FRA) 4 (28,26,28,26,25)	<b>CANALES E (ESP)</b> 4 (29,28,25,28,27)
20/ 596	UNAMUNZAGA ALTUNA Irati	ESP	5 (24,28,24,27,22-T. 10)		
4/ 642	-Bye- <b>CANALES Elia</b>	ESP		<b>CANALES E (ESP)</b> 6 (26,27,27,27,27)	
3/ 643	<b>UMER Ana</b> -Bye-	SLO		UMER A (SLO) DNS	<b>FLORENT A (FRA)</b> 7 (28,27,25,25,29)
19/ 601	COREL Nina	SLO	DNS	<b>FLORENT A (FRA)</b>	
14/ 624	<b>FLORENT Anaëlle</b>	FRA			
11/ 629	<b>REBAGLIATI Chiara</b>	ITA	6 (28,26,24,26)	REBAGLIATI C (ITA) 0 (23,24,26)	<b>COSKUN G (TUR)</b> 3 (24,26,25,28,28)
22/ 583	BELLAL Yasmine	ALG	2 (26,22,26,20)		
27/ 385	BAAYOU Maran	LBA	0 (20,21,22)	<b>COSKUN G (TUR)</b> 6 (28,28,29)	
6/ 638	<b>COSKUN Gulnaz</b>	TUR	6 (25,28,26)		
7/ 637	<b>BOARI Lucilla</b>	ITA	6 (26,29,27)	<b>BOARI L (ITA)</b> 6 (25,28,28,27)	<b>BOARI L (ITA)</b> 6 (26,28,24,24,29)
26/ 524	YASSEN Israa	EGY	0 (18,16,15)		
23/ 583	<b>KOUROUNA Mikaella</b>	CYP	6 (27,25,27,27,27)	KOUROUNA M (CYP) 2 (26,25,27,25)	
10/ 630	NASOULA Maria	GRE	4 (25,25,28,27,25)		
15/ 616	<b>PSARRA Evangelia</b>	GRE	7 (28,28,27,28)	<b>PSARRA E (GRE)</b> 6 (21,26,27,28)	<b>PSARRA E (GRE)</b> 4 (27,27,19,27,26)
18/ 603	CAVIC Urska	SLO	1 (26,25,27,24)		
2/ 644	-Bye- <b>GKORILA Anatoli Martha</b>	GRE		GKORILA AM (GRE) 2 (27,21,24,26)	



RESULTS

OFFICIAL After 72 Arrows

World Record 70 metres Round: 692 KANG Chae Young KOR 's-Hertogenbosch (NED) 2019-06-10

Rank	Back No.	Name	NOC	70m-1	70m-2	10+X's	X's	Score
1	6A	ANAGOZ Yasemin	TUR	330 / 1	319 / 5	26	6	649
2	1B	GKORILA Anatoli Martha	GRE	317 / 11	327 / 1	24	8	644
3	11A	UMER Ana	SLO	323 / 6	320 / 4	20	7	643
4	2A	CANALES Elia	ESP	325 / 4	317 / 6	19	8	642
5	4A	BASARAN Ezgi	TUR	318 / 10	323 / 3	27	7	641
6	5A	COSKUN Gulnaz	TUR	322 / 8	316 / 8	18	5	638
7	8A	BOARI Lucilla	ITA	327 / 3	310 / 13	22	5	637
8	3A	FERNANDEZ INFANTE Leyre	ESP	320 / 9	315 / 9	18	5	635
9	7A	ANDREOLI Tatiana	ITA	323 / 7	311 / 12	15	8	634
10	2B	NASOULA Maria	GRE	304 / 18	326 / 2	17	7	630
11	9A	REBAGLIATI Chiara	ITA	325 / 4	304 / 15	19	4	629
12	12B	ELWALID Rihab	TUN	327 / 2	301 / 17	22	4	628
13	5B	VILLARD Laurena	FRA	312 / 12	315 / 10	15	3	627
14	4B	FLORENT Ana�lle	FRA	308 / 14	316 / 7	18	6	624
15	3B	PSARRA Evangelia	GRE	305 / 17	311 / 11	10	3	616
16	6B	MAUNIER Lucie	FRA	304 / 19	310 / 14	13	5	614
17	9B	PETROU Elena	CYP	305 / 16	299 / 19	11	2	604
18	10A	CAVIC Urska	SLO	300 / 20	303 / 16	17	6	603
19	12A	COREL Nina	SLO	305 / 15	296 / 21	11	4	601
20	1A	UNAMUNZAGA ALTUNA Irati	ESP	299 / 21	297 / 20	8	3	596
21	8B	HADJIEROTOCRITOU Christina	CYP	309 / 13	285 / 24	11	3	594
22	14A	BELLAL Yasmine	ALG	297 / 22	286 / 23	11	3	583
23	7B	KOUROUNA Mikaella	CYP	283 / 23	300 / 18	9	1	583
24	11B	AZZAM Nada	EGY	278 / 24	290 / 22	8	3	568
25	13A	BRKIC Anja	SRB	276 / 25	269 / 26	5	2	545
26	10B	YASSEN Israa	EGY	252 / 26	272 / 25	9	0	524
27	13B	BAAYOU Maran	LBA	185 / 27	200 / 27	3	0	385



**Eighth of Final Match**

Thu 30 Jun 2022 Starting Time: 09:55

Match Number 93

Target: 5A  
Athlete: **ANAGOZ Yasemin (TUR - Turkey)**  
Bib: 13417

Target: 5B  
Athlete: **MAUNIER Lucie (FRA - France)**  
Bib: 41669

**Winner**

	Arrows			Tot.	Set Points
1	X	10	9	29	2
2	10	10	9	29	2
3	X	10	8	28	2
4					
5					
					<b>6</b>

Set Points	Arrows			Tot.	
0	1	10	9	8	27
0	2	9	8	8	25
0	3	X	9	8	27
	4				
	5				
<b>0</b>					



### Eighth of Final Match

Thu 30 Jun 2022 Starting Time: 09:55

Match Number 94

Target: 6A  
Athlete: **ANDREOLI Tatiana (ITA - Italy)**  
Bib: 15084

Target: 6B  
Athlete: **FERNANDEZ INFANTE Leyre (ESP - Spain)**  
Bib: 27424

	Arrows			Tot.	Set Points
1	10	9	9	28	1
2	10	8	8	26	0
3	X	9	7	26	0
4	9	9	9	27	1
5					
					<b>2</b>

Winner					
Set Points	Arrows			Tot.	
1	1	10	9	9	28
2	2	9	9	9	27
2	3	10	9	9	28
1	4	X	9	8	27
	5				
					<b>6</b>



**Eighth of Final Match**

Thu 30 Jun 2022 Starting Time: 09:55

Match Number 95

Target: 7A  
Athlete: **BASARAN Ezgi (TUR - Turkey)**  
Bib: 23134

Target: 7B  
Athlete: **HADJIEROTCRITOU Christina (CYP - Cyprus)**  
Bib: 12616

**Winner**

	Arrows			Tot.	Set Points
1	8	7	6	21	2
2	9	8	8	25	1
3	10	9	8	27	1
4	X	9	9	28	2
5					
					<b>6</b>

Set Points	Arrows			Tot.	
0	1	7	6	6	19
1	2	9	8	8	25
1	3	10	9	8	27
0	4	10	9	8	27
	5				
					<b>2</b>



**Eighth of Final Match**

Thu 30 Jun 2022 Starting Time: 09:55

Match Number 96

Target: 8A  
Athlete: **VILLARD Laurena (FRA - France)**  
Bib: 16365

Target: 8B  
Athlete: **CANALES Elia (ESP - Spain)**  
Bib: 20839

	Arrows			Tot.	Set Points
1	10	9	9	28	2
2	10	9	7	26	0
3	10	10	8	28	2
4	9	9	8	26	0
5	9	9	7	25	0
					<b>4</b>

Winner					
Set Points	Arrows			Tot.	
0	1	9	9	8	26
2	2	10	9	8	27
0	3	10	9	8	27
2	4	10	9	8	27
2	5	10	9	8	27
					<b>6</b>



**Eighth of Final Match**

Thu 30 Jun 2022 Starting Time: 09:55

Match Number 98

Target: 10A  
Athlete: **REBAGLIATI Chiara (ITA - Italy)**  
Bib: 16298

Target: 10B  
Athlete: **COSKUN Gulnaz (TUR - Turkey)**  
Bib: 17346

	Arrows			Tot.	Set Points
1	8	8	7	23	0
2	8	8	8	24	0
3	10	8	8	26	0
4					
5					
					<b>0</b>

Winner					
Set Points		Arrows			Tot.
2	1	10	10	8	28
2	2	X	9	9	28
2	3	X	10	9	29
	4				
	5				
					<b>6</b>



**Eighth of Final Match**

Thu 30 Jun 2022 Starting Time: 09:55

Match Number 99

Target: 11A  
Athlete: **BOARI Lucilla (ITA - Italy)**  
Bib: 9148

Target: 11B  
Athlete: **KOUROUNA Mikaella (CYP - Cyprus)**  
Bib: 11504

**Winner**

	Arrows			Tot.	Set Points
1	10	8	7	25	0
2	10	9	9	28	2
3	10	10	8	28	2
4	10	9	8	27	2
5					
					<b>6</b>

	Arrows			Tot.	Set Points
1	10	9	7	26	2
2	10	8	7	25	0
3	X	9	8	27	0
4	9	8	8	25	0
5					
					<b>2</b>





### Eighth of Final Match

Thu 30 Jun 2022 Starting Time: 09:55

Match Number 100

Target: 12A  
Athlete: **PSARRA Evangelia (GRE - Greece)**  
Bib: 424

Target: 12B  
Athlete: **GKORILA Anatoli Martha (GRE - Greece)**  
Bib: 14172

#### Winner

	Arrows			Tot.	Set Points
1	7	7	7	21	0
2	X	8	8	26	2
3	9	9	9	27	2
4	X	9	9	28	2
5					
					<b>6</b>

Set Points		Arrows			Tot.
2	1	X	9	8	27
0	2	9	7	5	21
0	3	8	8	8	24
0	4	10	9	7	26
	5				
<b>2</b>					



### Gold Medal Match

Fri 1 Jul 2022 Starting Time: 14:45

Match Number 134

Target: 1  
Athlete: **FERNANDEZ INFANTE Leyre (ESP - Spain)**  
Bib: 27424

Target: 2  
Athlete: **BOARI Lucilla (ITA - Italy)**  
Bib: 9148

#### Winner

	Arrows			Tot.	Set Points
1	6	9	9	24	1
2	7	9	9	25	2
3	10	8	7	25	2
4	9	10	9	28	2
5					

7

	Arrows			Tot.	Set Points
1	10	4	10	24	1
2	7	10	7	24	0
3	6	6	7	19	0
4	10	6	9	25	0
5					

1

Line Judge: LAMANDÉ Khaled Sofiane

Target Judge: LEONIDOU Eleni



### Bronze Medal Match

Fri 1 Jul 2022 Starting Time: 14:30

Match Number 133

Target: 1  
Athlete: **BASARAN Ezgi (TUR - Turkey)**  
Bib: 23134

Target: 2  
Athlete: **FLORENT Anaëlle (FRA - France)**  
Bib: 19935

	Arrows			Tot.
1	9	4	10	23
2	7	8	7	22
3	8	9	8	25
4	9	9	9	27
5	4	8	9	21

Set Points
0
2
1
0
0

**3**

### Winner

	Arrows			Tot.
1	10	4	10	24
2	9	8	4	21
3	10	7	8	25
4	9	9	10	28
5	10	8	7	25

Set Points
2
0
1
2
2

**7**

Line Judge: ZURBANO Irati

Target Judge: LEONIDOU Eleni



**Quarterfinal Match**

Thu 30 Jun 2022 Starting Time: 10:35

Match Number 105

Target: 5  
Athlete: **ANAGOZ Yasemin (TUR - Turkey)**  
Bib: 13417

Target: 6  
Athlete: **FERNANDEZ INFANTE Leyre (ESP - Spain)**  
Bib: 27424

	Arrows			Tot.	Set Points
1	9	9	8	26	0
2	9	9	8	26	1
3	9	8	8	25	0
4	10	9	8	27	0
5					
					<b>1</b>

Winner					
Set Points	Arrows			Tot.	
2	1	10	10	9	29
1	2	9	9	8	26
2	3	9	9	9	27
2	4	10	10	9	29
	5				
					<b>7</b>



### Quarterfinal Match

Thu 30 Jun 2022 Starting Time: 10:35

Match Number 106

Target: 7  
Athlete: **BASARAN Ezgi (TUR - Turkey)**  
Bib: 23134

Target: 8  
Athlete: **CANALES Elia (ESP - Spain)**  
Bib: 20839

#### Winner

	Arrows			Tot.	Set Points
1	10	10	9	29	1
2	9	8	8	25	0
3	10	9	9	28	2
4	10	9	9	28	1
5	X	10	9	29	2
					<b>6</b>

	Arrows			Tot.	Set Points
1	X	10	9	29	1
2	10	9	9	28	2
3	9	8	8	25	0
4	10	9	9	28	1
5	9	9	9	27	0
					<b>4</b>



### Quarterfinal Match

Thu 30 Jun 2022 Starting Time: 10:35

Match Number 107

Target: 9  
Athlete: **FLORENT Anaëlle (FRA - France)**  
Bib: 19935

Target: 10  
Athlete: **COSKUN Gulnaz (TUR - Turkey)**  
Bib: 17346

#### Winner

	Arrows			Tot.	Set Points
1	X	9	9	28	2
2	10	9	8	27	2
3	9	8	8	25	1
4	10	8	7	25	0
5	X	10	9	29	2
					<b>7</b>

Set Points	Arrows			Tot.	
0	1	9	8	7	24
0	2	9	9	8	26
1	3	10	8	7	25
2	4	X	9	9	28
0	5	10	9	9	28
					<b>3</b>



### Quarterfinal Match

Thu 30 Jun 2022 Starting Time: 10:35

Match Number 108

Target: 11  
Athlete: **BOARI Lucilla (ITA - Italy)**  
Bib: 9148

Target: 12  
Athlete: **PSARRA Evangelia (GRE - Greece)**  
Bib: 424

#### Winner

	Arrows			Tot.	Set Points
1	9	9	8	26	0
2	X	9	9	28	2
3	9	8	7	24	2
4	9	8	7	24	0
5	10	10	9	29	2
					<b>6</b>

Set Points	Arrows			Tot.	
2	1	10	10	7	27
0	2	9	9	9	27
0	3	8	6	5	19
2	4	9	9	9	27
0	5	10	8	8	26
					<b>4</b>



**1/16 of Final Match**

Thu 30 Jun 2022 Starting Time: 09:15

Match Number 70

Target: 2A  
Athlete: **PETROU Elena (CYP - Cyprus)**  
Bib: 36477

Target: 2B  
Athlete: **MAUNIER Lucie (FRA - France)**  
Bib: 41669

	Arrows			Tot.	Set Points
1	9	8	8	25	0
2	8	8	7	23	0
3	X	9	8	27	1
4	10	9	6	25	0
5					
					<b>1</b>

Winner					
Set Points		Arrows			Tot.
2	1	X	9	8	27
2	2	10	9	9	28
1	3	10	9	8	27
2	4	X	9	9	28
	5				
					<b>7</b>





**1/16 of Final Match**

Thu 30 Jun 2022 Starting Time: 09:15

Match Number 71

Target: 3A  
Athlete: **ANDREOLI Tatiana (ITA - Italy)**  
Bib: 15084

Target: 3B  
Athlete: **AZZAM Nada (EGY - Egypt)**  
Bib: 23114

**Winner**

	Arrows			Tot.	Set Points
1	10	8	8	26	0
2	10	9	9	28	2
3	X	10	8	28	2
4	X	10	7	27	2
5					
					<b>6</b>

Set Points	Arrows			Tot.	
2	1	X	9	8	27
0	2	9	9	7	25
0	3	9	9	6	24
0	4	9	8	6	23
	5				
					<b>2</b>



**1/16 of Final Match**

Thu 30 Jun 2022 Starting Time: 09:15

Match Number 72

Target: 4A  
Athlete: **BRKIC Anja (SRB - Serbia)**  
Bib: 37656

Target: 4B  
Athlete: **FERNANDEZ INFANTE Leyre (ESP - Spain)**  
Bib: 27424

	Arrows			Tot.	Set Points
1	9	9	8	26	1
2	9	9	6	24	0
3	9	8	4	21	0
4	X	8	7	25	0
5					
					<b>1</b>

Winner					
Set Points	Arrows			Tot.	
1	1	10	8	8	26
2	2	X	9	8	27
2	3	9	9	9	27
2	4	9	9	9	27
	5				
					<b>7</b>



**1/16 of Final Match**

Thu 30 Jun 2022 Starting Time: 09:15

Match Number 74

Target: 6A  
Athlete: **HADJIEROTOCRITOU Christina (CYP - Cyprus)**  
Bib: 12616

Target: 6B  
Athlete: **ELWALID Rihab (TUN - Tunisia)**  
Bib: 31225

**Winner**

	Arrows			Tot.	Set Points
1	10	8	7	25	1
2	10	9	8	27	2
3	9	9	8	26	1
4	9	9	9	27	1
5	10	8	7	25	1

**6**

Set Points	Arrows			Tot.	
1	1	10	8	7	25
0	2	8	8	7	23
1	3	9	9	8	26
1	4	10	9	8	27
1	5	9	8	8	25

**4**



**1/16 of Final Match**

Thu 30 Jun 2022 Starting Time: 09:15

Match Number 75

Target: 7A  
Athlete: **VILLARD Laurena (FRA - France)**  
Bib: 16365

Target: 7B  
Athlete: **UNAMUNZAGA ALTUNA Irati (ESP - Spain)**  
Bib: 42211

**Winner**

	Arrows			Tot.	Set Points
1	X	9	7	26	2
2	9	9	8	26	0
3	X	9	8	27	2
4	9	9	7	25	0
5	8	8	6	22	1

S.O. 1 | 10

Closest to the center

1

**6**

Set Points	Arrows			Tot.	
0	1	10	9	5	24
2	2	10	9	9	28
0	3	X	8	6	24
2	4	9	9	9	27
1	5	8	8	6	22

0

**5**

S.O. 1 | 10



**1/16 of Final Match**

Thu 30 Jun 2022 Starting Time: 09:15

Match Number 79

Target: 11A  
Athlete: **REBAGLIATI Chiara (ITA - Italy)**  
Bib: 16298

Target: 11B  
Athlete: **BELLAL Yasmine (ALG - Algeria)**  
Bib: 23667

**Winner**

	Arrows			Tot.	Set Points
1	10	9	9	28	2
2	10	8	8	26	2
3	9	8	7	24	0
4	9	9	8	26	2
5					
					<b>6</b>

Set Points		Arrows			Tot.
0	1	X	8	8	26
0	2	8	8	6	22
2	3	10	9	7	26
0	4	7	7	6	20
	5				
<b>2</b>					



**1/16 of Final Match**

Thu 30 Jun 2022 Starting Time: 09:15

Match Number 80

Target: 12A  
Athlete: **BAAYOU Maran (LBA - Libya)**  
Bib: 45330

Target: 12B  
Athlete: **COSKUN Gulnaz (TUR - Turkey)**  
Bib: 17346

	Arrows			Tot.	Set Points
1	9	6	5	20	0
2	8	7	6	21	0
3	10	6	6	22	0
4					
5					
					<b>0</b>

Winner					
Set Points		Arrows			Tot.
2	1	9	8	8	25
2	2	10	9	9	28
2	3	9	9	8	26
	4				
	5				
					<b>6</b>



**1/16 of Final Match**

Thu 30 Jun 2022 Starting Time: 09:15

Match Number 81

Target: 13A  
Athlete: **BOARI Lucilla (ITA - Italy)**  
Bib: 9148

Target: 13B  
Athlete: **YASSEN Israa (EGY - Egypt)**  
Bib: 23904

**Winner**

	Arrows			Tot.	Set Points
1	9	9	8	26	2
2	10	10	9	29	2
3	10	9	8	27	2
4					
5					
					<b>6</b>

Set Points	Arrows			Tot.	
0	1	7	6	5	18
0	2	8	7	1	16
0	3	6	5	4	15
	4				
	5				
<b>0</b>					



**1/16 of Final Match**

Thu 30 Jun 2022 Starting Time: 09:15

Match Number 82

Target: 14A  
Athlete: **KOUROUNA Mikaella (CYP - Cyprus)**  
Bib: 11504

Target: 14B  
Athlete: **NASOULA Maria (GRE - Greece)**  
Bib: 30739

**Winner**

	Arrows			Tot.	Set Points
1	10	10	7	27	2
2	10	9	6	25	1
3	X	9	8	27	0
4	X	X	7	27	1
5	10	9	8	27	2
					<b>6</b>

Set Points	Arrows			Tot.	
0	1	9	9	7	25
1	2	9	9	7	25
2	3	X	9	9	28
1	4	9	9	9	27
0	5	9	9	7	25
					<b>4</b>





**1/16 of Final Match**

Thu 30 Jun 2022 Starting Time: 09:15

Match Number 83

Target: 15A  
 Athlete: **PSARRA Evangelia (GRE - Greece)**  
 Bib: 424

Target: 15B  
 Athlete: **CAVIC Urska (SLO - Slovenia)**  
 Bib: 3379

**Winner**

	Arrows			Tot.	Set Points
1	X	10	8	28	2
2	10	9	9	28	2
3	10	10	7	27	1
4	X	10	8	28	2
5					
					<b>7</b>

	Arrows			Tot.	Set Points
1	X	9	7	26	0
2	9	8	8	25	0
3	10	9	8	27	1
4	9	8	7	24	0
5					
					<b>1</b>



### Semifinal Match

Thu 30 Jun 2022 Starting Time: 11:10

Match Number 111

Target: 7  
 Athlete: **FERNANDEZ INFANTE Leyre (ESP - Spain)**  
 Bib: 27424

Target: 8  
 Athlete: **BASARAN Ezgi (TUR - Turkey)**  
 Bib: 23134

#### Winner

	Arrows			Tot.	Set Points
1	9	9	9	27	2
2	10	8	8	26	2
3	X	8	8	26	0
4	8	8	8	24	0
5	9	9	7	25	1

S.O. 1	9
--------	---

1
---

6
---

Set Points	Arrows			Tot.	
0	1	9	9	7	25
0	2	9	8	8	25
2	3	10	9	8	27
2	4	10	9	9	28
1	5	9	8	8	25

0
---

5
---

S.O. 1	8
--------	---



### Semifinal Match

Thu 30 Jun 2022 Starting Time: 11:10  
Match Number 112

Target: 9  
Athlete: **FLORENT Anaëlle (FRA - France)**  
Bib: 19935

Target: 10  
Athlete: **BOARI Lucilla (ITA - Italy)**  
Bib: 9148

	Arrows			Tot.	Set Points
1	8	7	6	21	0
2	9	8	7	24	0
3	X	10	6	26	0
4					
5					
					<b>0</b>

Winner					
Set Points		Arrows			Tot.
2	1	X	9	9	28
2	2	10	10	10	30
2	3	9	9	9	27
	4				
	5				
					<b>6</b>



## RESULTS SUMMARY

Rank	NOC	Name
1	FRA	France BARITEAUD Iban BERNARDI Nicolas FICHET Romain
2	ESP	Spain ACHA Pablo ALVARINO GARCIA Miguel CASTRO Daniel
3	TUR	Turkey AK Samet GAZOZ Mete YILDIRMIS Muhammed
4	ITA	Italy MUSOLESI Federico NESPOLI Mauro PAOLI Alessandro
5	CYP	Cyprus CHARALAMBOUS Charalambos LOIZOU Konstantinos PANAGI Constantinos
6	POR	Portugal CARNEIRO Nuno GONCALVES Luis MATOS Tiago
7	ALG	Algeria BAKRI Imadeddine HOCINE Abdelmajid RAHLAOUI Ayoub
8	SLO	Slovenia HABJAN MALAVASIC Den PODKRAJŠEK Sergej RAVNIKAR Ziga
9	KOS	Kosovo ASLLANI Hazir DVORANI Edi GLLAREVA Valmir



RESULT BRACKETS

R. Round Rank/Score	NOC	Name	1/8 Elimin. Round	1/4 Elimin. Round	Semifinals	Finals
1/ 1969	ITA	<b>Italy</b> MUSOLESI Federico NESPOLI Mauro PAOLI Alessandro	-Bye-	<b>Italy</b> 6 (53,57,56)	<b>Italy</b> 0 (50,51,51)	<b>Final Rank</b> 1 FRA France 2 ESP Spain 3 TUR Turkey 4 ITA Italy 5 CYP Cyprus 0 (148) 6 POR Portugal 0 (143) 7 ALG Algeria 0 (140) 8 SLO Slovenia
9/ 1751	KOS	Kosovo ASLLANI Hazir DVORANI Edi GLLAREVA Valmir	0 (49,43,46)	Cyprus		
8/ 1766	CYP	<b>Cyprus</b> CHARALAMBOUS Charalambos LOIZOU Konstantinos PANAGI Constantinos	6 (52,50,48)	0 (52,50,46)		
5/ 1907	SLO	<b>Slovenia</b> HABJAN MALAVASIC Den PODKRAJŠEK Sergej RAVNIKAR Ziga	-Bye-	Slovenia DNS		
			-Bye-		<b>France</b> 6 (52,50,54,53)	
4/ 1920	FRA	<b>France</b> BARITEAUD Iban BERNARDI Nicolas FICHET Romain		<b>France</b>		
3/ 1938	ESP	<b>Spain</b> ACHA Pablo ALVARINO GARCIA Miguel CASTRO Daniel	-Bye-	<b>Spain</b> 6 (47,55,56)		
			-Bye-		<b>Spain</b> 6 (51,55,58,56)	
6/ 1835	POR	<b>Portugal</b> CARNEIRO Nuno GONCALVES Luis MATOS Tiago		Portugal 0 (40,50,53)		
7/ 1774	ALG	<b>Algeria</b> BAKRI Imadeddine HOCINE Abdelmajid RAHLAOUI Ayoub	-Bye-	Algeria 0 (46,48,46)		
			-Bye-		Turkey 2 (53,52,54,53)	
2/ 1952	TUR	<b>Turkey</b> AK Samet GAZOZ Mete YILDIRMIS Muhammed		<b>Turkey</b> 6 (50,54,51)		
					Italy 4 (57,49,58,53-T.26)	
					<b>Turkey</b> 5 (56,51,52,55-T.28)	
					<b>GOLD</b> France	
					<b>SILVER</b> Spain	
					<b>BRONZE</b> Turkey	



**RESULTS**

OFFICIAL After 216 Arrows

World Record 70 metres Round: 2087 IM Dong Hyun/KIM Bubmin/OH Jin Hyek KOR London (GBR) 2012-07-27

Rank	NOC	Name	Individual Total	Team Total
1	ITA - Italy	MUSOLESI Federico NESPOLI Mauro PAOLI Alessandro	661 667 641	1969
2	TUR - Turkey	AK Samet GAZOZ Mete YILDIRMIS Muhammed	654 670 628	1952
3	ESP - Spain	ACHA Pablo ALVARINO GARCIA Miguel CASTRO Daniel	643 653 642	1938
4	FRA - France	BARITEAUD Iban BERNARDI Nicolas FICHET Romain	632 639 649	1920
5	SLO - Slovenia	HABJAN MALAVASIC Den PODKRAJŠEK Sergej RAVNIKAR Ziga	657 601 649	1907
6	POR - Portugal	CARNEIRO Nuno GONCALVES Luis MATOS Tiago	633 596 606	1835
7	ALG - Algeria	BAKRI Imadeddine HOCINE Abdelmajid RAHLAOUI Ayoub	596 598 580	1774
8	CYP - Cyprus	CHARALAMBOUS Charalambos LOIZOU Konstantinos PANAGI Constantinos	617 532 617	1766
9	KOS - Kosovo	ASLLANI Hazir DVORANI Edi GLLAREVA Valmir	515 622 614	1751



### Eighth of Final Match

Wed 29 Jun 2022 Starting Time: 15:15

Match Number 34

Target: 17  
Country Code: **KOS**  
Country: **Kosovo**

Target: 18  
Country Code: **CYP**  
Country: **Cyprus**

	Arrows						Tot.
1	9	9	9	8	7	7	49
2	9	9	9	6	5	5	43
3	9	9	8	8	7	5	46
4							

Set Points
0
0
0
<b>0</b>

### Winner

Set Points	Arrows						Tot.	
2	1	X	10	9	8	8	7	52
2	2	10	9	9	9	7	6	50
2	3	9	9	8	8	8	6	48
	4							

<b>6</b>
----------

### Gold Medal Match

Fri 1 Jul 2022 Starting Time: 10:55

Match Number 130

Target: 1  
Country Code: **FRA**  
Country: **France**

Target: 2  
Country Code: **ESP**  
Country: **Spain**

#### Winner

	Arrows						Tot.
1	9	10	7	8	9	9	52
2	8	9	9	8	8	8	50
3	9	10	8	8	9	10	54
4	8	9	9	10	9	8	53

Set Points
2
2
0
2

**6**

Set Points
0
0
2
0

**2**

	Arrows						Tot.
1	8	7	8	9	9	10	51
2	8	9	7	9	7	9	49
3	9	10	8	9	9	10	55
4	9	9	10	9	6	9	52

Line Judge: LAMANDÉ Khaled Sofiane

Target Judge: KOURA Ahmed



### Bronze Medal Match

Fri 1 Jul 2022 Starting Time: 10:30

Match Number 129

Target: 1  
Country Code: **ITA**  
Country: **Italy**

Target: 2  
Country Code: **TUR**  
Country: **Turkey**

	Arrows						Tot.
1	8	10	10	9	10	10	57
2	7	8	10	9	7	8	49
3	10	9	10	9	10	10	58
4	9	10	8	8	8	10	53
S.O.1	9	8	9				26

Set Points
2
0
2
0
0
0

**4**

### Winner

	Arrows						Tot.
1	10	9	9	10	9	9	56
2	10	8	10	9	9	5	51
3	7	10	8	9	9	9	52
4	9	8	9	10	10	9	55
S.O.1	9	10	9				28

**5**

Line Judge: ZURBANO Irati

Target Judge: KOURA Ahmed

### Quarterfinal Match

Wed 29 Jun 2022 Starting Time: 15:45

Match Number 41

Target: 17  
Country Code: **ITA**  
Country: **Italy**

Target: 18  
Country Code: **CYP**  
Country: **Cyprus**

#### Winner

	Arrows						Tot.	Set Points
1	9	9	9	9	9	8	53	2
2	X	10	10	9	9	9	57	2
3	X	X	X	9	9	8	56	2
4								
								<b>6</b>

	Arrows						Tot.	Set Points
1	10	9	9	8	8	8	52	0
2	9	9	9	9	7	7	50	0
3	9	8	8	7	7	7	46	0
4								
								<b>0</b>



### Quarterfinal Match

Wed 29 Jun 2022 Starting Time: 15:45

Match Number 42

Target: 20  
Country Code: **SLO**  
Country: **Slovenia**

Target: 21  
Country Code: **FRA**  
Country: **France**

#### DNS

	Arrows					Tot.	Set Points
1							
2							
3							
4							

0

#### Winner

Set Points		Arrows					Tot.
	1						
	2						
	3						
	4						

0



### Quarterfinal Match

Wed 29 Jun 2022 Starting Time: 15:45

Match Number 43

Target: 23  
Country Code: **ESP**  
Country: **Spain**

Target: 24  
Country Code: **POR**  
Country: **Portugal**

Winner

	Arrows						Tot.	Set Points
1	9	8	8	8	7	7	47	2
2	10	10	9	9	9	8	55	2
3	10	10	10	9	9	8	56	2
4								
								<b>6</b>

	Arrows						Tot.	Set Points
1	8	7	7	7	7	4	40	0
2	10	9	9	9	7	6	50	0
3	10	10	10	9	8	6	53	0
4								
								<b>0</b>

### Quarterfinal Match

Wed 29 Jun 2022 Starting Time: 15:45

Match Number 44

Target: 26  
Country Code: **ALG**  
Country: **Algeria**

Target: 27  
Country Code: **TUR**  
Country: **Turkey**

	Arrows						Tot.
1	9	9	8	8	7	5	46
2	9	9	9	8	7	6	48
3	9	9	8	7	7	6	46
4							

Set Points
0
0
0
<b>0</b>

### Winner

Set Points	Arrows						Tot.	
2	1	10	9	9	9	7	6	50
2	2	X	10	9	9	8	8	54
2	3	10	10	9	8	8	6	51
	4							

<b>6</b>
----------



### Semifinal Match

Wed 29 Jun 2022 Starting Time: 16:45

Match Number 49

Target: 20  
Country Code: **ITA**  
Country: **Italy**

Target: 21  
Country Code: **FRA**  
Country: **France**

	Arrows						Tot.
1	9	9	9	8	8	7	50
2	X	9	9	8	8	7	51
3	10	9	9	8	8	7	51
4							

Set Points
0
0
0

**0**

### Winner

Set Points	Arrows						Tot.	
2	1	10	10	10	9	9	8	56
2	2	X	10	10	10	9	9	58
2	3	9	9	10	8	8	8	52
	4							

**6**



### Semifinal Match

Wed 29 Jun 2022 Starting Time: 16:45

Match Number 50

Target: 23  
Country Code: **ESP**  
Country: **Spain**

Target: 24  
Country Code: **TUR**  
Country: **Turkey**

#### Winner

	Arrows						Tot.	Set Points
1	9	9	9	9	8	7	51	0
2	10	10	10	9	8	8	55	2
3	X	10	10	10	9	9	58	2
4	X	10	10	9	9	8	56	2
								<b>6</b>

	Arrows						Tot.	Set Points
1	10	10	9	8	8	8	53	2
2	9	9	9	9	8	8	52	0
3	10	10	9	9	9	7	54	0
4	10	9	9	9	8	8	53	0
								<b>2</b>



## RESULTS SUMMARY

Rank	NOC	Name
1	TUR Turkey	ANAGOZ Yasemin BASARAN Ezgi COSKUN Gulnaz
2	ITA Italy	ANDREOLI Tatiana BOARI Lucilla REBAGLIATI Chiara
3	FRA France	FLORENT Anaëlle MAUNIER Lucie VILLARD Laurena
4	GRE Greece	GKORILA Anatoli Martha NASOULA Maria PSARRA Evangelia
5	ESP Spain	CANALES Elia FERNANDEZ INFANTE Leyre UNAMUNZAGA ALTUNA Irati
6	CYP Cyprus	HADJIEROTOCRITOU Christina KOUROUNA Mikaella PETROU Elena
7	SLO Slovenia	CAVIC Urska COREL Nina UMER Ana





## RESULT BRACKETS

R. Round Rank/Score	NOC	Name	1/4 Elimin. Round	Semifinals	Finals
1/ 1928	TUR	<b>Turkey</b> ANAGOZ Yasemin BASARAN Ezgi COSKUN Gulnaz		<b>Turkey</b> 5 (53,51,56)	
	-Bye-				<b>Turkey</b> 5 (50,51,55,54)
5/ 1865	FRA	<b>France</b> FLORENT Anaëlle MAUNIER Lucie VILLARD Laurena	5 (52,50,54,45-T.24)	France	
4/ 1873	ESP	<b>Spain</b> CANALES Elia FERNANDEZ INFANTE Leyre UNAMUNZAGA ALTUNA Irati	4 (50,51,53,54-T.24)	1 (53,50,50)	
3/ 1890	GRE	<b>Greece</b> GKORILA Anatoli Martha NASOULA Maria PSARRA Evangelia		Greece	
1847	SLO	<b>Slovenia</b> CAVIC Urska COREL Nina UMER Ana	DNS	0 (45,46,51)	
7/ 1781	CYP	<b>Cyprus</b> HADJIEROTOCRITOU Christina KOUROUNA Mikaelia PETROU Elena	0 (41,38,46)	<b>Italy</b> 6 (50,51,53)	
2/ 1900	ITA	<b>Italy</b> ANDREOLI Tatiana BOARI Lucilla REBAGLIATI Chiara	6 (45,51,49)		
				<b>France</b> 6 (48,54,54,51)	
				Greece 2 (51,52,53,48)	
					<b>GOLD</b> Turkey
					<b>SILVER</b> Italy
					<b>BRONZE</b> France

Final Rank	
1	TUR Turkey
2	ITA Italy
3	FRA France
4	GRE Greece
5	ESP Spain 4 (208)
6	CYP Cyprus 0 (125)
7	SLO Slovenia



## RESULTS

OFFICIAL After 216 Arrows

**World Record 70 metres Round:** 2053 CHANG Hye Jin/KANG Chae Young/LEE Eun Gyeong KOR Antalya (TUR) 2018-05-21

Rank	NOC	Name	Individual Total	Team Total
1	TUR - Turkey	ANAGOZ Yasemin BASARAN Ezgi COSKUN Gulnaz	649 641 638	1928
2	ITA - Italy	ANDREOLI Tatiana BOARI Lucilla REBAGLIATI Chiara	634 637 629	1900
3	GRE - Greece	GKORILA Anatoli Martha NASOULA Maria PSARRA Evangelia	644 630 616	1890
4	ESP - Spain	CANALES Elia FERNANDEZ INFANTE Leyre UNAMUNZAGA ALTUNA Irati	642 635 596	1873
5	FRA - France	FLORENT Anaëlle MAUNIER Lucie VILLARD Laurena	624 614 627	1865
6	SLO - Slovenia	CAVIC Urska COREL Nina UMER Ana	603 601 643	1847
7	CYP - Cyprus	HADJIEROTOCRITOU Christina KOUROUNA Mikaella PETROU Elena	594 583 604	1781



### Gold Medal Match

Fri 1 Jul 2022 Starting Time: 09:55

Match Number 128

Target: 1  
Country Code: **TUR**  
Country: **Turkey**

Target: 2  
Country Code: **ITA**  
Country: **Italy**

#### Winner

	Arrows						Tot.
1	9	8	5	9	9	10	50
2	7	9	9	9	8	9	51
3	10	8	9	10	9	9	55
4	8	8	9	9	10	10	54

Set Points
2
0
2
1

**5**

Set Points
0
2
0
1

**3**

	Arrows						Tot.
1	8	8	8	8	9	8	49
2	10	8	9	8	10	8	53
3	7	10	9	9	9	9	53
4	9	10	8	9	8	10	54

Line Judge: LAMANDÉ Khaled Sofiane

Target Judge: KOURA Ahmed



### Bronze Medal Match

Fri 1 Jul 2022 Starting Time: 09:30

Match Number 127

Target: 1  
Country Code: **FRA**  
Country: **France**

Target: 2  
Country Code: **GRE**  
Country: **Greece**

Winner

	Arrows						Tot.
1	10	7	6	7	9	9	48
2	10	9	7	9	9	10	54
3	10	8	10	9	9	8	54
4	9	7	7	10	9	9	51

Set Points
0
2
2
2

6

Set Points
2
0
0
0

2

	Arrows						Tot.
1	10	8	10	8	7	8	51
2	9	7	9	10	8	9	52
3	8	9	9	10	9	8	53
4	5	10	9	8	9	7	48

Line Judge: ZURBANO Irati

Target Judge: KOURA Ahmed



Oran (ALG)

Oran 2022 XIX Mediterranean Games



Recurve Women Team

28 Jun - 1 Jul 2022

Team Matches Scorecards



### Quarterfinal Match

Wed 29 Jun 2022 Starting Time: 16:15

Match Number 46

Target: 8  
Country Code: **FRA**  
Country: **France**

Target: 9  
Country Code: **ESP**  
Country: **Spain**

#### Winner

	Arrows						Tot.	Set Points
1	X	10	10	9	8	5	52	2
2		10	9	9	9	7	50	0
3	X	10	10	9	8	7	54	2
4	X	9	8	8	6	4	45	0
S.O.1	X	8	6				24	1
								<b>5</b>

Set Points		Arrows						Tot.
0	1	X	9	9	8	8	6	50
2	2	X	10	9	8	8	6	51
0	3	10	10	9	8	8	8	53
2	4	10	9	9	9	9	8	54
0	S.O.1	10	8	6				24
<b>4</b>								



**Quarterfinal Match**

Wed 29 Jun 2022 Starting Time: 16:15

Match Number 47

Target: 11  
Country Code: **GRE**  
Country: **Greece**

Target: 12  
Country Code: **SLO**  
Country: **Slovenia**

**Winner**

	Arrows					Tot.	Set Points
1							
2							
3							
4							

**0**

**DNS**

Set Points		Arrows					Tot.
	1						
	2						
	3						
	4						

**0**



### Quarterfinal Match

Wed 29 Jun 2022 Starting Time: 16:15

Match Number 48

Target: 14  
Country Code: **CYP**  
Country: **Cyprus**

Target: 15  
Country Code: **ITA**  
Country: **Italy**

	Arrows						Tot.
1	9	9	7	6	5	5	41
2	9	7	7	6	5	4	38
3	8	8	8	8	7	7	46
4							

Set Points
0
0
0

**0**

### Winner

Set Points	Arrows						Tot.	
2	1	9	9	7	7	7	6	45
2	2	9	9	9	9	8	7	51
2	3	9	9	9	8	8	6	49
	4							

**6**





### Semifinal Match

Wed 29 Jun 2022 Starting Time: 16:45

Match Number 51

Target: 8  
Country Code: **TUR**  
Country: **Turkey**

Target: 9  
Country Code: **FRA**  
Country: **France**

Winner

	Arrows						Tot.	Set Points
1	10	9	9	9	9	7	53	1
2	X	9	9	8	8	7	51	2
3	X	X	9	9	9	9	56	2
4								
								<b>5</b>

	Arrows						Tot.	Set Points
1	9	9	9	9	9	8	53	1
2	9	9	9	8	8	7	50	0
3	10	9	8	8	8	7	50	0
4								
								<b>1</b>



### Semifinal Match

Wed 29 Jun 2022 Starting Time: 16:45

Match Number 52

Target: 11  
Country Code: **GRE**  
Country: **Greece**

Target: 12  
Country Code: **ITA**  
Country: **Italy**

	Arrows						Tot.
1	9	8	8	7	7	6	45
2	10	9	9	7	6	5	46
3	10	9	8	8	8	8	51
4							

Set Points
0
0
0
<b>0</b>

### Winner

Set Points	Arrows						Tot.	
2	1	X	10	9	9	6	6	50
2	2	10	9	8	8	8	8	51
2	3	X	X	10	8	8	7	53
	4							

<b>6</b>
----------



RESULT BRACKETS

R. Round Rank/Score	NOC	Name	1/8 Elimin. Round	1/4 Elimin. Round	Semifinals	Finals
1/ 1969	ITA	<b>Italy</b> MUSOLESI Federico NESPOLI Mauro PAOLI Alessandro	-Bye-	<b>Italy</b> 6 (53,57,56)	<b>Italy</b> 0 (50,51,51)	<b>Final Rank</b> 1 FRA France 2 ESP Spain 3 TUR Turkey 4 ITA Italy 5 CYP Cyprus 0 (148) 6 POR Portugal 0 (143) 7 ALG Algeria 0 (140) 8 SLO Slovenia
9/ 1751	KOS	Kosovo ASLLANI Hazir DVORANI Edi GLLAREVA Valmir	0 (49,43,46)	Cyprus		
8/ 1766	CYP	<b>Cyprus</b> CHARALAMBOUS Charalambos LOIZOU Konstantinos PANAGI Constantinos	6 (52,50,48)	0 (52,50,46)		
5/ 1907	SLO	<b>Slovenia</b> HABJAN MALAVASIC Den PODKRAJŠEK Sergej RAVNIKAR Ziga	-Bye-	Slovenia DNS		
			-Bye-		<b>France</b> 6 (56,58,52)	
4/ 1920	FRA	<b>France</b> BARITEAUD Iban BERNARDI Nicolas FICHET Romain		<b>France</b>		
3/ 1938	ESP	<b>Spain</b> ACHA Pablo ALVARINO GARCIA Miguel CASTRO Daniel	-Bye-	<b>Spain</b> 6 (47,55,56)		
			-Bye-		<b>Spain</b> 6 (51,55,58,56)	
6/ 1835	POR	<b>Portugal</b> CARNEIRO Nuno GONCALVES Luis MATOS Tiago		Portugal 0 (40,50,53)		
7/ 1774	ALG	<b>Algeria</b> BAKRI Imadeddine HOCINE Abdelmajid RAHLAOUI Ayoub	-Bye-	Algeria 0 (46,48,46)		
			-Bye-		Turkey 2 (53,52,54,53)	
2/ 1952	TUR	<b>Turkey</b> AK Samet GAZOZ Mete YILDIRMIS Muhammed		<b>Turkey</b> 6 (50,54,51)		
					Italy 4 (57,49,58,53-T.26)	
					<b>Turkey</b> 5 (56,51,52,55-T.28)	
					<b>GOLD</b> France	
					<b>SILVER</b> Spain	
					<b>BRONZE</b> Turkey	



## RESULT BRACKETS

R. Round Rank/Score	NOC	Name	1/4 Elimin. Round	Semifinals	Finals
1/ 1928	TUR	<b>Turkey</b> ANAGOZ Yasemin BASARAN Ezgi COSKUN Gulnaz		<b>Turkey</b> 5 (53,51,56)	
	-Bye-				<b>Turkey</b> 5 (50,51,55,54)
5/ 1865	FRA	<b>France</b> FLORENT Anaëlle MAUNIER Lucie VILLARD Laurena	5 (52,50,54,45-T.24)	France	
4/ 1873	ESP	<b>Spain</b> CANALES Elia FERNANDEZ INFANTE Leyre UNAMUNZAGA ALTUNA Irati	4 (50,51,53,54-T.24)	1 (53,50,50)	
3/ 1890	GRE	<b>Greece</b> GKORILA Anatoli Martha NASOULA Maria PSARRA Evangelia		Greece	
1847	SLO	<b>Slovenia</b> CAVIC Urska COREL Nina UMER Ana	DNS	0 (45,46,51)	
7/ 1781	CYP	<b>Cyprus</b> HADJIEROTOCRITOU Christina KOUROUNA Mikaelia PETROU Elena	0 (41,38,46)	<b>Italy</b> 6 (50,51,53)	
2/ 1900	ITA	<b>Italy</b> ANDREOLI Tatiana BOARI Lucilla REBAGLIATI Chiara	6 (45,51,49)		
				<b>France</b> 6 (48,54,54,51)	
				Greece 2 (51,52,53,48)	
					<b>GOLD</b> Turkey
					<b>SILVER</b> Italy
					<b>BRONZE</b> France

Final Rank	
1	TUR Turkey
2	ITA Italy
3	FRA France
4	GRE Greece
5	ESP Spain 4 (208)
6	CYP Cyprus 0 (125)
7	SLO Slovenia



RESULT BRACKETS

R. Round Rank/Score	NOC	Name	1/8 Elimin. Round	1/4 Elimin. Round	Semifinals	Finals
1/ 1319	TUR	<b>Turkey</b> ANAGOZ Yasemin GAZOZ Mete	-Bye-	<b>Turkey</b> 6 (35,40,38)	<b>Turkey</b> 5 (36,37,36,32-T.19)	<b>Final Rank</b> 1 TUR Turkey 2 ITA Italy 3 ESP Spain 4 GRE Greece 5 FRA France 4 (139) 6 SLO Slovenia 4 (137) 7 CYP Cyprus 0 (102) 8 TUN Tunisia 0 (94)
9/ 1186	EGY	Egypt AZZAM Nada ABDELBAR Aly	0 (27,32,32)	Cyprus		
8/ 1221	CYP	<b>Cyprus</b> PETROU Elena CHARALAMBOUS Charalambos	6 (34,34,33)	0 (33,36,33)		<b>Turkey</b> 5 (34,34,38,36)
5/ 1276	FRA	<b>France</b> VILLARD Laurena FICHET Romain	6 (34,32,34,38)	France		
12/ 884	LBA	Libya BAAYOU Maran ABORGIBA Majdi	2 (17,38,28,20)	4 (37,37,33,32-T.17)	Spain 4 (36,37,34,36-T.17)	<b>GOLD</b> Turkey
4/ 1295	ESP	<b>Spain</b> CANALES Elia ALVARINO GARCIA Miguel	-Bye-	<b>Spain</b> 5 (36,35,35,35-T.17+)		
3/ 1300	SLO	<b>Slovenia</b> CAVIC Urska RAVNIKAR Ziga	-Bye-	Slovenia 4 (37,35,28,37-T.17)	Greece 0 (32,34,32)	<b>SILVER</b> Italy
11/ 1176	SRB	Serbia BRKIC Anja STEFANOVIĆ Mihajlo	2 (31,32,34,32)	<b>Greece</b> 5 (33,36,36,29-T.18)		
6/ 1255	GRE	<b>Greece</b> GKORILA Anatoli Martha KARAGEORGIU Alexandros	6 (35,33,30,33)		Italy 3 (35,34,34,33)	<b>BRONZE</b> Spain
7/ 1242	TUN	<b>Tunisia</b> ELWALID Rihab HAMMED Mohamed	6 (35,35,37,34)	Tunisia 0 (26,34,34)		
10/ 1181	ALG	Algeria BELLAL Yasmine HOCINE Abdelmajid	2 (33,36,32,26)	-Bye-	<b>Italy</b> 6 (37,36,34)	<b>Greece</b> 2 (37,36,21,31)
2/ 1304	ITA	<b>Italy</b> BOARI Lucilla NESPOLI Mauro	-Bye-	<b>Italy</b> 6 (35,38,35)	<b>Spain</b> 6 (33,39,35,37)	

### Eighth of Final Match

Thu 30 Jun 2022 Starting Time: 14:45

Match Number 114

Target: 8  
Country Code: **EGY**  
Country: **Egypt**

Target: 9  
Country Code: **CYP**  
Country: **Cyprus**

	Arrows				Tot.
1	9	8	8	2	27
2	X	8	7	7	32
3	9	9	8	6	32
4					

Set Points
0
0
0

**0**

### Winner

Set Points
2
2
2

**6**

	Arrows				Tot.
1	10	8	8	8	34
2	9	9	9	7	34
3	9	9	8	7	33
4					

### Eighth of Final Match

Thu 30 Jun 2022 Starting Time: 14:45

Match Number 115

Target: 11  
Country Code: **FRA**  
Country: **France**

Target: 12  
Country Code: **LBA**  
Country: **Libya**

#### Winner

	Arrows				Tot.
1	9	9	8	8	34
2	9	9	8	6	32
3	9	9	8	8	34
4	X	10	9	9	38

Set Points
2
0
2
2

**6**

Set Points
0
2
0
0

**2**

	Arrows				Tot.
1	7	5	3	2	17
2	10	10	10	8	38
3	10	7	6	5	28
4	7	6	4	3	20

### Eighth of Final Match

Thu 30 Jun 2022 Starting Time: 14:45

Match Number 118

Target: 20  
Country Code: **SRB**  
Country: **Serbia**

Target: 21  
Country Code: **GRE**  
Country: **Greece**

	Arrows					Tot.
1	9	9	8	5		31
2	9	8	8	7		32
3	X	9	9	6		34
4	10	8	7	7		32

Set Points
0
0
2
0
<b>2</b>

### Winner

	Arrows					Tot.
1	9	9	9	8		35
2	9	9	8	7		33
3	9	9	6	6		30
4	9	9	9	6		33

Set Points
2
2
0
2
<b>6</b>



### Eighth of Final Match

Thu 30 Jun 2022 Starting Time: 14:45

Match Number 119

Target: 23  
Country Code: **TUN**  
Country: **Tunisia**

Target: 24  
Country Code: **ALG**  
Country: **Algeria**

#### Winner

	Arrows					Tot.
1	9	9	9	8		35
2	10	9	9	7		35
3	X	9	9	9		37
4	10	9	9	6		34

Set Points
2
0
2
2

**6**

Set Points
0
2
0
0

**2**

	Arrows					Tot.
1	9	9	9	6		33
2	X	9	9	8		36
3	10	9	8	5		32
4	8	7	7	4		26



### Gold Medal Match

Fri 1 Jul 2022 Starting Time: 11:50

Match Number 132

Target: 1  
Country Code: **TUR**  
Country: **Turkey**

Target: 2  
Country Code: **ITA**  
Country: **Italy**

#### Winner

	Arrows					Tot.
1	9	9	8	8		34
2	9	9	7	9		34
3	9	10	10	9		38
4	7	10	9	10		36

Set Points
0
1
2
2

**5**

Set Points
2
1
0
0

**3**

	Arrows					Tot.
1	9	9	8	9		35
2	8	9	8	9		34
3	9	8	10	7		34
4	9	7	8	9		33

Line Judge: ZURBANO Irati  
Target Judge: LEONIDOU Eleni



### Bronze Medal Match

Fri 1 Jul 2022 Starting Time: 11:30

Match Number 131

Target: 1  
Country Code: **ESP**  
Country: **Spain**

Target: 2  
Country Code: **GRE**  
Country: **Greece**

#### Winner

	Arrows					Tot.
1	7	9	8	9		33
2	10	10	10	9		39
3	8	10	9	8		35
4	9	9	9	10		37

Set Points
0
2
2
2

**6**

Set Points
2
0
0
0

**2**

	Arrows					Tot.
1	10	10	9	8		37
2	10	8	9	9		36
3	6	8	7	M		21
4	9	7	8	7		31

Line Judge: LAMANDÉ Khaled Sofiane

Target Judge: LEONIDOU Eleni

### Quarterfinal Match

Thu 30 Jun 2022 Starting Time: 15:10

Match Number 121

Target: 11  
Country Code: **TUR**  
Country: **Turkey**

Target: 12  
Country Code: **CYP**  
Country: **Cyprus**

#### Winner

	Arrows				Tot.
1	10	9	9	7	35
2	10	10	10	10	40
3	10	10	10	8	38
4					

Set Points
2
2
2

**6**

Set Points
0
0
0

**0**

	Arrows				Tot.
1	X	10	8	5	33
2	10	9	9	8	36
3	9	9	8	7	33
4					

### Quarterfinal Match

Thu 30 Jun 2022 Starting Time: 15:10  
Match Number 122

Target: 14  
Country Code: **FRA**  
Country: **France**

Target: 15  
Country Code: **ESP**  
Country: **Spain**

	Arrows					Tot.	Set Points
1	X	10	9	8		37	2
2	X	9	9	9		37	2
3	X	X	8	5		33	0
4	8	8	8	8		32	0
S.O.1	9	8				17	0
							4

Winner						
Set Points	Arrows					Tot.
0	1	X	10	8	8	36
0	2	X	9	9	7	35
2	3	10	10	9	6	35
2	4	9	9	9	8	35
1	S.O.1	9	8			17+
5	Closest to the center					

**Quarterfinal Match**

Thu 30 Jun 2022 Starting Time: 15:10  
Match Number 123

Target: 17  
Country Code: **SLO**  
Country: **Slovenia**

Target: 18  
Country Code: **GRE**  
Country: **Greece**

	Arrows					Tot.	Set Points
1	X	10	9	8		37	2
2	10	9	8	8		35	0
3	9	7	7	5		28	0
4	10	9	9	9		37	2
S.O.1	9	8				17	0
							4

Winner						
Set Points	Arrows					Tot.
0	1	9	8	8	8	33
2	2	9	9	9	9	36
2	3	X	10	8	8	36
0	4	8	8	7	6	29
1	S.O.1	9	9			18
5						



### Quarterfinal Match

Thu 30 Jun 2022 Starting Time: 15:10  
Match Number 124

Target: 20  
Country Code: **TUN**  
Country: **Tunisia**

Target: 21  
Country Code: **ITA**  
Country: **Italy**

	Arrows				Tot.
1	9	7	6	4	26
2	10	8	8	8	34
3	X	X	7	7	34
4					

Set Points
0
0
0

**0**

### Winner

Set Points
2
2
2

**6**

	Arrows				Tot.
1	9	9	9	8	35
2	X	10	9	9	38
3	9	9	9	8	35
4					



### Semifinal Match

Thu 30 Jun 2022 Starting Time: 15:35

Match Number 125

Target: 14  
Country Code: **TUR**  
Country: **Turkey**

Target: 15  
Country Code: **ESP**  
Country: **Spain**

#### Winner

	Arrows					Tot.	Set Points
1	10	9	9	8		36	1
2	10	10	9	8		37	1
3	10	10	9	7		36	2
4	9	8	8	7		32	0
S.O.1	10	9				19	1
							<b>5</b>

	Arrows					Tot.	Set Points
1	X	9	9	8		36	1
2	10	9	9	9		37	1
3	10	10	9	5		34	0
4	9	9	9	9		36	2
S.O.1	X	7				17	0
							<b>4</b>





### Semifinal Match

Thu 30 Jun 2022 Starting Time: 15:35  
Match Number 126

Target: 17  
Country Code: **GRE**  
Country: **Greece**

Target: 18  
Country Code: **ITA**  
Country: **Italy**

	Arrows				Tot.
1	9	9	7	7	32
2	10	9	8	7	34
3	9	8	8	7	32
4					

Set Points
0
0
0

**0**

### Winner

Set Points
2
2
2

**6**

	Arrows				Tot.
1	X	10	9	8	37
2	X	10	8	8	36
3	9	9	8	8	34
4					



ألعاب البحر الأبيض المتوسط  
MEDITERRANEAN GAMES  
JEUX MÉDITERRANÉENS  
du 25 juin au 06 juillet

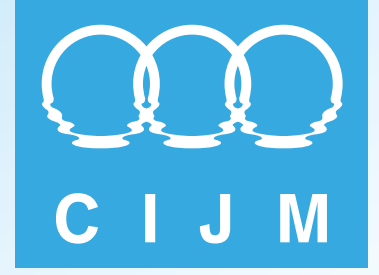

# Results Book



## Athletics



**TOSYALI  
ALGERIE**

Fer et Acier

سوناطراي



sonarach



microplus  
DATA PROCESSING & TIMING  
[www.microplustiming.com](http://www.microplustiming.com)

**Medallists by Event**
**REVISED  
SUN 3 JUL 22:18**
**As of SUN 3 JUL 2022 at 22:18**
**After 38 of 38 events**

Event Name	Date	Medal	Name	CTRY Code
Women 100m	THU 30 JUN 2022	GOLD	HEMIDA Basant	EGY
		SILVER	BAZOLO Lorene Dorcas	POR
		BRONZE	FOTOPOULOU Olivia	CYP
Women 100m Hurdles	SUN 3 JUL 2022	GOLD	COMPPEP Solenn	FRA
		SILVER	MOSETTI Nicla	ITA
		BRONZE	PESIRIDOU Elisavet	GRE
Women 1500m	SUN 3 JUL 2022	GOLD	FLEURY Aurore	FRA
		SILVER	DEL BUONO Federica	ITA
		BRONZE	CAVALLI Ludovica	ITA
Women 200m	SUN 3 JUL 2022	GOLD	HEMIDA Basant	EGY
		SILVER	FOTOPOULOU Olivia	CYP
		BRONZE	BAZOLO Lorene Dorcas	POR
Women 3000m Steeplechase	FRI 1 JUL 2022	GOLD	GEGA Luiza	ALB
		SILVER	BOUZAYANI Marwa	TUN
		BRONZE	OUAZIZ Ikram	MAR
Women 400m	SAT 2 JUL 2022	GOLD	DA SILVA AZEVEDO Catia Isabel	POR
		SILVER	HORVAT Anita	SLO
		BRONZE	TROIANI Virginia	ITA
Women 400m Hurdles	FRI 1 JUL 2022	GOLD	SARTORI Rebecca	ITA
		SILVER	SERI Camille	FRA
		BRONZE	ENNADI Noura	MAR
Women 5000m	SAT 2 JUL 2022	GOLD	CAN Yasemin	TUR
		SILVER	TAHIRI Rahma	MAR
		BRONZE	HADJI Leila	FRA
Women 800m	SAT 2 JUL 2022	GOLD	EKATERINE Gulivev	TUR
		SILVER	COIRO Eloisa	ITA
		BRONZE	RAZIKI Assia	MAR
Women Discus Throw	THU 30 JUN 2022	GOLD	TOLJ Marija	CRO
		SILVER	DA SILVA CA' Liliana	POR
		BRONZE	BECEREK Ozlem	TUR
Women Half Marathon	FRI 1 JUL 2022	GOLD	EPIS Giovanna	ITA
		SILVER	QALLOUJ Hanane	MAR
		BRONZE	EL MOUKIM Rkia	MAR
Women Hammer Throw	THU 30 JUN 2022	GOLD	REDONDO MORA Laura	ESP
		SILVER	SALMAN Kivilcim Kaya	TUR
		BRONZE	BOUZEBRA Zouina	ALG
Women High Jump	SUN 3 JUL 2022	GOLD	VUKOVIC Marija	MNE
		SILVER	GKOUSIN Tatiana	GRE
		BRONZE	MORARA Marta	ITA
Women Javelin Throw	SAT 2 JUL 2022	GOLD	VILAGOS Adriana	SRB
		SILVER	TUGSUZ Eda	TUR
		BRONZE	MINARD Alizee	FRA
Women Long Jump	FRI 1 JUL 2022	GOLD	GARDASEVIC Milica	SRB
		SILVER	OWIS Esraa	EGY
		BRONZE	TAVARES DA VEIGA Evelise Maria	POR



### Medallists by Event

REVISED  
SUN 3 JUL 22:18

As of SUN 3 JUL 2022 at 22:18

After 38 of 38 events

Event Name	Date	Medal	Name	CTRY Code
Women Triple Jump	SAT 2 JUL 2022	GOLD	FILIPIC Neja	SLO
		SILVER	DANISMAZ Tuqba	TUR
		BRONZE	EBOSELE EBOSELE Tessy	ESP
Men 100m	THU 30 JUN 2022	GOLD	HARVEY Jak Ali	TUR
		SILVER	GULIYEV Ramil	TUR
		BRONZE	NYFANTOPOULOS Ioannis	GRE
Men 110m Hurdles	SUN 3 JUL 2022	GOLD	TRAJKOVIC Milan	CYP
		SILVER	BOUANANI Amine	ALG
		BRONZE	LLOPIS DOMENECH Enrique	ESP
Men 1500m	SAT 2 JUL 2022	GOLD	HABZ Azeddine	FRA
		SILVER	SADIKI Abdellatif	MAR
		BRONZE	MESLEK Ossama	ITA
Men 200m	SUN 3 JUL 2022	GOLD	GULIYEV Ramil	TUR
		SILVER	PETTOROSSO Diego Aldo	ITA
		BRONZE	RODRIGUEZ SERRANO Daniel	ESP
Men 3000m Steeplechase	THU 30 JUN 2022	GOLD	TABTI Bilal	ALG
		SILVER	TINDOUFT Mohamed	MAR
		BRONZE	BOUCHICHA Hichem	ALG
Men 400m	SAT 2 JUL 2022	GOLD	AGOSTINHO COELHO Joao Ricardo	POR
		SILVER	DAIR Hamza	MAR
		BRONZE	BENDJEMAA Abdennour	ALG
Men 400m Hurdles	FRI 1 JUL 2022	GOLD	ESCOBAR Yasmani Copello	TUR
		SILVER	VAILLANT Ludvy	FRA
		BRONZE	LAHOULOU Abdelmalik	ALG
Men 5000m	SUN 3 JUL 2022	GOLD	BOUQANTAR Soufivan	MAR
		SILVER	FARES Mohamed	MAR
		BRONZE	QUAZZOLA Italo	ITA
Men 800m	SUN 3 JUL 2022	GOLD	SEDJATI Djamel	ALG
		SILVER	HETHAT Yassine	ALG
		BRONZE	TECUCEANU Catalin	ITA
Men Discus Throw	SUN 3 JUL 2022	GOLD	PARELLIS Apostolos	CYP
		SILVER	MARKOVIC Martin	CRO
		BRONZE	FURTULA Danijel	MNE
Men Half Marathon	FRI 1 JUL 2022	GOLD	OUTALHA Mohcin	MAR
		SILVER	CHOQUERT Benjamin	FRA
		BRONZE	BOUQANTAR Soufivan	MAR
Men Hammer Throw	FRI 1 JUL 2022	GOLD	BALTACI Ozkan	TUR
		SILVER	POURSANIDIS Alexandros	CYP
		BRONZE	OLIVIERI Giorgio	ITA
Men High Jump	FRI 1 JUL 2022	GOLD	AFER Bilel	ALG
		SILVER	GHAZAL Maid Eddin	SYR
		BRONZE	BOUHANOUNE Hichem	ALG
Men Javelin Throw	SAT 2 JUL 2022	GOLD	RAMOS Leandro Parrecas	POR
		SILVER	ABDELRAHMAN Ihab	EGY
		BRONZE	VAHAI SOSAIA Felise	FRA



### Medallists by Event

REVISED  
SUN 3 JUL 22:18

As of SUN 3 JUL 2022 at 22:18

After 38 of 38 events

Event Name	Date	Medal	Name	CTRY Code
Men Long Jump	SUN 3 JUL 2022	GOLD	BEY Loucif	FRA
		SILVER	ANIC Lazar	SRB
		BRONZE	TRIKI Yasser Mohammed	ALG
Men Pole Vault	SAT 2 JUL 2022	GOLD	SASMA Ersu	TUR
		SILVER	AMMIRATI Anthony	FRA
		BRONZE	RIZOS Ioannis	GRE
Men Shot Put	THU 30 JUN 2022	GOLD	SINANCEVIC Armin	SRB
		SILVER	KOLASINAC Asmir	SRB
		BRONZE	KHALIFA Mohamed	EGY
Men Triple Jump	THU 30 JUN 2022	GOLD	TRIKI Yasser Mohammed	ALG
		SILVER	BOCCHI Tobia	ITA
		BRONZE	LUIS PEREIRA Tiago Joao	POR
Women 4 x 100m Relay	FRI 1 JUL 2022	GOLD	BERTON Aurora	ITA
			HERRERA ABREU Johanelis	ITA
			HOOPER Gloria	ITA
			SIRAGUSA Irene	ITA
		SILVER	ATATOU Wided	FRA
			DE LA TAILLE Eloïse JOSEPH Gemima LECONTE Mallory	FRA FRA FRA
BRONZE	FOTOPOULOU Filippa	CYP		
	FOTOPOULOU Olivia	CYP		
	GEORGIOU Dafni	CYP		
	PISIARA Marianna	CYP		
Women 4 x 400m Relay	SUN 3 JUL 2022	GOLD	LUKUDO Raphaëla Boaheng	ITA
			POLINARI Anna	ITA
			TREVISAN Giancarla Dimich	ITA
			TROIANI Virginia	ITA
		SILVER	HORVAT Anita	SLO
			POGOREVC Maïa	SLO
			SMONKAR Jerneja	SLO
			ZUPIN Agata	SLO
		BRONZE	AYAZ Sevväl	TUR
EKATERINE Guliyev	TUR			
TOPTAS Tuqba	TUR			
YILDIRIM Busra	TUR			



## Medallists by Event

REVISED  
SUN 3 JUL 22:18

As of SUN 3 JUL 2022 at 22:18

After 38 of 38 events

Event Name	Date	Medal	Name	CTRY Code
Men 4 x 100m Relay	FRI 1 JUL 2022	GOLD	FEDERICI Andrea MELLUZZO Matteo PETTOROSSO Diego Aldo RIGALI Roberto	ITA ITA ITA ITA
		SILVER	BALTACI Ozkan GULIYEV Ramil HARVEY Jak Ali OZER Kayhan	TUR TUR TUR TUR
		BRONZE	AMMOUR Yanis LECONTE Jerry LEROUX Jeremy VERMONT Dylan	FRA FRA FRA FRA
Men 4 x 400m Relay	SUN 3 JUL 2022	GOLD	BENDJEMAA Abdennour GOUANED Mohamed Ali LAHOULOU Abdelmalik MOULA Slimane	ALG ALG ALG ALG
		SILVER	BIANCIARDI Lapo LEONARDI Giuseppe PIVOTTO Pietro RAIMONDI Matteo	ITA ITA ITA ITA
		BRONZE	ESCOBAR Yasmani Copello KAYA Oguzhan NEZIR Ismail OREN Sinan	TUR TUR TUR TUR



## Medal Standings

REVISED  
SUN 3 JUL 22:17

As of SUN 3 JUL 2022 at 22:17

After 38 of 38 events

Rank	Country	Men				Women				Total				Rank by total
		G	S	B	Tot	G	S	B	Tot	G	S	B	Tot	
1	TUR - Turkiye	5	2	1	8	2	3	2	7	7	5	3	15	2
2	ITA - Italy	1	3	4	8	4	3	3	10	5	6	7	18	1
3	ALG - Algeria	5	2	5	12			1	1	5	2	6	13	= 3
4	FRA - France	2	3	2	7	2	2	2	6	4	5	4	13	= 3
5	POR - Portugal	2		1	3	1	2	2	5	3	2	3	8	6
6	SRB - Serbia	1	2		3	2			2	3	2		5	= 8
7	MAR - Morocco	2	4	1	7		2	4	6	2	6	5	13	= 3
8	CYP - Cyprus	2	1		3		1	2	3	2	2	2	6	7
9	EGY - Egypt		1	1	2	2	1		3	2	2	1	5	= 8
10	SLO - Slovenia					1	2		3	1	2		3	12
11	CRO - Croatia		1		1	1			1	1	1		2	= 13
12	ESP - Spain			2	2	1		1	2	1		3	4	= 10
13	MNE - Montenegro			1	1	1			1	1		1	2	= 13
14	ALB - Albania					1			1	1			1	= 15
15	GRE - Greece			2	2		1	1	2		1	3	4	= 10
16	SYR - Syrian Arab Republic		1		1						1		1	= 15
16	TUN - Tunisia						1		1		1		1	= 15
<b>Total:</b>		<b>20</b>	<b>20</b>	<b>20</b>	<b>60</b>	<b>18</b>	<b>18</b>	<b>18</b>	<b>54</b>	<b>38</b>	<b>38</b>	<b>38</b>	<b>114</b>	

### LEGEND

- -  
- -



Complexe Olympique - Grand Stade  
Athletic



**ENTRY LIST BY NOC**

<i>NOC</i>	<i>BIB</i>	<i>SURNAME &amp; NAME</i>	<i>DATE OF BIRTH</i>	<i>HEIGHT</i>	<i>WEIGHT</i>	<i>EVENT</i>	<i>S.BEST</i>	<i>P.BEST</i>
<b>ALB</b>		<b>ALBANIA</b>						
	1	<b>GEGA Luiza</b>	05 NOV 1988	1.60	55	Women's 3000 m Steeplechas	<b>9:15.48</b>	<b>9:15.48</b>
	2	<b>BURRAJ Franko</b>	19 AUG 1998	1.93	82	Men's 400 m	<b>46.48</b>	<b>46.48</b>
		<b>Total Athletes: 2</b>						





ENTRY LIST BY NOC

NOC	BIB	SURNAME & NAME	DATE OF BIRTH	HEIGHT	WEIGHT	EVENT	S.BEST	P.BEST
<b>ALG ALGERIA</b>								
	5	AIT SALEM Souad	06 JAN 1979	1.80	70	Women's 5000 m		
	5	AIT SALEM Souad	06 JAN 1979	1.80	70	Women's Half Marathon		1:09:15
	7	BELABIOD Tahani Roumaiss	28 FEB 1991	1.70	60	Women's Long Jump	6.07	6.56
	8	BEN HADJA Afaf	10 FEB 1999	1.70	60	Women's High Jump		
	9	BENDERBAL Malika	03 JUL 1983	1.80	70	Women's Half Marathon		1:15:49
	10	BENHADJA Loubna	11 FEB 2001	1.70	60	Women's 400 m Hurdles	58.51	57.19
	11	BETTICHE Amina	14 DEC 1987	1.70	60	Women's 1500 m	4:18.62	4:14.91
	11	BETTICHE Amina	14 DEC 1987	1.70	60	Women's 3000 m Steeplechas	9:41.19	9:25.90
	12	BOULEHSA Meriem	03 OCT 1992	1.70	60	Women's 400 m	56.07	55.62
	13	BOUNAB Nabila	07 FEB 1994	1.70	60	Women's Discus Throw	47.24	47.24
	14	BOUZEBRA Zouina	03 OCT 1990	1.70	60	Women's Hammer Throw	63.48	65.20
	17	HAMEL Rahil	21 JUL 2002	1.70	60	Women's 100 m Hurdles	13.93	13.93
	18	HARKAS Wissal	21 JUL 2005	1.70	60	Women's Triple Jump		
	19	MOUICI Roukia	01 JAN 2003	1.70	60	Women's 800 m		
	21	REFFAS Abir	03 DEC 1997	1.75	75	Women's 1500 m		
	22	REZIK Darina Hadil	27 JUN 2003	1.80	70	Women's High Jump		
	23	REZZIK Ghania	21 DEC 2002	1.70	60	Women's 800 m	2:11.29	2:08.60
	24	SELMi Kaoutar	17 JAN 1996	1.75	75	Women's Long Jump	5.93	5.93
	24	SELMi Kaoutar	17 JAN 1996	1.75	75	Women's Triple Jump	12.60	13.10
	4	TATAR Zahra	30 NOV 1992			Women's Hammer Throw	62.11	62.11
	25	TOUATI Amina	27 FEB 2001	1.75	75	Women's 100 m		
	26	YAHl Nawal	09 SEP 1991	1.70	60	Women's 5000 m	15:54.39	15:54.39
	26	YAHl Nawal	09 SEP 1991	1.70	60	Women's Half Marathon	1:11:41	1:11:41
	27	ZINE Djamil	17 MAR 1997	1.80	70	Women's 200 m		
		<b>ALGERIA</b>				Women's 4 x 400 Relay		
	10	BENHADJA Loubna	11 FEB 2001	1.70	60			
	12	BOULEHSA Meriem	03 OCT 1992	1.70	60			
	15	FERDI Douaa	10 NOV 2000	1.75	75			
	16	GUEDAL Lina Maria	15 APR 2005	1.70	60			
	20	OUANIS Chaima	19 MAR 1998					
	28	ABINA Rida	07 FEB 1996	1.75	75	Men's Triple Jump		
	29	ABOUD Rabah	01 JAN 1981	1.80	75	Men's Half Marathon		1:04:01
	30	AFER Bilel	11 FEB 2001	1.80	75	Men's High Jump	2.16	2.16
	31	ATHMANI Skander Djamil	21 JUN 1992	1.80	75	Men's 100 m		10.29
	31	ATHMANI Skander Djamil	21 JUN 1992	1.80	75	Men's 200 m	21.01	20.77
	32	BENDJEMAA Abdennour	22 MAY 1994	1.75	75	Men's 400 m	47.33	47.33
	33	BOUANANI Amine	17 OCT 1997	1.75	75	Men's 110 m Hurdles	13.45	13.45
	34	BOUCHICHA Hichem	19 MAY 1989	1.80	75	Men's 3000 m Steeplechase	8:21.06	8:15.88
	35	BOUHANOUNE Hichem	01 JAN 1997	1.85	75	Men's High Jump	2.18	2.18
	36	BOUKMOUCHE Saber	20 APR 1992	1.75	75	Men's 400 m Hurdles	49.86	49.43
	37	BOURAKBA Abdelmoumene	19 MAR 1988	1.80	75	Men's Discus Throw	57.16	58.44
	38	BOUZIANE Mohamed Reda	09 OCT 1994	1.75	75	Men's Shot Put		
	39	CHERABI Hichem Khalil	30 MAR 1991	1.80	75	Men's Pole Vault	5.32	5.50
	40	DRABLI Mohamed-amine	21 APR 2000	1.75	70	Men's 1500 m		
	41	EL HANNACHI Nabil	17 JAN 1996	1.80	75	Men's Half Marathon		1:06:45
	43	GRINE Ali	21 JAN 1990	1.80	75	Men's 5000 m		
	44	HAMMOUNI Anas Es Saddik	10 NOV 1995	1.80	75	Men's 400 m		
	45	HETHAT Yassine	30 AUG 1991	1.80	75	Men's 800 m	1:44.06	1:44.06
	46	HOCINE Tarek	09 NOV 1996	1.75	75	Men's Long Jump		
	47	KEDDAR Salim	23 NOV 1993	1.75	73	Men's 1500 m	3:39.23	3:35.92
	48	KHENNOUSSI Oussama	28 DEC 1999	1.82	75	Men's Discus Throw	56.52	56.52
	49	LAAMEUCH EI Hadi	05 MAR 1990	1.75	70	Men's Half Marathon		1:04:22
	50	LAHOULOU Abdelmalik	07 MAY 1992	1.75	75	Men's 400 m Hurdles	49.53	48.39
	52	MERBOUHI Mohammed	02 JUL 1991	1.75	70	Men's 5000 m	13:40.10	13:40.10
	54	REDJECHTA Mohamed Raid Z	13 AUG 2002	1.75	75	Men's Shot Put		
	55	SAHEL Youcef	17 NOV 1993	1.75	75	Men's 100 m	10.46	10.46
	55	SAHEL Youcef	17 NOV 1993	1.75	75	Men's 200 m	20.77	20.77
	56	SEDJATI Djamel	03 MAY 1999	1.78	70	Men's 800 m		
	58	TABTI Bilal	07 JUN 1993	1.80	75	Men's 3000 m Steeplechase	8:20.71	8:20.20
	59	TRIKI Yasser Mohammed T	24 MAR 1997	1.80	75	Men's Long Jump	7.50	8.08
	59	TRIKI Yasser Mohammed T	24 MAR 1997	1.80	75	Men's Triple Jump	16.34	17.43
		<b>ALGERIA</b>				Men's 4 x 400 Relay		



### ENTRY LIST BY NOC

<i>NOC</i>	<i>BIB</i>	<i>SURNAME &amp; NAME</i>	<i>DATE OF BIRTH</i>	<i>HEIGHT</i>	<i>WEIGHT</i>	<i>EVENT</i>	<i>S.BEST</i>	<i>P.BEST</i>
	32	BENDJEMAA Abdennour	22 MAY 1994	1.75	75			
	42	GOUANED Mohamed Ali	05 JUL 2002	1.82	75			
	44	HAMMOUNI Anas Es Saddik	10 NOV 1995	1.80	75			
	50	LAHOULOU Abdelmalik	07 MAY 1992	1.75	75			
	51	LAREDJ Miloud	07 NOV 1986	1.82	75			
	53	MOULA Slimane	25 FEB 1999	1.80	75			
	57	SIKIOU Mouatez Abderraze	17 JUL 2001	1.75	75			
<b>Total Athletes: 55</b>								



### ENTRY LIST BY NOC

NOC	BIB	SURNAME & NAME	DATE OF BIRTH	HEIGHT	WEIGHT	EVENT	S.BEST	P.BEST
<b>AND ANDORRA</b>								
	62	LUQUE MAESTRE Bruna	28 DEC 2002	1.66	59	Women's 400 m Hurdles		
	63	MALAGA MORAN Carlota Mer	16 JAN 2002	1.60	54	Women's 200 m		25.73
	64	CARABAÑA VALENZUELA Nahu	10 NOV 1999	1.70	66	Men's 1500 m		3:48.74
	65	MOYA BETRIU Pol	09 DEC 1996	1.76	65	Men's 800 m	1:46.26	1:46.26
	65	MOYA BETRIU Pol	09 DEC 1996	1.76	65	Men's 1500 m	3:42.59	3.42
<b>Total Athletes: 4</b>								



## ENTRY LIST BY NOC

NOC	BIB	SURNAME & NAME	DATE OF BIRTH	HEIGHT	WEIGHT	EVENT	S.BEST	P.BEST
<b>BIH</b>	<b>BOSNIA AND HERZEGOVINA</b>							
	67	CUKOVIC Stefan	20 DEC 1997	1.83	72	Men's 1500 m	3:47.16	3:47.16
	68	MALKOCEVIC Rusmir	09 JAN 1996	1.90	82	Men's 400 m Hurdles	54.89	51.21
	69	MILEUSNIC Dejan	16 NOV 1991	1.88	105	Men's Javelin Throw	74.52	81.63
	70	MUJEZINOVIC Abedin	02 JUN 1993	1.83	77	Men's 800 m	1:46.74	1:45.87
	71	PEZER Mesud	27 AUG 1994	1.96	135	Men's Shot Put	20.51	21.48
	72	VEJZOVIC Hajrudin	01 DEC 2000	1.80	74	Men's 100 m	10.60	10.56
	73	VIKALO Edhem	21 JAN 2002	1.87	82	Men's 100 m	10.75	10.68
		<b>Total Athletes: 7</b>						



## ENTRY LIST BY NOC

NOC	BIB	SURNAME & NAME	DATE OF BIRTH	HEIGHT	WEIGHT	EVENT	S.BEST	P.BEST
<b>CRO CROATIA</b>								
	75	LONCAREK Ivana	08 APR 1991	1.64	56	Women's 100 m Hurdles	13.45	13.09
	76	TOLJ Marija	29 NOV 1999	1.89	112	Women's Discus Throw	61.77	63.39
	77	CUKMAN Hrvoje	28 MAY 1998	1.91	88	Men's 110 m Hurdles	14.41	14.41
	78	MARKOVIC Martin	13 JAN 1996	1.87	117	Men's Discus Throw	63.22	63.62
	79	RUZIC Mateo	16 AUG 1994	1.88	85	Men's 400 m	47.91	46.13
	80	VIDEKA Karlo	25 APR 2000	1.70	63	Men's 800 m	1:50.84	1:50.84
	81	VUKOVIC Jakov	13 FEB 2001	1.83	70	Men's 400 m	46.64	46.64
<b>Total Athletes: 7</b>								



## ENTRY LIST BY NOC

NOC	BIB	SURNAME & NAME	DATE OF BIRTH	HEIGHT	WEIGHT	EVENT	S.BEST	P.BEST
<b>CYP CYPRUS</b>								
	83	CHARALAMBOUS Despoina	22 MAY 2000	1.69	51	Women's High Jump	1.81	1.84
	82	CHARALAMBOUS Thalia	26 AUG 1989	1.68	57	Women's 1500 m		
	82	CHARALAMBOUS Thalia	26 AUG 1989	1.68	57	Women's 5000 m	16:17.13	16:17.13
	82	CHARALAMBOUS Thalia	26 AUG 1989	1.68	57	Women's Half Marathon		1:14:40
	84	CHRISTOFI Natalia	10 FEB 1997	1.74	67	Women's 100 m Hurdles	13.34	13.17
	85	EVANGELIDOU Natalia	10 MAR 1991	1.68	55	Women's 1500 m	4:22.52	4:10.98
	87	FOTOPOULOU Filippa	20 DEC 1996	1.63	49	Women's Long Jump	6.79	6.79
	86	FOTOPOULOU Olivia	20 DEC 1996	1.63	49	Women's 100 m	11.37	11.37
	86	FOTOPOULOU Olivia	20 DEC 1996	1.63	49	Women's 200 m	23.51	23.31
	88	GEORGIOU Dafni	18 AUG 1999	1.72	58	Women's 100 m Hurdles	13.40	13.40
	89	IOANNIDOU Styliana	17 DEC 2003	1.73	54	Women's High Jump	1.80	1.87
	90	KYRIAKOU Chrystalla	04 OCT 1996	1.64	75	Women's Hammer Throw	63.61	63.61
	91	LADA Androniki	19 APR 1991	1.81	96	Women's Discus Throw	56.80	59.18
	92	PISIARA Marianna	10 MAY 1997	1.71	68	Women's 100 m	11.73	11.73
	92	PISIARA Marianna	10 MAY 1997	1.71	68	Women's 200 m	24.55	24.55
		<b>CYPRUS</b>				Women's 4 x 100 Relay		
	84	CHRISTOFI Natalia	10 FEB 1997	1.74	67			
	86	FOTOPOULOU Olivia	20 DEC 1996	1.63	49			
	87	FOTOPOULOU Filippa	20 DEC 1996	1.63	49			
	88	GEORGIOU Dafni	18 AUG 1999	1.72	58			
	92	PISIARA Marianna	10 MAY 1997	1.71	68			
	93	AVGOUSTINOUS Stavros	11 AUG 1998	1.80	82	Men's 200 m	21.26	21.26
	95	BEECHY Alexander	08 JUN 1991	1.79	75	Men's 100 m	10.79	10.59
	95	BEECHY Alexander	08 JUN 1991	1.79	75	Men's 200 m		
	97	DIMITRIOU Christos	22 SEP 1993	1.80	74	Men's 800 m	1:50.82	1:47.19
	98	GENETHLI Christoforos	19 FEB 1998	1.90	117	Men's Discus Throw	62.19	62.19
	99	KHADIRI Amine	20 NOV 1988	1.70	60	Men's Half Marathon	1:05:37	1:05:37
	100	KONSTANTINOU Vasilios	13 SEP 1992	1.80	66	Men's High Jump	2.20	2.28
	101	PAMPAKAS Kyriakos	14 JUL 2001	1.87	76	Men's High Jump	2.12	2.12
	102	PARELLIS Apostolos	24 JUL 1985	1.86	113	Men's Discus Throw	65.54	66.32
	103	POURSANIDIS Alexandros	23 JAN 1993	1.88	122	Men's Hammer Throw	70.70	74.05
	104	SAVVA Spyros	24 JAN 2000	1.79	82	Men's Javelin Throw	73.20	73.20
	106	STYLIANOU Nikandros	22 AUG 1989	1.80	75	Men's Pole Vault	5.15	5.55
	107	TAMANIS Christos	22 DEC 2000	1.76	73	Men's Pole Vault	5.20	5.20
	108	TRAJKOVIC Milan	17 MAR 1992	1.87	82	Men's 110 m Hurdles	13.38	13.25

Total Athletes: 24



## ENTRY LIST BY NOC

NOC	BIB	SURNAME & NAME	DATE OF BIRTH	HEIGHT	WEIGHT	EVENT	S.BEST	P.BEST
<b>EGY</b>	<b>EGYPT</b>							
	109	AHMED Lina	11 MAR 1997	1.65	65	Women's 100 m Hurdles	13.91	13.64
	110	BARAKAT Rawan	17 JUL 2001	1.78	75	Women's Hammer Throw	66.73	67.14
	111	HEMIDA Basant	28 SEP 1996	1.66	62	Women's 100 m	11.02	11.02
	111	HEMIDA Basant	28 SEP 1996	1.66	62	Women's 200 m	22.63	22.63
	112	OWIS Esraa	15 OCT 1997	1.70	67	Women's Long Jump	6.56	6.56
	113	ABDELRAHMAN Ihab	01 MAY 1989	1.94	110	Men's Javelin Throw	83.79	89.21
	114	ABOUTALEB Mohamed	21 FEB 1990	1.98	87	Men's High Jump	2.10	2.12
	115	AMER Maged	29 SEP 1995	1.81	84	Men's Javelin Throw		
	116	ELASHRY Alaaeldin	06 JAN 1991	1.86	115	Men's Hammer Throw	71.20	75.41
	117	ELGAMAL Mostafa	01 OCT 1988	1.92	121	Men's Hammer Throw	73.03	81.27
	119	KHALIFA Mohamed	30 AUG 1996	1.98	135	Men's Shot Put		
	120	RAMADAN Youssef	07 FEB 2002	1.83	77	Men's 110 m Hurdles		

Total Athletes: 11



## ENTRY LIST BY NOC

NOC	BIB	SURNAME & NAME	DATE OF BIRTH	HEIGHT	WEIGHT	EVENT	S.BEST	P.BEST
<b>ESP SPAIN</b>								
	121	EBOSELE EBOSELE Tessy	28 JUL 2002	1.73	80	Women's Triple Jump		13.63
	122	GARCIA ALONSO Marta	01 JAN 1998	1.65	53	Women's 1500 m	4:07.31	4:07.31
	122	GARCIA ALONSO Marta	01 JAN 1998	1.65	53	Women's 5000 m	15:28.55	15:28.55
	123	GARCIA SANCHEZ Carla	09 OCT 2001	1.73	60	Women's 400 m Hurdles	56.69	56.69
	124	GARCIA TENA Daniela	31 AUG 2001	1.63	48	Women's 800 m	2:03.02	2:03.02
	125	HERVAS RODRIGUEZ Blanca	30 SEP 2002	1.74	54	Women's 400 m	53.85	53.85
	126	MARCO MORA Carmen	17 DEC 1999	1.68	55	Women's 100 m	11.46	11.46
	127	MARTINEZ ORTUNO Marina	13 JAN 2002	1.74	55	Women's 1500 m	4:10.51	4:10.51
	128	MITXELENA BALERDI Irati	03 JUL 1998	1.71	54	Women's Long Jump	6.42	6.42
	129	ODEH ODEH Osarumen	15 NOV 1995	1.70	76	Women's Hammer Throw	66.81	66.81
	130	RADSMA AGUILAR Aitana	31 JAN 2002	1.78	69	Women's 100 m Hurdles	13.53	13.39
	131	REDONDO MORA Laura	03 JUL 1988	1.65	95	Women's Hammer Throw	72.00	72.00
	132	SANTIDRIAN RUIZ Eva	25 JAN 2000	1.70	62	Women's 200 m	23.75	23.68
	133	VINARAS OTEO Clara	08 SEP 1993	1.67	48	Women's 3000 m Steeplechas	9:44.24	9:44.24
	134	CANAL GARCIA Inaki	30 SEP 1997	1.81	70	Men's 400 m	46.04	46.04
	135	CASAS GARRIDO Diego	29 APR 1999	1.98	103	Men's Discus Throw	58.53	59.12
	136	CISNEROS ALBA Daniel	02 JUN 1996	1.90	76	Men's 110 m Hurdles	13.53	13.53
	137	EL KHAYAMI EL KOMIRY Abd	11 AUG 1995	1.84	67	Men's 1500 m	3:40.04	3:38.84
	138	GONZALEZ MOYANO Alberto	01 JUN 1998	1.95	120	Men's Hammer Throw	69.35	75.78
	139	GUERRA ALEJANDRE Jaime	30 OCT 1999	1.79	71	Men's Long Jump	8.08	8.08
	140	GUERRERO CASCON Alberto	04 APR 1995	1.74	64	Men's 800 m	1:45.84	1:45.84
	141	LEYVA DONAYRE Isidro	25 APR 1999	1.76	65	Men's Pole Vault	5.50	5.52
	142	LLOPIS DOMENECH Enrique	15 OCT 2000	1.91	77	Men's 110 m Hurdles	13.52	13.41
	143	LOPEZ BARRANCO Sergio	05 JUL 1999	1.80	77	Men's 100 m	10.28	10.27
	145	PORRAS CANTONS Aleix Sal	09 NOV 1999	1.82	65	Men's 400 m Hurdles	50.52	50.35
	146	QUIJADA SANCHEZ Alejandr	07 MAR 2001	1.85	68	Men's 3000 m Steeplechase	8:51.96	8:37.02
	147	RODRIGUEZ SERRANO Daniel	26 JAN 1995	1.78	70	Men's 200 m	20.97	20.59
<b>Total Athletes: 26</b>								





## ENTRY LIST BY NOC

NOC	BIB	SURNAME & NAME	DATE OF BIRTH	HEIGHT	WEIGHT	EVENT	S.BEST	P.BEST
<b>FRA</b>	<b>FRANCE</b>							
	148	ASSANI ISSOUF Jeanine	17 AUG 1992	1.71	60	Women's Triple Jump	13.94	14.43
	150	CLEYET-MERLE Berenice	24 OCT 1994	1.71	57	Women's 1500 m	4:16.49	4:08.70
	151	COMPPE Solenn	14 MAR 1995	1.65	59	Women's 100 m Hurdles	12.97	12.97
	152	FLEURY Aurore	04 DEC 1993	1.61	49	Women's 1500 m	4:04.78	4:03.35
	158	GICQUEL Solene	01 DEC 1994	1.89	69	Women's High Jump	1.88	1.90
	159	GREBO Shana	09 NOV 2000	1.69	60	Women's 400 m Hurdles	56.28	56.28
	160	HADJI Leila	01 JAN 1998	1.65	54	Women's 5000 m	15:48.36	15:48.36
	161	JOSEPH Gemima	17 OCT 2001	1.65	57	Women's 200 m	23.46	22.77
	162	JULIEN Melody	13 MAY 1999	1.68	49	Women's Half Marathon	1:11:07	1:11:07
	164	LEMITRE Alexa	10 APR 1998	1.63	53	Women's 3000 m Steeplechas	9:57.14	9:49.18
	165	MAUCHANT Tiphaine	05 APR 2001	1.73	58	Women's Long Jump	6.43	6.46
	166	MAXWELL-QUINOL Laureen	23 MAY 2002	1.80	64	Women's High Jump	1.80	1.91
	167	MINARD Alizee	06 MAY 1997	1.77	76	Women's Javelin Throw	57.62	57.91
	179	NGOMATEKE Xena	26 AUG 1998	1.74	85	Women's Hammer Throw		75.38
	168	OUREGA Marie-jeanne	04 APR 1997	1.69	58	Women's Long Jump	6.58	6.58
	170	PELTIER Fanny	25 MAY 1997	1.70	54	Women's 200 m		23.13
	171	PIZZO Charlotte	10 MAY 1997	1.74	58	Women's 800 m	2:03.78	2:00.86
	172	RENOUARD Flavie	10 SEP 2000	1.69	52	Women's 3000 m Steeplechas	9:36.59	9:36.59
	174	ROLLIN Meline	17 JUN 1998	1.69	50	Women's Half Marathon	1:11:22	1:11:22
	175	SAHNOUNE Meriem	05 JUN 1994	1.83	65	Women's 800 m	2:02.28	2:01.75
	176	SERI Camille	01 MAY 1999	1.54	49	Women's 400 m Hurdles	55.79	55.79
	177	SIERACKI Margaux	17 JUN 1999	1.60	47	Women's Half Marathon	1:11:01	1:11:01
	178	TAILLANDIER Lorelei	08 AUG 1991	1.69	73	Women's Hammer Throw	65.01	65.01
	149	VENDOME Lea	15 SEP 2002	1.74	73	Women's 100 m Hurdles		
		<b>FRANCE</b>				Women's 4 x 100 Relay		
	60	DE LA TAILLE Eloise	11 MAY 1999	1.60	58			
	157	ATATOU Wided	15 JUL 1999	1.70	58			
	161	JOSEPH Gemima	17 OCT 2001	1.65	57			
	163	LECONTE Mallory	04 OCT 2000	1.73	60			
	169	PARE Maroussia	18 JUL 1996	1.64	52			
	173	RICHARD Sarah	02 APR 1998	1.82	68			
	180	AIRIAU Gatien	09 JUN 1993	1.72	61	Men's 3000 m Steeplechase	8:27.26	8:27.26
	181	AMMIRATI Anthony	16 JUL 2003	1.80	75	Men's Pole Vault	5.65	5.72
	183	BEDARD Simon	03 JAN 1997	1.78	63	Men's 5000 m		13:34.83
	184	BEY Loucif	06 JUN 1995	1.80	67	Men's Long Jump	8.00	8.16
	185	BRUXELLE Jean-baptiste	09 JUL 2002	1.87	113	Men's Hammer Throw	75.20	75.20
	186	CAMPAGNE Tom	14 NOV 2000	1.79	71	Men's Long Jump	8.06	8.06
	187	CHAUSSINAND Yann	11 MAY 1998	1.96	105	Men's Hammer Throw	77.34	77.34
	188	CHOQUERT Benjamin	17 APR 1986	1.69	57	Men's Half Marathon		1:01:32
	189	COLLET Mathieu	15 MAR 1995	1.80	72	Men's Pole Vault	5.60	5.63
	190	CONROY Remi	17 JUN 1998	1.91	100	Men's Javelin Throw	74.64	76.32
	191	CULTRU Sacha	05 JAN 1999	1.82	70	Men's 800 m	1:47.01	1:46.04
	192	DAGEE Frederic	11 DEC 1992	1.92	122	Men's Shot Put	20.32	20.75
	193	DUIGOU Clement	26 APR 1996	1.78	61	Men's 3000 m Steeplechase	8:29.05	8:29.05
	194	FRERE Mehdi	27 JUL 1996	1.80	66	Men's 5000 m	13:40.37	13:38.10
	195	HABZ Azeddine	19 JUL 1993	1.86	70	Men's 1500 m	3:36.22	3:31.74
	196	HODEBAR Enzo	17 MAY 1999	1.86	79	Men's Triple Jump	16.67	16.99
	197	ISMAR Nathan	30 MAR 1999	2.00	90	Men's High Jump	2.26	2.26
	198	JORDIER Thomas	12 AUG 1994	1.70	75	Men's 400 m	46.72	45.49
	199	KOUNTA Muhammad	27 OCT 1994	1.84	75	Men's 400 m Hurdles	49.70	49.41
	200	KOWAL Yoann	28 MAY 1987	1.72	60	Men's Half Marathon	1:02:17	1:02:17
	201	KWAOU-MATHEY Just	04 DEC 1999	1.89	75	Men's 110 m Hurdles	13.27	13.27
	202	LE DEAN Geoffrey	20 JAN 1988	1.74	55	Men's Half Marathon	1:03:15	1:03:15
	203	LE MEUR Ludovic	24 JUN 1998	1.90	76	Men's 800 m	1:47.86	1:46.40
	207	MICHEAU S.bastien	03 MAY 1998	1.81	65	Men's High Jump	2.23	2.23
	208	MOHAMED Raphael	02 FEB 1998	1.83	64	Men's 110 m Hurdles	13.62	13.56
	209	MOUDANI-LIKIBI Fred	10 MAY 1999	1.94	124	Men's Shot Put	19.55	19.55
	210	NALIALI Christopher	08 MAR 1992	1.87	78	Men's 400 m	45.93	45.93
	240	RANC Julian	14 SEP 1996	1.80	60	Men's 1500 m	3:38.07	3:37.74
	241	REUX Tom	24 FEB 1999	1.88	108	Men's Discus Throw	60.86	60.86
	212	VAHAI-SOSAIA Felise	30 JUL 1999	1.90	94	Men's Javelin Throw		
	213	VAILLANT Ludvy	15 MAR 1995	1.81	73	Men's 400 m Hurdles	49.10	48.30
		<b>FRANCE</b>				Men's 4 x 100 Relay		



## ENTRY LIST BY NOC

NOC	BIB	SURNAME & NAME	DATE OF BIRTH	HEIGHT	WEIGHT	EVENT	S.BEST	P.BEST
	182	AMMOUR Yanis	04 NOV 1998	1.75	69			
	204	LECONTE Jerv	04 OCT 2000	1.82	75			
	205	LEROUX Jeremy	10 SEP 1994	1.83	79			
	206	MATEO Pablo	01 FEB 2001	1.83	63			
	211	PRIAM Avmeric	26 JUN 2000	1.80	79			
	214	VERMONT Dylan	24 AUG 1999	1.82	72			
		<b>FRANCE</b>				Men's 4 x 400 Relay		
	198	JORDIER Thomas	12 AUG 1994	1.70	75			
	199	KOUNTA Muhammad	27 OCT 1994	1.84	75			
	210	NALIALI Christopher	08 MAR 1992	1.87	78			
	213	VAILLANT Ludvy	15 MAR 1995	1.81	73			
		<b>Total Athletes: 66</b>						



## ENTRY LIST BY NOC

NOC	BIB	SURNAME & NAME	DATE OF BIRTH	HEIGHT	WEIGHT	EVENT	S.BEST	P.BEST
<b>GRE GREECE</b>								
	216	CHAITIDOU Vasiliki	10 FEB 2000	1.66	57	Women's Long Jump	6.49	6.49
	217	CHRISTOGEORGOU Eleftheri	19 AUG 1998	1.78	60	Women's High Jump	1.93	1.93
	218	GKOUSIN OR GUSIN Tatiana	26 JAN 1994	1.88	73	Women's High Jump	1.89	1.91
	219	GNAFAKI Dimitra	09 JUL 1997	1.71	56	Women's 400 m Hurdles	56.67	56.67
	220	MARINAKOU Anastasia Pana	12 JUN 1996	1.65	49	Women's 5000 m	15:50.23	15:50.23
	221	PESIRIDOU Elisavet	12 FEB 1992	1.75	60	Women's 100 m Hurdles	13.18	12.93
	222	ANAGNOSTOU Marios	08 OCT 1999	1.78	60	Men's 5000 m	14:18.47	14:06.94
	224	KARIOFYLLIS Ioannis	18 SEP 2002	1.70	66	Men's 200 m	21.25	21.17
	225	KOTITSAS Christos	06 OCT 1996	1.86	70	Men's 800 m	1:47.00	1:47.00
	226	LATIFLLARI Anastasios	08 AUG 1996	1.85	135	Men's Shot Put	19.93	19.93
	227	MERLOS Antonios	04 APR 1999	1.95	78	Men's High Jump	2.21	2.23
	228	MOUZENIDIS Odysseas	30 JUN 1999	1.82	122	Men's Shot Put	19.92	19.92
	229	NTOUSAKIS Orestis	02 MAY 2002	1.82	80	Men's Hammer Throw	70.36	70.36
	230	NYFANTOPOULOS Ioannis	01 NOV 1990	1.82	82	Men's 100 m	10.37	10.30
	232	RIZOS Ioannis	02 MAR 2000	1.80	78	Men's Pole Vault	5.50	5.50
	233	STAMOULIS Georgios	26 SEP 1998	1.79	64	Men's 3000 m Steeplechase	8:48.79	8:48.79
	234	TRIVYZAS Panagiotis	22 NOV 1987	1.90	80	Men's 200 m	20.72	20.58
	236	TSITSOS Dimitrios	27 SEP 2000	1.87	90	Men's Javelin Throw	77.51	78.22
	237	XENIDAKIS Charidimos	08 FEB 2000	1.84	67	Men's 800 m	1:48.63	1:48.63
	238	ZALTOS Konstantinos	05 FEB 2000	1.90	100	Men's Hammer Throw	72.51	72.51
	239	ZIKOS Konstantinos	24 APR 1998	1.74	76	Men's 100 m	10.46	10.41
		<b>GREECE</b>				Men's 4 x 100 Relay		
	224	KARIOFYLLIS Ioannis	18 SEP 2002	1.70	66			
	230	NYFANTOPOULOS Ioannis	01 NOV 1990	1.82	82			
	231	PANAGIOTOPOULOS Nikolaos	30 OCT 2002	1.80	69			
	234	TRIVYZAS Panagiotis	22 NOV 1987	1.90	80			
	239	ZIKOS Konstantinos	24 APR 1998	1.74	76			

**Total Athletes: 22**



ENTRY LIST BY NOC

NOC	BIB	SURNAME & NAME	DATE OF BIRTH	HEIGHT	WEIGHT	EVENT	S.BEST	P.BEST
<b>ITA</b>	<b>ITALY</b>							
	242	ARNAUDO Anna	18 OCT 2000			Women's 3000 m Steeplechas		9:45.86
	243	BELLINAZZI Giorgia	20 JUL 2000			Women's 100 m	11.54	11.54
	245	BRUNEY Maya Fonda	24 FEB 1998			Women's 200 m	23.50	23.04
	246	CARRARO Elena	03 JAN 2001			Women's 100 m Hurdles	13.13	13.13
	247	CAVALLI Ludovica	20 DEC 2000			Women's 1500 m	4:05.79	4:05.79
	249	COIRO Eloisa	01 DEC 2000			Women's 800 m		
	250	DEL BUONO Federica	12 DEC 1994			Women's 1500 m	4:03.45	4:03.45
	251	EPIS Giovanna	11 OCT 1988			Women's Half Marathon	1:11:07	1:11:01
	252	FORTUNA Diletta	03 MAR 2001			Women's Discus Throw	55.60	55.60
	253	FURLANI Erika	02 JAN 1996			Women's High Jump	1.91	1.94
	255	HOOPEER Gloria	03 MAR 1992			Women's 100 m	11.50	11.24
	256	LONEDO Rebecca	05 DEC 1996			Women's Half Marathon		1:11:08
	257	LUKUDO Raphaela Boaheng	29 JUL 1994	1.73	60	Women's 400 m	52.86	52.38
	258	MAFFO Nadia	06 JUN 1996			Women's Hammer Throw	66.56	66.56
	259	MATTAGLIANO Joyce	03 MAY 1994			Women's 800 m	2:02.60	2:02.60
	261	MERLO Martina	19 FEB 1993			Women's 3000 m Steeplechas		9:37.72
	262	MORARA Marta	26 DEC 1999	1.77	62	Women's High Jump	1.85	1.85
	263	MOSETTI Nicla	24 AUG 1997	1.75	65	Women's 100 m Hurdles	13.18	13.18
	264	MURARO Alice	14 AUG 2000			Women's 400 m Hurdles	57.44	57.37
	266	PRINETTI ANZALAPYA Lucia	03 NOV 1997	1.75	62	Women's Hammer Throw	65.10	65.10
	267	SARTORI Rebecca	22 MAY 1997			Women's 400 m Hurdles	55.40	55.40
	268	SELVA Giovanna	17 SEP 2000			Women's 5000 m		15:59.00
	269	SIRAGUSA Irene	23 JUN 1993			Women's 200 m	23.05	22.96
	270	STRATI Laura	03 OCT 1990			Women's Long Jump	6.21	6.72
	271	STRUMILLO Stefania	14 OCT 1989	1.74	65	Women's Discus Throw	58.86	59.80
	273	TROIANI Virginia	22 FEB 1996	1.75	62	Women's 400 m	52.10	52.10
	223	VISCA Carolina	31 MAY 2000			Women's Javelin Throw	56.75	58.47
	274	ZABARINO Sara	01 AUG 1999			Women's Javelin Throw	55.66	58.62
		<b>ITALY</b>				Women's 4 x 100 Relay		
	243	BELLINAZZI Giorgia	20 JUL 2000					
	244	BERTON Aurora	18 AUG 2000					
	254	HERRERA ABREU Johanelis	01 AUG 1995	1.85	81			
	255	HOOPEER Gloria	03 MAR 1992					
	260	MELON Chiara	08 OCT 1999					
	269	SIRAGUSA Irene	23 JUN 1993					
		<b>ITALY</b>				Women's 4 x 400 Relay		
	245	BRUNEY Maya Fonda	24 FEB 1998					
	257	LUKUDO Raphaela Boaheng	29 JUL 1994	1.73	60			
	265	POLINARI Anna	07 FEB 1999					
	272	TREVISAN Giancarla Dimic	17 FEB 1993					
	241	TROIANI Alexandra	22 FEB 1996	1.75	70			
	273	TROIANI Virginia	22 FEB 1996	1.75	62			
	276	ARESE Pietro	08 OCT 1999			Men's 1500 m	3:37.30	3:37.23
	277	BARONTINI Simone	05 JAN 1999			Men's 800 m	1:46.72	1:46.13
	278	BENCOSME DE LEON Jose' R	16 MAY 1992			Men's 400 m Hurdles	49.29	49.22
	279	BIANCHETTI Sebastiano	20 JAN 1996			Men's Shot Put	20.03	20.17
	280	BIANCIARDI Lapo	06 JUL 1998			Men's 400 m	46.60	46.60
	281	BOCCHI Tobia	07 APR 1997			Men's Triple Jump	16.73	17.14
	282	CHILA' Gabriele	17 SEP 1997			Men's Long Jump	7.81	7.81
	283	DALLAVALLE Andrea	31 OCT 1999			Men's Triple Jump	17.25	17.35
	284	DE ANGELIS Ivan	03 MAR 2001			Men's Pole Vault	5.45	5.50
	285	DE CARO Dario	01 JUN 1997			Men's 5000 m	13:45.56	13:45.56
	286	DI MARCO Nazzareno	30 APR 1985			Men's Discus Throw	60.88	64.93
	287	FALOCCHI Christian	30 JAN 1997			Men's High Jump	2.23	2.24
	288	FALOCI Giovanni	13 OCT 1985			Men's Discus Throw	61.65	67.36
	289	FASSINOTTI Marco	29 APR 1989			Men's High Jump	2.26	2.33
	290	FEDERICI Andrea	24 FEB 1997			Men's 200 m	20.87	20.80
	291	FERRANTE Francesco	13 MAY 1996			Men's 110 m Hurdles	13.85	13.85
	292	FERRARA Riccardo	22 JAN 2001			Men's Shot Put	19.80	19.80
	293	GATTO Giovanni	10 OCT 1999			Men's 3000 m Steeplechase	8:45.87	8:45.55
	295	LAMBRUGHI Mario	05 FEB 1992			Men's 400 m Hurdles	49.03	48.99
	296	LEONARDI Giuseppe	31 JUL 1996	1.86	78	Men's 400 m	46.26	46.19
	297	LINGUA Marco	04 JUN 1978			Men's Hammer Throw	75.56	79.97



### ENTRY LIST BY NOC

NOC	BIB	SURNAME & NAME	DATE OF BIRTH	HEIGHT	WEIGHT	EVENT	S.BEST	P.BEST
	298	<b>MANDUSIC Max</b>	12 JUN 1998			Men's Pole Vault	<b>5.61</b>	<b>5.61</b>
	299	<b>MELLUZZO Matteo</b>	29 JUL 2002			Men's 100 m	<b>10.32</b>	<b>10.25</b>
	300	<b>MESLEK Ossama</b>	08 JAN 1997			Men's 1500 m	<b>3:37.25</b>	<b>3:37.25</b>
	301	<b>OLIVIERI Giorgio</b>	05 NOV 2000			Men's Hammer Throw	<b>74.39</b>	<b>74.39</b>
	302	<b>ORLANDO Roberto</b>	05 AUG 1995			Men's Javelin Throw	<b>78.19</b>	<b>80.35</b>
	303	<b>PETTOROSSO Diego Aldo</b>	13 JAN 1997			Men's 200 m	<b>20.61</b>	<b>20.61</b>
	305	<b>QUARRATESI Jacopo</b>	29 DEC 2001			Men's Long Jump	<b>7.81</b>	<b>8.00</b>
	306	<b>QUAZZOLA Italo</b>	10 MAY 1994			Men's 5000 m	<b>13:45.18</b>	<b>13:45.18</b>
	308	<b>RIGALI Roberto</b>	07 JAN 1995			Men's 100 m	<b>10.35</b>	<b>10.31</b>
	309	<b>SIMONELLI Lorenzo Ndele</b>	01 JUN 2002			Men's 110 m Hurdles	<b>13.59</b>	<b>13.59</b>
	310	<b>TECUCEANU Catalin</b>	09 SEP 1999			Men's 800 m	<b>1:45.24</b>	<b>1:44.93</b>
		<b>ITALY</b>				Men's 4 x 100 Relay		
	275	ALI Chituru	06 APR 1999					
	290	FEDERICI Andrea	24 FEB 1997					
	294	GUGLIELMI Federico	01 MAR 2002					
	299	MELLUZZO Matteo	29 JUL 2002					
	303	PETTOROSSO Diego Aldo	13 JAN 1997					
	308	RIGALI Roberto	07 JAN 1995					
		<b>ITALY</b>				Men's 4 x 400 Relay		
	278	BENCOSME DE LEON Jose' R	16 MAY 1992					
	280	BIANCIARDI Lapo	06 JUL 1998					
	295	LAMBRUGHIO Mario	05 FEB 1992					
	296	LEONARDI Giuseppe	31 JUL 1996	1.86	78			
	304	PIVOTTO Pietro	29 APR 1995					
	307	RAIMONDI Matteo	22 FEB 2001					

**Total Athletes: 70**



### ENTRY LIST BY NOC

NOC	BIB	SURNAME & NAME	DATE OF BIRTH	HEIGHT	WEIGHT	EVENT	S.BEST	P.BEST
<b>KOS KOSOVO</b>								
	311	<b>BAKRACI Gresa</b>	11 SEP 1995	1.62	50	Women's 1500 m	<b>4:20.56</b>	<b>4:20.56</b>
	312	<b>KRYEZIU Astrit</b>	22 OCT 1991	1.85	73	Men's 800 m	<b>1:52.53</b>	<b>1:48.03</b>
	313	<b>RAMADANI Muhamet</b>	11 AUG 2002	1.92	130	Men's Shot Put	<b>18.72</b>	<b>18.72</b>
	314	<b>SUMA Alaudin</b>	03 APR 2002	1.89	116	Men's Discus Throw	<b>47.59</b>	<b>48.90</b>
<b>Total Athletes: 4</b>								



### ENTRY LIST BY NOC

NOC	BIB	SURNAME & NAME	DATE OF BIRTH	HEIGHT	WEIGHT	EVENT	S.BEST	P.BEST
LBA		<b>LIBYA</b>						
	315	<b>ALGORNI Alaa</b>	14 AUG 1994	1.80	76	Men's 1500 m	<b>3:54.79</b>	<b>3:54.79</b>
	316	<b>AMAAR Ahmed</b>	24 DEC 1997			Men's 100 m	<b>10.63</b>	<b>10.42</b>
	316	<b>AMAAR Ahmed</b>	24 DEC 1997			Men's 200 m	<b>21.10</b>	<b>21.09</b>
	318	<b>ESSABAI Ahmed</b>	25 JUN 2000	1.86	79	Men's 400 m		

**Total Athletes: 3**



## ENTRY LIST BY NOC

NOC	BIB	SURNAME & NAME	DATE OF BIRTH	HEIGHT	WEIGHT	EVENT	S.BEST	P.BEST
<b>MAR MOROCCO</b>								
	319	AZROUR Meryeme	05 DEC 2002	1.68	58	Women's 1500 m	4:15.77	4:14.56
	320	BENKASSEM Khadija	20 APR 1998	1.67	57	Women's 800 m	2:05.58	2:02.44
	321	EDDAOU Hajar	15 AUG 1999	1.66	53	Women's 100 m	11.47	11.47
	321	EDDAOU Hajar	15 AUG 1999	1.66	53	Women's 200 m		24.03
	322	EL HACHIMI Sara	06 JUN 2000	1.68	61	Women's 400 m	53.98	53.98
	323	EL MOUKIM Rkia	22 FEB 1988	1.55	46	Women's Half Marathon	1:11:11	1:11:11
	324	ENNADI Noura	05 APR 1999	1.66	56	Women's 400 m Hurdles	56.50	56.50
	325	ES-SEQALLY Sabah	21 AUG 1997	1.65	53	Women's 3000 m Steeplechas	10:06.73	9:59.30
	326	LAJDOUD Youstra	15 OCT 1997	1.72	61	Women's Long Jump	6.54	6.54
	328	OUAZIZ Ikram	06 JUL 1999	1.65	53	Women's 5000 m		16:23.57
	328	OUAZIZ Ikram	06 JUL 1999	1.65	53	Women's 3000 m Steeplechas	9:53.06	9:44.25
	329	QALLOUJ Hanane	01 FEB 1992	1.68	54	Women's 5000 m		
	329	QALLOUJ Hanane	01 FEB 1992	1.68	54	Women's Half Marathon		1:12:15
	330	RAZIKI Assia	04 OCT 1996	1.73	61	Women's 800 m	2:02.07	2:02.07
	331	SIBA Rhizlane	29 FEB 1996	1.74	49	Women's High Jump	1.85	1.86
	332	TAHIRI Rahma	09 AUG 1998	1.68	52	Women's 5000 m		15:50.71
		<b>MOROCCO</b>				Women's 4 x 400 Relay		
	321	EDDAOU Haiar	15 AUG 1999	1.66	53			
	322	EL HACHIMI Sara	06 JUN 2000	1.68	61			
	324	ENNADI Noura	05 APR 1999	1.66	56			
	327	LEHLALI Salma	04 MAR 2003	1.68	64			
	330	RAZIKI Assia	04 OCT 1996	1.73	61			
	333	BOUASSEL Abderrafia	18 FEB 2001	1.72	62	Men's 3000 m Steeplechase		
	334	BOUQANTAR Soufiyan	30 AUG 1993	1.72	58	Men's 5000 m		
	334	BOUQANTAR Soufiyan	30 AUG 1993	1.72	58	Men's Half Marathon		1:03:11
	335	DAIR Hamza	01 OCT 2002	1.77	67	Men's 400 m	45.69	45.69
	336	EL GUESSE Abdelati	27 FEB 1993	1.73	56	Men's 800 m	1:45.25	1:44.84
	337	FARES Mohamed	06 FEB 1991	1.81	66	Men's 5000 m	13:17.94	13:17.94
	338	HAJJAJI Yassine	23 JUL 2000	1.69	62	Men's Long Jump	7.38	7.80
	339	HAMMADI Mohammed	08 AUG 1997	1.75	61	Men's Triple Jump	15.79	16.38
	340	HINTI Saad	27 APR 2002	1.76	64	Men's 400 m Hurdles	52.98	51.97
	344	M'HAMDI Rachid	02 MAR 2000	1.74	66	Men's 400 m	47.23	47.23
	341	MACHMOUR Chakir	10 FEB 1994	1.77	68	Men's 100 m	10.23	10.23
	341	MACHMOUR Chakir	10 FEB 1994	1.77	68	Men's 200 m	21.18	20.99
	342	MANYANI Ismail	28 MAY 2000	1.77	65	Men's 400 m Hurdles	50.33	50.33
	345	MOUJAHID El Hassane	19 JAN 2000	1.72	62	Men's 1500 m		
	346	OUTALHA Mohcin	15 DEC 1998	1.72	56	Men's Half Marathon		1:00:26
	347	SADIKI Abdellatif	15 JAN 1999	1.76	61	Men's 1500 m	3:33.93	3:33.59
	348	SMAILI Mostafa	09 JAN 1997	1.70	62	Men's 800 m		
	349	TINDOUFT Mohamed	12 MAR 1993	1.79	67	Men's 3000 m Steeplechase	8:20.12	8:11.65
		<b>MOROCCO</b>				Men's 4 x 100 Relay		
	333	BOUASSEL Abderrafia	18 FEB 2001	1.72	62			
	348	SMAILI Mostafa	09 JAN 1997	1.70	62			
		<b>MOROCCO</b>				Men's 4 x 400 Relay		
	335	DAIR Hamza	01 OCT 2002	1.77	67			
	340	HINTI Saad	27 APR 2002	1.76	64			
	342	MANYANI Ismail	28 MAY 2000	1.77	65			
	344	M'HAMDI Rachid	02 MAR 2000	1.74	66			
	345	MOUJAHID El Hassane	19 JAN 2000	1.72	62			
	348	SMAILI Mostafa	09 JAN 1997	1.70	62			
<b>Total Athletes: 30</b>								





## ENTRY LIST BY NOC

NOC	BIB	SURNAME & NAME	DATE OF BIRTH	HEIGHT	WEIGHT	EVENT	S.BEST	P.BEST
<b>MKD</b>	<b>NORTH MAKEDONIA</b>							
	350	<b>ISLAMI BAFTIRI Drita</b>	01 AUG 1996	1.66	57	Women's 400 m Hurdles	<b>59.58</b>	<b>57.53</b>
	352	<b>IVANOVSKI Dario</b>	15 MAY 1997	1.74	64	Men's 5000 m	<b>13:56.59</b>	<b>13:56.59</b>
	353	<b>STOJOSKI Jovan</b>	26 NOV 1997	1.92	80	Men's 400 m	<b>46.99</b>	<b>46.81</b>
	351	<b>TRAIKOV Andreas</b>	18 MAR 1993	1.83	77	Men's Long Jump	<b>7.60</b>	<b>7.83</b>
<b>Total Athletes: 4</b>								



## ENTRY LIST BY NOC

NOC	BIB	SURNAME & NAME	DATE OF BIRTH	HEIGHT	WEIGHT	EVENT	S.BEST	P.BEST
<b>MLT</b>		<b>MALTA</b>						
	354	BEZZINA Lisa Marie	05 NOV 1979	1.70	60	Women's Half Marathon	1:18:10	1:18:10
	355	PACE Rachela	15 JUN 2003	1.65	55	Women's Triple Jump	12.44	12.62
	356	SCHEMBRI Roberta	23 NOV 1990			Women's 5000 m	17:23.66	17:23.66
	357	CAMILLERI Steve	20 JAN 1992	1.80	80	Men's 100 m	10.99	10.62
	358	CASSAR Dillon	01 MAR 1997	1.70	60	Men's Half Marathon		1:06:11
	359	GRECH Ian Paul	18 APR 1993	1.80	75	Men's Triple Jump	14.70	15.20
	360	MICALLEF Benjamin Andrew	27 JAN 1999	1.80	70	Men's 800 m	1:49.07	1:49.07
	361	MIFSUD Bradley	23 JAN 1996	1.90	85	Men's Discus Throw	51.50	51.50
	362	SALIBA Daniel	23 FEB 1995	1.80	75	Men's 110 m Hurdles	14.91	14.69
		<b>Total Athletes: 9</b>						



### ENTRY LIST BY NOC

NOC	BIB	SURNAME & NAME	DATE OF BIRTH	HEIGHT	WEIGHT	EVENT	S.BEST	P.BEST
<b>MNE</b>	<b>MONTENEGRO</b>							
	363	VUKOVIC Marija	21 JAN 1992	1.98	81	Women's High Jump	1.95	1.97
	364	DUROVIC Tomas	14 FEB 1994	1.95	108	Men's Shot Put	19.67	20.60
	365	FURTULA Danijel	31 JUL 1992	1.98	112	Men's Discus Throw	64.31	65.59
		<b>Total Athletes: 3</b>						



### ENTRY LIST BY NOC

NOC	BIB	SURNAME & NAME	DATE OF BIRTH	HEIGHT	WEIGHT	EVENT	S.BEST	P.BEST
<b>MON MONACO</b>								
	366	<b>AFRIAT Charlotte</b>	17 OCT 2002	1.64	60	Women's 100 m	<b>12.78</b>	<b>12.27</b>
	367	<b>GASTAUD Marie-charlotte</b>	30 NOV 1999	1.67	52	Women's 400 m Hurdles		<b>1:04.94</b>
	368	<b>VATRICAN Kylian</b>	01 APR 2004	1.80	70	Men's 100 m		<b>11.35</b>
<b>Total Athletes: 3</b>								



## ENTRY LIST BY NOC

NOC	BIB	SURNAME & NAME	DATE OF BIRTH	HEIGHT	WEIGHT	EVENT	S.BEST	P.BEST
<b>POR PORTUGAL</b>								
	369	BAZOLO Lorene Dorcas	04 MAY 1983	1.70	63	Women's 100 m	11.26	11.10
	369	BAZOLO Lorene Dorcas	04 MAY 1983	1.70	63	Women's 200 m	23.09	22.64
	370	CABRAL DA SILVA Patricia	09 DEC 1999	1.69	54	Women's 800 m	2:04.23	2:04.23
	371	DA COSTA CASSANDRA BARBO	28 FEB 1995	1.65	62	Women's 100 m Hurdles	13.27	13.27
	373	DA SILVA AZEVEDO C tia I	09 MAR 1994	1.70	53	Women's 400 m	51.43	50.59
	374	DA SILVA CA Liliana	05 NOV 1986	1.83	90	Women's Discus Throw	62.47	66.40
	375	DOS SANTOS KGASI Maria R	18 FEB 1998	1.64	53	Women's 100 m	11.47	11.31
	375	DOS SANTOS KGASI Maria R	18 FEB 1998	1.64	53	Women's 200 m	23.94	23.89
	377	MACHADO CARVALHO Mariana	12 NOV 2000	1.69	48	Women's 1500 m	4:11.45	4:10.61
	378	MENDES BARBOSA Vera Leci	13 JAN 1989	1.70	60	Women's 400 m Hurdles	56.37	55.22
	379	TAVARES DA VEIGA Evelise	03 MAR 1996	1.68	51	Women's Long Jump	6.74	6.74
	379	TAVARES DA VEIGA Evelise	03 MAR 1996	1.68	51	Women's Triple Jump	13.50	14.32
		<b>PORTUGAL</b>				Women's 4 x 100 Relay		
	369	BAZOLO Lorene Dorcas	04 MAY 1983	1.70	63			
	371	DA COSTA CASSANDRA BARBO	28 FEB 1995	1.65	62			
	372	DA FONSECA LOURENÇO C.	12 FEB 2000	1.71	60			
	375	DOS SANTOS KGASI Maria R	18 FEB 1998	1.64	53			
	376	GANDULLA MARTINEZ Ariali	22 JUN 1995	1.72	70			
	380	AGOSTINHO COELHO Joao	04 APR 1999	1.87	78	Men's 400 m	45.85	45.85
	381	CANDA DOS SANTOS Delvis	27 JUN 1999	1.74	65	Men's 100 m	10.63	10.52
	381	CANDA DOS SANTOS Delvis	27 JUN 1999	1.74	65	Men's 200 m		
	382	DE OLIVEIRA João Vitor	15 MAY 1992	1.89	85	Men's 110 m Hurdles	13.79	13.45
	383	FRANCISCO ANTUNES Ruben	05 MAY 1999	1.87	95	Men's Hammer Throw		
	384	LARRINAGA HERNÁNDEZ Abde	13 JUL 1994	1.89	90	Men's 110 m Hurdles	13.70	13.70
	385	LUÓS PEREIRA Tiago João	19 SEP 1993	1.94	75	Men's Triple Jump	16.72	17.11
	386	MARQUES PINTO José Carlo	03 MAY 1997	1.78	60	Men's 800 m	1:46.61	1:46.61
	387	MENDES BARROS Etson	16 MAR 2001	1.91	72	Men's 3000 m Steeplechase	8:25.98	8:25.98
	388	RAMOS Leandro Parreças	21 SEP 2000	1.83	93	Men's Javelin Throw	84.78	84.78
	389	ROSENOV ARNAUDOV Tsanko	14 MAR 1992	1.98	155	Men's Shot Put	20.43	21.56
	390	VARELA BALDE Gerson	28 JAN 2000	1.94	78	Men's High Jump	2.22	2.23
	391	VILA BARATA Samuel	19 JUL 1993	1.75	60	Men's 5000 m	13:47.06	13:31.90

Total Athletes: 23



## ENTRY LIST BY NOC

NOC	BIB	SURNAME & NAME	DATE OF BIRTH	HEIGHT	WEIGHT	EVENT	S.BEST	P.BEST
<b>SLO SLOVENIA</b>								
	392	<b>FILIPIC Neja</b>	22 APR 1995	1.70	58	Women's Long Jump	<b>6.49</b>	<b>6.56</b>
	392	<b>FILIPIC Neja</b>	22 APR 1995	1.70	58	Women's Triple Jump	<b>14.42</b>	<b>12.98</b>
	393	<b>HORVAT Anita</b>	07 SEP 1996	1.74	57	Women's 400 m	<b>52.71</b>	<b>51.22</b>
	394	<b>PEPELNAK Eva</b>	04 OCT 2000	1.80	64	Women's Triple Jump	<b>13.53</b>	<b>13.70</b>
	396	<b>SMONKAR Jerneja</b>	27 JAN 1992	1.70	55	Women's 800 m	<b>2:03.55</b>	<b>2:03.37</b>
	397	<b>ZUPIN Agata</b>	17 MAR 1998	1.80	67	Women's 400 m Hurdles	<b>56.84</b>	<b>55.96</b>
		<b>SLOVENIA</b>				Women's 4 x 400 Relay		
	393	HORVAT Anita	07 SEP 1996	1.74	57			
	395	POGOREVC Maia	31 JUL 1996	1.74	58			
	396	SMONKAR Jerneja	27 JAN 1992	1.70	55			
	397	ZUPIN Agata	17 MAR 1998	1.80	67			
	398	<b>DEMSAR Filip Jakob</b>	03 APR 2000	1.87	83	Men's 110 m Hurdles	<b>13.74</b>	<b>13.69</b>
	401	<b>GRKMAN Jure</b>	29 SEP 1999	1.82	78	Men's 200 m		<b>20.95</b>
	403	<b>LUXA Jan</b>	11 FEB 1996	1.91	83	Men's Triple Jump	<b>15.86</b>	<b>16.23</b>
	405	<b>RENNER Robert</b>	08 MAR 1994	1.83	77	Men's Pole Vault	<b>5.61</b>	<b>5.70</b>
		<b>SLOVENIA</b>				Men's 4 x 400 Relay		
	399	FERLAN Rok	26 JUL 1997	1.78	73			
	400	GRAHOVAC Gregor	24 APR 2000	1.87	78			
	401	GRKMAN Jure	29 SEP 1999	1.82	78			
	404	MESEC KOSIR Lovro	11 AUG 1999	1.84	70			

**Total Athletes: 13**



## ENTRY LIST BY NOC

NOC	BIB	SURNAME & NAME	DATE OF BIRTH	HEIGHT	WEIGHT	EVENT	S.BEST	P.BEST
<b>SMR</b>	<b>SAN MARINO</b>							
	406	<b>BERTI Beatrice</b>	06 DEC 1999	1.70	58	Women's 400 m Hurdles	<b>1:04.37</b>	<b>1:02.03</b>
	407	<b>GASPARELLI Alessandra</b>	03 SEP 2004	1.62	53	Women's 100 m	<b>11.67</b>	<b>11.67</b>
	407	<b>GASPARELLI Alessandra</b>	03 SEP 2004	1.62	53	Women's 200 m	<b>24.81</b>	<b>24.81</b>
	408	<b>ERCOLANI VOLTA Andrea</b>	20 APR 1995	1.77	73	Men's 400 m Hurdles	<b>52.32</b>	<b>52.32</b>
	409	<b>MOLINARI Francesco</b>	29 OCT 1994	1.80	75	Men's 100 m	<b>10.70</b>	<b>10.70</b>
	410	<b>SANSOVINI Francesco</b>	18 JAN 2000	1.78	78	Men's 100 m	<b>10.47</b>	<b>10.47</b>

**Total Athletes: 5**



## ENTRY LIST BY NOC

NOC	BIB	SURNAME & NAME	DATE OF BIRTH	HEIGHT	WEIGHT	EVENT	S.BEST	P.BEST
<b>SRB</b>		<b>SERBIA</b>						
	411	GARDASEVIC Milica	28 SEP 1998			Women's Long Jump	6.81	6.81
	412	ILIC Ivana	08 JUN 2002			Women's 100 m	11.83	11.38
	412	ILIC Ivana	08 JUN 2002			Women's 200 m		23.62
	413	LUKIC Anja	30 MAY 1999			Women's 100 m Hurdles	13.29	13.29
	414	MILUTINOVIC Tamara	18 NOV 2001			Women's 200 m	24.71	24.14
	415	VILAGOS Adriana	02 JAN 2004			Women's Javelin Throw	62.76	62.76
	417	ANIC Lazar	14 DEC 1991	1.99	81	Men's Long Jump	7.75	8.15
	418	BIBIC Elzan	08 JAN 1999			Men's 1500 m		3:35.07
	420	KOLASINAC Asmir	15 OCT 1984			Men's Shot Put	21.06	21.58
	421	SINANCEVIC Armin	14 AUG 1996			Men's Shot Put	21.04	21.88
		<b>Total Athletes: 9</b>						





### ENTRY LIST BY NOC

<i>NOC</i>	<i>BIB</i>	<i>SURNAME &amp; NAME</i>	<i>DATE OF BIRTH</i>	<i>HEIGHT</i>	<i>WEIGHT</i>	<i>EVENT</i>	<i>S.BEST</i>	<i>P.BEST</i>
<b>SYR</b>		<b>SYRIA</b>						
	422	<b>GHAZAL Majd Eddin</b>	21 APR 1987	1.95	78	Men's High Jump	<b>2.26</b>	<b>2.36</b>
		<b>Total Athletes: 1</b>						



## ENTRY LIST BY NOC

NOC	BIB	SURNAME & NAME	DATE OF BIRTH	HEIGHT	WEIGHT	EVENT	S.BEST	P.BEST
<b>TUN TUNISIA</b>								
	423	<b>BOUZAYANI Marwa</b>	26 MAR 1997	1.72	58	Women's 3000 m Steeplechas	<b>9:23.57</b>	<b>9:23.57</b>
	424	<b>AYOUNI Abdessalem</b>	16 MAY 1994	1.80	75	Men's 800 m	<b>1:46.12</b>	<b>1:44.99</b>
	424	<b>AYOUNI Abdessalem</b>	16 MAY 1994	1.80	75	Men's 1500 m		<b>3:37.30</b>
	425	<b>BALTI Rami</b>	08 JAN 2001	1.84	74	Men's 400 m	<b>46.92</b>	<b>46.62</b>
	426	<b>CHNINNI Riadh</b>	15 MAR 1997	1.80	63	Men's 800 m	<b>1:46.91</b>	<b>1:46.24</b>
	426	<b>CHNINNI Riadh</b>	15 MAR 1997	1.80	63	Men's 1500 m	<b>3:41.20</b>	<b>3:41.20</b>
	427	<b>JAZIRI Ahmed</b>	16 DEC 1997	1.75	60	Men's 5000 m		
	427	<b>JAZIRI Ahmed</b>	16 DEC 1997	1.75	60	Men's 3000 m Steeplechase	<b>8:18.70</b>	<b>8:18.70</b>
	428	<b>JHINAOUI Mohamed Amin</b>	02 APR 1997	1.80	70	Men's 3000 m Steeplechase	<b>8:16.38</b>	<b>8:16.38</b>
	430	<b>JLASSI Mohamed Fares</b>	09 JAN 1997	1.83	79	Men's 400 m	<b>45.54</b>	<b>45.54</b>
	431	<b>SAAD Atef</b>	20 MAR 1988	1.75	56	Men's Half Marathon		<b>1:04:54</b>
	432	<b>TOUATI Mohamed Amine</b>	09 SEP 1998	1.80	70	Men's 400 m Hurdles	<b>50.34</b>	<b>49.14</b>
		<b>TUNISIA</b>				Men's 4 x 400 Relay		
	424	AYOUNI Abdessalem	16 MAY 1994	1.80	75			
	425	BALTI Rami	08 JAN 2001	1.84	74			
	426	CHNINNI Riadh	15 MAR 1997	1.80	63			
	430	JLASSI Mohamed Fares	09 JAN 1997	1.83	79			
	432	TOUATI Mohamed Amine	09 SEP 1998	1.80	70			
<b>Total Athletes: 9</b>								



ENTRY LIST BY NOC

NOC	BIB	SURNAME & NAME	DATE OF BIRTH	HEIGHT	WEIGHT	EVENT	S.BEST	P.BEST	
<b>TUR</b>		<b>TURKIYE</b>							
	434	AY Mizgin	01 JAN 2000			Women's 100 m	11.74	11.53	
	434	AY Mizgin	01 JAN 2000			Women's 200 m		23.49	
	435	AYAZ Seval	25 SEP 2000			Women's 100 m Hurdles	13.45	13.26	
	436	AYILDIZ Silan	10 OCT 1999			Women's 1500 m	4:10.59	4:10.59	
	437	BECEREK Ozlem	22 APR 2002			Women's Discus Throw	57.58	59.15	
	438	CAN Yasemin	11 DEC 1996			Women's 5000 m	14:41.40	14:36.82	
	439	DANISMAZ Tugba	01 SEP 1999			Women's Triple Jump	14.07	14.09	
	440	EKATERINE Guliyev	01 MAR 1991			Women's 800 m	2:02.14	1:57.53	
	441	ERDOGAN Meryem	24 APR 1990			Women's Half Marathon	1:10:16	1:10:16	
	442	ESRA Turkmen	20 JAN 2002			Women's Javelin Throw	56.59	56.59	
	443	GUVENC Tugba	09 JUL 1994			Women's 3000 m Steeplechas	9:37.15	9:26.09	
	444	MECHAAL Emine Hatun	07 DEC 1995			Women's 1500 m		4:19.27	
	444	MECHAAL Emine Hatun	07 DEC 1995			Women's 5000 m	16:09.34	16:03.90	
	445	SALMAN Kivilcim Kaya	27 MAR 1992			Women's Hammer Throw	69.10	72.55	
	446	SAVASKAN Buse	24 FEB 1999			Women's High Jump	1.88	1.88	
	447	TOPTAS Tugba	11 JUL 2000			Women's 800 m			
	448	TUGSUZ Eda	27 MAR 1997			Women's Javelin Throw	57.47	67.21	
	449	YILDIRIM Busra	10 MAY 1996			Women's 400 m	52.88	52.88	
		<b>TURKIYE</b>				Women's 4 x 400 Relay			
	434	AY Mizgin	01 JAN 2000						
	435	AYAZ Seval	25 SEP 2000						
	440	EKATERINE Guliyev	01 MAR 1991						
	449	YILDIRIM Busra	10 MAY 1996						
	447	TOPTAS Tugba	11 JUL 2000						
	450	ACET Alperen	02 APR 1998			Men's High Jump	2.20	2.30	
	451	ATAC Sezgin	21 MAR 1998			Men's Half Marathon			
	452	BALTACI Ozkan	13 FEB 1994			Men's Hammer Throw			
	453	BARBAROS Ramazan	05 JAN 1998			Men's 1500 m	3:45.25	3:39.18	
	453	BARBAROS Ramazan	05 JAN 1998			Men's 5000 m			
	454	CANKAYA Enes	21 MAR 2002			Men's Discus Throw	58.27	58.27	
	455	ER Necati	24 FEB 1997			Men's Long Jump		7.83	
	455	ER Necati	24 FEB 1997			Men's Triple Jump	16.44	17.37	
	456	ESCOBAR Yasmani Copello	15 APR 1987			Men's 400 m Hurdles	49.11	47.81	
	457	GULIYEV Ramil	29 MAY 1990			Men's 100 m	10.26	9.97	
	457	GULIYEV Ramil	29 MAY 1990			Men's 200 m	20.62	19.76	
	458	HARVEY Jak Ali	04 MAY 1989			Men's 100 m	10.25	9.92	
	458	HARVEY Jak Ali	04 MAY 1989			Men's 200 m			
	459	KAYA Aras	04 APR 1994			Men's 5000 m	13:44.03	13:23.91	
	469	KAYA Oguzhan	04 APR 2001			Men's 400 m			
	460	NEZIR Ismail	22 JAN 2003			Men's 400 m Hurdles	50.91	50.91	
	461	ONCEL Emin	01 MAY 1997			Men's Javelin Throw	81.20	81.37	
	462	OREN Sinan	10 FEB 1998			Men's 400 m	46.13	46.13	
	463	OZDEMIR Ramazan	06 JUL 1991			Men's Half Marathon	1:03:10	1:03:10	
	465	SAHIN Omer	02 JUN 1995			Men's Discus Throw	60.16	60.16	
	466	SASMA Ersu	30 SEP 1999			Men's Pole Vault	5.60	5.80	
	467	SEVLER Mikdat	21 JAN 1998			Men's 110 m Hurdles	13.56	13.42	
	468	TOKSOZ Salih	01 JAN 1994			Men's 800 m	1:48.51	1:48.51	
	470	YEGO Hilal	02 APR 1992			Men's 3000 m Steeplechase	8:37.03	8:03.57	
		<b>TURKIYE</b>				Men's 4 x 100 Relay			
	457	GULIYEV Ramil	29 MAY 1990						
	458	HARVEY Jak Ali	04 MAY 1989						
	464	OZER Kayhan	11 JUN 1998						
	481	OZKAN Ertan	01 SEP 1996						
	467	SEVLER Mikdat	21 JAN 1998						
		<b>TURKIYE</b>				Men's 4 x 400 Relay			
	456	ESCOBAR Yasmani Copello	15 APR 1987						
	469	KAYA Oguzhan	04 APR 2001						
	460	NEZIR Ismail	22 JAN 2003						
	462	OREN Sinan	10 FEB 1998						
	468	TOKSOZ Salih	01 JAN 1994						
	<b>Total Athletes: 38</b>								



Complexe Olympique - Grand Stade  
Athletic



**ENTRY LIST BY NOC**

<i>NOC</i>	<i>BIB</i>	<i>SURNAME &amp; NAME</i>	<i>DATE OF BIRTH</i>	<i>HEIGHT</i>	<i>WEIGHT</i>	<i>EVENT</i>	<i>S.BEST</i>	<i>P.BEST</i>
	480	<b>CARNICELLI Sara</b>	31 OCT 1994			Women's Half Marathon		
		<b>Total Athletes: 1</b>						



## RESULTS

RANK BIB SURNAME & NAME NOC DATE OF BIRTH LANE R.T. TIME

WR	9.58	BOLT Usain	1986	JAM	BERLIN	16 AUG 2009
CR	10.10	HARVEY Jak Ali	2018	TUR	Tarragona	28 JUN 2018

As of 30/06/2022 at 20:53

(Wind: +0.9 m/s)

RANK	BIB	SURNAME & NAME	NOC	DATE OF BIRTH	LANE	R.T.	TIME	
1	458	HARVEY Jak Ali	TUR	04 MAY 1989	6	0.129	<b>10.15</b>	SB
2	457	GULIYEV Ramil	TUR	29 MAY 1990	5	0.149	<b>10.16</b>	SB
3	230	NYFANTOPOULOS Ioannis	GRE	01 NOV 1990	7	0.155	<b>10.28</b>	PB
4	299	MELLUZZO Matteo	ITA	29 JUL 2002	3	0.148	<b>10.28</b>	SB
5	143	LOPEZ BARRANCO Sergio	ESP	05 JUL 1999	4	0.132	<b>10.33</b>	
6	308	RIGALI Roberto	ITA	07 JAN 1995	2	0.156	<b>10.39</b>	
7	55	SAHEL Youcef	ALG	17 NOV 1993	8	0.143	<b>10.43</b>	PB
8	410	SANSOVINI Francesco	SMR	18 JAN 2000	1	0.165	<b>10.48</b>	

Details:

Start time:20:50

Temperature:+23°C

Humidity:80%



### Legend

DNF = Did Not Finish  
DQ = Disqualified  
PB = Personal Best  
SB = Season's Best

DNS = Did Not Start  
Fn = False Start  
R.T. = Reaction

Oran 30 Juin - 3 Juillet

ATHM100M-----FNL-000100--\_73A 1.0 Data Processing and Timing by Microplus - www.microplustiming.com

1



## RESULTS

RANK BIB SURNAME & NAME NOC DATE OF BIRTH LANE R.T. TIME

WR	9.58	BOLT Usain	1986	JAM	BERLIN	16 AUG 2009
CR	10.10	HARVEY Jak Ali	2018	TUR	Tarragona	28 JUN 2018

As of 30/06/2022 at 19:02

(Wind: +0.6 m/s)

RANK	BIB	SURNAME & NAME	NOC	DATE OF BIRTH	LANE	R.T.	TIME
1	299	MELLUZZO Matteo	ITA	29 JUL 2002	7	0.154	10.36 Q
2	143	LOPEZ BARRANCO Sergio	ESP	05 JUL 1999	5	0.151	10.38 Q
3	55	SAHEL Youcef	ALG	17 NOV 1993	2	0.139	10.42 Q
4	381	CANDA DOS SANTOS Delvis	POR	27 JUN 1999	3	0.200	10.50
5	239	ZIKOS Konstantinos	GRE	24 APR 1998	8	0.197	10.54
6	341	MACHMOUR Chakir	MAR	10 FEB 1994	9	0.195	10.61
7	95	BEECHY Alexander	CYP	08 JUN 1991	4	0.170	10.81
8	357	CAMILLERI Steve	MLT	20 JAN 1992	6	0.182	11.28

### NOT RANKED

316 AMAAR Ahmed LBA 24 DEC 1997 10 DNF

Qualification: First 3 in each heat (Q) and 2 fastest (q) to Final

Details: Start time:19:00 Temperature:+24°C Humidity:80%

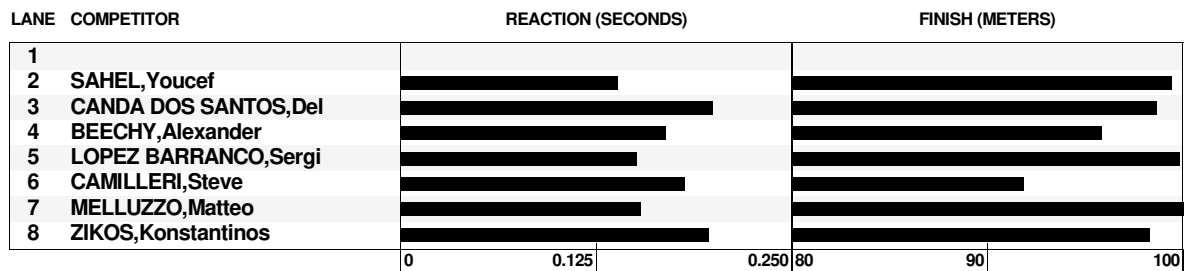

#### Legend

DNF = Did Not Finish  
DQ = Disqualified  
R.T. = Reaction  
DNS = Did Not Start  
Fn = False Start

Oran 30 Juin - 3 Juillet

ATHM100M-----RND1000100--\_73A 1.0 Data Processing and Timing by Microplus - www.microplustiming.com

1



## RESULTS

RANK BIB SURNAME & NAME NOC DATE OF BIRTH LANE R.T. TIME

WR	9.58	BOLT Usain	1986	JAM	BERLIN	16 AUG 2009
CR	10.10	HARVEY Jak Ali	2018	TUR	Tarragona	28 JUN 2018

As of 30/06/2022 at 19:13

(Wind: +0.4 m/s)

RANK	BIB	SURNAME & NAME	NOC	DATE OF BIRTH	LANE	R.T.	TIME
1	458	HARVEY Jak Ali	TUR	04 MAY 1989	1	0.122	10.22 Q
2	457	GULIYEV Ramil	TUR	29 MAY 1990	6	0.151	10.24 Q
3	230	NYFANTOPOULOS Ioannis	GRE	01 NOV 1990	9	0.167	10.34 Q
4	308	RIGALI Roberto	ITA	07 JAN 1995	2	0.153	10.41 q
5	410	SANSOVINI Francesco	SMR	18 JAN 2000	3	0.172	10.49 q
6	31	ATHMANI Skander Djamil	ALG	21 JUN 1992	5	0.139	10.56
7	72	VEJZOVIC Hajrudin	BIH	01 DEC 2000	10	0.122	10.60
8	73	VIKALO Edhem	BIH	21 JAN 2002	7	0.156	10.64
9	409	MOLINARI Francesco	SMR	29 OCT 1994	8	0.146	10.81
10	368	VATRICAN Kylian	MON	01 APR 2004	4	0.221	11.50

Qualification: First 3 in each heat (Q) and 2 fastest (q) to Final

Details:

Start time:19:08

Temperature:+24°C

Humidity:80%

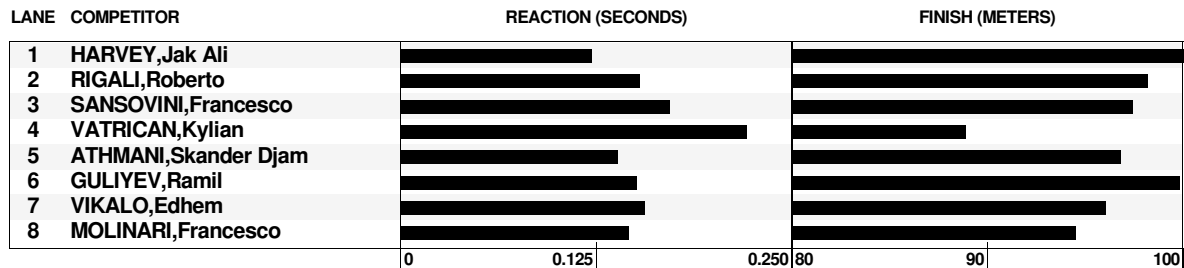

### Legend

DNF = Did Not Finish  
DQ = Disqualified  
R.T. = Reaction

DNS = Did Not Start  
Fn = False Start

Oran 30 Juin - 3 Juillet

ATHM100M-----RND1000100--\_73A 1.0 Data Processing and Timing by Microplus - www.microplustiming.com

2



## SUMMARY

RANK BIB SURNAME & NAME NOC DATE OF BIRTH HEAT LANE RANK WIND TIME

WR	9.58	BOLT Usain	1986	JAM	BERLIN	16 AUG 2009
CR	10.10	HARVEY Jak Ali	2018	TUR	Tarragona	28 JUN 2018

1	458	HARVEY Jak Ali	TUR	04 MAY 1989	2	1	1	+0.4	<b>10.22</b>	Q
2	457	GULIYEV Ramil	TUR	29 MAY 1990	2	6	2	+0.4	<b>10.24</b>	Q
3	230	NYFANTOPOULOS Ioannis	GRE	01 NOV 1990	2	9	3	+0.4	<b>10.34</b>	Q
4	299	MELLUZZO Matteo	ITA	29 JUL 2002	1	7	1	+0.6	<b>10.36</b>	Q
5	143	LOPEZ BARRANCO Sergio	ESP	05 JUL 1999	1	5	2	+0.6	<b>10.38</b>	Q
6	308	RIGALI Roberto	ITA	07 JAN 1995	2	2	4	+0.4	<b>10.41</b>	q
7	55	SAHEL Youcef	ALG	17 NOV 1993	1	2	3	+0.6	<b>10.42</b>	Q
8	410	SANSOVINI Francesco	SMR	18 JAN 2000	2	3	5	+0.4	<b>10.49</b>	q
9	381	CANDA DOS SANTOS Delvis	POR	27 JUN 1999	1	3	4	+0.6	<b>10.50</b>	
10	239	ZIKOS Konstantinos	GRE	24 APR 1998	1	8	5	+0.6	<b>10.54</b>	
11	31	ATHMANI Skander Djamil	ALG	21 JUN 1992	2	5	6	+0.4	<b>10.56</b>	
12	72	VEJZOVIC Hajrudin	BIH	01 DEC 2000	2	10	7	+0.4	<b>10.60</b>	
13	341	MACHMOUR Chakir	MAR	10 FEB 1994	1	9	6	+0.6	<b>10.61</b>	
14	73	VIKALO Edhem	BIH	21 JAN 2002	2	7	8	+0.4	<b>10.64</b>	
15	95	BEECHY Alexander	CYP	08 JUN 1991	1	4	7	+0.6	<b>10.81</b>	
15	409	MOLINARI Francesco	SMR	29 OCT 1994	2	8	9	+0.4	<b>10.81</b>	
17	357	CAMILLERI Steve	MLT	20 JAN 1992	1	6	8	+0.6	<b>11.28</b>	
18	368	VATRICAN Kylian	MON	01 APR 2004	2	4	10	+0.4	<b>11.50</b>	

## NOT RANKED

316 AMAAR Ahmed LBA 24 DEC 1997 1 10 +0.6 DNF

Qualification: First 3 in each heat (Q) and 2 fastest (q) to Final

### Legend

DNF = Did Not Finish  
DQ = Disqualified  
R.T. = Reaction

DNS = Did Not Start  
Fn = False Start

Oran 30 Juin - 3 Juillet

ATHM100M-----RND1-----\_74A 1.0 Data Processing and Timing by Microplus - www.microplustiming.com

1





## RESULTS

RANK	BIB	SURNAME & NAME	NOC	DATE OF BIRTH	LANE	R.T.	TIME
WR	19.19	BOLT Usain	JAM	1986	BERLIN		20 AUG 2009
CR	20.15	GULIYEV Ramil	TUR	2018	Tarragona		29 JUN 2018

As of 03/07/2022 at 18:25

(Wind: +0.8 m/s)

RANK	BIB	SURNAME & NAME	NOC	DATE OF BIRTH	LANE	R.T.	TIME	SB
1	457	GULIYEV Ramil	TUR	29 MAY 1990	6	0.166	20.21	SB
2	303	PETTOROSSO Diego Aldo	ITA	13 JAN 1997	5	0.175	20.65	
3	147	RODRIGUEZ SERRANO Daniel	ESP	26 JAN 1995	7	0.154	20.78	
4	341	MACHMOUR Chakir	MAR	10 FEB 1994	3	0.183	20.94	
5	234	TRIVYZAS Panagiotis	GRE	22 NOV 1987	8	0.170	20.99	
6	381	CANDA DOS SANTOS Delvis	POR	27 JUN 1999	2	0.164	21.06	
7	290	FEDERICI Andrea	ITA	24 FEB 1997	4	0.162	21.25	
8	93	AVGOUSTINOUS Stavros	CYP	11 AUG 1998	1	0.181	21.55	

Details: Start time:18:20 Temperature:+27°C Humidity:70%



### Legend

DNF = Did Not Finish	DNS = Did Not Start
DQ = Disqualified	Fn = False Start
R.T. = Reaction	SB = Season's Best

Oran 30 Juin - 3 Juillet

ATHM200M-----FNL-000100--\_73A 1.0 Data Processing and Timing by Microplus - www.microplustiming.com

1



## RESULTS

RANK	BIB	SURNAME & NAME	NOC	DATE OF BIRTH	LANE	R.T.	TIME
WR	19.19	BOLT Usain	JAM	1986	BERLIN		20 AUG 2009
CR	20.15	GULIYEV Ramil	TUR	2018	Tarragona		29 JUN 2018

As of 02/07/2022 at 19:02

(Wind: +0.9 m/s)

RANK	BIB	SURNAME & NAME	NOC	DATE OF BIRTH	LANE	R.T.	TIME
1	303	PETTOROSSO Diego Aldo	ITA	13 JAN 1997	7	0.167	20.55 Q
2	341	MACHMOUR Chakir	MAR	10 FEB 1994	6	0.185	20.77 Q PB
3	147	RODRIGUEZ SERRANO Daniel	ESP	26 JAN 1995	2	0.170	20.86 Q
4	381	CANDA DOS SANTOS Delvis	POR	27 JUN 1999	1	0.164	21.14 q
5	93	AVGOUSTINOUS Stavros	CYP	11 AUG 1998	5	0.164	21.22 q PB
6	55	SAHEL Youcef	ALG	17 NOV 1993	3	0.164	21.27
7	316	AMAAR Ahmed	LBA	24 DEC 1997	4	0.162	21.63

Qualification: First 3 in each heat (Q) and 2 fastest (q) to Final

Details:

Start time:19:01

Temperature:+26°C

Humidity:65%

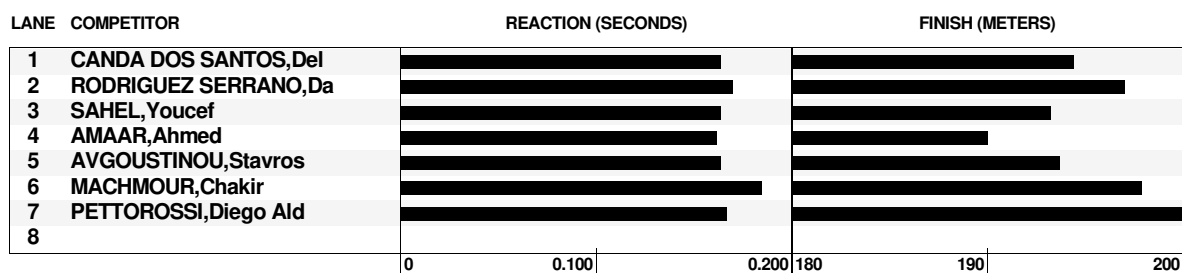

### Legend

DNF = Did Not Finish  
DQ = Disqualified  
PB = Personal Best

DNS = Did Not Start  
Fn = False Start  
R.T. = Reaction

Oran 30 Juin - 3 Juillet

ATHM200M-----RND1000100--\_73A 1.0 Data Processing and Timing by Microplus - www.microplustiming.com

1



## RESULTS

RANK BIB SURNAME & NAME NOC DATE OF BIRTH LANE R.T. TIME

WR	19.19	BOLT Usain	1986	JAM	BERLIN	20 AUG 2009
CR	20.15	GULIYEV Ramil	2018	TUR	Tarragona	29 JUN 2018

As of 02/07/2022 at 19:09

(Wind: +0.9 m/s)

RANK	BIB	SURNAME & NAME	NOC	DATE OF BIRTH	LANE	R.T.	TIME
1	457	GULIYEV Ramil	TUR	29 MAY 1990	7	0.176	20.74 Q
2	290	FEDERICI Andrea	ITA	24 FEB 1997	3	0.151	21.05 Q
3	234	TRIVYZAS Panagiotis	GRE	22 NOV 1987	2	0.150	21.08 Q
4	401	GRKMAN Jure	SLO	29 SEP 1999	1	0.216	21.44
5	224	KARIOFYLLIS Ioannis	GRE	18 SEP 2002	5	0.173	21.46
6	95	BEECHY Alexander	CYP	08 JUN 1991	6	0.164	21.57

### NOT RANKED

31	ATHMANI Skander Djamil	ALG	21 JUN 1992	8	DNS
458	HARVEY Jak Ali	TUR	04 MAY 1989	4	DNS

Qualification: First 3 in each heat (Q) and 2 fastest (q) to Final

Details:

Start time:19:08

Temperature:+26°C

Humidity:65%

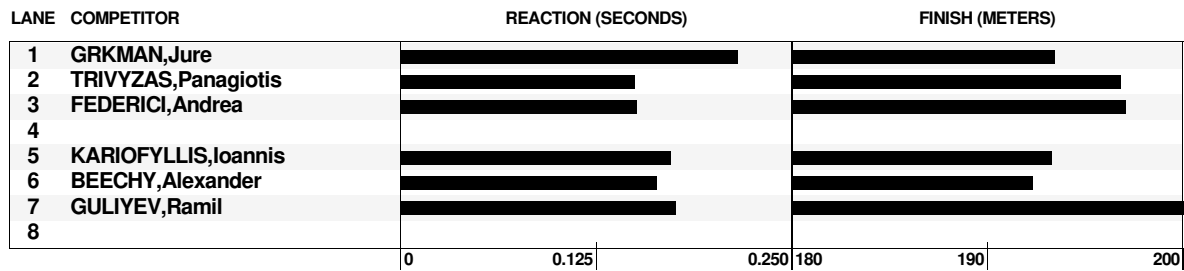

#### Legend

DNF = Did Not Finish  
DQ = Disqualified  
PB = Personal Best

DNS = Did Not Start  
Fn = False Start  
R.T. = Reaction

Oran 30 Juin - 3 Juillet

ATHM200M-----RND1000100--\_73A 1.0 Data Processing and Timing by Microplus - www.microplustiming.com

2



## SUMMARY

RANK	BIB	SURNAME & NAME	NOC	DATE OF BIRTH	HEAT	LANE	RANK	WIND	TIME	
<b>WR</b>	<b>19.19</b>	<b>BOLT Usain</b>		1986	JAM	BERLIN			20 AUG 2009	
<b>CR</b>	<b>20.15</b>	<b>GULIYEV Ramil</b>		2018	TUR	Tarragona			29 JUN 2018	
1	303	<b>PETTOROSSO Diego Aldo</b>	ITA	13 JAN 1997	1	7	1	+0.9	<b>20.55</b>	Q
2	457	<b>GULIYEV Ramil</b>	TUR	29 MAY 1990	2	7	1	+0.9	<b>20.74</b>	Q
3	341	<b>MACHMOUR Chakir</b>	MAR	10 FEB 1994	1	6	2	+0.9	<b>20.77</b>	Q PB
4	147	<b>RODRIGUEZ SERRANO Daniel</b>	ESP	26 JAN 1995	1	2	3	+0.9	<b>20.86</b>	Q
5	290	<b>FEDERICI Andrea</b>	ITA	24 FEB 1997	2	3	2	+0.9	<b>21.05</b>	Q
6	234	<b>TRIVYZAS Panagiotis</b>	GRE	22 NOV 1987	2	2	3	+0.9	<b>21.08</b>	Q
7	381	<b>CANDA DOS SANTOS Delvis</b>	POR	27 JUN 1999	1	1	4	+0.9	<b>21.14</b>	q
8	93	<b>AVGOUSTINOUS Stavros</b>	CYP	11 AUG 1998	1	5	5	+0.9	<b>21.22</b>	q PB
9	55	<b>SAHEL Youcef</b>	ALG	17 NOV 1993	1	3	6	+0.9	<b>21.27</b>	
10	401	<b>GRKMAN Jure</b>	SLO	29 SEP 1999	2	1	4	+0.9	<b>21.44</b>	
11	224	<b>KARIOFYLLIS Ioannis</b>	GRE	18 SEP 2002	2	5	5	+0.9	<b>21.46</b>	
12	95	<b>BEECHY Alexander</b>	CYP	08 JUN 1991	2	6	6	+0.9	<b>21.57</b>	
13	316	<b>AMAAR Ahmed</b>	LBA	24 DEC 1997	1	4	7	+0.9	<b>21.63</b>	

## NOT RANKED

31		<b>ATHMANI Skander Djamil</b>	ALG	21 JUN 1992	2	8		+0.9	<b>DNS</b>	
458		<b>HARVEY Jak Ali</b>	TUR	04 MAY 1989	2	4		+0.9	<b>DNS</b>	

Qualification: First 3 in each heat (Q) and 2 fastest (q) to Final

### Legend

**DNF** = Did Not Finish  
**DQ** = Disqualified  
**PB** = Personal Best

**DNS** = Did Not Start  
**Fn** = False Start  
**R.T.** = Reaction



## RESULTS

RANK	BIB	SURNAME & NAME	NOC	DATE OF BIRTH	LANE	R.T.	TIME
WR	43.03	VAN NIEKERK Wayde	1992	RSA	RIO DE JANEI		14 AUG 2016
CR	45.26	RE Davide	2018	ITA	Tarragona		28 JUN 2018

### As of 02/07/2022 at 19:39

RANK	BIB	SURNAME & NAME	NOC	DATE OF BIRTH	LANE	R.T.	TIME	STATUS
1	380	AGOSTINHO COELHO Joao	POR	04 APR 1999	3	0.226	45.41	PB
2	335	DAIR Hamza	MAR	01 OCT 2002	6	0.225	45.65	PB
3	32	BENDJEMAA Abdennour	ALG	22 MAY 1994	2	0.200	46.06	PB
4	2	BURRAJ Franko	ALB	19 AUG 1998	5	0.203	46.16	PB
5	134	CANAL GARCIA Inaki	ESP	30 SEP 1997	7	0.170	46.44	
6	44	HAMMOUNI Anas Es Saddik	ALG	10 NOV 1995	8	0.165	46.77	
7	280	BIANCIARDI Lapo	ITA	06 JUL 1998	1	0.173	47.02	

### NOT RANKED

430	JLASSI Mohamed Fares	TUN	09 JAN 1997	4				DNF
-----	----------------------	-----	-------------	---	--	--	--	-----

Details: Start time:19:35 Temperature:+25°C Humidity:70%

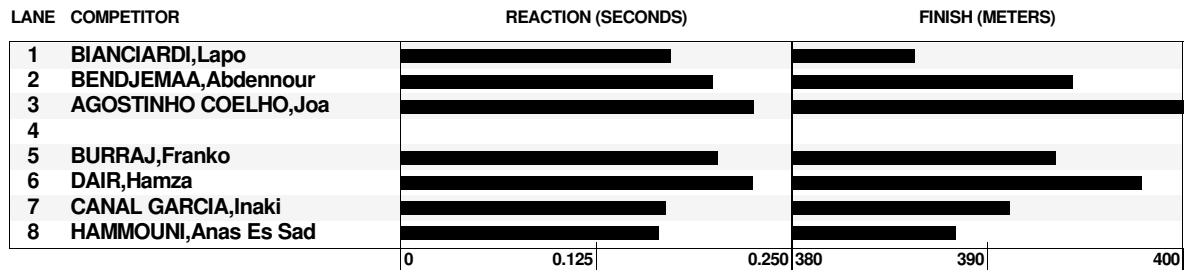

### Legend

DNF = Did Not Finish      DNS = Did Not Start  
DQ = Disqualified      Fn = False Start  
PB = Personal Best      R.T. = Reaction

Oran 30 Juin - 3 Juillet

ATHM400M-----FNL-000100--\_73A 1.0 Data Processing and Timing by Microplus - www.microplustiming.com

1



## RESULTS

RANK	BIB	SURNAME & NAME	NOC	DATE OF BIRTH	LANE	R.T.	TIME
WR	43.03	VAN NIEKERK Wayde	1992	RSA	RIO DE JANEI		14 AUG 2016
CR	45.26	RE Davide	2018	ITA	Tarragona		28 JUN 2018

### As of 01/07/2022 at 18:22

1	430	JLASSI Mohamed Fares	TUN	09 JAN 1997	7	0.152	45.94 Q
2	134	CANAL GARCIA Inaki	ESP	30 SEP 1997	2	0.149	46.31 Q
3	280	BIANCIARDI Lapo	ITA	06 JUL 1998	4	0.153	46.33 q
4	353	STOJOSKI Jovan	MKD	26 NOV 1997	6	0.202	47.07
5	462	OREN Sinan	TUR	10 FEB 1998	5	0.289	47.10
6	318	ESSABAI Ahmed	LBA	25 JUN 2000	3	0.284	52.49

Qualification: First 2 in each heat (Q) and 2 fastest (q) to Final

Details: Start time:18:20 Temperature:+26°C Humidity:75%

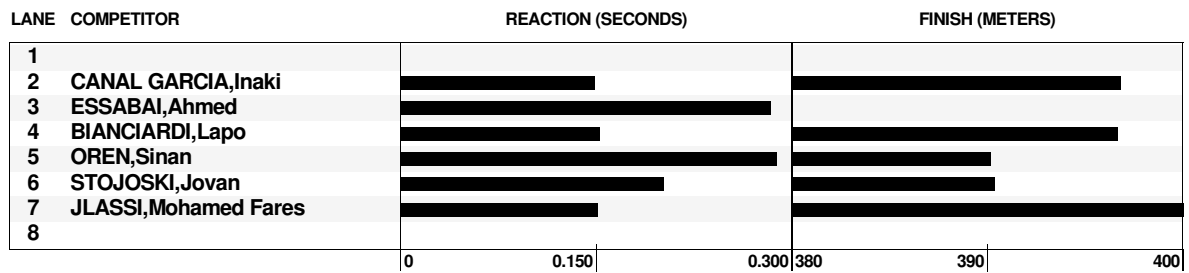

### Legend

DNF = Did Not Finish  
DQ = Disqualified  
R.T. = Reaction  
DNS = Did Not Start  
Fn = False Start

Oran 30 Juin - 3 Juillet

ATHM400M-----RND1000100--\_73A 1.0 Data Processing and Timing by Microplus - www.microplustiming.com

1



## RESULTS

RANK	BIB	SURNAME & NAME	NOC	DATE OF BIRTH	LANE	R.T.	TIME
WR	43.03	VAN NIEKERK Wayde	1992	RSA	RIO DE JANEI		14 AUG 2016
CR	45.26	RE Davide	2018	ITA	Tarragona		28 JUN 2018

### As of 01/07/2022 at 18:30

1	335	DAIR Hamza	MAR	01 OCT 2002	6	0.192	46.29 Q
2	44	HAMMOUNI Anas Es Saddik	ALG	10 NOV 1995	4	0.168	46.65 Q
3	296	LEONARDI Giuseppe	ITA	31 JUL 1996	5	0.174	47.01
4	469	KAYA Oguzhan	TUR	04 APR 2001	2	0.162	47.43
5	425	BALTI Rami	TUN	08 JAN 2001	7	0.203	47.76
6	79	RUZIC Mateo	CRO	16 AUG 1994	3	0.174	47.79

Qualification: First 2 in each heat (Q) and 2 fastest (q) to Final

Details: Start time:18:27 Temperature:+26°C Humidity:75%

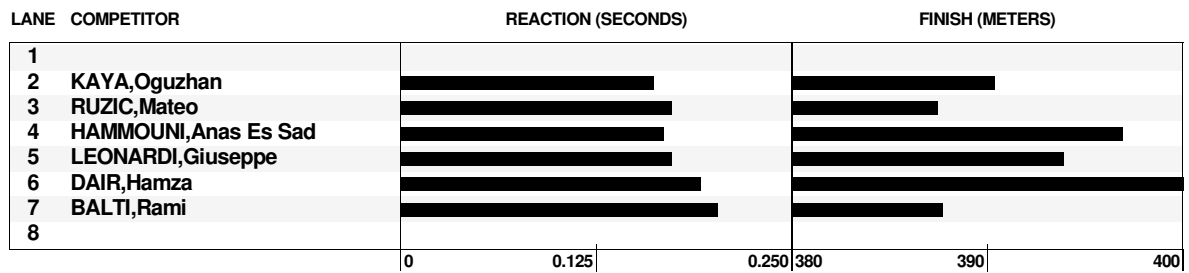

### Legend

DNF = Did Not Finish  
DQ = Disqualified  
R.T. = Reaction  
DNS = Did Not Start  
Fn = False Start

Oran 30 Juin - 3 Juillet

ATHM400M-----RND1000100--\_73A 1.0 Data Processing and Timing by Microplus - www.microplustiming.com

2



## RESULTS

RANK	BIB	SURNAME & NAME	NOC	DATE OF BIRTH	LANE	R.T.	TIME
WR	43.03	VAN NIEKERK Wayde	1992	RSA	RIO DE JANEI		14 AUG 2016
CR	45.26	RE Davide	2018	ITA	Tarragona		28 JUN 2018

### As of 01/07/2022 at 18:36

RANK	BIB	SURNAME & NAME	NOC	DATE OF BIRTH	LANE	R.T.	TIME
1	380	AGOSTINHO COELHO Joao	POR	04 APR 1999	3	0.188	45.53 Q
2	2	BURRAJ Franko	ALB	19 AUG 1998	5	0.211	46.26 Q
3	32	BENDJEMAA Abdennour	ALG	22 MAY 1994	4	0.193	46.33 q
4	210	NALIALI Christopher	FRA	08 MAR 1992	7	0.162	46.56
5	344	M'HAMDI Rachid	MAR	02 MAR 2000	6	0.195	46.59

### NOT RANKED

81	VUKOVIC Jakob	CRO	13 FEB 2001	8			DNS
----	---------------	-----	-------------	---	--	--	-----

Qualification: First 2 in each heat (Q) and 2 fastest (q) to Final

Details: Start time:18:34 Temperature:+26°C Humidity:75%

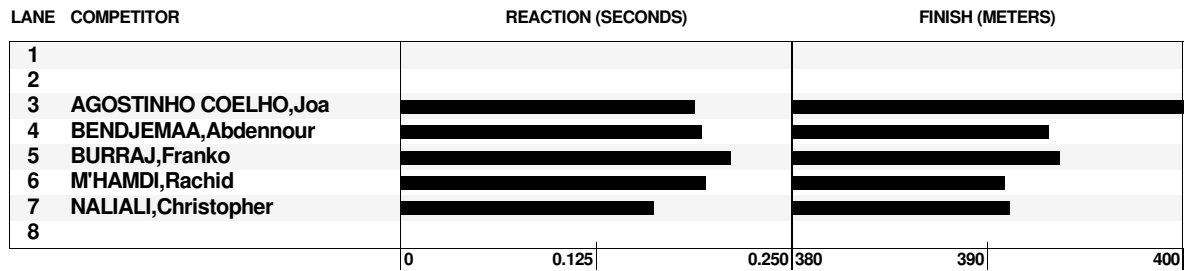

#### Legend

DNF = Did Not Finish  
DQ = Disqualified  
R.T. = Reaction  
DNS = Did Not Start  
Fn = False Start





### SUMMARY

RANK	BIB	SURNAME & NAME	NOC	DATE OF BIRTH	HEAT	LANE	RANK	WIND	TIME
WR	43.03	VAN NIEKERK Wayde	1992	RSA	RIO DE JANEI				14 AUG 2016
CR	45.26	RE Davide	2018	ITA	Tarragona				28 JUN 2018
1	380	AGOSTINHO COELHO Joao	POR	04 APR 1999	3	3	1		45.53 Q
2	430	JLASSI Mohamed Fares	TUN	09 JAN 1997	1	7	1		45.94 Q
3	2	BURRAJ Franko	ALB	19 AUG 1998	3	5	2		46.26 Q
4	335	DAIR Hamza	MAR	01 OCT 2002	2	6	1		46.29 Q
5	134	CANAL GARCIA Inaki	ESP	30 SEP 1997	1	2	2		46.31 Q
6	280	BIANCIARDI Lapo	ITA	06 JUL 1998	1	4	3		46.33 q
7	32	BENDJEMAA Abdennour	ALG	22 MAY 1994	3	4	3		46.33 q
8	210	NALIALI Christopher	FRA	08 MAR 1992	3	7	4		46.56
9	344	M'HAMDI Rachid	MAR	02 MAR 2000	3	6	5		46.59
10	44	HAMMOUNI Anas Es Saddik	ALG	10 NOV 1995	2	4	2		46.65 Q
11	296	LEONARDI Giuseppe	ITA	31 JUL 1996	2	5	3		47.01
12	353	STOJOSKI Jovan	MKD	26 NOV 1997	1	6	4		47.07
13	462	OREN Sinan	TUR	10 FEB 1998	1	5	5		47.10
14	469	KAYA Oguzhan	TUR	04 APR 2001	2	2	4		47.43
15	425	BALTI Rami	TUN	08 JAN 2001	2	7	5		47.76
16	79	RUZIC Mateo	CRO	16 AUG 1994	2	3	6		47.79
17	318	ESSABAI Ahmed	LBA	25 JUN 2000	1	3	6		52.49

### NOT RANKED

81	VUKOVIC Jakov	CRO	13 FEB 2001	3	8				DNS
----	---------------	-----	-------------	---	---	--	--	--	-----

Qualification: First 2 in each heat (Q) and 2 fastest (q) to Final

#### Legend

DNF = Did Not Finish  
DQ = Disqualified  
R.T. = Reaction

DNS = Did Not Start  
Fn = False Start

Oran 30 Juin - 3 Juillet

ATHM400M-----RND1-----\_74A 1.0 Data Processing and Timing by Microplus - www.microplustiming.com

1



## RESULTS

RANK	BIB	SURNAME & NAME	NOC	DATE OF BIRTH	LANE	R.T.	TIME
WR	1:40.91	RUDISHA David	1988	KEN	LONDON		09 AUG 2012
CR	1:44.00	OZBILEN Ilham Tanui	2013	TUR	Mersin		29 JUN 2013

### As of 03/07/2022 at 18:38

1	56	SEDJATI Djamel	ALG	03 MAY 1999	5		1:44.52
2	45	HETHAT Yassine	ALG	30 AUG 1991	6		1:44.79
3	310	TECUCEANU Catalin	ITA	09 SEP 1999	4		1:44.97 SB
4	424	AYOUNI Abdessalem	TUN	16 MAY 1994	8		1:44.99 SB
5	426	CHNINNI Riadh	TUN	15 MAR 1997	1		1:45.46 PB
6	277	BARONTINI Simone	ITA	05 JAN 1999	2		1:45.92 PB
7	336	EL GUESSE Abdelati	MAR	27 FEB 1993	3		1:46.28
8	386	MARQUES PINTO Josu Carlo	POR	03 MAY 1997	7		1:46.73

### Intermediate point leaders (Bib and Time):

400 m : 56 50.93

### Details:

Start time:18:35

Temperature:+26°C

Humidity:75%

LANE	COMPETITOR	REACTION (SECONDS)	FINISH (METERS)
1	CHNINNI,Riadh		
2	BARONTINI,Simone		
3	EL GUESSE,Abdelati		
4	TECUCEANU,Catalin		
5	SEDJATI,Djamel		
6	HETHAT,Yassine		
7	MARQUES PINTO,Josu C		
8	AYOUNI,Abdessalem		

### Legend

DNF = Did Not Finish  
DQ = Disqualified  
PB = Personal Best  
SB = Season's Best

DNS = Did Not Start  
Fn = False Start  
R.T. = Reaction

Oran 30 Juin - 3 Juillet

ATHM800M-----FNL-000100--\_73A 1.0 Data Processing and Timing by Microplus - www.microplustiming.com

1



## RESULTS

RANK	BIB	SURNAME & NAME	NOC	DATE OF BIRTH	LANE	R.T.	TIME
WR	1:40.91	RUDISHA David	1988	KEN	LONDON		09 AUG 2012
CR	1:44.00	OZBILEN Ilham Tanui	2013	TUR	Mersin		29 JUN 2013

### As of 01/07/2022 at 18:49

RANK	BIB	SURNAME & NAME	NOC	DATE OF BIRTH	LANE	R.T.	TIME
1	310	TECUCEANU Catalin	ITA	09 SEP 1999	4		1:47.10 Q
2	424	AYOUNI Abdessalem	TUN	16 MAY 1994	6		1:47.18 Q
3	70	MUJEZINOVIC Abedin	BIH	02 JUN 1993	3		1:47.23
4	348	SMAILI Mostafa	MAR	09 JAN 1997	2		1:47.80
5	225	KOTITSAS Christos	GRE	06 OCT 1996	7		1:48.03
6	203	LE MEUR Ludovic	FRA	24 JUN 1998	8		1:48.79
7	97	DIMITRIOU Christos	CYP	22 SEP 1993	5		1:51.18

Qualification: First 2 in each heat (Q) and 2 fastest (q) to Final

Intermediate point leaders (Bib and Time):

Details:

Start time:18:45

Temperature:+27°C

LANE	COMPETITOR	REACTION (SECONDS)	FINISH (METERS)
1			
2	SMAILI, Mostafa		
3	MUJEZINOVIC, Abedin		
4	TECUCEANU, Catalin		
5	DIMITRIOU, Christos		
6	AYOUNI, Abdessalem		
7	KOTITSAS, Christos		
8	LE MEUR, Ludovic		

### Legend

DNF = Did Not Finish  
DQ = Disqualified  
R.T. = Reaction

DNS = Did Not Start  
Fn = False Start

Oran 30 Juin - 3 Juillet

ATHM800M-----RND1000100--\_73A 1.0 Data Processing and Timing by Microplus - www.microplustiming.com

1



## RESULTS

RANK BIB SURNAME & NAME NOC DATE OF BIRTH LANE R.T. TIME

WR	1:40.91	RUDISHA David	1988	KEN	LONDON	09 AUG 2012
CR	1:44.00	OZBILEN Ilham Tanui	2013	TUR	Mersin	29 JUN 2013

### As of 01/07/2022 at 18:55

1	56	SEDJATI Djamel	ALG	03 MAY 1999	4	1:46.39	Q
2	336	EL GUESSE Abdelati	MAR	27 FEB 1993	2	1:46.57	Q
3	277	BARONTINI Simone	ITA	05 JAN 1999	5	1:46.89	q
4	426	CHNINNI Riadh	TUN	15 MAR 1997	3	1:47.00	q
5	140	GUERRERO CASCON Alberto	ESP	04 APR 1995	7	1:47.82	
6	237	XENIDAKIS Charidimos	GRE	08 FEB 2000	8	1:48.83	
7	360	MICALLEF Benjamin Andrew	MLT	27 JAN 1999	6	1:58.18	

Qualification: First 2 in each heat (Q) and 2 fastest (q) to Final

Intermediate point leaders (Bib and Time):

400 m : 237 53.57

Details:

Start time:18:52

Temperature:+26°C

Humidity:75%

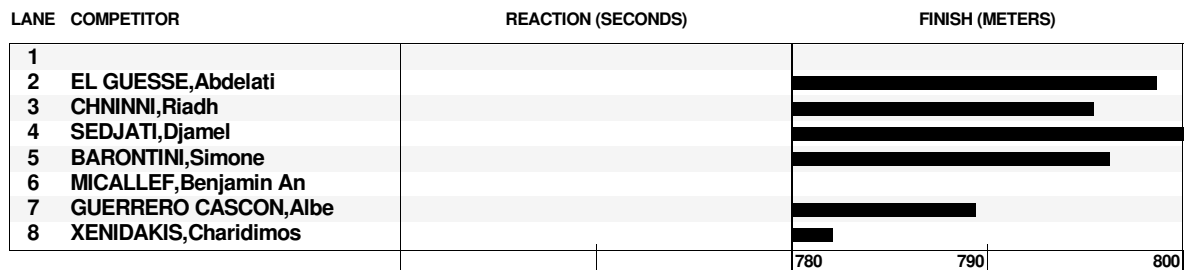

### Legend

DNF = Did Not Finish  
DQ = Disqualified  
R.T. = Reaction

DNS = Did Not Start  
Fn = False Start

Oran 30 Juin - 3 Juillet

ATHM800M-----RND1000100--\_73A 1.0 Data Processing and Timing by Microplus - www.microplustiming.com

2



## RESULTS

RANK BIB SURNAME & NAME NOC DATE OF BIRTH LANE R.T. TIME

WR	1:40.91	RUDISHA David	1988	KEN	LONDON	09 AUG 2012
CR	1:44.00	OZBILEN Ilham Tanui	2013	TUR	Mersin	29 JUN 2013

### As of 01/07/2022 at 19:02

RANK	BIB	SURNAME & NAME	NOC	DATE OF BIRTH	LANE	R.T.	TIME
1	45	HETHAT Yassine	ALG	30 AUG 1991	8		1:49.05 Q
2	386	MARQUES PINTO Josu Carlo	POR	03 MAY 1997	4		1:49.31 Q
3	65	MOYA BETRIU Pol	AND	09 DEC 1996	2		1:49.39
4	468	TOKSOZ Salih	TUR	01 JAN 1994	6		1:50.05
5	312	KRYEZIU Astrit	KOS	22 OCT 1991	5		1:50.57
6	191	CULTRU Sacha	FRA	05 JAN 1999	3		1:51.50
7	80	VIDEKA Karlo	CRO	25 APR 2000	7		1:52.17

Qualification: First 2 in each heat (Q) and 2 fastest (q) to Final

Intermediate point leaders (Bib and Time):

400 m : 65 55.95

Details: Start time:18:59 Temperature:+26°C Humidity:75%

LANE	COMPETITOR	REACTION (SECONDS)	FINISH (METERS)
1	MOYA BETRIU,Pol		
2	CULTRU,Sacha		
3	MARQUES PINTO,Josu C		
4	KRYEZIU,Astrit		
5	TOKSOZ,Salih		
6	VIDEKA,Karlo		
7	HETHAT,Yassine		
8			

### Legend

DNF = Did Not Finish  
DQ = Disqualified  
R.T. = Reaction

DNS = Did Not Start  
Fn = False Start

Oran 30 Juin - 3 Juillet

ATHM800M-----RND1000100--\_73A 1.0 Data Processing and Timing by Microplus - www.microplustiming.com

3



## SUMMARY

RANK	BIB	SURNAME & NAME	NOC	DATE OF BIRTH	HEAT	LANE	RANK	WIND	TIME
WR	1:40.91	RUDISHA David	1988	KEN	LONDON				09 AUG 2012
CR	1:44.00	OZBILEN Ilham Tanui	2013	TUR	Mersin				29 JUN 2013
1	56	SEDJATI Djamel	ALG	03 MAY 1999	2	4	1		1:46.39 Q
2	336	EL GUESSE Abdelati	MAR	27 FEB 1993	2	2	2		1:46.57 Q
3	277	BARONTINI Simone	ITA	05 JAN 1999	2	5	3		1:46.89 q
4	426	CHNINI Riadh	TUN	15 MAR 1997	2	3	4		1:47.00 q
5	310	TECUCEANU Catalin	ITA	09 SEP 1999	1	4	1		1:47.10 Q
6	424	AYOUNI Abdessalem	TUN	16 MAY 1994	1	6	2		1:47.18 Q
7	70	MUJEZINOVIC Abedin	BIH	02 JUN 1993	1	3	3		1:47.23
8	348	SMAILI Mostafa	MAR	09 JAN 1997	1	2	4		1:47.80
9	140	GUERRERO CASCON Alberto	ESP	04 APR 1995	2	7	5		1:47.82
10	225	KOTITSAS Christos	GRE	06 OCT 1996	1	7	5		1:48.03
11	203	LE MEUR Ludovic	FRA	24 JUN 1998	1	8	6		1:48.79
12	237	XENIDAKIS Charidimos	GRE	08 FEB 2000	2	8	6		1:48.83
13	45	HETHAT Yassine	ALG	30 AUG 1991	3	8	1		1:49.05 Q
14	386	MARQUES PINTO Josu Carlo	POR	03 MAY 1997	3	4	2		1:49.31 Q
15	65	MOYA BETRIU Pol	AND	09 DEC 1996	3	2	3		1:49.39
16	468	TOKSOZ Salih	TUR	01 JAN 1994	3	6	4		1:50.05
17	312	KRYEZIU Astrit	KOS	22 OCT 1991	3	5	5		1:50.57
18	97	DIMITRIOU Christos	CYP	22 SEP 1993	1	5	7		1:51.18
19	191	CULTRU Sacha	FRA	05 JAN 1999	3	3	6		1:51.50
20	80	VIDEKA Karlo	CRO	25 APR 2000	3	7	7		1:52.17
21	360	MICALLEF Benjamin Andrew	MLT	27 JAN 1999	2	6	7		1:58.18

Qualification: First 2 in each heat (Q) and 2 fastest (q) to Final

### Legend

DNF = Did Not Finish  
DQ = Disqualified  
R.T. = Reaction

DNS = Did Not Start  
Fn = False Start



## RESULTS

RANK	BIB	SURNAME & NAME	NOC	DATE OF BIRTH	ORD	TIME
WR	3:26.00	EL GUERROUJ Hicham	1974	MAR	ROMA	14 JUL 1998
CR	3:29.20	MORCELI Nouredine	1993	ALG	Narbonne	20 JUN 1993

### As of 02/07/2022 at 20:57

1	195	HABZ Azeddine	FRA	1993	10	3:41.65	
2	347	SADIKI Abdellatif	MAR	1999	9	3:42.00	
3	300	MESLEK Ossama	ITA	1997	2	3:42.49	
4	276	ARESE Pietro	ITA	1999	16	3:42.80	
5	65	MOYA BETRIU Pol	AND	1996	11	3:43.58	
6	426	CHNINI Riadh	TUN	1997	3	3:43.64	
7	47	KEDDAR Salim	ALG	1993	6	3:44.18	
8	40	DRABLI Mohamed-amine	ALG		15	3:45.14	
9	137	EL KHAYAMI EL KOMIRY Abd	ESP	1995	13	3:45.25	
10	418	BIBIC Elzan	SRB	1999	12	3:45.42	
11	67	CUKOVIC Stefan	BIH	1997	14	3:50.33	
12	64	CARABAĀ VALENZUELA Nahu	AND	1999	1	3:51.89	
13	453	BARBAROS Ramazan	TUR	1998	5	3:53.55	
14	315	ALGORNI Alaa	LBA	1994	4	3:53.88	PB

### NOT RANKED

240	RANC Julian	FRA	1996	7	DNS
345	MOUJAHID El Hassane	MAR		8	DNF
424	AYOUNI Abdessalem	TUN	1994	17	DQ TR 17.3.2

### Intermediate point leaders (Bib and Time):

400 m :	453	1:00.85
800 m :	453	2:05.06
1200 m :	195	3:02.42

Details: Start time:20:25 Temperature:+25°C Humidity:75%

### Legend

* = Caution	DNF = Did Not Finish
DNS = Did Not Start	DQ = Disqualified
ORD = Order	PB = Personal Best

Oran 30 Juin - 3 Juillet

ATHM1500M-----FNL-000100--\_73G 1.0 Data Processing and Timing by Microplus - www.microplustiming.com

1



## RESULTS

RANK	BIB	SURNAME & NAME	NOC	DATE OF BIRTH	ORD	TIME
WR	12:35.36	CHEPTEGEI Joshua	1996	UGA	MONACO	14 AUG 2020
CR	13:25.29	GARCIA Alberto	1997	ESP	Bari	17 JUN 1997

### As of 03/07/2022 at 19:54

1	334	BOUQANTAR Soufiyan	MAR	1993	12	13:36.12	
2	337	FARES Mohamed	MAR	1991	3	13:36.85	
3	306	QUAZZOLA Italo	ITA	1994	11	13:37.63	PB
4	459	KAYA Aras	TUR	1994	9	13:44.67	
5	391	VILA BARATA Samuel	POR	1993	2	13:47.09	
6	52	MERBOUHI Mohammed	ALG	1991	13	13:49.54	
7	43	GRINE Ali	ALG	1990	1	13:54.35	
8	352	IVANOVSKI Dario	MKD	1997	8	13:54.58	PB
9	285	DE CARO Dario	ITA	1997	4	13:56.63	
10	222	ANAGNOSTOU Marios	GRE	1999	14	14:17.20	SB
11	194	FREERE Mehdi	FRA	1996	10	14:40.13	
12	183	BEDARD Simon	FRA	1997	6	14:51.20	

### NOT RANKED

427	JAZIRI Ahmed	TUN	1997	7	DNS
453	BARBAROS Ramazan	TUR	1998	5	DNF

### Intermediate point leaders (Bib and Time):

3000 m :	459	8:16.48
4000 m :	337	11:01.40

Details: Start time:19:35 Temperature:+25°C Humidity:80%

### Legend

* = Caution	DNF = Did Not Finish
DNS = Did Not Start	DQ = Disqualified
ORD = Order	PB = Personal Best
SB = Season's Best	

Oran 30 Juin - 3 Juillet

ATHM5000M-----FNL-000100--\_73G 1.0 Data Processing and Timing by Microplus - www.microplustiming.com

1





## RESULTS

RANK	BIB	SURNAME & NAME	NOC	DATE OF BIRTH	ORD	TIME
WR	57:31	KIPLIMO Jacob	2000	UGA	LISBOA	21 NOV 2021
CR	1:04:03	EL AARABY Mohamed Reda	2018	MAR	Tarragona	30 JUN 2018

### As of 01/07/2022 at 9:49

1	346	OUTALHA Mohcin	MAR	15 DEC 1998	8	1:04:05
2	188	CHOQUERT Benjamin	FRA	17 APR 1986	13	1:04:19
3	334	BOUQANTAR Soufiyan	MAR	30 AUG 1993	1	1:04:57
4	451	ATAC Sezgin	TUR	21 MAR 1998	5	1:05:02
5	99	KHADIRI Amine	CYP	20 NOV 1988	4	1:06:18
6	41	EL HANNACHI Nabil	ALG	17 JAN 1996	6	1:07:06
7	49	LAAMEUCH El Hadi	ALG	05 MAR 1990	11	1:07:24
8	200	KOWAL Yoann	FRA	28 MAY 1987	3	1:09:34
9	202	LE DEAN Geoffrey	FRA	20 JAN 1988	7	1:10:31
10	358	CASSAR Dillon	MLT	01 MAR 1997	12	1:14:41

### NOT RANKED

29	ABOUD Rabah	ALG	01 JAN 1981	9	DNF
431	SAAD Atef	TUN	20 MAR 1988	2	DNF
463	OZDEMIR Ramazan	TUR	06 JUL 1991	10	DNF

### Intermediate point leaders (Bib and Time):

Details: Start time: 8:00 Temperature: +24°C Humidity: 74%

### Legend

* = Caution	DNF = Did Not Finish
DNS = Did Not Start	DQ = Disqualified
ORD = Order	

Oran 30 Juin - 3 Juillet

ATHMMARATHON-----FNL-000100--\_73K Data Processing and Timing by Microplus - www.microplustiming.com

1



## RESULTS

RANK	BIB	SURNAME & NAME	NOC	DATE OF BIRTH	ORD	TIME
WR	7:53.63	SHAHEEN Saif Saaeed	1982	QAT	BRUXELLES	03 SEP 2004
CR	8:13.11	CHATBI Jamel	2009	MAR	Pescara	02 JUL 2009

### As of 30/06/2022 at 20:07

1	58	TABTI Bilal	ALG	1993	5	8:22.79
2	349	TINDOUFT Mohamed	MAR	1993	9	8:23.85
3	34	BOUCHICHA Hichem	ALG	1989	10	8:23.95
4	427	JAZIRI Ahmed	TUN	1997	6	8:24.31
5	333	BOUASSEL Abderrafia	MAR	2001	3	8:29.59
6	470	YEGO Hilal	TUR	1992	12	8:33.43
7	180	AIRIAU Gatien	FRA	1993	4	8:34.12
8	428	JHINAOUI Mohamed Amin	TUN	1997	8	8:35.32
9	146	QUIJADA SANCHEZ Alejandr	ESP	2001	7	8:36.69
10	387	MENDES BARROS Etson	POR	2001	2	8:37.57
11	293	GATTO Giovanni	ITA	1999	13	8:46.77
12	193	DUIGOU Clement	FRA	1996	11	8:52.68

### NOT RANKED

233	STAMOULIS Georgios	GRE	1998	1	DNF
-----	--------------------	-----	------	---	-----

#### Intermediate point leaders (Bib and Time):

1000 m :	470	2:50.30
2000 m :	470	5:44.90

Details: Start time:19:52 Temperature:+23°C Humidity:80%

#### Legend

* = Caution	DNF = Did Not Finish
DNS = Did Not Start	DQ = Disqualified
ORD = Order	

Oran 30 Juin - 3 Juillet

ATHM3000MST-----FNL-000100--\_73G 1.0Data Processing and Timing by Microplus - www.microplustiming.com

1



## RESULTS

RANK BIB SURNAME & NAME NOC DATE OF BIRTH LANE R.T. TIME

WR	12.80	MERRITT Aries	1985	USA	BRUXELLES	07 SEP 2012
CR	13.45	DOUVALIDIS Konstadinos	2013	GRE	Mersin	26 JUN 2013

As of 03/07/2022 at 19:07

(Wind: +0.3 m/s)

1	108	TRAJKOVIC Milan	CYP	17 MAR 1992	3	0.165	<b>13.34</b>	CR
2	33	BOUANANI Amine	ALG	17 OCT 1997	4	0.166	<b>13.38</b>	PB
3	142	LLOPIS DOMENECH Enrique	ESP	15 OCT 2000	6	0.140	<b>13.47</b>	SB
4	467	SEVLER Mikdat	TUR	21 JAN 1998	5	0.152	<b>13.57</b>	
5	309	SIMONELLI Lorenzo Ndele	ITA	01 JUN 2002	1	0.152	<b>13.59</b>	
6	398	DEMSAR Filip Jakob	SLO	03 APR 2000	7	0.165	<b>13.72</b>	
7	136	CISNEROS ALBA Daniel	ESP	02 JUN 1996	8	0.160	<b>13.98</b>	
8	291	FERRANTE Francesco	ITA	13 MAY 1996	2	0.158	<b>14.27</b>	

Details:

Start time:19:05

Temperature:+26°C

Humidity:75%



### Legend

CR = Championship Record  
DNS = Did Not Start  
Fn = False Start  
R.T. = Reaction

DNF = Did Not Finish  
DQ = Disqualified  
PB = Personal Best  
SB = Season's Best

Oran 30 Juin - 3 Juillet

ATHM110MHURD-----FNL-000100--\_73A 1@Data Processing and Timing by Microplus - www.microplustiming.com

1



## RESULTS

RANK	BIB	SURNAME & NAME	NOC	DATE OF BIRTH	LANE	R.T.	TIME
WR	12.80	MERRITT Aries	USA	1985	BRUXELLES		07 SEP 2012
CR	13.45	DOUVALIDIS Konstadinos	GRE	2013	Mersin		26 JUN 2013

As of 02/07/2022 at 18:01

(Wind: +0.7 m/s)

RANK	BIB	SURNAME & NAME	NOC	DATE OF BIRTH	LANE	R.T.	TIME	MARKS
1	108	TRAJKOVIC Milan	CYP	17 MAR 1992	6	0.163	13.32	Q SB
2	467	SEVLER Mikdat	TUR	21 JAN 1998	8	0.150	13.40	Q PB
3	136	CISNEROS ALBA Daniel	ESP	02 JUN 1996	7	0.167	13.53	Q
4	291	FERRANTE Francesco	ITA	13 MAY 1996	2	0.163	13.88	q
5	77	CUKMAN Hrvoje	CRO	28 MAY 1998	3	0.177	14.05	
6	384	LARRINAGA HERNANDEZ Abde	POR	13 JUL 1994	4	0.150	14.06	
7	362	SALIBA Daniel	MLT	23 FEB 1995	5	0.202	15.05	

Qualification: First 3 in each heat (Q) and 2 fastest (q) to Final

Details:

Start time:18:00

Temperature:+26°C

Humidity:65%

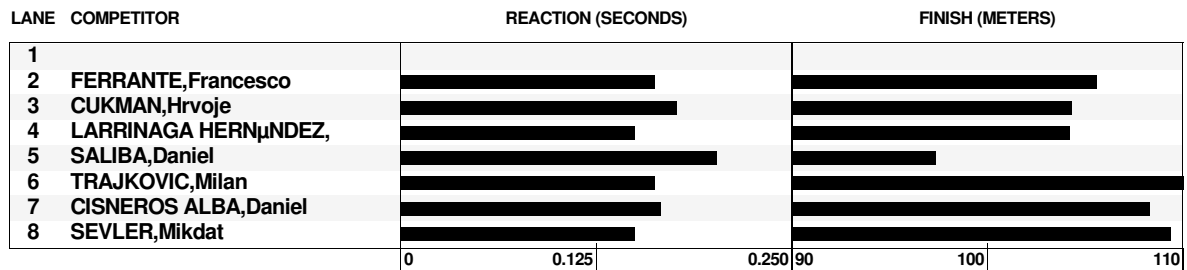

### Legend

DNF = Did Not Finish  
DQ = Disqualified  
PB = Personal Best  
SB = Season's Best

DNS = Did Not Start  
Fn = False Start  
R.T. = Reaction

Oran 30 Juin - 3 Juillet

ATHM110MHURD-----RND1000100--\_73A Data Processing and Timing by Microplus - www.microplustiming.com

1



## RESULTS

RANK BIB SURNAME & NAME NOC DATE OF BIRTH LANE R.T. TIME

WR	12.80	MERRITT Aries	1985	USA	BRUXELLES	07 SEP 2012
CR	13.45	DOUVALIDIS Konstadinos	2013	GRE	Mersin	26 JUN 2013

As of 02/07/2022 at 18:09

(Wind: -0.4 m/s)

1	33	BOUANANI Amine	ALG	17 OCT 1997	6	0.191	13.44	Q	PB
2	142	LLOPIS DOMENECH Enrique	ESP	15 OCT 2000	8	0.144	13.52	Q	
3	398	DEMSAR Filip Jakob	SLO	03 APR 2000	5	0.153	13.65	Q	PB
4	309	SIMONELLI Lorenzo Ndele	ITA	01 JUN 2002	7	0.144	13.72	q	
5	382	DE OLIVEIRA JoJo Vitor	POR	15 MAY 1992	2	0.179	13.92		
6	120	RAMADAN Youssef	EGY	07 FEB 2002	4	0.129	14.19		

### NOT RANKED

208 MOHAMED Raphael FRA 02 FEB 1998 3 DNS

Qualification: First 3 in each heat (Q) and 2 fastest (q) to Final

Details: Start time:18:07 Temperature:+26°C Humidity:65%

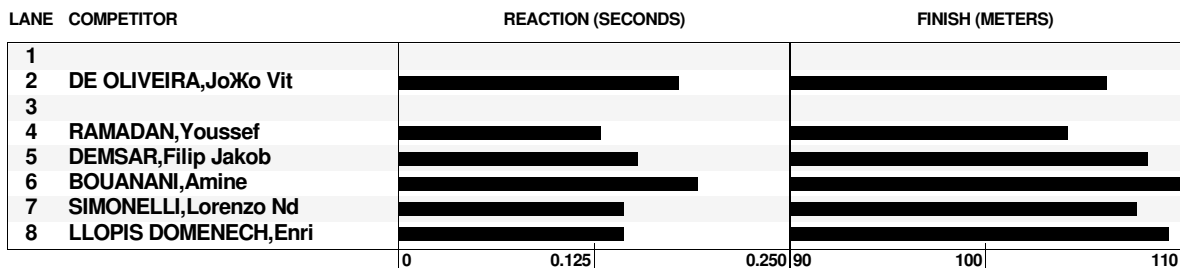

### Legend

DNF = Did Not Finish  
DQ = Disqualified  
PB = Personal Best  
SB = Season's Best  
DNS = Did Not Start  
Fn = False Start  
R.T. = Reaction

Oran 30 Juin - 3 Juillet

ATHM110MHURD-----RND1000100--\_73A Data Processing and Timing by Microplus - www.microplustiming.com

2



## SUMMARY

RANK	BIB	SURNAME & NAME	NOC	DATE OF BIRTH	HEAT	LANE	RANK	WIND	TIME		
WR	12.80	MERRITT Aries	USA	1985	BRUXELLES						07 SEP 2012
CR	13.45	DOUVALIDIS Konstadinos	GRE	2013	Mersin						26 JUN 2013
1	108	TRAJKOVIC Milan	CYP	17 MAR 1992	1	6	1	+0.7	<b>13.32</b>	Q	SB
2	467	SEVLER Mikdat	TUR	21 JAN 1998	1	8	2	+0.7	<b>13.40</b>	Q	PB
3	33	BOUANANI Amine	ALG	17 OCT 1997	2	6	1	-0.4	<b>13.44</b>	Q	PB
4	142	LLOPIS DOMENECH Enrique	ESP	15 OCT 2000	2	8	2	-0.4	<b>13.52</b>	Q	
5	136	CISNEROS ALBA Daniel	ESP	02 JUN 1996	1	7	3	+0.7	<b>13.53</b>	Q	
6	398	DEMSAR Filip Jakob	SLO	03 APR 2000	2	5	3	-0.4	<b>13.65</b>	Q	PB
7	309	SIMONELLI Lorenzo Ndele	ITA	01 JUN 2002	2	7	4	-0.4	<b>13.72</b>	q	
8	291	FERRANTE Francesco	ITA	13 MAY 1996	1	2	4	+0.7	<b>13.88</b>	q	
9	382	DE OLIVEIRA JoJo Vitor	POR	15 MAY 1992	2	2	5	-0.4	<b>13.92</b>		
10	77	CUKMAN Hrvoje	CRO	28 MAY 1998	1	3	5	+0.7	<b>14.05</b>		
11	384	LARRINAGA HERNANDEZ Abde	POR	13 JUL 1994	1	4	6	+0.7	<b>14.06</b>		
12	120	RAMADAN Youssef	EGY	07 FEB 2002	2	4	6	-0.4	<b>14.19</b>		
13	362	SALIBA Daniel	MLT	23 FEB 1995	1	5	7	+0.7	<b>15.05</b>		

## NOT RANKED

208	MOHAMED Raphael	FRA	02 FEB 1998	2	3			-0.4	<b>DNS</b>		
-----	-----------------	-----	-------------	---	---	--	--	------	------------	--	--

Qualification: First 3 in each heat (Q) and 2 fastest (q) to Final

### Legend

DNF = Did Not Finish  
DQ = Disqualified  
PB = Personal Best  
SB = Season's Best

DNS = Did Not Start  
Fn = False Start  
R.T. = Reaction

Oran 30 Juin - 3 Juillet

ATHM110MHURD-----RND1-----\_74A 1.0Data Processing and Timing by Microplus - www.microplustiming.com

1



## RESULTS

RANK	BIB	SURNAME & NAME	NOC	DATE OF BIRTH	LANE	R.T.	TIME
WR	45.94	WARHOLM Karsten	1996	NOR	TOKYO		03 AUG 2021
CR	48.76	VAILLANT Ludvy	2018	FRA	TARRAGONA		29 JUN 2018

### As of 01/07/2022 at 19:39

RANK	BIB	SURNAME & NAME	NOC	DATE OF BIRTH	LANE	R.T.	TIME	STATUS
1	456	ESCOBAR Yasmani Copello	TUR	15 APR 1987	5	0.167	48.27	SB
2	213	VAILLANT Ludvy	FRA	15 MAR 1995	3	0.186	48.83	SB
3	50	LAHOULOU Abdelmalik	ALG	07 MAY 1992	8	0.185	48.87	SB
4	278	BENCOSME DE LEON Jose' R	ITA	16 MAY 1992	6	0.164	48.91	PB
5	295	LAMBRUGHI Mario	ITA	05 FEB 1992	2	0.173	49.29	
6	36	BOUKMOUCHE Saber	ALG	20 APR 1992	7	0.592	50.01	
7	460	NEZIR Ismail	TUR	22 JAN 2003	4	0.207	50.09	PB
8	432	TOUATI Mohamed Amine	TUN	09 SEP 1998	1	0.166	50.13	SB

Details: Start time:19:15 Temperature:+26°C Humidity:80%

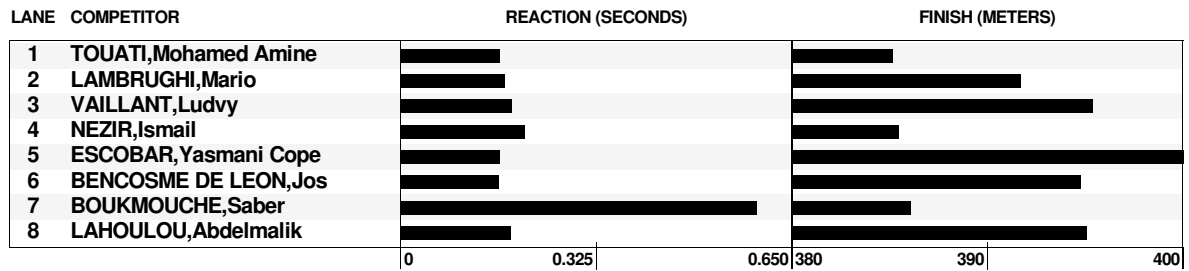

### Legend

DNF = Did Not Finish	DNS = Did Not Start
DQ = Disqualified	Fn = False Start
PB = Personal Best	R.T. = Reaction
SB = Season's Best	

Oran 30 Juin - 3 Juillet

ATHM400MHURD-----FNL-000100--\_73A 1 Data Processing and Timing by Microplus - www.microplustiming.com

1



Complexe Olympique - Grand Stade  
Athletic  
Men's 400 m Hurdles - 1st Round  
Heat 1 of 2



RESULTS

RANK	BIB	SURNAME & NAME	NOC	DATE OF BIRTH	LANE	R.T.	TIME
WR	45.94	WARHOLM Karsten	1996	NOR	TOKYO		03 AUG 2021
CR	48.76	VAILLANT Ludvy	2018	FRA	TARRAGONA		29 JUN 2018

As of 30/06/2022 at 18:07

1	278	BENCOSME DE LEON Jose' R	ITA	16 MAY 1992	8	0.186	49.55 Q
2	460	NEZIR Ismail	TUR	22 JAN 2003	6	0.205	49.59 Q
3	36	BOUKMOUCHE Saber	ALG	20 APR 1992	7	0.346	50.38 Q
4	432	TOUATI Mohamed Amine	TUN	09 SEP 1998	4	0.199	50.55 q
5	342	MANYANI Ismail	MAR	28 MAY 2000	2	0.172	51.45
6	145	PORRAS CANTONS Aleix Sal	ESP	09 NOV 1999	3	0.184	51.90

NOT RANKED

340	HINTI Saad	MAR	27 APR 2002	5		DNS
-----	------------	-----	-------------	---	--	-----

Qualification: First 3 in each heat (Q) and 2 fastest (q) to Final

Details: Start time:18:00 Temperature:+25°C Humidity:80%

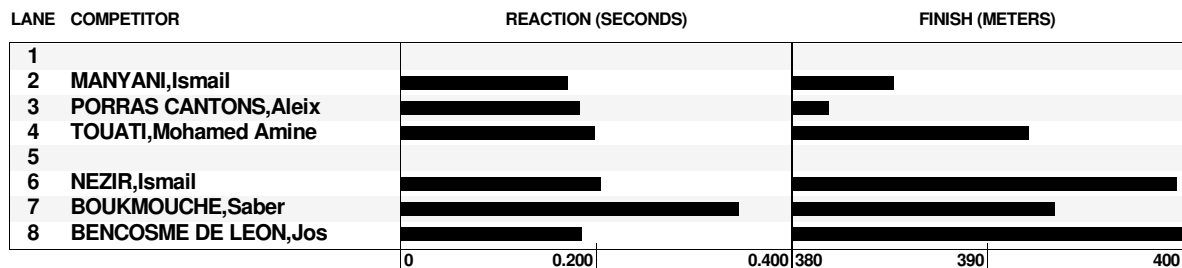

Legend

DNF = Did Not Finish	DNS = Did Not Start
DQ = Disqualified	Fn = False Start
R.T. = Reaction	

Oran 30 Juin - 3 Juillet

ATHM400MHURD-----RND1000100--\_73A Data Processing and Timing by Microplus - www.microplustiming.com

1





## RESULTS

RANK	BIB	SURNAME & NAME	NOC	DATE OF BIRTH	LANE	R.T.	TIME
WR	45.94	WARHOLM Karsten	1996	NOR	TOKYO		03 AUG 2021
CR	48.76	VAILLANT Ludvy	2018	FRA	TARRAGONA		29 JUN 2018

### As of 30/06/2022 at 18:15

1	213	VAILLANT Ludvy	FRA	15 MAR 1995	3	0.232	49.07 Q
2	456	ESCOBAR Yasmani Copello	TUR	15 APR 1987	5	0.238	49.08 Q
3	50	LAHOULOU Abdelmalik	ALG	07 MAY 1992	4	0.262	49.30 Q
4	295	LAMBRUGHIO Mario	ITA	05 FEB 1992	8	0.164	50.32 q
5	408	ERCOLANI VOLTA Andrea	SMR	20 APR 1995	7	0.227	52.35
6	68	MALKOCEVIC Rusmir	BIH	09 JAN 1996	6	0.197	53.27

### NOT RANKED

199	KOUNTA Muhammad	FRA	27 OCT 1994	2	DNS
-----	-----------------	-----	-------------	---	-----

Qualification: First 3 in each heat (Q) and 2 fastest (q) to Final

Details: Start time:18:12 Temperature:+25°C Humidity:80%

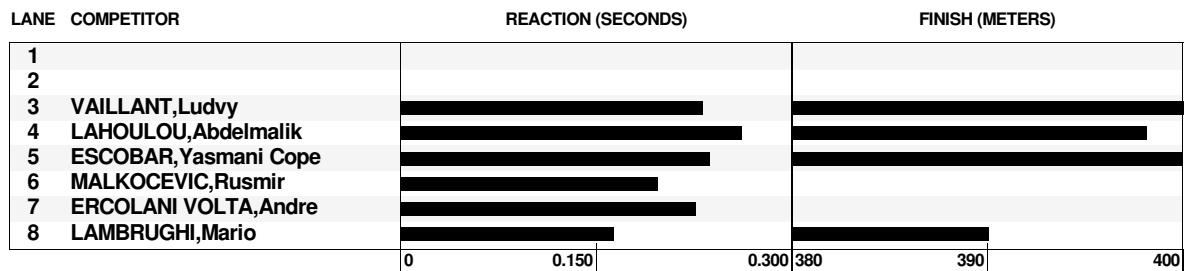

### Legend

DNF = Did Not Finish	DNS = Did Not Start
DQ = Disqualified	Fn = False Start
R.T. = Reaction	

Oran 30 Juin - 3 Juillet

ATHM400MHURD-----RND1000100--\_73A Data Processing and Timing by Microplus - www.microplustiming.com

2



## SUMMARY

RANK	BIB	SURNAME & NAME	NOC	DATE OF BIRTH	HEAT	LANE	RANK	WIND	TIME
<b>WR</b>		<b>45.94 WARHOLM Karsten</b>		1996 NOR	TOKYO				03 AUG 2021
<b>CR</b>		<b>48.76 VAILLANT Ludvy</b>		2018 FRA	TARRAGONA				29 JUN 2018
1	213	<b>VAILLANT Ludvy</b>	FRA	15 MAR 1995	2	3	1		<b>49.07</b> Q
2	456	<b>ESCOBAR Yasmani Copello</b>	TUR	15 APR 1987	2	5	2		<b>49.08</b> Q
3	50	<b>LAHOULOU Abdelmalik</b>	ALG	07 MAY 1992	2	4	3		<b>49.30</b> Q
4	278	<b>BENCOSME DE LEON Jose' R</b>	ITA	16 MAY 1992	1	8	1		<b>49.55</b> Q
5	460	<b>NEZIR Ismail</b>	TUR	22 JAN 2003	1	6	2		<b>49.59</b> Q
6	295	<b>LAMBRUGHI Mario</b>	ITA	05 FEB 1992	2	8	4		<b>50.32</b> q
7	36	<b>BOUKMOUCHE Saber</b>	ALG	20 APR 1992	1	7	3		<b>50.38</b> Q
8	432	<b>TOUATI Mohamed Amine</b>	TUN	09 SEP 1998	1	4	4		<b>50.55</b> q
9	342	<b>MANYANI Ismail</b>	MAR	28 MAY 2000	1	2	5		<b>51.45</b>
10	145	<b>PORRAS CANTONS Aleix Sal</b>	ESP	09 NOV 1999	1	3	6		<b>51.90</b>
11	408	<b>ERCOLANI VOLTA Andrea</b>	SMR	20 APR 1995	2	7	5		<b>52.35</b>
12	68	<b>MALKOCEVIC Rusmir</b>	BIH	09 JAN 1996	2	6	6		<b>53.27</b>

## NOT RANKED

199	<b>KOUNTA Muhammad</b>	FRA	27 OCT 1994	2	2			<b>DNS</b>
340	<b>HINTI Saad</b>	MAR	27 APR 2002	1	5			<b>DNS</b>

*Qualification: First 3 in each heat (Q) and 2 fastest (q) to Final*

### Legend

**DNF** = Did Not Finish  
**DQ** = Disqualified  
**R.T.** = Reaction

**DNS** = Did Not Start  
**Fn** = False Start



## RESULTS

RANK	BIB	SURNAME & NAME	NOC	DATE OF BIRTH	RESULT
WR	2.45	SOTOMAYOR Javier	1967 CUB	SALAMANCA	27 JUL 1993
CR	2.34	BANIOTIS Konstadinos	2013 GRE	Mersin	27 JUL 2013

### As of 01/07/2022 at 20:19

RANK	BIB	SURNAME & NAME	NOC	DATE OF BIRTH	RESULT	
1	30	AFER Bilel	ALG	11 FEB 2001	2.24	PB
2	422	GHAZAL Majd Eddin	SYR	21 APR 1987	2.22	
3	35	BOUHANOUNE Hichem	ALG	01 JAN 1997	2.22	PB
4	227	MERLOS Antonios	GRE	04 APR 1999	2.22	SB
5	197	ISMAR Nathan	FRA	30 MAR 1999	2.19	
5	207	MICHEAU Sebastien	FRA	03 MAY 1998	2.19	
7	289	FASSINOTTI Marco	ITA	29 APR 1989	2.19	
8	287	FALOCCHI Christian	ITA	30 JAN 1997	2.16	
9	450	ACET Alperen	TUR	02 APR 1998	2.13	
10	114	ABOUTALEB Mohamed	EGY	21 FEB 1990	2.09	
10	390	VARELA BALDE' Gerson	POR	28 JAN 2000	2.09	
12	101	PAMPAKAS Kyriakos	CYP	14 JUL 2001	2.04	

### NOT RANKED

100 KONSTANTINOOU Vasilios CYP 1992 DNS

Details: Start time:18:05 Temperature:+26°C Humidity:80%  
Finish Time:20:10 Temperature:+25°C Humidity:85%

### As of 01/07/2022 at 20:19

RANK	BIB	SURNAME & NAME	NOC	ORD	1.99	2.04	2.09	2.13	2.16	2.19	2.22	2.24	2.26	RESULT
			DATE OF BIRTH											
10	114	ABOUTALEB Mohamed	EGY	1	O	O	O	XXX						2.09
			21 FEB 1990											
3	35	BOUHANOUNE Hichem	ALG	2	-	O	O	O	O	XO	O	XXX		2.22 PB
			01 JAN 1997											
4	227	MERLOS Antonios	GRE	3	-	O	O	-	XXO	XXO	XXO	XXX		2.22 SB
			04 APR 1999											
5	207	MICHEAU Sebastien	FRA	4	-	-	O	O	O	O	XXX			2.19
			03 MAY 1998											
1	30	AFER Bilel	ALG	5	-	O	XO	O	O	XXO	XXO	XXO	XXX	2.24 PB
			11 FEB 2001											
	100	KONSTANTINOOU Vasilios	CYP	6										DNS
			13 SEP 1992											
10	390	VARELA BALDE' Gerson	POR	7	-	O	O	X-	-	XX				2.09
			28 JAN 2000											
9	450	ACET Alperen	TUR	8	-	-	O	O	XXX					2.13
			02 APR 1998											
8	287	FALOCCHI Christian	ITA	9	-	-	O	XO	XXO	XXX				2.16
			30 JAN 1997											
2	422	GHAZAL Majd Eddin	SYR	10	-	-	O	-	O	O	O	XXX		2.22
			21 APR 1987											

### Legend

- = Did Not Attempt  
DNS = Did Not Start  
NM = No Result  
ORD = Order  
SB = Season's Best  
DNF = Did Not Finish  
DQ = Disqualified  
O = Cleared  
PB = Personal Best  
X = Failed

Oran 30 Juin - 3 Juillet

ATHMHIGHJUMP-----FNL-000100--\_73M Data Processing and Timing by Microplus - www.microplustiming.com

1



## RESULTS

RANK	BIB	SURNAME & NAME	NOC	ORD	1.99	2.04	2.09	2.13	2.16	2.19	2.22	2.24	2.26	RESULT
			DATE OF BIRTH											

<b>WR</b>	<b>2.45</b>	<b>SOTOMAYOR Javier</b>			1967	CUB	SALAMANCA							27 JUL 1993
<b>CR</b>	<b>2.34</b>	<b>BANIOTIS Konstadinos</b>			2013	GRE	Mersin							27 JUL 2013

### As of 01/07/2022 at 20:19

12	101	<b>PAMPAKAS Kyriakos</b>	CYP	11	o	o	xxx							<b>2.04</b>
			14 JUL 2001											
7	289	<b>FASSINOTTI Marco</b>	ITA	12	-	-	o	-	xo	xo	xxx			<b>2.19</b>
			29 APR 1989											
5	197	<b>ISMAR Nathan</b>	FRA	13	-	-	o	o	o	o	xxx			<b>2.19</b>
			30 MAR 1999											

### Legend

- = Did Not Attempt	<b>DNF</b> = Did Not Finish
<b>DNS</b> = Did Not Start	<b>DQ</b> = Disqualified
<b>NM</b> = No Result	<b>O</b> = Cleared
<b>ORD</b> = Order	<b>PB</b> = Personal Best
<b>SB</b> = Season's Best	<b>X</b> = Failed

Oran 30 Juin - 3 Juillet

ATHMHIGHJUMP-----FNL-000100--\_73M 1 Data Processing and Timing by Microplus - www.microplustiming.com

2



## RESULTS

RANK	BIB	SURNAME & NAME	NOC	ORD	4.70	4.90	5.10	5.30	5.45	5.55	5.60	5.65	5.70	5.75	RESULT
				DATE OF BIRTH	5.81										

<b>WR</b>	<b>6.15</b>	<b>DUPLANTIS Armand</b>		1999	SWE	BERLIN									12 AUG 2018
<b>CR</b>	<b>5.70</b>	<b>ANDJI Alain</b>		1997	FRA	Bari									17 JUN 1997

### As of 02/07/2022 at 21:25

1	466	<b>SASMA Ersu</b>	TUR	7	-	-	-	O	O	O	O	O	O	XO	<b>5.75</b>	CR
			30 SEP 1999		XX											
2	181	<b>AMMIRATI Anthony</b>	FRA	10	-	-	-	O	XXO	XXO	-	XO	-	XXX	<b>5.65</b>	
			16 JUL 2003													
3	232	<b>RIZOS Ioannis</b>	GRE	11	-	-	XO	XO	XO	XO	XXO	XXX			<b>5.60</b>	PB
			02 MAR 2000													
4	189	<b>COLLET Mathieu</b>	FRA	4	-	-	O	O	O	XXX					<b>5.45</b>	
			15 MAR 1995													
5	141	<b>LEYVA DONAYRE Isidro</b>	ESP	2	-	-	O	O	XO	XXX					<b>5.45</b>	
			25 APR 1999													
6	298	<b>MANDUSIC Max</b>	ITA	1	-	-	-	O	XXX						<b>5.30</b>	
			12 JUN 1998													
7	39	<b>CHERABI Hichem Khalil</b>	ALG	5	-	-	O	XO	XXX						<b>5.30</b>	
			30 MAR 1991													
8	106	<b>STYLIANOU Nikandros</b>	CYP	6	O	O	XO	XXO	XXX						<b>5.30</b>	SB
			22 AUG 1989													
9	107	<b>TAMANIS Christos</b>	CYP	3	-	XO	XO	XXX							<b>5.10</b>	
			22 DEC 2000													

### NOT RANKED

284	<b>DE ANGELIS Ivan</b>		ITA	9												<b>DNS</b>
405	<b>RENNER Robert</b>		SLO	8												<b>DNS</b>

#### Details:

Start time:18:21  
Finish Time:21:19

Temperature:+26°C  
Temperature:+24°C

Humidity:65%  
Humidity:70%

#### Legend

- = Did Not Attempt	<b>CR</b> = Championship Record
<b>DNF</b> = Did Not Finish	<b>DNS</b> = Did Not Start
<b>DQ</b> = Disqualified	<b>NM</b> = No Result
<b>O</b> = Cleared	<b>ORD</b> = Order
<b>PB</b> = Personal Best	<b>SB</b> = Season's Best
<b>X</b> = Failed	

Oran 30 Juin - 3 Juillet

ATHMPLEVAULT-----FNL-000100--\_73M 1 Data Processing and Timing by Microplus - www.microplustiming.com

1



### RESULTS

RANK BIB SURNAME & NAME NOC ORD - 1 - - 2 - - 3 - - 4 - - 5 - - 6 - RESULT WIND  
DATE OF BIRTH

<b>WR</b>	<b>8.95</b>	<b>POWELL Mike</b>		1963	USA	TOKYO				30 AUG 1991
<b>CR</b>	<b>8.29</b>	<b>SDIRI Salim</b>		2009	FRA	Pescara				03 JUL 2009

#### As of 03/07/2022 at 20:11

RANK	BIB	SURNAME & NAME	NOC	ORD	1	2	3	4	5	6	RESULT	WIND
1	184	BEY Loucif	FRA	3	X	7.86	X	7.99	X	X	<b>7.99</b>	
					+0.5	+0.5	+0.4	+0.6	-0.2	+0.1	<b>+0.6</b>	
2	417	ANIC Lazar	SRB	7	7.59	7.64	7.80	X	7.68	7.83	<b>7.83</b>	SB
					-0.8	+0.5	+0.1	-0.2	+0.1	0.0	<b>0.0</b>	
3	59	TRIKI Yasser Mohammed T	ALG	6	7.59	7.61	7.10	7.61	7.56	7.80	<b>7.80</b>	SB
					+0.4	+0.3	+0.6	-0.5	+0.7	-0.5	<b>-0.5</b>	
4	186	CAMPAGNE Tom	FRA	2	X	7.73	7.78	7.60	7.61	7.03	<b>7.78</b>	
					0.0	+0.5	+0.9	+1.5	+0.2	-0.3	<b>+0.9</b>	
5	455	ER Necati	TUR	10	7.64	X	7.60	7.67	7.76	7.12	<b>7.76</b>	
					+0.8	+0.2	+0.5	+0.1	+0.8	-0.1	<b>+0.8</b>	
6	139	GUERRA ALEJANDRE Jaime	ESP	4	7.52	X	7.55	X	7.29	7.60	<b>7.60</b>	
					+1.0	+1.0	+0.1	+0.7	+0.7	+0.6	<b>+0.6</b>	
7	282	CHILA' Gabriele	ITA	5	7.26	X	7.58	7.53	X	7.10	<b>7.58</b>	
					+0.5	+0.3	+0.2	+0.8	+0.6	+0.4	<b>+0.2</b>	
8	338	HAJJAJI Yassine	MAR	11	7.21	7.50	7.57	7.20	7.33	6.96	<b>7.57</b>	SB
					-1.3	+0.6	+0.9	+0.8	-0.3	+1.0	<b>+0.9</b>	
9	305	QUARRATESI Jacopo	ITA	8	7.07	7.41	X				<b>7.41</b>	
					+0.4	+1.2	+0.7				<b>+1.2</b>	
10	46	HOCINE Tarek	ALG	1	7.02	6.98	7.00				<b>7.02</b>	
					+0.8	-0.1	+1.5				<b>+0.8</b>	

#### NOT RANKED

351	TRAJKOVSKI Andreas	MKD	9									<b>DNS</b>
				18 MAR 1993								

Starting order	1	2	3	4	5	6	7	8	9	10	11			
	46	186	184	139	282	59	417	305	351	455	338			

#### Details:

Start time:18:30  
Finish Time:20:10

Temperature:+25°C  
Temperature:+24°C

Humidity:75%  
Humidity:80%

#### Legend

- = Did Not Attempt	DNF = Did Not Finish
DNS = Did Not Start	DQ = Disqualified
NM = No Result	ORD = Order
SB = Season's Best	X = Failed



## RESULTS

RANK BIB SURNAME & NAME NOC DATE OF BIRTH RESULT WIND

WR	18.29	EDWARDS Jonathan	1966	GBR	GOETEBORG	07 AUG 1995
CR	17.13	HADJIANDREOU Marios	1991	CYP	Athens	

### As of 30/06/2022 at 20:17

1	59	TRIKI Yasser Mohammed T	ALG	24 MAR 1997	17.07	+0.6
2	281	BOCCHI Tobia	ITA	07 APR 1997	16.93	+1.0
3	385	LUOS PEREIRA Tiago Joao	POR	19 SEP 1993	16.90	+0.7
4	455	ER Necati	TUR	24 FEB 1997	16.52	+0.2
5	283	DALLAVALLE Andrea	ITA	31 OCT 1999	16.44	+1.0
6	403	LUXA Jan	SLO	11 FEB 1996	15.86	+0.9
7	339	HAMMADI Mohammed	MAR	08 AUG 1997	15.64	+0.9
8	28	ABINA Rida	ALG	07 FEB 1996	15.44	+0.9
9	359	GRECH Ian Paul	MLT	18 APR 1993	13.69	+0.9

Starting order	1	2	3	4	5	6	7	8	9						
Initial	339	385	359	283	403	281	59	455	28						
4th and 5th attempts	403	28	339	455	283	385	281	59							
6th attempt	28	339	403	283	455	385	281	59							

#### Details:

Start time:18:30  
Finish Time:21:12

Temperature:+25°C  
Temperature:+22°C

Humidity:75%  
Humidity:80%

### As of 30/06/2022 at 20:17

RANK	BIB	SURNAME & NAME	NOC	ORD	- 1 -	- 2 -	- 3 -	- 4 -	- 5 -	- 6 -	RESULT	WIND
7	339	HAMMADI Mohammed	MAR	1	X	15.64	X	X	15.56	15.63	15.64	
						+0.9			+0.9	+0.8	+0.9	
3	385	LUOS PEREIRA Tiago Joao	POR	3	16.65	X	16.47	16.21	16.63	16.90	16.90	
					+0.7	+1.4	+1.1	+0.6	+0.8	+0.7	+0.7	
9	359	GRECH Ian Paul	MLT	4	13.58	X	13.69				13.69	
					+1.2	+0.5	+0.9				+0.9	
5	283	DALLAVALLE Andrea	ITA	5	16.44						16.44	
					+1.0						+1.0	
6	403	LUXA Jan	SLO	6	X	X	14.86	15.86	X	15.44	15.86	
					+0.6	+1.1	+1.1	+0.9	+1.0	+0.9	+0.9	
2	281	BOCCHI Tobia	ITA	7	16.67	16.52	16.63	16.54	X	16.93	16.93	
					+0.8	+1.4	+0.9	+0.8	+0.3	+1.0	+1.0	
1	59	TRIKI Yasser Mohammed T	ALG	8	16.91	16.92	17.07	16.92	16.90	16.83	17.07	
					+0.4	+0.6	+0.6	+1.0	+0.8	+0.3	+0.6	
4	455	ER Necati	TUR	9	X	X	16.16	X	16.52	X	16.52	
					+1.5	+1.1	+1.3	+0.9	+0.2	+0.7	+0.2	
8	28	ABINA Rida	ALG	10	15.28	15.33	15.28	14.68	15.14	15.44	15.44	
					+0.9	+1.3	+1.1	+0.9	+0.9	+0.9	+0.9	

#### Legend

- = Did Not Attempt  
DNS = Did Not Start  
NM = No Result  
X = Failed

DNF = Did Not Finish  
DQ = Disqualified  
ORD = Order

Oran 30 Juin - 3 Juillet

ATHMTRPLJUMP-----FNL-000100--\_730 1 Data Processing and Timing by Microplus - www.microplustiming.com

1



## RESULTS

RANK BIB SURNAME & NAME NOC ORD - 1 - - 2 - - 3 - - 4 - - 5 - - 6 - RESULT  
DATE OF BIRTH

WR	23.37	CROUSER Ryan	1992	USA	EUGENE	18 JUN 2021
CR	21.03	MARTINEZ Manuel	2001	ESP	Rades	19 SEP 2001

### As of 30/06/2022 at 20:53

RANK	BIB	SURNAME & NAME	NOC	ORD	1	2	3	4	5	6	RESULT	SB
1	421	SINANCEVIC Armin	SRB	6	20.56	21.29	X	X	X	21.22	<b>21.29</b>	SB
		14 AUG 1996										
2	420	KOLASINAC Asmir	SRB	12	19.00	19.02	19.61	20.37	X	20.22	<b>20.37</b>	
		15 OCT 1984										
3	119	KHALIFA Mohamed	EGY	9	18.03	20.11	X	19.44	20.05	20.35	<b>20.35</b>	
		30 AUG 1996										
4	71	PEZER Mesud	BIH	5	20.23	19.92	19.73	-			<b>20.23</b>	
		27 AUG 1994										
5	389	ROSENOV ARNAUDOV Tsanko	POR	2	18.78	19.58	20.13	X	20.04	19.98	<b>20.13</b>	
		14 MAR 1992										
6	279	BIANCHETTI Sebastiano	ITA	3	19.42	20.03	X	19.57	X	X	<b>20.03</b>	
		20 JAN 1996										
7	228	MOUZENIDIS Odysseas	GRE	1	18.90	19.24	19.14	19.45	X	19.09	<b>19.45</b>	
		30 JUN 1999										
8	226	LATIFLLARI Anastasios	GRE	4	18.91	X	19.31	19.36	19.00	X	<b>19.36</b>	
		08 AUG 1996										
9	292	FERRARA Riccardo	ITA	7	18.61	19.18	X				<b>19.18</b>	
		22 JAN 2001										
10	313	RAMADANI Muhamet	KOS	11	17.26	17.55	18.06				<b>18.06</b>	
		11 AUG 2002										
11	209	MOUDANI-LIKIBI Fred	FRA	15	X	17.77	17.89				<b>17.89</b>	
		10 MAY 1999										
12	54	REDJECHTA Mohamed Raid Z	ALG	10	15.91	X	15.48				<b>15.91</b>	
		13 AUG 2002										
13	38	BOUZIANE Mohamed Reda	ALG	13	14.53	14.44	15.46				<b>15.46</b>	
		09 OCT 1994										

### NOT RANKED

364 DUROVIC Tomas MNE 14 DNS  
14 FEB 1994

Starting order	1	2	3	4	5	6	7	8	9	10	11	12	13	14
	228	389	279	226	71	421	292	119	54	313	420	38	364	209

#### Details:

Start time:19:20  
Finish Time:20:32

Temperature:+23°C  
Temperature:+23°C

Humidity:80%  
Humidity:80%

#### Legend

- = Did Not Attempt	DNF = Did Not Finish
DNS = Did Not Start	DQ = Disqualified
NM = No Result	ORD = Order
SB = Season's Best	X = Failed

Oran 30 Juin - 3 Juillet

ATHMSHOTPUT-----FNL-000100--\_73R 1. Data Processing and Timing by Microplus - www.microplustiming.com

1





## RESULTS

RANK BIB SURNAME & NAME NOC ORD - 1 - - 2 - - 3 - - 4 - - 5 - - 6 - RESULT  
DATE OF BIRTH

WR	74.08	SCHULT Juergen	1960	GDR	NEUBRANDENBU	06 JUN 1986
CR	65.58	CASANAS Frank	2009	ESP	Pescara	01 JUL 2009

### As of 03/07/2022 at 19:17

RANK	BIB	SURNAME & NAME	NOC	ORD	1	2	3	4	5	6	7	8	9	10	11	12	13	14	RESULT
1	102	PARELLIS Apostolos	CYP	11	63.59	60.67	62.77	62.69	X	62.78	<b>63.59</b>								
		24 JUL 1985																	
2	78	MARKOVIC Martin	CRO	14	59.01	62.49	X	60.96	X	60.97	<b>62.49</b>								
		13 JAN 1996																	
3	365	FURTULA Danijel	MNE	4	59.73	60.22	61.74	61.68	61.41	60.65	<b>61.74</b>								
		31 JUL 1992																	
4	241	REUX Tom	FRA	7	57.56	59.77	59.38	58.17	60.80	X	<b>60.80</b>								
		24 FEB 1999																	
5	98	GENETHLI Christoforos	CYP	6	56.04	59.60	56.80	56.87	X	57.99	<b>59.60</b>								
		19 FEB 1998																	
6	286	DI MARCO Nazzareno	ITA	10	59.02	57.24	58.49	59.01	X	59.52	<b>59.52</b>								
		30 APR 1985																	
7	48	KHENNOUSSI Oussama	ALG	5	58.93	X	54.81	X	57.77	X	<b>58.93</b>	PB							
		28 DEC 1999																	
8	465	SAHIN Omer	TUR	8	51.04	X	57.87	56.21	57.00	56.39	<b>57.87</b>								
		02 JUN 1995																	
9	454	CANKAYA Enes	TUR	1	57.43	52.12	56.80				<b>57.43</b>								
		21 MAR 2002																	
10	288	FALOCI Giovanni	ITA	3	X	57.30	X				<b>57.30</b>								
		13 OCT 1985																	
11	37	BOURAKBA Abdelmoumene	ALG	12	X	55.93	X				<b>55.93</b>								
		19 MAR 1988																	
12	135	CASAS GARRIDO Diego	ESP	9	53.18	54.80	X				<b>54.80</b>								
		29 APR 1999																	
13	361	MIFSUD Bradley	MLT	2	44.05	47.81	48.25				<b>48.25</b>								
		23 JAN 1996																	
14	314	SUMA Alaudin	KOS	13	43.90	43.20	42.13				<b>43.90</b>								
		03 APR 2002																	

Starting order	1	2	3	4	5	6	7	8	9	10	11	12	13	14
	454	361	288	365	48	98	241	465	135	286	102	37	314	78

#### Details:

Start time:18:05  
Finish Time:19:11

Temperature:+27°C  
Temperature:+26°C

Humidity:70%  
Humidity:75%

#### Legend

- = Did Not Attempt  
DNS = Did Not Start  
NM = No Result  
PB = Personal Best

DNF = Did Not Finish  
DQ = Disqualified  
ORD = Order  
X = Failed

Oran 30 Juin - 3 Juillet

ATHMDISCUS-----FNL-000100--\_73R 1.0 Data Processing and Timing by Microplus - www.microplustiming.com

1



## RESULTS

RANK	BIB	SURNAME & NAME	NOC	DATE OF BIRTH	RESULT
WR	84.90	DEVYATOVSKIY Vadim	1977	BLR Minsk	21 JUL 2015
CR	78.49	VIZZONI Nicola	2001	ITA Rades	14 SEP 2001

### As of 01/07/2022 at 20:26

1	452	BALTACI Ozkan	TUR	13 FEB 1994	74.34	
2	103	POURSANIDIS Alexandros	CYP	23 JAN 1993	73.71	SB
3	301	OLIVIERI Giorgio	ITA	05 NOV 2000	72.18	
4	383	FRANCISCO ANTUNES Ruben	POR	05 MAY 1999	71.62	SB
5	185	BRUXELLE Jean-baptiste	FRA	09 JUL 2002	71.16	
6	297	LINGUA Marco	ITA	04 JUN 1978	70.70	
7	117	ELGAMAL Mostafa	EGY	01 OCT 1988	70.48	
8	238	ZALTOS Konstantinos	GRE	05 FEB 2000	69.26	
9	229	NTOUSAKIS Orestis	GRE	02 MAY 2002	69.05	
10	116	ELASHRY Alaaeldin	EGY	06 JAN 1991	67.26	
11	138	GONZALEZ MOYANO Alberto	ESP	01 JUN 1998	66.49	

Starting order	1	2	3	4	5	6	7	8	9	10	11			
Initial	116	117	185	383	103	452	238	297	229	138	301			
4th and 5th attempts	238	297	117	383	185	301	103	452						
6th attempt	238	117	297	383	185	301	103	452						

Details:

Start time:18:00

Temperature:+26°C

### As of 01/07/2022 at 20:26

RANK	BIB	SURNAME & NAME	NOC	ORD	- 1 -	- 2 -	- 3 -	- 4 -	- 5 -	- 6 -	RESULT
10	116	ELASHRY Alaaeldin	EGY	1	66.51	65.40	67.26				67.26
					06 JAN 1991						
7	117	ELGAMAL Mostafa	EGY	2	70.48	69.99	69.72	X	69.89	70.17	70.48
					01 OCT 1988						
5	185	BRUXELLE Jean-baptiste	FRA	3	68.38	69.99	71.16	70.29	X	71.15	71.16
					09 JUL 2002						
4	383	FRANCISCO ANTUNES Ruben	POR	4	70.42	70.97	X	X	69.46	71.62	71.62 SB
					05 MAY 1999						
2	103	POURSANIDIS Alexandros	CYP	5	70.86	73.12	73.31	X	73.71	71.58	73.71 SB
					23 JAN 1993						
1	452	BALTACI Ozkan	TUR	6	73.47	73.19	74.34	73.50	72.82	73.67	74.34
					13 FEB 1994						
8	238	ZALTOS Konstantinos	GRE	7	69.26	68.93	67.87	66.85	66.90	67.84	69.26
					05 FEB 2000						
6	297	LINGUA Marco	ITA	8	70.22	69.74	X	X	70.70	69.41	70.70
					04 JUN 1978						
9	229	NTOUSAKIS Orestis	GRE	9	68.14	X	69.05				69.05
					02 MAY 2002						
11	138	GONZALEZ MOYANO Alberto	ESP	10	66.49	X	X				66.49
					01 JUN 1998						
3	301	OLIVIERI Giorgio	ITA	11	67.66	68.16	72.18	70.04	X	71.79	72.18
					05 NOV 2000						

#### Legend

- = Did Not Attempt  
DNS = Did Not Start  
NM = No Result  
SB = Season's Best

DNF = Did Not Finish  
DQ = Disqualified  
ORD = Order  
X = Failed

Oran 30 Juin - 3 Juillet

ATHMHAMMER-----FNL-000100--\_73R 1. Data Processing and Timing by Microplus - www.microplustiming.com

1



## RESULTS

RANK BIB SURNAME & NAME NOC ORD - 1 - - 2 - - 3 - - 4 - - 5 - - 6 - RESULT  
DATE OF BIRTH

WR	98.48	ZELEZNY Jan	1966	CZE	JENA	5/996
CR	89.22	GATSIODIS Kostas	1997	GRE	Bari	

### As of 02/07/2022 at 20:45

RANK	BIB	SURNAME & NAME	NOC	ORD	1	2	3	4	5	6	7	8	9	10	RESULT
1	388	RAMOS Leandro Parreças	POR	7	72.91	69.51	82.23	X	-	74.47	<b>82.23</b>				
		21 SEP 2000													
2	113	ABDELRAHMAN Ihab	EGY	5	74.52	75.04	71.74	75.44	78.05	78.51	<b>78.51</b>				
		01 MAY 1989													
3	212	VAHAI-SOSAIA Felise	FRA	10	73.32	76.45	75.73	X	72.03	72.83	<b>76.45</b>				
		30 JUL 1999													
4	69	MILEUSNIC Dejan	BIH	6	73.90	72.43	71.44	74.46	75.70	X	<b>75.70</b>	SB			
		16 NOV 1991													
5	302	ORLANDO Roberto	ITA	3	70.17	73.01	69.94	73.68	72.98	74.27	<b>74.27</b>				
		05 AUG 1995													
6	461	ONCEL Emin	TUR	9	70.77	73.95	72.30	70.09	X	-	<b>73.95</b>				
		01 MAY 1997													
7	115	AMER Maged	EGY	1	70.89	69.85	70.32	67.94	69.52	71.21	<b>71.21</b>				
		29 SEP 1995													
8	236	TSITSOS Dimitrios	GRE	2	65.88	69.71	69.64	-	X	X	<b>69.71</b>				
		27 SEP 2000													
9	190	CONROY Remi	FRA	4	69.44	65.58	68.08				<b>69.44</b>				
		17 JUN 1998													
10	104	SAVVA Spyros	CYP	8	X	67.14	X				<b>67.14</b>				
		24 JAN 2000													

Starting order	1	2	3	4	5	6	7	8	9	10					
	115	236	302	190	113	69	388	104	461	212					

#### Details:

Start time:19:28  
Finish Time:20:45

Temperature:+26°C  
Temperature:+24°C

Humidity:65%  
Humidity:78%

#### Legend

- = Did Not Attempt	DNF = Did Not Finish
DNS = Did Not Start	DQ = Disqualified
NM = No Result	ORD = Order
SB = Season's Best	X = Failed

Oran 30 Juin - 3 Juillet

ATHMJAVELIN-----FNL-000100--\_73R 1.0 Data Processing and Timing by Microplus - www.microplustiming.com

1



Complexe Olympique - Grand Stade  
Athletic  
Men's 4 x 100 Relay - Final



RESULTS

RANK	BIB	TEAM	NOC	LANE	R.T.	TIME
WR	36.84	JAMAICA	JAM	LONDON		8/012
CR	38.49	ITALY	2018 ITA	Tarragona		30 JUN 2018

As of 01/07/2022 at 20:22

1	ITALY	ITA	4	0.168	38.95
2	TURKIYE	TUR	6	0.158	38.98
3	FRANCE	FRA	5	0.175	39.08
4	GREECE	GRE	7	0.171	39.10

NOT RANKED

MOROCCO

3

DNS

Details:

Start time:20:21

Temperature:+25°C

Humidity:85%

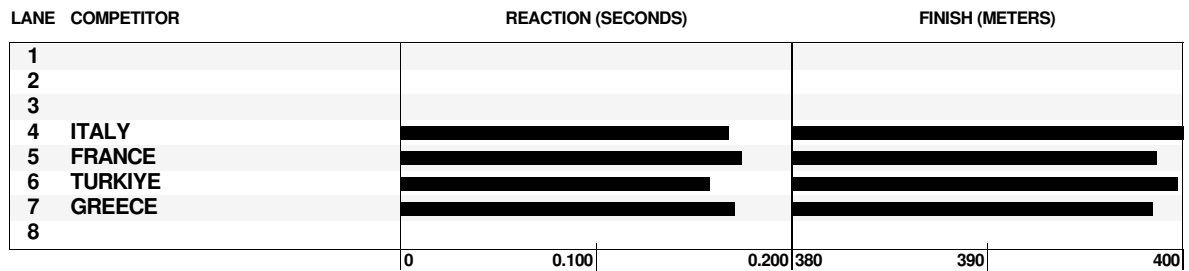

Legend

DNF = Did Not Finish  
DQ = Disqualified  
R.T. = Reaction

DNS = Did Not Start  
Fn = False Start

Oran 30 Juin - 3 Juillet

ATHM4X100M-----FNL-000100--\_73E 1.0 Data Processing and Timing by Microplus - www.microplustiming.com

1



Complexe Olympique - Grand Stade  
Athletic  
Men's 4 x 400 Relay - Final



**REVISED**

**RESULTS**

RANK	BIB	TEAM	NOC	LANE	R.T.	TIME
WR		2:54.29 UNITED STATES	USA	STUTTGART		8/993
CR		3:02.78 ALGERIA	1997 ALG	Bari		17 JUN 1997

As of 03/07/2022 at 21:34

1	<b>ALGERIA</b>	ALG	8	0.163	<b>3:03.41</b>
	32 BENDJEMAA Abdenmour - 42 GOUANED Mohamed Ali - 50 LAHOULOU Abdelmalik - 53 MOULA Slimane				
2	<b>ITALY</b>	ITA	6	0.166	<b>3:04.55</b>
	304 PIVOTTO Pietro - 296 LEONARDI Giuseppe - 280 BIANCIARDI Lapo - 307 RAIMONDI Matteo				
3	<b>TURKIYE</b>	TUR	3	0.164	<b>3:04.55</b>
	469 KAYA Oguzhan - 456 ESCOBAR Yasmani Copello - 462 OREN Sinan - 460 NEZIR Ismail				
4	<b>SLOVENIA</b>	SLO	5	0.205	<b>3:05.12</b>
	401 GRKMAN Jure - 404 MESEC KOSIR Lovro - 400 GRAHOVAC Gregor - 399 FERLAN Rok				
5	<b>FRANCE</b>	FRA	7	0.199	<b>3:05.35</b>
	213 VAILLANT Ludvy - 210 NALIALI Christopher - 203 LE MEUR Ludovic - 199 KOUNTA Muhammad				
6	<b>MOROCCO</b>	MAR	2	0.197	<b>3:07.04</b>
	344 M'HAMDI Rachid - 348 SMAILI Mostafa - 342 MANYANI Ismail - 335 DAIR Hamza				

**NOT RANKED**

**TUNISIA** TUN 4 **DNS**  
424 AYOUNI Abdessalem - 425 BALTI Rami - 426 CHNINNI Riadh - 430 JLASSI Mohamed Fares - 432 TOUATI Mohamed Ami

Details: Start time:20:25 Temperature:+24°C Humidity:80%

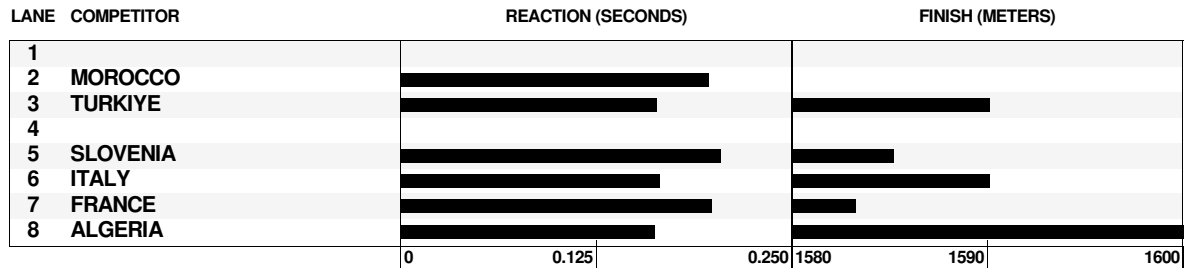

**Legend**

DNF = Did Not Finish      DNS = Did Not Start  
DQ = Disqualified      Fn = False Start  
R.T. = Reaction

Oran 30 Juin - 3 Juillet

ATHM4X400M-----FNL-000100--\_73E 1.0 Data Processing and Timing by Microplus - www.microplustiming.com





## RESULTS

RANK	BIB	SURNAME & NAME	NOC	DATE OF BIRTH	LANE	R.T.	TIME
WR	10.49	GRIFFITH-JOYNER Florence	1959	USA	INDIANAPOLIS		16 JUL 1988
CR	11.13	THANOU Ekaterini	1997	GRE	Bari		

As of 30/06/2022 at 20:21

(Wind: +0.5 m/s)

RANK	BIB	SURNAME & NAME	NOC	DATE OF BIRTH	LANE	R.T.	TIME
1	111	HEMIDA Basant	EGY	28 SEP 1996	6	0.130	11.10
2	369	BAZOLO Lorene Dorcas	POR	04 MAY 1983	5	0.173	11.36
3	86	FOTOPOULOU Olivia	CYP	20 DEC 1996	3	0.156	11.42
4	126	MARCO MORA Carmen	ESP	17 DEC 1999	4	0.158	11.48
5	255	HOOPER Gloria	ITA	03 MAR 1992	8	0.191	11.62
6	321	EDDAOU Hajar	MAR	15 AUG 1999	2	0.174	11.65
7	243	BELLINAZZI Giorgia	ITA	20 JUL 2000	7	0.176	11.71
8	434	AY Mizgin	TUR	01 JAN 2000	1	0.157	11.86

Details:

Start time:20:20

Temperature:+23°C

Humidity:80%



### Legend

DNF = Did Not Finish  
DQ = Disqualified  
R.T. = Reaction

DNS = Did Not Start  
Fn = False Start

Oran 30 Juin - 3 Juillet

ATHW100M-----FNL-000100--\_73A 1.0 Data Processing and Timing by Microplus - www.microplustiming.com

1



## RESULTS

RANK	BIB	SURNAME & NAME	NOC	DATE OF BIRTH	LANE	R.T.	TIME
WR	10.49	GRIFFITH-JOYNER Florence	USA	1959	INDIANAPOLIS		16 JUL 1988
CR	11.13	THANOU Ekaterini	GRE	1997	Bari		

As of 30/06/2022 at 18:46

(Wind: +0.7 m/s)

1	369	BAZOLO Lorene Dorcas	POR	04 MAY 1983	6	0.180	11.38 Q
2	86	FOTOPOULOU Olivia	CYP	20 DEC 1996	2	0.167	11.43 Q
3	255	HOOPER Gloria	ITA	03 MAR 1992	3	0.195	11.59 Q
4	321	EDDAOU Hajar	MAR	15 AUG 1999	7	0.179	11.66 q
5	434	AY Mizgin	TUR	01 JAN 2000	4	0.162	11.78 q
6	25	TOUATI Amina	ALG	27 FEB 2001	8	0.196	12.35

### NOT RANKED

366 AFRIAT Charlotte MON 17 OCT 2002 5 DNS

Qualification: First 3 in each heat (Q) and 2 fastest (q) to Final

Details: Start time:18:45 Temperature:+24°C Humidity:80%

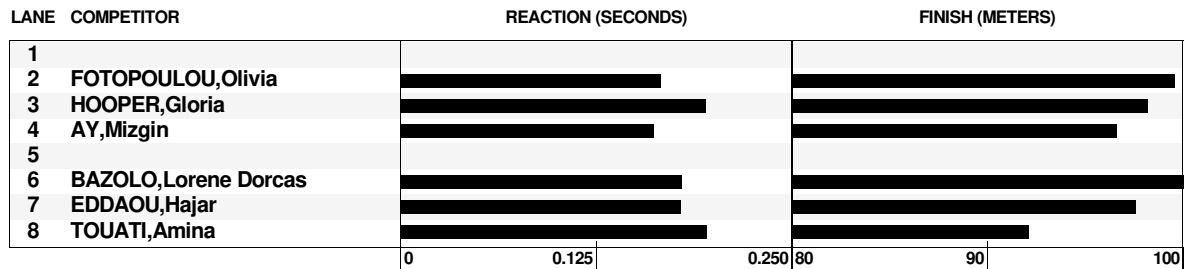

#### Legend

DNF = Did Not Finish  
DQ = Disqualified  
R.T. = Reaction  
DNS = Did Not Start  
Fn = False Start

Oran 30 Juin - 3 Juillet

ATHW100M-----RND1000100--\_73A 1.0 Data Processing and Timing by Microplus - www.microplustiming.com

1



## RESULTS

RANK	BIB	SURNAME & NAME	NOC	DATE OF BIRTH	LANE	R.T.	TIME
WR	10.49	GRIFFITH-JOYNER Florence	USA	1959	INDIANAPOLIS		16 JUL 1988
CR	11.13	THANOU Ekaterini	GRE	1997	Bari		

As of 30/06/2022 at 18:54

(Wind: +0.6 m/s)

1	111	HEMIDA Basant	EGY	28 SEP 1996	7	0.164	11.23 Q
2	126	MARCO MORA Carmen	ESP	17 DEC 1999	8	0.173	11.56 Q
3	243	BELLINAZZI Giorgia	ITA	20 JUL 2000	2	0.181	11.75 Q
4	412	ILIC Ivana	SRB	08 JUN 2002	6	0.176	11.82
5	92	PISIARA Marianna	CYP	10 MAY 1997	4	0.175	11.92
6	407	GASPARELLI Alessandra	SMR	03 SEP 2004	5	0.170	11.96

### NOT RANKED

375 DOS SANTOS KGASI Maria R POR 18 FEB 1998 3 DNS

Qualification: First 3 in each heat (Q) and 2 fastest (q) to Final

Details: Start time:18:50 Temperature:+24°C Humidity:10%

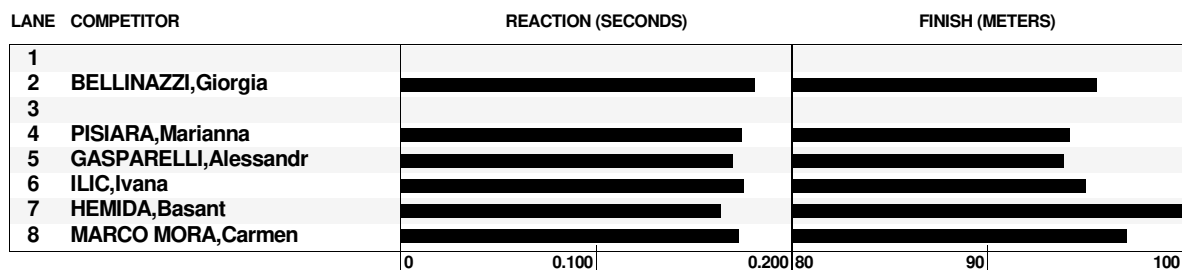

#### Legend

DNF = Did Not Finish  
DQ = Disqualified  
R.T. = Reaction

DNS = Did Not Start  
Fn = False Start





## SUMMARY

RANK	BIB	SURNAME & NAME	NOC	DATE OF BIRTH	HEAT	LANE	RANK	WIND	TIME	
<b>WR</b>	<b>10.49</b>	<b>GRIFFITH-JOYNER Florence</b>	1959	USA	INDIANAPOLIS				16 JUL 1988	
<b>CR</b>	<b>11.13</b>	<b>THANOU Ekaterini</b>	1997	GRE	Bari					
1	111	<b>HEMIDA Basant</b>	EGY	28 SEP 1996	2	7	1	+0.6	<b>11.23</b>	Q
2	369	<b>BAZOLO Lorene Dorcas</b>	POR	04 MAY 1983	1	6	1	+0.7	<b>11.38</b>	Q
3	86	<b>FOTOPOULOU Olivia</b>	CYP	20 DEC 1996	1	2	2	+0.7	<b>11.43</b>	Q
4	126	<b>MARCO MORA Carmen</b>	ESP	17 DEC 1999	2	8	2	+0.6	<b>11.56</b>	Q
5	255	<b>HOOPER Gloria</b>	ITA	03 MAR 1992	1	3	3	+0.7	<b>11.59</b>	Q
6	321	<b>EDDAOU Hajar</b>	MAR	15 AUG 1999	1	7	4	+0.7	<b>11.66</b>	q
7	243	<b>BELLINAZZI Giorgia</b>	ITA	20 JUL 2000	2	2	3	+0.6	<b>11.75</b>	Q
8	434	<b>AY Mizgin</b>	TUR	01 JAN 2000	1	4	5	+0.7	<b>11.78</b>	q
9	412	<b>ILIC Ivana</b>	SRB	08 JUN 2002	2	6	4	+0.6	<b>11.82</b>	
10	92	<b>PISIARA Marianna</b>	CYP	10 MAY 1997	2	4	5	+0.6	<b>11.92</b>	
11	407	<b>GASPARELLI Alessandra</b>	SMR	03 SEP 2004	2	5	6	+0.6	<b>11.96</b>	
12	25	<b>TOUATI Amina</b>	ALG	27 FEB 2001	1	8	6	+0.7	<b>12.35</b>	

### NOT RANKED

366	<b>AFRIAT Charlotte</b>	MON	17 OCT 2002	1	5		+0.7	<b>DNS</b>
375	<b>DOS SANTOS KGASI Maria R</b>	POR	18 FEB 1998	2	3		+0.6	<b>DNS</b>

Qualification: First 3 in each heat (Q) and 2 fastest (q) to Final

#### Legend

**DNF** = Did Not Finish  
**DQ** = Disqualified  
**R.T.** = Reaction

**DNS** = Did Not Start  
**Fn** = False Start



## RESULTS

RANK	BIB	SURNAME & NAME	NOC	DATE OF BIRTH	LANE	R.T.	TIME
WR	21.34	GRIFFITH-JOYNER Florence	USA	1959	SEOUL		29 SEP 1988
CR	22.62	ARRON Christine	FRA	1997	Bari		17 JUN 1997

As of 03/07/2022 at 18:11

(Wind: +0.9 m/s)

RANK	BIB	SURNAME & NAME	NOC	DATE OF BIRTH	LANE	R.T.	TIME	REMARKS
1	111	HEMIDA Basant	EGY	28 SEP 1996	4	0.178	<b>22.47</b>	CR
2	86	FOTOPOULOU Olivia	CYP	20 DEC 1996	6	0.175	<b>23.01</b>	
3	369	BAZOLO Lorene Dorcas	POR	04 MAY 1983	5	0.178	<b>23.20</b>	
4	269	SIRAGUSA Irene	ITA	23 JUN 1993	8	0.160	<b>23.27</b>	
5	132	SANTIDRIAN RUIZ Eva	ESP	25 JAN 2000	3	0.187	<b>23.33</b>	PB
6	161	JOSEPH Gemima	FRA	17 OCT 2001	2	0.159	<b>23.41</b>	SB
7	321	EDDAOU Hajar	MAR	15 AUG 1999	1	0.189	<b>23.73</b>	PB
8	245	BRUNEY Maya Fonda	ITA	24 FEB 1998	7	0.173	<b>23.81</b>	

Details:

Start time:18:10

Temperature:+27°C

Humidity:70%



### Legend

CR = Championship Record  
DNS = Did Not Start  
Fn = False Start  
R.T. = Reaction

DNF = Did Not Finish  
DQ = Disqualified  
PB = Personal Best  
SB = Season's Best

Oran 30 Juin - 3 Juillet

ATHW200M-----FNL-000100--\_73A 1.0 Data Processing and Timing by Microplus - www.microplustiming.com

1



# Complexe Olympique - Grand Stade

## Athletic Women's 200 m - 1st Round Heat 1 of 2



### RESULTS

RANK	BIB	SURNAME & NAME	NOC	DATE OF BIRTH	LANE	R.T.	TIME
WR	21.34	GRIFFITH-JOYNER Florence	USA	1959	SEOUL		29 SEP 1988
CR	22.62	ARRON Christine	FRA	1997	Bari		17 JUN 1997

As of 02/07/2022 at 18:42

(Wind: +0.6 m/s)

1	111	HEMIDA Basant	EGY	28 SEP 1996	2	0.161	22.89 Q
2	86	FOTOPOULOU Olivia	CYP	20 DEC 1996	8	0.159	22.99 Q PB
3	245	BRUNEY Maya Fonda	ITA	24 FEB 1998	3	0.160	23.66 Q
4	27	ZINE Djamila	ALG	17 MAR 1997	6	0.237	24.57 SB
5	407	GASPARELLI Alessandra	SMR	03 SEP 2004	1	0.134	24.93
6	63	MALAGA MORAN Carlota Mer	AND	16 JAN 2002	5	0.337	26.62

### NOT RANKED

375	DOS SANTOS KGASI Maria R	POR	18 FEB 1998	4	DNS
434	AY Mizgin	TUR	01 JAN 2000	7	DNS

Qualification: First 3 in each heat (Q) and 2 fastest (q) to Final

Details:

Start time:18:40

Temperature:+26°C

Humidity:65%



#### Legend

DNF = Did Not Finish  
 DQ = Disqualified  
 PB = Personal Best  
 SB = Season's Best

DNS = Did Not Start  
 Fn = False Start  
 R.T. = Reaction

Oran 30 Juin - 3 Juillet

ATHW200M-----ND1000100--\_73A 1.0 Data Processing and Timing by Microplus - www.microplustiming.com

Report Created 05 JUL 2022 at 15:18

1



# Complexe Olympique - Grand Stade

## Athletic Women's 200 m - 1st Round Heat 2 of 2



### RESULTS

RANK	BIB	SURNAME & NAME	NOC	DATE OF BIRTH	LANE	R.T.	TIME
WR	21.34	GRIFFITH-JOYNER Florence	USA	1959	SEOUL		29 SEP 1988
CR	22.62	ARRON Christine	FRA	1997	Bari		17 JUN 1997

As of 02/07/2022 at 18:50

(Wind: +0.8 m/s)

1	369	BAZOLO Lorene Dorcas	POR	04 MAY 1983	2	0.170	23.22 Q
2	132	SANTIDRIAN RUIZ Eva	ESP	25 JAN 2000	7	0.204	23.56 Q PB
3	269	SIRAGUSA Irene	ITA	23 JUN 1993	5	0.178	23.59 Q
4	161	JOSEPH Gemima	FRA	17 OCT 2001	1	0.206	23.62 q
5	321	EDDAOU Hajar	MAR	15 AUG 1999	4	0.194	23.77 q PB
6	412	ILIC Ivana	SRB	08 JUN 2002	6	0.187	24.39
7	414	MILUTINOVIC Tamara	SRB	18 NOV 2001	8	0.166	24.48 SB
8	92	PISIARA Marianna	CYP	10 MAY 1997	3	0.304	24.59

Qualification: First 3 in each heat (Q) and 2 fastest (q) to Final

Details:

Start time:18:47

Temperature:+26°C

Humidity:65%

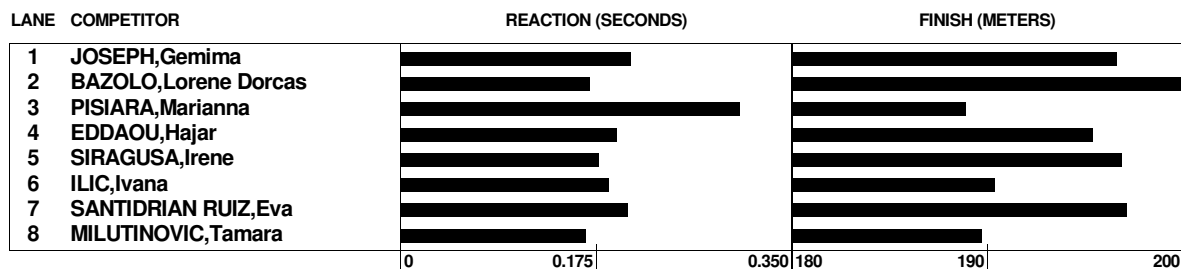

#### Legend

DNF = Did Not Finish  
 DQ = Disqualified  
 PB = Personal Best  
 SB = Season's Best

DNS = Did Not Start  
 Fn = False Start  
 R.T. = Reaction

Oran 30 Juin - 3 Juillet

ATHW200M-----ND1000100--\_73A 1.0 Data Processing and Timing by Microplus - www.microplustiming.com

Report Created 05 JUL 2022 at 15:18

2



## SUMMARY

RANK	BIB	SURNAME & NAME	NOC	DATE OF BIRTH	HEAT	LANE	RANK	WIND	TIME	
WR	21.34	GRIFFITH-JOYNER Florence	USA	1959	SEOUL				29 SEP 1988	
CR	22.62	ARRON Christine	FRA	1997	Bari				17 JUN 1997	
1	111	HEMIDA Basant	EGY	28 SEP 1996	1	2	1	+0.6	<b>22.89</b>	Q
2	86	FOTOPOULOU Olivia	CYP	20 DEC 1996	1	8	2	+0.6	<b>22.99</b>	Q PB
3	369	BAZOLO Lorene Dorcas	POR	04 MAY 1983	2	2	1	+0.8	<b>23.22</b>	Q
4	132	SANTIDRIAN RUIZ Eva	ESP	25 JAN 2000	2	7	2	+0.8	<b>23.56</b>	Q PB
5	269	SIRAGUSA Irene	ITA	23 JUN 1993	2	5	3	+0.8	<b>23.59</b>	Q
6	161	JOSEPH Gemima	FRA	17 OCT 2001	2	1	4	+0.8	<b>23.62</b>	q
7	245	BRUNEY Maya Fonda	ITA	24 FEB 1998	1	3	3	+0.6	<b>23.66</b>	Q
8	321	EDDAOU Hajar	MAR	15 AUG 1999	2	4	5	+0.8	<b>23.77</b>	q PB
9	412	ILIC Ivana	SRB	08 JUN 2002	2	6	6	+0.8	<b>24.39</b>	
10	414	MILUTINOVIC Tamara	SRB	18 NOV 2001	2	8	7	+0.8	<b>24.48</b>	SB
11	27	ZINE Djamila	ALG	17 MAR 1997	1	6	4	+0.6	<b>24.57</b>	SB
12	92	PISIARA Marianna	CYP	10 MAY 1997	2	3	8	+0.8	<b>24.59</b>	
13	407	GASPARELLI Alessandra	SMR	03 SEP 2004	1	1	5	+0.6	<b>24.93</b>	
14	63	MALAGA MORAN Carlota Mer	AND	16 JAN 2002	1	5	6	+0.6	<b>26.62</b>	

## NOT RANKED

375	DOS SANTOS KGASI Maria R	POR	18 FEB 1998	1	4			+0.6	<b>DNS</b>	
434	AY Mizgin	TUR	01 JAN 2000	1	7			+0.6	<b>DNS</b>	

Qualification: First 3 in each heat (Q) and 2 fastest (q) to Final

### Legend

DNF = Did Not Finish	DNS = Did Not Start
DQ = Disqualified	Fn = False Start
PB = Personal Best	R.T. = Reaction
SB = Season's Best	

Oran 30 Juin - 3 Juillet

ATHW200M-----RND1-----\_74A 1.0 Data Processing and Timing by Microplus - www.microplustiming.com

1



## RESULTS

RANK	BIB	SURNAME & NAME	NOC	DATE OF BIRTH	LANE	R.T.	TIME
WR	47.60	KOCH Marita	1957	GDR	CANBERRA		06 OCT 1985
CR	50.30	GRENOT Libania	2009	ITA	Pescara		02 JUL 2019

### As of 02/07/2022 at 20:02

RANK	BIB	SURNAME & NAME	NOC	DATE OF BIRTH	LANE	R.T.	TIME	SB
1	373	DA SILVA AZEVEDO C tia I	POR	09 MAR 1994	5	0.232	51.24	SB
2	393	HORVAT Anita	SLO	07 SEP 1996	3	0.189	51.94	SB
3	273	TROIANI Virginia	ITA	22 FEB 1996	4	0.195	53.14	
4	257	LUKUDO Raphaela Boaheng	ITA	29 JUL 1994	6	0.196	53.37	
5	449	YILDIRIM Busra	TUR	10 MAY 1996	7	0.268	53.59	
6	125	HERVAS RODRIGUEZ Blanca	ESP	30 SEP 2002	8	0.184	54.23	
7	12	BOULEHSA Meriem	ALG	03 OCT 1992	1	0.251	55.87	SB
8	322	EL HACHIMI Sara	MAR	06 JUN 2000	2	0.210	56.99	

Details: Start time:20:00 Temperature:+25°C Humidity:70%



### Legend

DNF = Did Not Finish	DNS = Did Not Start
DQ = Disqualified	Fn = False Start
R.T. = Reaction	SB = Season's Best

Oran 30 Juin - 3 Juillet

ATHW400M-----FNL-000100--\_73A 1.0 Data Processing and Timing by Microplus - www.microplustiming.com

1



## RESULTS

RANK BIB SURNAME & NAME NOC DATE OF BIRTH LANE R.T. TIME

WR	1:53.28	KRATOCHVILOVA Jarmila	1951	TCH	MUNCHEN	26 JUL 1983
CR	1:59.87	PICCIONE Elisa Cusma	2009	ITA	Pescara	02 JUL 2009

### As of 02/07/2022 at 19:18

1	440	EKATERINE Guliyev	TUR	01 MAR 1991	4	2:01.08	SB
2	249	COIRO Eloisa	ITA	01 DEC 2000	8	2:01.40	PB
3	330	RAZIKI Assia	MAR	04 OCT 1996	5	2:01.44	PB
4	370	CABRAL DA SILVA Patricia	POR	09 DEC 1999	2	2:03.12	PB
5	124	GARCIA TENA Daniela	ESP	31 AUG 2001	6	2:03.45	
6	396	SMONKAR Jerneja	SLO	27 JAN 1992	7	2:03.82	
7	175	SAHNOUNE Meriem	FRA	05 JUN 1994	3	2:05.19	
8	447	TOPTAS Tugba	TUR	11 JUL 2000	1	2:05.33	

### Intermediate point leaders (Bib and Time):

400 m : 440 1:01.32

### Details:

Start time:19:15

Temperature:+26°C

Humidity:65%

LANE	COMPETITOR	REACTION (SECONDS)	FINISH (METERS)
1	TOPTAS,Tugba		
2	CABRAL DA SILVA,Patr		
3	SAHNOUNE,Meriem		
4	EKATERINE,Guliyev		
5	RAZIKI,Assia		
6	GARCIA TENA,Daniela		
7	SMONKAR,Jerneja		
8	COIRO,Eloisa		

### Legend

DNF = Did Not Finish  
DQ = Disqualified  
PB = Personal Best  
SB = Season's Best

DNS = Did Not Start  
Fn = False Start  
R.T. = Reaction

Oran 30 Juin - 3 Juillet

ATHW800M-----FNL-000100--\_73A 1.0 Data Processing and Timing by Microplus - www.microplustiming.com

1



Complexe Olympique - Grand Stade  
Athletic  
Women's 800 m - 1st Round  
Heat 1 of 2



RESULTS

RANK	BIB	SURNAME & NAME	NOC	DATE OF BIRTH	LANE	R.T.	TIME
WR	1:53.28	KRATOCHVILOVA Jarmila	1951	TCH	MUNCHEN		26 JUL 1983
CR	1:59.87	PICCIONE Elisa Cusma	2009	ITA	Pescara		02 JUL 2009

As of 30/06/2022 at 19:38

1	124	GARCIA TENA Daniela	ESP	31 AUG 2001	7		2:05.92 Q
2	330	RAZIKI Assia	MAR	04 OCT 1996	6		2:06.39 Q
3	447	TOPTAS Tugba	TUR	11 JUL 2000	8		2:06.82 Q
4	259	MATTAGLIANO Joyce	ITA	03 MAY 1994	4		2:06.85
5	171	PIZZO Charlotte	FRA	10 MAY 1997	5		2:07.44
6	23	REZZIK Ghania	ALG	21 DEC 2002	3		2:09.90

Qualification: First 3 in each heat (Q) and 2 fastest (q) to Final

Intermediate point leaders (Bib and Time):

400 m : 259 1:03.08

Details:

Start time:19:35

Temperature:+23°C

Humidity:80%

LANE	COMPETITOR	REACTION (SECONDS)	FINISH (METERS)
1			
2			
3	REZZIK, Ghania		
4	MATTAGLIANO, Joyce		
5	PIZZO, Charlotte		
6	RAZIKI, Assia		
7	GARCIA TENA, Daniela		
8	TOPTAS, Tugba		

Legend

DNF = Did Not Finish  
DQ = Disqualified  
R.T. = Reaction

DNS = Did Not Start  
Fn = False Start

Oran 30 Juin - 3 Juillet

ATHW800M-----RND1000100--\_73A 1.0 Data Processing and Timing by Microplus - www.microplustiming.com

1





## RESULTS

RANK	BIB	SURNAME & NAME	NOC	DATE OF BIRTH	LANE	R.T.	TIME
WR	1:53.28	KRATOCHVILOVA Jarmila	1951	TCH	MUNCHEN		26 JUL 1983
CR	1:59.87	PICCIONE Elisa Cusma	2009	ITA	Pescara		02 JUL 2009

### As of 30/06/2022 at 19:42

1	440	EKATERINE Guliyev	TUR	01 MAR 1991	4		2:02.64 Q
2	249	COIRO Eloisa	ITA	01 DEC 2000	7		2:03.16 Q
3	396	SMONKAR Jerneja	SLO	27 JAN 1992	2		2:04.25 Q
4	175	SAHNOUNE Meriem	FRA	05 JUN 1994	8		2:04.30 q
5	370	CABRAL DA SILVA Patricia	POR	09 DEC 1999	6		2:05.06 q
6	320	BENKASSEM Khadija	MAR	20 APR 1998	3		2:05.56

### NOT RANKED

19 MOUICI Roukia ALG 01 JAN 2003 5 DNS

Qualification: First 3 in each heat (Q) and 2 fastest (q) to Final

Intermediate point leaders (Bib and Time):

400 m : 440 1:00.84

Details: Start time:19:39 Temperature:+23°C Humidity:80%

LANE	COMPETITOR	REACTION (SECONDS)	FINISH (METERS)
1			
2	SMONKAR,Jerneja		
3	BENKASSEM,Khadija		
4	EKATERINE,Guliyev		
5			
6	CABRAL DA SILVA,Patr		
7	COIRO,Eloisa		
8	SAHNOUNE,Meriem		

### Legend

DNF = Did Not Finish  
DQ = Disqualified  
R.T. = Reaction

DNS = Did Not Start  
Fn = False Start



## SUMMARY

RANK	BIB	SURNAME & NAME	NOC	DATE OF BIRTH	HEAT	LANE	RANK	WIND	TIME
WR	1:53.28	KRATOCHVILOVA Jarmila	1951	TCH	MUNCHEN				26 JUL 1983
CR	1:59.87	PICCIONE Elisa Cusma	2009	ITA	Pescara				02 JUL 2009
1	440	EKATERINE Guliyev	TUR	01 MAR 1991	2	4	1		2:02.64 Q
2	249	COIRO Eloisa	ITA	01 DEC 2000	2	7	2		2:03.16 Q
3	396	SMONKAR Jerneja	SLO	27 JAN 1992	2	2	3		2:04.25 Q
4	175	SAHNOUNE Meriem	FRA	05 JUN 1994	2	8	4		2:04.30 q
5	370	CABRAL DA SILVA Patricia	POR	09 DEC 1999	2	6	5		2:05.06 q
6	320	BENKASSEM Khadija	MAR	20 APR 1998	2	3	6		2:05.56
7	124	GARCIA TENA Daniela	ESP	31 AUG 2001	1	7	1		2:05.92 Q
8	330	RAZIKI Assia	MAR	04 OCT 1996	1	6	2		2:06.39 Q
9	447	TOPTAS Tugba	TUR	11 JUL 2000	1	8	3		2:06.82 Q
10	259	MATTAGLIANO Joyce	ITA	03 MAY 1994	1	4	4		2:06.85
11	171	PIZZO Charlotte	FRA	10 MAY 1997	1	5	5		2:07.44
12	23	REZZIK Ghania	ALG	21 DEC 2002	1	3	6		2:09.90

## NOT RANKED

19	MOUICI Roukia	ALG	01 JAN 2003	2	5				DNS
----	---------------	-----	-------------	---	---	--	--	--	-----

Qualification: First 3 in each heat (Q) and 2 fastest (q) to Final

### Legend

DNF = Did Not Finish  
DQ = Disqualified  
R.T. = Reaction

DNS = Did Not Start  
Fn = False Start



## RESULTS

RANK	BIB	SURNAME & NAME	NOC	DATE OF BIRTH	ORD	TIME
WR		3:50.07 DIBABA Genzebe	1991	ETH	MONACO	17 JUL 2015
CR		4:04.06 HILALI Siham	2013	MAR	Mersin	26 JUN 2013

### As of 03/07/2022 at 18:56

1	152	FLEURY Aurore	FRA	1993	14	4:13.03	
2	250	DEL BUONO Federica	ITA	1994	11	4:13.09	
3	247	CAVALLI Ludovica	ITA		9	4:13.37	
4	127	MARTINEZ ORTUNO Marina	ESP	2002	1	4:14.04	
5	436	AYYILDIZ Silan	TUR	1999	6	4:14.45	
6	150	CLEYET-MERLE Berenice	FRA	1994	10	4:16.77	
7	377	MACHADO CARVALHO Mariana	POR		13	4:17.24	
8	319	AZROUR Meryeme	MAR	2002	15	4:18.09	
9	11	BETTICHE Amina	ALG	1987	12	4:18.55	SB
10	311	BAKRACI Gresa	KOS	1995	2	4:27.76	
11	21	REFFAS Abir	ALG	1997	3	4:28.97	SB

### NOT RANKED

82	CHARALAMBOUS Thalía	CYP	1989	8	DNS
85	EVANGELIDOU Natalia	CYP	1991	7	DNS
122	GARCIA ALONSO Marta	ESP	1998	4	DNS
444	MECHAAL Emine Hatun	TUR	1995	5	DNS

### Intermediate point leaders (Bib and Time):

400 m :	152	1:10.72
800 m :	152	2:22.32
1200 m :	247	3:28.05

Details: Start time:18:50 Temperature:+26°C Humidity:75%

### Legend

* = Caution	DNF = Did Not Finish
DNS = Did Not Start	DQ = Disqualified
ORD = Order	SB = Season's Best

Oran 30 Juin - 3 Juillet

ATHW1500M-----FNL-000100--\_73G 1.0 Data Processing and Timing by Microplus - www.microplustiming.com

1



## RESULTS

RANK	BIB	SURNAME & NAME	NOC	DATE OF BIRTH	ORD	TIME
WR	14:06.62	GIDEY Letesenbet	1998	ETH	VALENCIA	07 OCT 2020
CR	15:00.69	BRUNET Roberta	1997	ITA	Bari	

### As of 02/07/2022 at 20:57

1	438	CAN Yasemin	TUR	1996	5	15:23.47	
2	332	TAHIRI Rahma	MAR	1998	9	15:56.36	
3	160	HADJI Leila	FRA	1998	4	16:05.54	
4	328	OUAZIZ Ikram	MAR	1999	6	16:05.96	PB
5	220	MARINAKOU Anastasia Pana	GRE	1996	8	16:07.12	
6	26	YAHYI Nawal	ALG	1991	13	16:08.52	
7	268	SELVA Giovanna	ITA		11	16:08.71	
8	444	MECHAAL Emine Hatun	TUR	1995	7	16:18.07	
9	5	AIT SALEM Souad	ALG	1979	1	16:21.60	
10	356	SCHEMBRI Roberta	MLT	1990	12	17:37.15	

### NOT RANKED

122	GARCIA ALONSO Marta	ESP	1998	3	DNS
329	QALLOUJ Hanane	MAR	1992	2	DNS
82	CHARALAMBOUS Thalia	CYP	1989	10	DNF

### Intermediate point leaders (Bib and Time):

1000 m :	438	3:09.12
2000 m :	438	6:08.02
3000 m :	438	9:11.27
4000 m :	438	12:18.39

### Legend

* = Caution	DNF = Did Not Finish
DNS = Did Not Start	DQ = Disqualified
ORD = Order	PB = Personal Best

Oran 30 Juin - 3 Juillet

ATHW5000M-----FNL-000100--\_73G 1.0 Data Processing and Timing by Microplus - www.microplustiming.com

1



## RESULTS

RANK	BIB	SURNAME & NAME	NOC	DATE OF BIRTH	ORD	TIME
WR		1:02:52 GIDEY Letesenbet	1998	ETH	VALENCIA	24 OCT 2021
CR		1:11:00 STANEO Valeria	2013	ITA	Mersin	29 JUN 2013

### As of 01/07/2022 at 9:44

1	251	EPIS Giovanna	ITA	11 OCT 1988	6	1:13:47
2	329	QALLOUJ Hanane	MAR	01 FEB 1992	2	1:13:53
3	323	EL MOUKIM Rkia	MAR	22 FEB 1988	7	1:14:05
4	441	ERDOGAN Meryem	TUR	24 APR 1990	9	1:14:11
5	177	SIERACKI Margaux	FRA	17 JUN 1999	3	1:14:16
6	162	JULIEN Melody	FRA	13 MAY 1999	5	1:15:39
7	256	LONEDO Rebecca	ITA	05 DEC 1996	13	1:15:49
8	174	ROLLIN Meline	FRA	17 JUN 1998	8	1:17:08
9	9	BENDERBAL Malika	ALG	03 JUL 1983	1	1:17:38
10	5	AIT SALEM Souad	ALG	06 JAN 1979	10	1:18:24
11	354	BEZZINA Lisa Marie	MLT	05 NOV 1979	11	1:28:02

### NOT RANKED

26	YAHY Nawal	ALG	09 SEP 1991	12	DNF
----	------------	-----	-------------	----	-----

### Intermediate point leaders (Bib and Time):

Details: Start time: 8:00 Temperature: +24°C Humidity: 74%

\*Bib nr.480 Carnicelli Sara (Vat) - time 1:17.21

### Legend

* = Caution	DNF = Did Not Finish
DNS = Did Not Start	DQ = Disqualified
ORD = Order	

Oran 30 Juin - 3 Juillet

ATHWMARATHON-----FNL-000100--\_73K Data Processing and Timing by Microplus - www.microplustiming.com

1



Complexe Olympique - Grand Stade  
Athletic  
Women's 3000 m Steeplechase - Final



RESULTS

RANK	BIB	SURNAME & NAME	NOC	DATE OF BIRTH	ORD	TIME
WR	8:44.32	CHEPKOECH Beatrice	1991	KEN	MONACO	20 JUL 2018
CR	9:27.73	GEGA Luiza	2018	ALB	Tarragona	28 JUN 2018

As of 01/07/2022 at 19:58

1	1	GEGA Luiza	ALB	1988	5	9:14.29	PB
2	423	BOUZAYANI Marwa	TUN	1997	10	9:29.11	
3	328	OUAZIZ Ikram	MAR	1999	9	9:32.87	PB
4	11	BETTICHE Amina	ALG	1987	8	9:37.18	SB
5	261	MERLO Martina	ITA	1993	6	9:38.84	SB
6	172	RENOUARD Flavie	FRA		3	9:52.53	
7	164	LEMITRE Alexa	FRA	1998	11	9:52.65	SB
8	325	ES-SEQALLY Sabah	MAR	1997	1	9:54.81	PB
9	133	VINARAS OTEO Clara	ESP	1993	2	10:12.34	
10	242	ARNAUDO Anna	ITA		4	10:22.46	

NOT RANKED

443	GUVENC Tugba	TUR	1994	7	DNF
-----	--------------	-----	------	---	-----

Intermediate point leaders (Bib and Time):

1000 m :	1	3:03.73
2000 m :	1	6:07.99

Details: Start time:19:45 Temperature:+26°C Humidity:80%

Legend

* = Caution	DNF = Did Not Finish
DNS = Did Not Start	DQ = Disqualified
ORD = Order	PB = Personal Best
SB = Season's Best	

Oran 30 Juin - 3 Juillet

ATHW3000MST-----FNL-000100--\_73G 1.0 Data Processing and Timing by Microplus - www.microplustiming.com

1



## RESULTS

RANK	BIB	SURNAME & NAME	NOC	DATE OF BIRTH	LANE	R.T.	TIME
WR	12.20	HARRISON Kendra	1992 USA	LONDON			22 JUL 2016
CR	12.82	GIRARD Patricia	2001 FRA	Rades			12 SEP 2001

As of 03/07/2022 at 19:24

(Wind: +1.0 m/s)

RANK	BIB	SURNAME & NAME	NOC	DATE OF BIRTH	LANE	R.T.	TIME	REMARKS
1	151	COMPPPER Solenn	FRA	14 MAR 1995	6	0.166	<b>12.92</b>	PB
2	263	MOSETTI Nicla	ITA	24 AUG 1997	3	0.165	<b>13.22</b>	
3	221	PESIRIDOU Elisavet	GRE	12 FEB 1992	7	0.164	<b>13.23</b>	
4	371	DA COSTA CASSANDRA BARBO	POR	28 FEB 1995	8	0.185	<b>13.30</b>	
5	413	LUKIC Anja	SRB	30 MAY 1999	1	0.186	<b>13.40</b>	
6	149	VENDOME Lea	FRA	15 SEP 2002	5	0.173	<b>13.44</b>	
7	246	CARRARO Elena	ITA	03 JAN 2001	4	0.181	<b>13.67</b>	

## NOT RANKED

435	AYAZ Seval	TUR	25 SEP 2000	2			<b>DQ</b>	16.8
-----	------------	-----	-------------	---	--	--	-----------	------

Details: Start time:19:20 Temperature:+25°C Humidity:80%

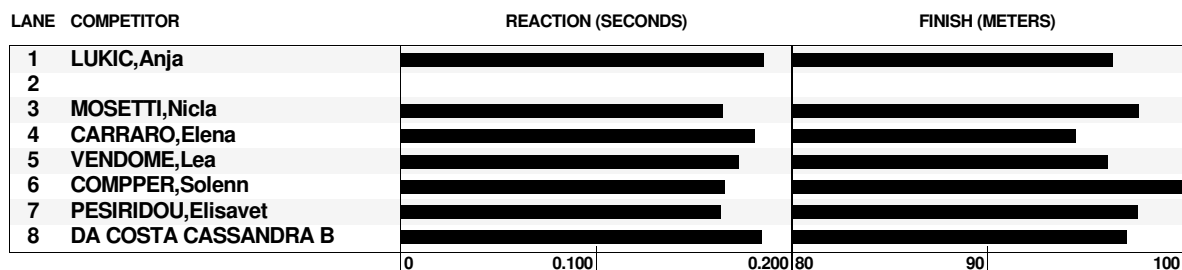

### Legend

DNF = Did Not Finish      DNS = Did Not Start  
DQ = Disqualified      Fn = False Start  
PB = Personal Best      R.T. = Reaction



## RESULTS

RANK	BIB	SURNAME & NAME	NOC	DATE OF BIRTH	LANE	R.T.	TIME
WR	12.20	HARRISON Kendra	USA	1992	LONDON		22 JUL 2016
CR	12.82	GIRARD Patricia	FRA	2001	Rades		12 SEP 2001

As of 02/07/2022 at 18:21

(Wind: +0.5 m/s)

RANK	BIB	SURNAME & NAME	NOC	DATE OF BIRTH	LANE	R.T.	TIME
1	246	CARRARO Elena	ITA	03 JAN 2001	5	0.191	13.15 Q
2	149	VENDOME Lea	FRA	15 SEP 2002	8	0.182	13.29 Q
3	371	DA COSTA CASSANDRA BARBO	POR	28 FEB 1995	4	0.160	13.47 Q
4	88	GEORGIU Dafni	CYP	18 AUG 1999	7	0.183	13.56
5	75	LONCAREK Ivana	CRO	08 APR 1991	2	0.183	13.69
6	109	AHMED Lina	EGY	11 MAR 1997	3	0.345	13.82 SB
7	17	HAMEL Rahil	ALG	21 JUL 2002	6	0.245	14.02

Qualification: First 3 in each heat (Q) and 2 fastest (q) to Final

Details:

Start time:18:20

Temperature:+26°C

Humidity:65%

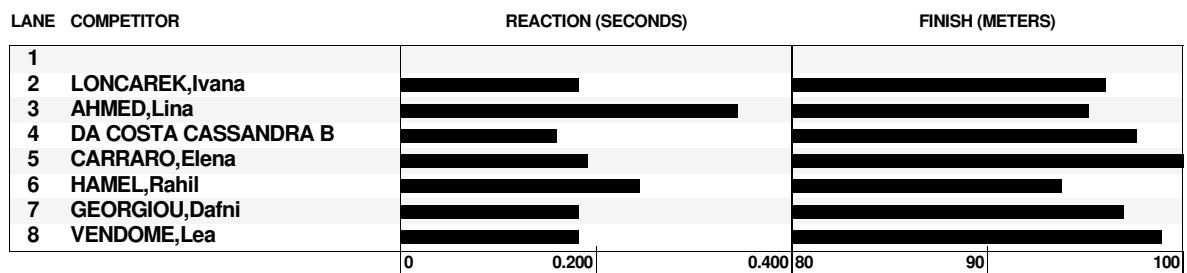

### Legend

DNF = Did Not Finish  
DQ = Disqualified  
R.T. = Reaction

DNS = Did Not Start  
Fn = False Start  
SB = Season's Best

Oran 30 Juin - 3 Juillet

ATHW100MHURD-----RND1000100--\_73A Data Processing and Timing by Microplus - www.microplustiming.com

1





## RESULTS

RANK	BIB	SURNAME & NAME	NOC	DATE OF BIRTH	LANE	R.T.	TIME
WR	12.20	HARRISON Kendra	USA	1992	LONDON		22 JUL 2016
CR	12.82	GIRARD Patricia	FRA	2001	Rades		12 SEP 2001

As of 02/07/2022 at 18:28

(Wind: +1.0 m/s)

RANK	BIB	SURNAME & NAME	NOC	DATE OF BIRTH	LANE	R.T.	TIME	MARKS
1	263	MOSETTI Nicla	ITA	24 AUG 1997	6	0.130	13.02	Q PB
2	151	COMPPEP Solenn	FRA	14 MAR 1995	8	0.175	13.12	Q
3	221	PESIRIDOU Elisavet	GRE	12 FEB 1992	2	0.152	13.17	Q SB
4	435	AYAZ Sevval	TUR	25 SEP 2000	3	0.124	13.22	q PB
5	413	LUKIC Anja	SRB	30 MAY 1999	5	0.187	13.26	q PB
6	130	RADSMA AGUILAR Aitana	ESP	31 JAN 2002	4	0.179	13.39	SB
7	84	CHRISTOFI Natalia	CYP	10 FEB 1997	7	0.148	13.48	

Qualification: First 3 in each heat (Q) and 2 fastest (q) to Final

Details:

Start time:18:27

Temperature:+26°C

Humidity:65%

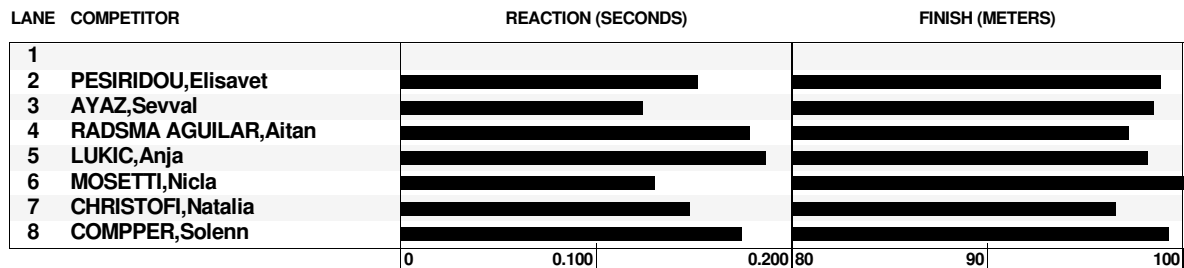

### Legend

DNF = Did Not Finish  
DQ = Disqualified  
PB = Personal Best  
SB = Season's Best

DNS = Did Not Start  
Fn = False Start  
R.T. = Reaction

Oran 30 Juin - 3 Juillet

ATHW100MHURD-----RND1000100--\_73A Data Processing and Timing by Microplus - www.microplustiming.com

2



## SUMMARY

RANK	BIB	SURNAME & NAME	NOC	DATE OF BIRTH	HEAT	LANE	RANK	WIND	TIME		
<b>WR</b>		<b>12.20 HARRISON Kendra</b>		1992 USA	LONDON						22 JUL 2016
<b>CR</b>		<b>12.82 GIRARD Patricia</b>		2001 FRA	Rades						12 SEP 2001
1	263	<b>MOSETTI Nicla</b>	ITA	24 AUG 1997	2	6	1	+1.0	<b>13.02</b>	Q	PB
2	151	<b>COMPPE Solenn</b>	FRA	14 MAR 1995	2	8	2	+1.0	<b>13.12</b>	Q	
3	246	<b>CARRARO Elena</b>	ITA	03 JAN 2001	1	5	1	+0.5	<b>13.15</b>	Q	
4	221	<b>PESIRIDOU Elisavet</b>	GRE	12 FEB 1992	2	2	3	+1.0	<b>13.17</b>	Q	SB
5	435	<b>AYAZ Sevval</b>	TUR	25 SEP 2000	2	3	4	+1.0	<b>13.22</b>	q	PB
6	413	<b>LUKIC Anja</b>	SRB	30 MAY 1999	2	5	5	+1.0	<b>13.26</b>	q	PB
7	149	<b>VENDOME Lea</b>	FRA	15 SEP 2002	1	8	2	+0.5	<b>13.29</b>	Q	
8	130	<b>RADAMA AGUILAR Aitana</b>	ESP	31 JAN 2002	2	4	6	+1.0	<b>13.39</b>		SB
9	371	<b>DA COSTA CASSANDRA BARBO</b>	POR	28 FEB 1995	1	4	3	+0.5	<b>13.47</b>	Q	
10	84	<b>CHRISTOFI Natalia</b>	CYP	10 FEB 1997	2	7	7	+1.0	<b>13.48</b>		
11	88	<b>GEORGIU Dafni</b>	CYP	18 AUG 1999	1	7	4	+0.5	<b>13.56</b>		
12	75	<b>LONCAREK Ivana</b>	CRO	08 APR 1991	1	2	5	+0.5	<b>13.69</b>		
13	109	<b>AHMED Lina</b>	EGY	11 MAR 1997	1	3	6	+0.5	<b>13.82</b>		SB
14	17	<b>HAMEL Rahil</b>	ALG	21 JUL 2002	1	6	7	+0.5	<b>14.02</b>		

Qualification: First 3 in each heat (Q) and 2 fastest (q) to Final

### Legend

DNF = Did Not Finish  
DQ = Disqualified  
PB = Personal Best  
SB = Season's Best

DNS = Did Not Start  
Fn = False Start  
R.T. = Reaction

Oran 30 Juin - 3 Juillet

ATHW100MHURD-----RND1-----\_74A 1.0Data Processing and Timing by Microplus - www.microplustiming.com

1



## RESULTS

RANK	BIB	SURNAME & NAME	NOC	DATE OF BIRTH	LANE	R.T.	TIME
WR	51.41	MCLAUGHLIN Sydney	1999	USA	EUGENE		25 JUN 2022
CR	55.01	BIDOUANE Nezha	1997	MAR	Bari		

### As of 01/07/2022 at 19:33

RANK	BIB	SURNAME & NAME	NOC	DATE OF BIRTH	LANE	R.T.	TIME	MARKS
1	267	SARTORI Rebecca	ITA	22 MAY 1997	4	0.214	55.75	
2	176	SERI Camille	FRA	01 MAY 1999	6	0.209	56.01	
3	324	ENNADI Noura	MAR	05 APR 1999	5	0.395	56.45	PB
4	219	GNAFAKI Dimitra	GRE	09 JUL 1997	2	0.177	56.55	PB
5	378	MENDES BARBOSA Vera L.	POR	13 JAN 1989	7	0.180	56.82	
6	123	GARCIA SANCHEZ Carla	ESP	09 OCT 2001	8	0.190	56.83	
7	264	MURARO Alice	ITA	14 AUG 2000	3	0.223	57.12	PB

### NOT RANKED

397	ZUPIN Agata	SLO	17 MAR 1998	1	DNS
-----	-------------	-----	-------------	---	-----

Details: Start time:19:30 Temperature:+26°C Humidity:80%

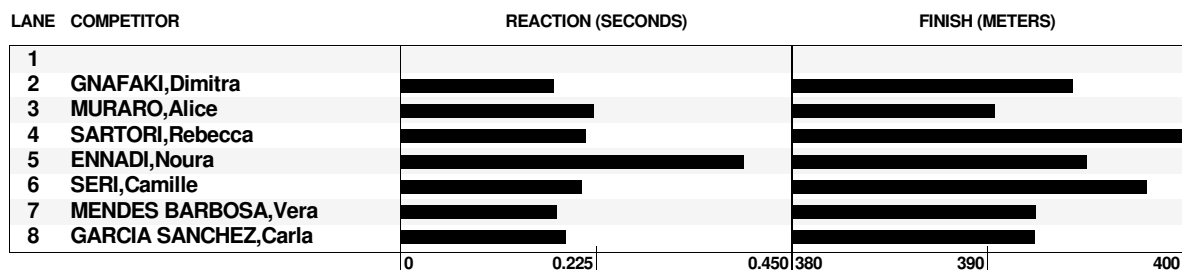

#### Legend

DNF = Did Not Finish  
DQ = Disqualified  
PB = Personal Best  
DNS = Did Not Start  
Fn = False Start  
R.T. = Reaction

Oran 30 Juin - 3 Juillet

ATHW400MHURD-----FNL-000100--\_73A 1 Data Processing and Timing by Microplus - www.microplustiming.com

1



## RESULTS

RANK	BIB	SURNAME & NAME	NOC	DATE OF BIRTH	LANE	R.T.	TIME
WR	51.41	MCLAUGHLIN Sydney	1999	USA	EUGENE		25 JUN 2022
CR	55.01	BIDOUANE Nezha	1997	MAR	Bari		

### As of 30/06/2022 at 18:23

RANK	BIB	SURNAME & NAME	NOC	DATE OF BIRTH	LANE	R.T.	TIME
1	176	SERI Camille	FRA	01 MAY 1999	2	0.202	56.94 Q
2	264	MURARO Alice	ITA	14 AUG 2000	8	0.379	57.20 Q
3	123	GARCIA SANCHEZ Carla	ESP	09 OCT 2001	3	0.195	57.30 Q
4	219	GNAFAKI Dimitra	GRE	09 JUL 1997	5	0.261	57.53 q
5	350	ISLAMI BAFTIRI Drita	MKD	01 AUG 1996	4	0.267	59.16
6	367	GASTAUD Marie-charlotte	MON	30 NOV 1999	7	0.391	1:04.34

### NOT RANKED

159	GREBO Shana	FRA	09 NOV 2000	6	DNS
-----	-------------	-----	-------------	---	-----

Qualification: First 3 in each heat (Q) and 2 fastest (q) to Final

Details: Start time:18:20 Temperature:+25°C Humidity:80%

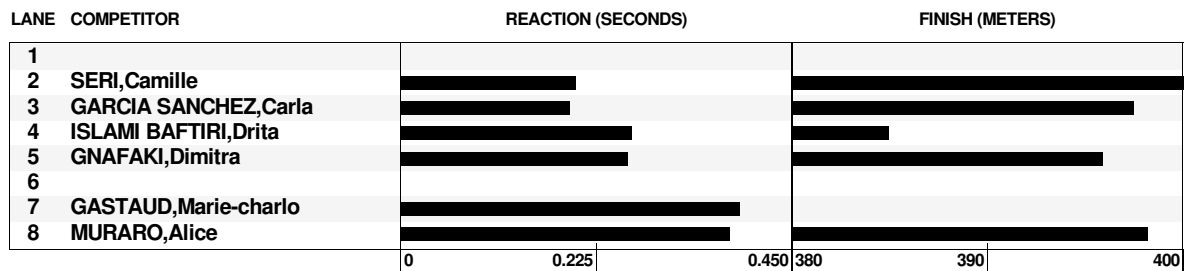

### Legend

DNF = Did Not Finish	DNS = Did Not Start
DQ = Disqualified	Fn = False Start
R.T. = Reaction	

Oran 30 Juin - 3 Juillet

ATHW400MHURD-----RND1000100--\_73A Data Processing and Timing by Microplus - www.microplustiming.com

1



## RESULTS

RANK	BIB	SURNAME & NAME	NOC	DATE OF BIRTH	LANE	R.T.	TIME
WR	51.41	MCLAUGHLIN Sydney	1999	USA	EUGENE		25 JUN 2022
CR	55.01	BIDOUANE Nezha	1997	MAR	Bari		

### As of 30/06/2022 at 18:30

1	267	SARTORI Rebecca	ITA	22 MAY 1997	6	0.208	56.55 Q
2	324	ENNADI Noura	MAR	05 APR 1999	8	0.371	56.64 Q
3	378	MENDES BARBOSA Vera L.	POR	13 JAN 1989	4	0.382	57.15 Q
4	397	ZUPIN Agata	SLO	17 MAR 1998	3	0.202	58.06 q
5	10	BENHADJA Loubna	ALG	11 FEB 2001	5	0.207	1:00.30
6	406	BERTI Beatrice	SMR	06 DEC 1999	2	0.350	1:02.81
7	62	LUQUE MAESTRE Bruna	AND	28 DEC 2002	7	0.211	1:04.43

Qualification: First 3 in each heat (Q) and 2 fastest (q) to Final

Details: Start time:18:28 Temperature:+25°C Humidity:80%

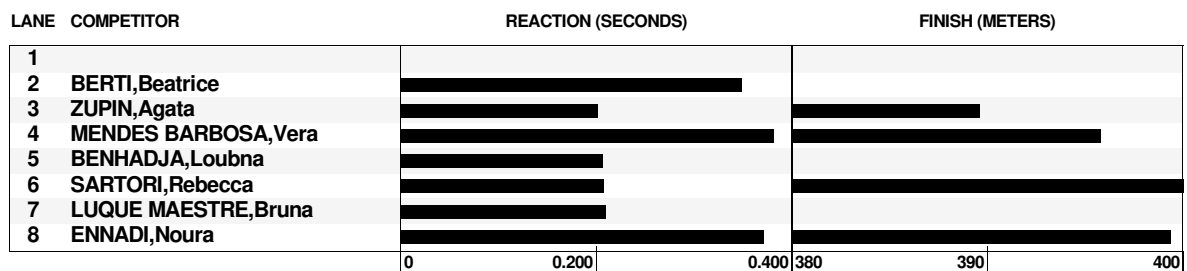

### Legend

DNF = Did Not Finish  
DQ = Disqualified  
R.T. = Reaction  
DNS = Did Not Start  
Fn = False Start

Oran 30 Juin - 3 Juillet

ATHW400MHURD-----RND1000100--\_73A Data Processing and Timing by Microplus - www.microplustiming.com

2



## SUMMARY

RANK	BIB	SURNAME & NAME	NOC	DATE OF BIRTH	HEAT	LANE	RANK	WIND	TIME
WR	51.41	MCLAUGHLIN Sydney	1999	USA	EUGENE				25 JUN 2022
CR	55.01	BIDOUANE Nezha	1997	MAR	Bari				
1	267	SARTORI Rebecca	ITA	22 MAY 1997	2	6	1		56.55 Q
2	324	ENNADI Noura	MAR	05 APR 1999	2	8	2		56.64 Q
3	176	SERI Camille	FRA	01 MAY 1999	1	2	1		56.94 Q
4	378	MENDES BARBOSA Vera L.	POR	13 JAN 1989	2	4	3		57.15 Q
5	264	MURARO Alice	ITA	14 AUG 2000	1	8	2		57.20 Q
6	123	GARCIA SANCHEZ Carla	ESP	09 OCT 2001	1	3	3		57.30 Q
7	219	GNAFAKI Dimitra	GRE	09 JUL 1997	1	5	4		57.53 q
8	397	ZUPIN Agata	SLO	17 MAR 1998	2	3	4		58.06 q
9	350	ISLAMI BAFTIRI Drita	MKD	01 AUG 1996	1	4	5		59.16
10	10	BENHADJA Loubna	ALG	11 FEB 2001	2	5	5		1:00.30
11	406	BERTI Beatrice	SMR	06 DEC 1999	2	2	6		1:02.81
12	367	GASTAUD Marie-charlotte	MON	30 NOV 1999	1	7	6		1:04.34
13	62	LUQUE MAESTRE Bruna	AND	28 DEC 2002	2	7	7		1:04.43

## NOT RANKED

159	GREBO Shana	FRA	09 NOV 2000	1	6				DNS
-----	-------------	-----	-------------	---	---	--	--	--	-----

Qualification: First 3 in each heat (Q) and 2 fastest (q) to Final

### Legend

DNF = Did Not Finish  
DQ = Disqualified  
R.T. = Reaction

DNS = Did Not Start  
Fn = False Start

Oran 30 Juin - 3 Juillet

ATHW400MHURD-----RND1-----\_74A 1.0Data Processing and Timing by Microplus - www.microplustiming.com

1



## RESULTS

RANK BIB SURNAME & NAME NOC ORD DATE OF BIRTH 1.67 1.72 1.77 1.81 1.84 1.87 1.90 1.92 1.96 RESULT

WR	2.09	KOSTADINOVA Stefka	1965	BUL	ROMA	30 AUG 1987
CR	1.98	SIMEONI Sara	1979	ITA	Split	1979

### As of 03/07/2022 at 19:38

RANK	BIB	SURNAME & NAME	NOC	ORD	1.67	1.72	1.77	1.81	1.84	1.87	1.90	1.92	1.96	RESULT
1	363	VUKOVIC Marija	MNE	3	-	-	-	O	-	O	XO	O	XXX	1.92
		21 JAN 1992												
2	218	GKOUSIN OR GUSIN Tatiana	GRE	1	-	-	-	O	O	XO	O	XXX		1.90 SB
		26 JAN 1994												
3	262	MORARA Marta	ITA	7	-	O	O	O	XXO	O	XXX			1.87 PB
		26 DEC 1999												
4	217	CHRISTOGEORGOU Eleftheri	GRE	8	-	O	O	O	O	XXO	XXX			1.87
		19 AUG 1998												
5	158	GICQUEL Solene	FRA	6	-	-	O	O	O	XXX				1.84
		01 DEC 1994												
5	331	SIBA Rhizlane	MAR	11	-	O	O	O	O	XXX				1.84
		29 FEB 1996												
5	446	SAVASKAN Buse	TUR	10	-	-	O	O	O	XXX				1.84
		24 FEB 1999												
8	253	FURLANI Erika	ITA	4	-	-	O	O	XXO	XXX				1.84
		02 JAN 1996												
9	83	CHARALAMBOUS Despoina	CYP	2	O	O	O	XXX						1.77
		22 MAY 2000												
9	89	IOANNIDOU Styliana	CYP	9	O	O	O	XXX						1.77
		17 DEC 2003												
11	166	MAXWELL-QUINOL Laureen	FRA	12	-	-	XO	XXX						1.77
		23 MAY 2002												
12	22	REZIK Darina Hadil	ALG	5	O	XXO	XXX							1.72
		27 JUN 2003												
13	8	BEN HADJA Afaf	ALG	13	O	XXX								1.67
		10 FEB 1999												

#### Details:

Start time:18:00  
Finish Time:19:32

Temperature:+27°C  
Temperature:+25°C

Humidity:70%  
Humidity:80%

#### Legend

- = Did Not Attempt  
DNS = Did Not Start  
NM = No Result  
ORD = Order  
SB = Season's Best

DNF = Did Not Finish  
DQ = Disqualified  
O = Cleared  
PB = Personal Best  
X = Failed

Oran 30 Juin - 3 Juillet

ATHHIGHJUMP-----FNL-000100--\_73M 10 Data Processing and Timing by Microplus - www.microplustiming.com

1



## RESULTS

RANK BIB SURNAME & NAME NOC ORD - 1 - - 2 - - 3 - - 4 - - 5 - - 6 - RESULT WIND  
DATE OF BIRTH

WR	7.52	CHISTYAKOVA Galina	1962	URS	LENINGRAD	11 JUN 1988
CR	6.99	SPANOVIC Ivana	2018	SRB	Tarragona	27 JUN 2018

### As of 01/07/2022 at 20:16

RANK	BIB	SURNAME & NAME	NOC	ORD	1	2	3	4	5	6	7	8	9	10	11	12	13	RESULT	WIND
1	411	GARDASEVIC Milica	SRB	9	6.53	6.65	6.64	X	X	6.67	<b>6.67</b>								
					+0.9	+0.9	+0.8	0.0	-0.3	-1.1	-1.1								
2	112	OWIS Esraa	EGY	8	6.30	6.31	6.54	6.40	6.29	6.37	<b>6.54</b>								
					+0.4	-1.1	+0.5	+0.5	-0.8	-0.4	+0.5								
3	379	TAVARES DA VEIGA Evelise	POR	6	6.15	6.54	6.39	X	X	6.21	<b>6.54</b>								
					-0.3	-1.1	+0.6	+0.7	-0.9	+0.1	-1.1								
4	392	FILIPIC Neja	SLO	7	X	6.28	6.09	6.29	6.31	6.45	<b>6.45</b>								
					-0.7	+0.7	+0.3	-0.6	+0.7	-0.6	-0.6								
5	165	MAUCHANT Tiphaine	FRA	13	6.35	6.44	6.26	6.20	6.19	6.41	<b>6.44</b>	SB							
					+0.4	+1.0	+0.8	+0.7	-0.1	+0.5	+1.0								
6	216	CHAITIDOU Vasiliki	GRE	4	6.27	6.34	6.16	6.19	6.20	6.06	<b>6.34</b>								
					+0.9	-0.1	+1.1	+0.6	+0.7	-1.1	-0.1								
7	87	FOTOPOULOU Filippa	CYP	1	6.10	5.99	6.23	6.07	6.34	6.11	<b>6.34</b>								
					+0.9	-0.3	-0.8	-0.8	+0.7	-0.6	+0.7								
8	270	STRATI Laura	ITA	12	6.00	X	6.14	6.13	6.03	5.68	<b>6.14</b>								
					+0.5	+0.7	+0.7	-1.0	-0.1	-0.6	+0.7								
9	168	OUREGA Marie-jeanne	FRA	5	5.98	6.11	6.07				<b>6.11</b>								
					-0.1	-0.9	+0.5				-0.9								
10	7	BELABIOD Tahani Roumaiss	ALG	11	6.06	5.93	X				<b>6.06</b>								
					+0.3	+0.7	+0.4				+0.3								
11	326	LAJDOUD Yousra	MAR	10	6.06	X	X				<b>6.06</b>								
					+1.1	+0.2	+0.6				+1.1								
12	128	MITXELENA BALERDI Irati	ESP	3	5.87	6.03	6.01				<b>6.03</b>								
					+0.1	-1.3	+1.0				-1.3								
13	24	SELMi Kaoutar	ALG	2	5.86	5.85	5.81				<b>5.86</b>								
					+0.5	+0.6	-0.1				+0.5								

Starting order	1	2	3	4	5	6	7	8	9	10	11	12	13		
	87	24	128	216	168	379	392	112	411	326	7	270	165		

**Details:**

Start time:18:30  
Finish Time:20:15

Temperature:+26°C  
Temperature:+25°C

Humidity:75%  
Humidity:85%

**Legend**

- = Did Not Attempt	DNF = Did Not Finish
DNS = Did Not Start	DQ = Disqualified
NM = No Result	ORD = Order
SB = Season's Best	X = Failed





## RESULTS

RANK BIB SURNAME & NAME NOC ORD - 1 - - 2 - - 3 - - 4 - - 5 - - 6 - RESULT WIND  
DATE OF BIRTH

WR	15.67	ROJAS Yulimar	1995	VEN	TOKYO	01 AUG 2021
CR	14.98	RAHOULI Baya	2005	ALG	Almeria	01 JUL 2005

### As of 02/07/2022 at 20:29

RANK	BIB	SURNAME & NAME	NOC	ORD	1	2	3	4	5	6	7	8	9	RESULT	WIND
1	392	FILIPIC Neja	SLO	2	X	14.15	X	14.16	X	14.05	<b>14.16</b>				
					-0.1	+0.2	+0.8	+1.1	+0.7	+1.6	+1.1				
2	439	DANISMAZ Tugba	TUR	8	13.67	13.74	14.02	14.05	13.92	X	<b>14.05</b>				
					0.0	-0.9	+0.2	+0.8	+0.4	+0.9	+0.8				
3	121	EBOSELE EBOSELE Tessy	ESP	9	12.80	13.12	12.47	X	13.42	13.63	<b>13.63</b>				
					+1.1	-0.2	+0.9	+0.7	+0.9	+0.5	+0.5				
4	148	ASSANI ISSOUF Jeanine	FRA	4	13.53	13.51	X	13.56	X	13.44	<b>13.56</b>				
					+0.3	+0.5	-0.3	+0.7	+0.8	+0.5	+0.7				
5	394	PEPELNAK Eva	SLO	6	13.36	13.27	X	13.25	13.21	13.21	<b>13.36</b>				
					+0.6	+0.1	+0.3	+0.3	+0.6	+1.0	+0.6				
6	379	TAVARES DA VEIGA Evelise	POR	7	13.20	X	X	13.31	X	X	<b>13.31</b>				
					+0.8	0.0	0.0	+1.1	+0.4	+0.9	+1.1				
7	24	SELMI Kaoutar	ALG	1	12.53	X	13.22	13.28	12.97	13.09	<b>13.28</b>				PB
					-0.3	+0.5	-0.4	+1.1	+1.0	+0.9	+1.1				
8	18	HARKAS Wissal	ALG	5	X	X	13.02	12.67	X	12.32	<b>13.02</b>				PB
					+0.7	+0.5	0.0	+0.9	+0.5	+0.6	0.0				
9	355	PACE Rachela	MLT	3	X	12.22	X				<b>12.22</b>				
					+0.8	+0.3	+0.4				+0.3				

Starting order	1	2	3	4	5	6	7	8	9						
	24	392	355	148	18	394	379	439	121						

#### Details:

Start time:19:01  
Finish Time:20:28

Temperature:+26°C  
Temperature:+25°C

Humidity:65%  
Humidity:75%

#### Legend

- = Did Not Attempt  
DNS = Did Not Start  
NM = No Result  
PB = Personal Best  
DNF = Did Not Finish  
DQ = Disqualified  
ORD = Order  
X = Failed

Oran 30 Juin - 3 Juillet

ATHWTRPLJUMP-----FNL-000100--\_730 1 Data Processing and Timing by Microplus - www.microplustiming.com

1



## RESULTS

RANK	BIB	SURNAME & NAME	NOC	DATE OF BIRTH	RESULT	
WR	76.80	REINSCH Gabriele	1963	GDR	NEUBRANDENBU	09 JUL 1988
CR	66.46	PERKOVIC Sandra	2018	CRO	Tarragona	28 JUN 2018

### As of 30/06/2022 at 21:34

1	76	<b>TOLJ Marija</b>	CRO	29 NOV 1999	<b>64.71</b>
2	374	<b>DA SILVA CA Liliana</b>	POR	05 NOV 1986	<b>63.62</b>
3	437	<b>BECEREK Ozlem</b>	TUR	22 APR 2002	<b>61.96</b>
4	271	<b>STRUMILLO Stefania</b>	ITA	14 OCT 1989	<b>55.93</b>
5	91	<b>LADA Androniki</b>	CYP	19 APR 1991	<b>55.84</b>
6	252	<b>FORTUNA Diletta</b>	ITA	03 MAR 2001	<b>50.98</b>
7	13	<b>BOUNAB Nabila</b>	ALG	07 FEB 1994	<b>42.19</b>

Starting order	1	2	3	4	5	6	7							
Initial	252	76	91	271	374	13	437							
4th and 5th attempts	252	13	91	271	437	374	76							
6th attempt	13	252	91	271	437	374	76							

#### Details:

Start time:19:45  
Finish Time:20:50

Temperature:+23°C  
Temperature:+22°C

Humidity:80%  
Humidity:80%

### As of 30/06/2022 at 21:34

RANK	BIB	SURNAME & NAME	NOC	ORD	- 1 -	- 2 -	- 3 -	- 4 -	- 5 -	- 6 -	RESULT
			DATE OF BIRTH								
6	252	<b>FORTUNA Diletta</b>	ITA	1	X	X	X	X	50.98	X	<b>50.98</b>
1	76	<b>TOLJ Marija</b>	CRO	2	59.15	57.70	64.71	60.86	62.29	X	<b>64.71</b>
5	91	<b>LADA Androniki</b>	CYP	3	-	51.16	53.60	51.76	55.84	54.00	<b>55.84</b>
4	271	<b>STRUMILLO Stefania</b>	ITA	4	55.55	52.96	55.93	X	53.70	54.84	<b>55.93</b>
2	374	<b>DA SILVA CA Liliana</b>	POR	5	61.91	63.05	X	62.53	63.62	X	<b>63.62</b>
7	13	<b>BOUNAB Nabila</b>	ALG	6	41.63	X	41.64	42.19	X	X	<b>42.19</b>
3	437	<b>BECEREK Ozlem</b>	TUR	7	61.96	X	X	X	X	X	<b>61.96</b>

\* measuring not done correctly (Referee decision based on Video)

#### Legend

- = Did Not Attempt  
DNS = Did Not Start  
NM = No Result  
X = Failed

DNF = Did Not Finish  
DQ = Disqualified  
ORD = Order

Oran 30 Juin - 3 Juillet

ATHWDISCUS-----FNL-000100--\_73R 1.0Data Processing and Timing by Microplus - www.microplustiming.com

1



## RESULTS

RANK BIB SURNAME & NAME NOC ORD - 1 - - 2 - - 3 - - 4 - - 5 - - 6 - RESULT  
DATE OF BIRTH

WR	82.98	WLODARCZYK Anita	1985	POL	WARSZAWA	28 AUG 2016
CR	73.67	TAVERNIER Alexandra	2018	FRA	Tarragona	27 JUN 2018

### As of 30/06/2022 at 21:10

RANK	BIB	SURNAME & NAME	NOC	ORD	1	2	3	4	5	6	7	8	9	10	11	RESULT
1	131	REDONDO MORA Laura	ESP	7	X	68.12	X	X	69.37	69.97	<b>69.97</b>					
		03 JUL 1988														
2	445	SALMAN Kivilcim Kaya	TUR	11	X	68.17	69.13	69.82	68.67	68.17	<b>69.82</b>	SB				
		27 MAR 1992														
3	14	BOUZEBRA Zouina	ALG	5	62.63	63.21	65.41	65.45	63.78	59.60	<b>65.45</b>	PB				
		03 OCT 1990														
4	179	NGOMATEKE Xena	FRA	1	62.49	64.15	X	65.42	X	61.45	<b>65.42</b>					
		26 AUG 1998														
5	129	ODEH ODEH Osarumen	ESP	4	X	62.39	63.22	64.17	65.05	63.42	<b>65.05</b>					
		15 NOV 1995														
6	110	BARAKAT Rawan	EGY	6	61.57	63.93	63.70	64.28	62.70	63.37	<b>64.28</b>					
		17 JUL 2001														
7	266	PRINETTI ANZALAPYA Lucia	ITA	9	X	62.59	63.48	63.91	X	X	<b>63.91</b>					
		03 NOV 1997														
8	178	TAILLANDIER Lorelei	FRA	10	X	61.21	61.95	59.37	60.71	61.93	<b>61.95</b>					
		08 AUG 1991														
9	4	TATAR Zahra	ALG	3	61.35	55.84	61.93				<b>61.93</b>					
		30 NOV 1992														
10	258	MAFFO Nadia	ITA	2	61.82	X	59.67				<b>61.82</b>					
		06 JUN 1996														
11	90	KYRIAKOU Chrystalla	CYP	8	60.68	61.12	60.71				<b>61.12</b>					
		04 OCT 1996														

Starting order	1	2	3	4	5	6	7	8	9	10	11					
	179	258	4	129	14	110	131	90	266	178	445					

#### Details:

Start time:17:40  
Finish Time:19:05

Temperature:+24°C  
Temperature:+23°C

Humidity:80%  
Humidity:80%

#### Legend

- = Did Not Attempt	DNF = Did Not Finish
DNS = Did Not Start	DQ = Disqualified
NM = No Result	ORD = Order
PB = Personal Best	SB = Season's Best
X = Failed	

Oran 30 Juin - 3 Juillet

ATHWHAMMER-----FNL-000100--\_73R 1 Data Processing and Timing by Microplus - www.microplustiming.com

1



## RESULTS

RANK BIB SURNAME & NAME NOC ORD - 1 - - 2 - - 3 - - 4 - - 5 - - 6 - RESULT  
DATE OF BIRTH

WR	72.28	SPOTAKOVA Barbora	1981	CZE	STUTTGART	13 SEP 2008
CR	62.61	TSIOLAKOUDI Aggeliki	2005	GRE	Almeria	01 JUL 2005

### As of 02/07/2022 at 18:03

RANK	BIB	SURNAME & NAME	NOC	ORD	1	2	3	4	5	6	RESULT
1	415	VILAGOS Adriana	SRB	2	57.39	57.49	60.22	54.09	57.59	58.47	<b>60.22</b>
		02 JAN 2004									
2	448	TUGSUZ Eda	TUR	5	55.25	X	58.65	X	59.30	X	<b>59.30</b> SB
		27 MAR 1997									
3	167	MINARD Alizee	FRA	3	54.12	52.85	54.44	55.16	X	56.22	<b>56.22</b>
		06 MAY 1997									
4	442	ESRA Turkmen	TUR	4	55.78	55.26	56.03	X	X	X	<b>56.03</b>
		20 JAN 2002									
5	274	ZABARINO Sara	ITA	1	50.51	53.98	50.14	51.40	X	53.57	<b>53.98</b>
		01 AUG 1999									
6	223	VISCA Carolina	ITA	6	50.89	52.18	X	X	50.25	X	<b>52.18</b>
		31 MAY 2000									

Starting order	1	2	3	4	5	6								
	274	415	167	442	448	223								

#### Details:

Start time:18:03  
Finish Time:18:38

Temperature:+26°C  
Temperature:+26°C

Humidity:65%  
Humidity:65%

#### Legend

- = Did Not Attempt  
DNS = Did Not Start  
NM = No Result  
SB = Season's Best

DNF = Did Not Finish  
DQ = Disqualified  
ORD = Order  
X = Failed

Oran 30 Juin - 3 Juillet

ATHWJAVELIN-----FNL-000100--\_73R 1.0Data Processing and Timing by Microplus - www.microplustiming.com

1



Complexe Olympique - Grand Stade  
Athletic  
Women's 4 x 100 Relay - Final



**RESULTS**

RANK	BIB	TEAM	NOC	LANE	R.T.	TIME
WR	40.82	UNITED STATES	USA	LONDON		10 AUG 2012

As of 01/07/2022 at 20:13

1		<b>ITALY</b>	ITA	4	0.167	<b>43.68</b>
2		<b>FRANCE</b>	FRA	5	0.175	<b>44.63</b>
3		<b>CYPRUS</b>	CYP	6	0.183	<b>45.10</b>

**NOT RANKED**

		<b>PORTUGAL</b>		7		<b>DNS</b>
--	--	-----------------	--	---	--	------------

Details: Start time:20:10 Temperature:+25°C Humidity:85%

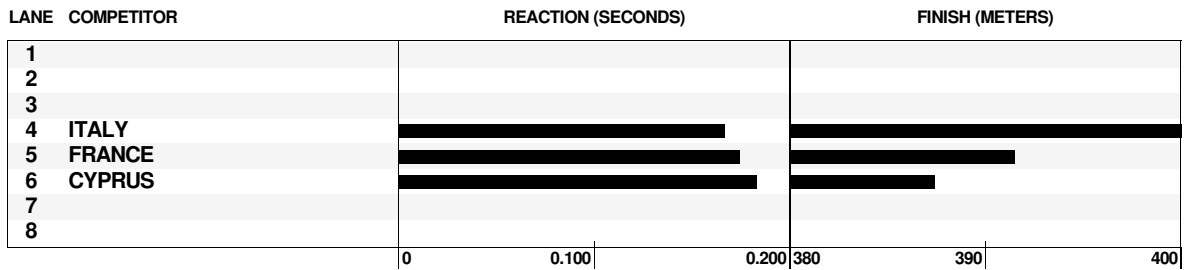

**Legend**

DNF = Did Not Finish      DNS = Did Not Start  
DQ = Disqualified      Fn = False Start  
R.T. = Reaction

Oran 30 Juin - 3 Juillet

ATHW4X100M-----FNL-000100--\_73E 1.0 Data Processing and Timing by Microplus - www.microplustiming.com



## RESULTS

RANK	BIB	TEAM	NOC	LANE	R.T.	TIME
WR		3:15.17	USSR	URS	SEOUL	01 OCT 1988
CR		3:28.08	ITALY	2018 ITA	Tarragona	30 JUN 2018

### As of 03/07/2022 at 20:10

RANK	TEAM	NOC	LANE	R.T.	TIME
1	<b>ITALY</b> 265 POLINARI Anna - 273 TROIANI Virginia - 257 LUKUDO Raphaela Boaheng - 272 TREVISAN Giancarla Dimic	ITA	4	0.189	<b>3:29.93</b>
2	<b>SLOVENIA</b> 397 ZUPIN Agata - 396 SMONKAR Jerneja - 395 POGOREVC Maja - 393 HORVAT Anita	SLO	7	0.201	<b>3:31.51</b>
4	<b>TURKIYE</b> 435 AYAZ Sevvall - 440 EKATERINE Guliyev - 447 TOPTAS Tugba - 449 YILDIRIM Busra	TUR	5	0.485	<b>3:43.13</b>
5	<b>ALGERIA</b> 10 BENHADJA Loubna - 15 FERDI Douaa - 20 OUANIS Chaima - 12 BOULEHSA Meriem	ALG	3	0.422	<b>3:45.18</b>

### NOT RANKED

<b>MOROCCO</b> 327 LEHLALI Salma - 322 EL HACHIMI Sara - 330 RAZIKI Assia - 324 ENNADI Noura	MAR	6	<b>DQ</b> 17.3.1
---	-----	---	------------------

Details: Start time:20:05 Temperature:+24°C Humidity:80%

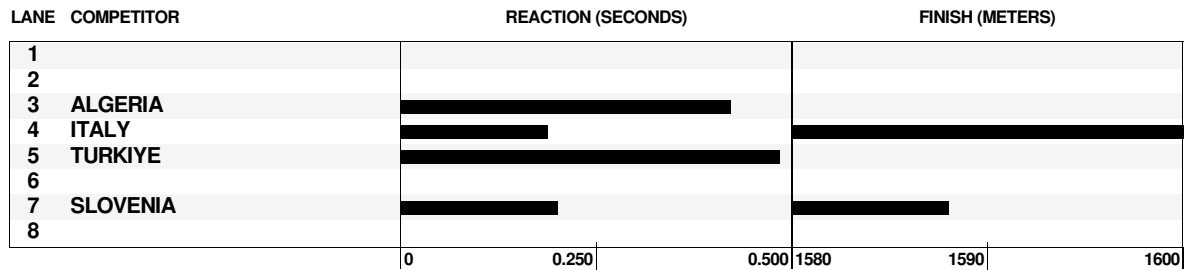

#### Legend

DNF = Did Not Finish	DNS = Did Not Start
DQ = Disqualified	Fn = False Start
R.T. = Reaction	

Oran 30 Juin - 3 Juillet

ATHW4X400M-----FNL-000100--\_73E 1.0 Data Processing and Timing by Microplus - www.microplustiming.com

1



ألعاب البحر الأبيض المتوسط  
MEDITERRANEAN GAMES  
JEUX MÉDITERRANÉENS  
du 25 juin au 06 juillet

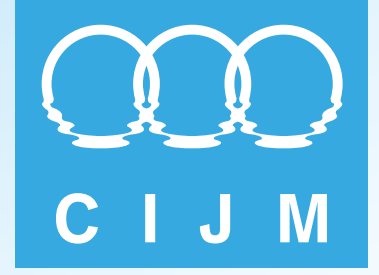

## Results Book



## Badminton



**TOSYALI  
ALGERIE**

Fer et Acier

سوناطراي



sonarach



microplus  
DATA PROCESSING & TIMING  
[www.microplustiming.com](http://www.microplustiming.com)



## Medallists by event

As of THU 30 JUN 2022 at 11:55

After 4 of 4 events

Event	Date	Medal	Name	CTRY Code
Women Single	THU 30 JUN 2022	GOLD	YIGIT Neslihan	TUR
		SILVER	CORRALES OCANA Beatriz	ESP
		BRONZE	BAYRAK Ozge	TUR
		BRONZE	HANY Doha	EGY
Men Single	THU 30 JUN 2022	GOLD	ABIAN VICEN Pablo	ESP
		SILVER	PENALVER PEREIRA Luis Enrique	ESP
		BRONZE	KRAPEZ Andraz	SLO
		BRONZE	LALE Emre	TUR
Women Double	MON 27 JUN 2022	GOLD	ERCETIN Benqisu INCI Nazlican	TUR
		SILVER	FINK Katharina HAMZA Yasmine	ITA
		BRONZE	CHRISTODOULOU Eleni KATTIRTZI RANJBAR Eva Nour	CYP
		BRONZE	LONCAR Sara SUDIMAC Marija	SRB
Men Double	MON 27 JUN 2022	GOLD	MAMMERI Koceila Julien MEDEL Youcef Sabri	ALG
		SILVER	ABIAN VICEN Pablo PENALVER PEREIRA Luis Enrique	ESP
		BRONZE	BAN Luka SPOLJAREC Filip	CRO
		BRONZE	CAPONIO Fabio TOTI Giovanni	ITA





## Medal Standings

As of THU 30 JUN 2022 at 11:54  
After 4 of 4 events

Rank	Country	Men				Women				Total				Rank by total
		G	S	B	Tot	G	S	B	Tot	G	S	B	Tot	
1	TUR - Turkiye			1	1	2		1	3	2		2	4	= 1
2	ESP - Spain	1	2		3		1		1	1	3		4	= 1
3	ALG - Algeria	1			1					1			1	= 4
4	ITA - Italy			1	1		1		1		1	1	2	3
5	CRO - Croatia			1	1							1	1	= 4
5	CYP - Cyprus							1	1			1	1	= 4
5	EGY - Egypt							1	1			1	1	= 4
5	SLO - Slovenia			1	1							1	1	= 4
5	SRB - Serbia							1	1			1	1	= 4
	<b>Total:</b>	<b>2</b>	<b>2</b>	<b>4</b>	<b>8</b>	<b>2</b>	<b>2</b>	<b>4</b>	<b>8</b>	<b>4</b>	<b>4</b>	<b>8</b>	<b>16</b>	

### LEGEND

= Equal sign indicates that two or more  
 Tot Total  
 B Bronze  
 G Gold  
 S Silver



## Entry List by Country

As of SAT 25 JUN 2022

Country	Gender	Name	Date of Birth	Event			
				S	D	S	D
ALG - Algeria	M	BELARBI Mohamed Abderrahime	8 AUG 1992	X			
	F	BOUKSANI Halla	30 JUL 2000			X	
	F	CHIBAH Yassmina	23 NOV 1999			X	
	M	HAMEK Adel	25 OCT 1992	X			
	M	MAMMERI Koceila Julien	23 FEB 1999		X		
	F	MAMMERI Tanina Violette	17 JUN 2003				X
	F	MAZRI Linda	21 DEC 2001				X
	M	MEDEL Youcef Sabri	5 JUL 1996		X		
CRO - Croatia	M	BAN Luka	24 JUN 2001	X	X		
	M	SPOLJAREC Filip	1 MAY 1994	X	X		
CYP - Cyprus	F	CHRISTODOULOU Eleni	31 MAR 1999			X	X
	M	HAILIS Christos	15 APR 2002	X	X		
	M	KATTIRTZI RANJBAR Aristotelis Aris	12 SEP 2003	X	X		
	F	KATTIRTZI RANJBAR Eva Nour	15 DEC 1920			X	X
EGY - Egypt	M	ELGAMAL Adham	4 FEB 1998	X	X		
	F	HANY Doha	10 SEP 1997			X	X
	M	SALAH Ahmed	30 SEP 1990	X	X		
	F	YOUSSR Nour	17 JUL 2003			X	X
ESP - Spain	M	ABIAN VICEN Pablo	12 JUN 1985	X	X		
	F	CORRALES OCANA Beatriz	3 DEC 1992			X	X
	M	PENALVER PEREIRA Luis Enrique	10 FEB 1996	X	X		
	F	SETIEN ERRO Ania	6 MAR 2003			X	X
FRA - France	F	CLOTEAUX-FOUCAULT Romane	25 JAN 2001			X	
	M	DESCHAMP Grégoire	1 APR 2003	X			
	M	VAN GYSEL Léo	10 FEB 2002	X			
GRE - Greece	F	LAMPRIANIDOU Theodora	14 FEB 2002			X	X
	M	MELIKIDIS Paschalis	30 OCT 1998	X	X		
	F	SOTIRIOU Grammatoula	18 APR 2002			X	X
	M	TSAMOUDIADIS Georgios Orfeas	9 FEB 2002	X	X		
ITA - Italy	M	CAPONIO Fabio	26 MAR 1999	X	X		
	F	FINK Katharina	14 NOV 2002			X	X
	F	HAMZA Yasmine	16 SEP 2003			X	X
	M	TOTI Giovanni	28 DEC 2000	X	X		
KOS - Kosovo	M	GLLAREVA Rinor	23 JUL 2002	X			
POR - Portugal	F	DA CUNHA GONCALVES Adriana Francisca	24 APR 1999			X	X
	M	MARREIROS GLÓRIA Diogo	19 APR 2002	X	X		
	M	RODRIGUES Gabriel Paolo Enzo	15 APR 2002	X	X		
	F	VERDASCA PINTO LEITE Mariana	3 JUL 1999			X	X
SLO - Slovenia	F	ARIH Nika	19 OCT 1998			X	X
	M	IVANIC Miha	22 MAY 1998	X	X		
	M	KRAPEZ Andraz	12 JAN 1997	X	X		
	F	POLANC Petra	17 AUG 2000			X	X



## Entry List by Country

As of SAT 25 JUN 2022

Country	Gender	Name	Date of Birth	Event			
				S	D	S	D
SRB - Serbia	F	LONCAR Saran	20 SEP 2003			X	X
	F	SUDIMAC Marija	27 MAR 2002			X	X
TUR - Turkey	F	BAYRAK Ozge	14 FEB 1992			X	
	F	ERCETIN Bengisu	6 MAR 2000				X
	F	INCI Nazlican	1 JAN 2001				X
	M	LALE Emre	13 OCT 1993	X			
	M	SARAC Nurullah	6 FEB 2003	X			
	F	YIGIT Neslihan	26 FEB 1994			X	

### LEGEND

D	Women's Double	D	Men's Double	F	Women	M	Men
S	Women's Single	S	Men's Single				



## Entry List by event

As of SAT 25 JUN 2022

CTRY	Name	World Ranking	Date of Birth
ALG - Algeria	BELARBI Mohamed Abderrahime		8 AUG 1992
	HAMEK Adel		25 OCT 1992
CRO - Croatia	BAN Luka		24 JUN 2001
	SPOLJAREC Filip		1 MAY 1994
CYP - Cyprus	HAILIS Christos		15 APR 2002
	KATTIRTZI RANJBAR Aristotelis Aris		12 SEP 2003
EGY - Egypt	ELGAMAL Adham		4 FEB 1998
	SALAH Ahmed		30 SEP 1990
ESP - Spain	ABIAN VICEN Pablo		12 JUN 1985
	PENALVER PEREIRA Luis Enrique		10 FEB 1996
FRA - France	DESCHAMP Grégoire		1 APR 2003
	VAN GYSEL Léo		10 FEB 2002
GRE - Greece	MELIKIDIS Paschalis		30 OCT 1998
	TSAMOUSIADIS Georgios Orfeas		9 FEB 2002
ITA - Italy	CAPONIO Fabio		26 MAR 1999
	TOTI Giovanni		28 DEC 2000
KOS - Kosovo	GLLAREVA Rinor		23 JUL 2002
POR - Portugal	MARREIROS GLÓRIA Diogo		19 APR 2002
	RODRIGUES Gabriel Paolo Enzo		15 APR 2002
SLO - Slovenia	IVANIC Miha		22 MAY 1998
	KRAPEZ Andraz		12 JAN 1997
TUR - Turkey	LALE Emre		13 OCT 1993
	SARAC Nurullah		6 FEB 2003



## Medallists

As of THU 30 JUN 2022 at 11:49

Medal	Name	CTRY
GOLD	ABIAN VICEN Pablo	ESP - Spain
SILVER	PENALVER PEREIRA Luis Enrique	ESP - Spain
BRONZE	KRAPEZ Andraz	SLO - Slovenia
BRONZE	LALE Emre	TUR - Turkiye



## Draw

As of THU 30 JUN 2022

2ndRound	NOC	Seed	3rdRound	Quarterfinals	Semifinals	Final															
ABIAN VICEN P.	ESP		ABIAN VICEN P.			<table border="1"> <thead> <tr> <th colspan="3">CLASSIFICATION</th> </tr> </thead> <tbody> <tr> <td>Gold</td> <td>ABIAN VICEN Pablo</td> <td>ESP</td> </tr> <tr> <td>Silver</td> <td>PENALVER PEREIRA Luis Enriq</td> <td>ESP</td> </tr> <tr> <td>Bronze</td> <td>KRAPEZ Andraz</td> <td>SLO</td> </tr> <tr> <td>Bronze</td> <td>LALE Emre</td> <td>TUR</td> </tr> </tbody> </table>	CLASSIFICATION			Gold	ABIAN VICEN Pablo	ESP	Silver	PENALVER PEREIRA Luis Enriq	ESP	Bronze	KRAPEZ Andraz	SLO	Bronze	LALE Emre	TUR
CLASSIFICATION																					
Gold	ABIAN VICEN Pablo	ESP																			
Silver	PENALVER PEREIRA Luis Enriq	ESP																			
Bronze	KRAPEZ Andraz	SLO																			
Bronze	LALE Emre	TUR																			
BYE																					
DESCHAMP G.	FRA		DESCHAMP G.	ABIAN VICEN P. 2-0 (21:16, 21:13)																	
BYE																					
MARREIROS D.	POR		MARREIROS D.		ABIAN VICEN P. 2-1 (13:21, 21:15, 21:10)																
BYE																					
MELIKIDIS P.	GRE		SALAH A. 2-0 (21:13, 21:17)	MARREIROS D. 2-0 (21:17, 21:19)																	
SALAH A.	EGY																				
LALE E.	TUR		LALE E.																		
BYE																					
HAMEK A.	ALG		HAMEK A.	LALE E. 2-0 (21:14, 21:13)																	
HAILIS C.	CYP																				
IVANIC M.	SLO		IVANIC M.		LALE E. 2-0 (21:13, 21:13)																
BYE																					
TOTI G.	ITA		TOTI G.																		
SPOLIAREC F.	CRO			TOTI G. 2-0 (22:20, 21:9)																	
CAPONIO F.	ITA		CAPONIO F.																		
KATTIRTZI A.	CYP			CAPONIO F. 2-0 (21:5, 21:12)																	
BYE																					
TSAMOUDIADIS G.	GRE		TSAMOUDIADIS G.																		
KRAPEZ A.	SLO		KRAPEZ A.		KRAPEZ A. 2-1 (27:25, 6:21, 21:17)																
VAN GYSEL L.	FRA			KRAPEZ A. 2-0 (21:14, 21:17)																	
BYE																					
ELGAMAL A.	EGY		ELGAMAL A.																		
GLLAREVA R.	KOS		BELARBI M. 2-0 (21:2, 21:1)																		
BELARBI M.	ALG			BAN L. 2-0 (21:14, 21:18)																	
BYE																					
BAN L.	CRO		BAN L.																		
SARAC N.	TUR		SARAC N.		PENALVER L. 2-0 (21:8, 21:16)																
RODRIGUES G.	POR			PENALVER L. 2-0 (21:18, 21:14)																	
BYE																					
PENALVER L.	ESP		PENALVER L.																		
						Gold Medal															
						ABIAN VICEN Pablo 2-0 (21:13, 22:20)															



THU 30 JUN 2022

## Match Results

Start Time 11:00 - End Time 12:48

**ABIAN VICEN Pablo**

**2 - 0**

**PENALVER PEREIRA Luis Enrique**

2-0 (21:13, 22:20)

Match No: S31

Court: : 1

### Game Summary

		Match	1st Game	2nd Game
<b>ABIAN VICEN Pablo</b>	<b>ESP</b>	<b>2</b>	21	22
<b>PENALVER PEREIRA Luis Enrique</b>	<b>ESP</b>	<b>0</b>	13	20
	Duration	<b>36min</b>	15min	21min
	Longest rally (seconds)	-	-	-
	Longest rally (strokes)	-	-	-
	Average rally (seconds)	-	-	-
	Average rally (strokes)	-	-	-
	Shuttles used	<b>19</b>	8	11

Umpires: BERTIN Veronique (FRA)

Service Judge: GULTEKIN Cengiz (TUR)

Player Statistics	ABIAN VICEN Pablo		PENALVER PEREIRA Luis Enrique	
	Game		Game	
	1	2	1	2
Total points played	34	42	34	42
Total points won	21	22	13	20
Most consecutive points won	4	5	3	5
Match points		2		-
Game points	1		-	
Points scored without serve	10	9	9	9
Points scored with serve	11	13	4	11
Biggest lead	8	3	1	4
Biggest comeback to win the game	1	4	-	-
Service faults	-	-	-	-
Penalties, Yellow/Red/Black Card(Score)	-	-	-	-
Successful / Unsuccessful challenges	0 / 0	0 / 0	0 / 0	0 / 0

1	<b>ABIAN VICEN Pablo</b>			1	2	3	4	5	6	7	8	9	10			11			12	13	14	15	16	17	18	19	20	21
	PENALVER PEREIRA Luis Enrique	1			2	3					4	5	6	7	8	9	10			11					12	13		
2	<b>ABIAN VICEN Pablo</b>				1	2	3				4	5		6	7	8	9	10	11	12	13				14	15	16	17
	PENALVER PEREIRA Luis Enrique	1	2	3			4	5	6	7		8	9				10			11	12	13	14	15	16			17
2	<b>ABIAN VICEN Pablo</b>	18	19			20	21	22																				
	PENALVER PEREIRA Luis Enrique			18	19	20																						

### LEGEND

D Women's Double      D Men's Double      R Red Card      S Women's Single  
S Men's Single      Y Yellow Card

**Note:** The "Greatest deficit overcome" only applies when the player ends up winning the game.



WED 29 JUN 2022

## Match Results

Start Time 17:00 - End Time 18:46

**ABIAN VICEN Pablo**

**2 - 0**

**LALE Emre**

2-0 (21:16, 21:18)

Match No: S29

Court: : 1

### Game Summary

		Match	1st Game	2nd Game
<b>ABIAN VICEN Pablo</b>	<b>ESP</b>	<b>2</b>	21	21
<b>LALE Emre</b>	<b>TUR</b>	<b>0</b>	16	18
Duration		<b>38min</b>	19min	19min
Longest rally (seconds)		-	-	-
Longest rally (strokes)		-	-	-
Average rally (seconds)		-	-	-
Average rally (strokes)		-	-	-
Shuttles used		<b>19</b>	11	8

Umpires: CABILES Anizette (ITA)

Service Judge: BERTIN Veronique (FRA)

Player Statistics	ABIAN VICEN Pablo		LALE Emre	
	Game		Game	
	1	2	1	2
Total points played	37	39	37	39
Total points won	21	21	16	18
Most consecutive points won	8	3	3	4
Match points		2		-
Game points	3		-	
Points scored without serve	11	12	10	12
Points scored with serve	10	9	6	6
Biggest lead	7	3	3	2
Biggest comeback to win the game	3	2	-	-
Service faults	-	-	-	-
Penalties, Yellow/Red/Black Card(Score)	-	-	-	-
Successful / Unsuccessful challenges	0 / 0	0 / 0	0 / 0	0 / 0

1	<b>ABIAN VICEN Pablo</b>	1	2	3		4	5		6	7	8	9	10	11	12	13	14	15	16	17	18	19	20	
	LALE Emre			1	2	3	4	5	6	7	8	9	10	11	12								13	14
1	<b>ABIAN VICEN Pablo</b>			21																				
	LALE Emre	15	16																					
2	<b>ABIAN VICEN Pablo</b>	1	2	3	4			5		6	7		8	9	10	11	12	13	14	15	16	17		
	LALE Emre			1		2	3	4	5	6	7		8	9	10	11	12		13		14	15	16	17
2	<b>ABIAN VICEN Pablo</b>	18	19	20	21																			
	LALE Emre				18																			

### LEGEND

D Women's Double      D Men's Double      R Red Card      S Women's Single  
S Men's Single      Y Yellow Card

**Note:** The "Greatest deficit overcome" only applies when the player ends up winning the game.





WED 29 JUN 2022

## Match Results

Start Time 17:40 - End Time 19:00

KRAPEZ Andraz

0 - 2

PENALVER PEREIRA Luis Enrique

0-2 (6:21, 18:21)

Match No: S30

Court: : 2

### Game Summary

		Match	1st Game	2nd Game
KRAPEZ Andraz	SLO	0	6	18
<b>PENALVER PEREIRA Luis Enrique</b>	<b>ESP</b>	<b>2</b>	21	21
Duration		<b>16min</b>	9min	7min
Longest rally (seconds)		-	-	-
Longest rally (strokes)		-	-	-
Average rally (seconds)		-	-	-
Average rally (strokes)		-	-	-
Shuttles used		<b>12</b>	4	8

Umpires: GULTEKIN Cengiz (TUR)

Service Judge: KHERRAZ Lamia (ALG)

Player Statistics	KRAPEZ Andraz		PENALVER PEREIRA Luis Enrique			
	Game		Game			
	1	2	1	2	3	4
Total points played	27	39	27	39		
Total points won	6	18	21	21		
Most consecutive points won	2	7	8	4		
Match points				4		
Game points			1			
Points scored without serve	5	9	5	9		
Points scored with serve	1	9	16	12		
Biggest lead	-	-	15	12		
Biggest comeback to win the game	-	-	-	-		
Service faults	-	-	-	-		
Penalties, Yellow/Red/Black Card(Score)	-	-	-	-		
Successful / Unsuccessful challenges	0 / 0	0 / 0	0 / 0	0 / 0		

1	KRAPEZ Andraz		1							2	3		4	5						6		
	PENALVER PEREIRA Luis Enrique	1	2	3	4	5	6	7	8	9	10	11	12	13	14	15	16	17	18	19	20	21

2	KRAPEZ Andraz				1				2				3			4			5	6	7	8	9	10	11	12	13	14	15
	PENALVER PEREIRA Luis Enrique	1	2	3	4	5	6	7	8	9	10	11	12	13	14	15	16	17	18	19									

2	KRAPEZ Andraz		16	17	18
	PENALVER PEREIRA Luis Enrique	20			21

### LEGEND

D Women's Double      D Men's Double      R Red Card      S Women's Single  
S Men's Single      Y Yellow Card

**Note:** The "Greatest deficit overcome" only applies when the player ends up winning the game.



## Entry List by event

As of SAT 25 JUN 2022

CTRY	Name	World Ranking	Date of Birth
ALG - Algeria	MAMMERI Koceila Julien		23 FEB 1999
	MEDEL Youcef Sabri		5 JUL 1996
CRO - Croatia	BAN Luka		24 JUN 2001
	SPOLJAREC Filip		1 MAY 1994
CYP - Cyprus	HAILIS Christos		15 APR 2002
	KATTIRTZI RANJBAR Aristotelis Aris		12 SEP 2003
EGY - Egypt	ELGAMAL Adham		4 FEB 1998
	SALAH Ahmed		30 SEP 1990
ESP - Spain	ABIAN VICEN Pablo		12 JUN 1985
	PENALVER PEREIRA Luis Enrique		10 FEB 1996
GRE - Greece	MELIKIDIS Paschalis		30 OCT 1998
	TSAMOUDIADIS Georgios Orfeas		9 FEB 2002
ITA - Italy	CAPONIO Fabio		26 MAR 1999
	TOTI Giovanni		28 DEC 2000
POR - Portugal	MARREIROS GLÓRIA Diogo		19 APR 2002
	RODRIGUES Gabriel Paolo Enzo		15 APR 2002
SLO - Slovenia	IVANIC Miha		22 MAY 1998
	KRAPEZ Andraz		12 JAN 1997



## Team Medallists

Medal	CTRY	Name
GOLD	ALG - Algeria	MAMMERI Koceila Julien MEDEL Youcef Sabri
SILVER	ESP - Spain	PENALVER PEREIRA Luis Enrique ABIAN VICEN Pablo
BRONZE	CRO - Croatia	BAN Luka SPOLJAREC Filip
BRONZE	ITA - Italy	CAPONIO Fabio TOTI Giovanni



## Draw

As of MON 27 JUN 2022



Gold Medal

Algeria

2-1 (14:21, 21:19, 21:16)



Salle Oued Tlelat  
Badminton  
Men's Double  
Gold-medal Match  
Match 15



MON 27 JUN 2022

Match Results

Start Time 18:00 - End Time 19:55

MAMMERI K.MEDEL Y.

2 - 1

PENALVER L.IABIAN VICEN P.

2-1 (14:21, 21:19, 21:16)

Match No: D15

Court: : 1

Game Summary

		Match	1st Game	2nd Game	3rd Game
MAMMERI K.MEDEL Y.	ALG	2	14	21	21
PENALVER L.IABIAN VICEN P.	ESP	1	21	19	16
Duration		48min	15min	17min	16min
Longest rally (seconds)		-	-	-	-
Longest rally (strokes)		-	-	-	-
Average rally (seconds)		-	-	-	-
Average rally (strokes)		-	-	-	-
Shuttles used		33	13	12	8

Umpires: GARDASEVIC Kristina (SRB)

Service Judge: BERTIN Veronique (FRA)

Player Statistics	MAMMERI K.MEDEL Y.			PENALVER L.IABIAN VICEN P.		
	Game			Game		
	1	2	3	1	2	3
Total points played	35	40	37	35	40	37
Total points won	14	21	21	21	19	16
Most consecutive points won	2	4	3	3	4	4
Match points			1			-
Game points	-	2		2	-	
Points scored without serve	13	12	9	13	11	9
Points scored with serve	1	9	12	8	8	7
Biggest lead	1	3	5	7	2	-
Biggest comeback to win the game	-	2	-	1	-	-
Service faults	-	-	-	-	-	-
Penalties, Yellow/Red/Black Card(Score)	-	-	-	-	-	-
Successful / Unsuccessful challenges	0 / 0	0 / 0	0 / 0	0 / 0	0 / 0	0 / 0

1	MAMMERI K.MEDEL Y.		1	2		3	4	5		6		7		8		9	10	11		12	13	14
	PENALVER L.IABIAN VICEN P.	1		2	3	4	5	6	7	8	9	10	11	12	13	14	15	16	17	18	19	20

1	MAMMERI K.MEDEL Y.																					
	PENALVER L.IABIAN VICEN P.	21																				

2	MAMMERI K.MEDEL Y.	1	2			3	4	5	6	7	8		9	10	11				12	13	14	15	16	17	18
	PENALVER L.IABIAN VICEN P.			1	2	3	4			5	6	7	8		9	10	11	12		13	14	15	16	17	18
2	MAMMERI K.MEDEL Y.		19	20	21																				
	PENALVER L.IABIAN VICEN P.	17	18	19																					

3	MAMMERI K.MEDEL Y.	1	2	3			4	5	6	7	8	9	10			11	12	13		14	15	16		17	18
	PENALVER L.IABIAN VICEN P.				1	2	3			4	5		6	7	8	9		10	11	12		13	14	15	16
3	MAMMERI K.MEDEL Y.	19	20	21																					
	PENALVER L.IABIAN VICEN P.																								

LEGEND

D Women's Double      D Men's Double      R Red Card      S Women's Single  
S Men's Single      Y Yellow Card

Note: The "Greatest deficit overcome" only applies when the player ends up winning the game.



MON 27 JUN 2022

## Match Results

Start Time 09:00 - End Time 10:51

MAMMERI K.MEDEL Y.

2 - 1

BAN L.SPOLJAREC F.

2-1 (18:21, 21:15, 21:14)

Match No: D13

Court: : 1

### Game Summary

		Match	1st Game	2nd Game	3rd Game
MAMMERI K.MEDEL Y.	ALG	2	18	21	21
BAN L.SPOLJAREC F.	CRO	1	21	15	14
Duration		39min	12min	12min	15min
Longest rally (seconds)		-	-	-	-
Longest rally (strokes)		-	-	-	-
Average rally (seconds)		-	-	-	-
Average rally (strokes)		-	-	-	-
Shuttles used		24	7	6	11

Umpires: CABILES Anizette (ITA)

Service Judge: JURES Dejan (SLO)

Player Statistics	MAMMERI K.MEDEL Y.			BAN L.SPOLJAREC F.		
	Game			Game		
	1	2	3	1	2	3
Total points played	39	36	35	39	36	35
Total points won	18	21	21	21	15	14
Most consecutive points won	6	10	4	4	4	3
Match points			2			-
Game points	-	2		1	-	
Points scored without serve	9	8	10	10	7	10
Points scored with serve	9	13	11	11	8	4
Biggest lead	1	6	7	5	4	1
Biggest comeback to win the game	-	4	1	1	-	-
Service faults	-	-	-	-	-	-
Penalties, Yellow/Red/Black Card(Score)	-	-	-	-	-	-
Successful / Unsuccessful challenges	0 / 0	0 / 0	0 / 0	0 / 0	0 / 0	0 / 0

1	MAMMERI K.MEDEL Y.	1	2	3	4	5	6	7	8	9	10	11	12	13	14	15	16	17	18
1	BAN L.SPOLJAREC F.	1	2	3	4	5	6	7	8	9	10	11	12	13	14	15	16	17	18
1	MAMMERI K.MEDEL Y.	17	18																
1	BAN L.SPOLJAREC F.	19	20	21															

2	MAMMERI K.MEDEL Y.	1	2	3	4	5	6	7	8	9	10	11	12	13	14	15	16	17	18	19	20
2	BAN L.SPOLJAREC F.	1	2	3	4	5	6	7	8	9	10	11	12	13	14	15	16	17	18	19	20
2	MAMMERI K.MEDEL Y.	21																			
2	BAN L.SPOLJAREC F.	15																			

3	MAMMERI K.MEDEL Y.	1	2	3	4	5	6	7	8	9	10	11	12	13	14	15	16	17	18	19	20
3	BAN L.SPOLJAREC F.	1	2	3	4	5	6	7	8	9	10	11	12	13	14	15	16	17	18	19	20
3	MAMMERI K.MEDEL Y.	21																			
3	BAN L.SPOLJAREC F.																				

### LEGEND

D Women's Double      D Men's Double      R Red Card      S Women's Single  
 S Men's Single      Y Yellow Card

**Note:** The "Greatest deficit overcome" only applies when the player ends up winning the game.



Salle Oued Tlelat

Badminton

Men's Double

Semi-finals

Match 14



MON 27 JUN 2022

## Match Results

Start Time 09:30 - End Time 11:35

CAPONIO F.\TOTI G.

1 - 2

PENALVER L.\ABIAN VICEN P.

1-2 (21:17, 15:21, 19:21)

Match No: D14

Court: : 2

## Game Summary

		Match	1st Game	2nd Game	3rd Game
CAPONIO F.\TOTI G.	ITA	1	21	15	19
PENALVER L.\ABIAN VICEN P.	ESP	2	17	21	21
Duration		49min	16min	15min	18min
Longest rally (seconds)		-	-	-	-
Longest rally (strokes)		-	-	-	-
Average rally (seconds)		-	-	-	-
Average rally (strokes)		-	-	-	-
Shuttles used		20	3	7	10

Umpires: AOUANOUC Anis (ALG)

Service Judge: KHERRAZ Lamia (ALG)

Player Statistics	CAPONIO F.\TOTI G.			PENALVER L.\ABIAN VICEN P.		
	Game			Game		
	1	2	3	1	2	3
Total points played	38	36	40	38	36	40
Total points won	21	15	19	17	21	21
Most consecutive points won	4	3	4	5	6	4
Match points			-			2
Game points	2	-		-	1	
Points scored without serve	10	10	12	9	11	12
Points scored with serve	11	5	7	8	10	9
Biggest lead	7	1	1	1	6	5
Biggest comeback to win the game	1	-	-	-	1	1
Service faults	-	-	-	-	-	-
Penalties, Yellow/Red/Black Card(Score)	-	-	-	-	-	-
Successful / Unsuccessful challenges	0 / 0	0 / 0	0 / 0	0 / 0	0 / 0	0 / 0

1	CAPONIO F.\TOTI G.		1	2	3	4	5	6	7	8				9	10	11	12	13	14		15	16	17	18	19					
	PENALVER L.\ABIAN VICEN P.	1	2			3			4	5	6	7	8	9	10				11			12		13	14	15				
1	CAPONIO F.\TOTI G.		20	21																										
	PENALVER L.\ABIAN VICEN P.	16	17																											
2	CAPONIO F.\TOTI G.	1		2		3		4		5		6		7	8	9	10	11	12		13	14					15			
	PENALVER L.\ABIAN VICEN P.		1	2	3	4	5	6	7	8	9	10	11				12	13			14	15	16	17	18	19				
2	CAPONIO F.\TOTI G.																													
	PENALVER L.\ABIAN VICEN P.		20	21																										
3	CAPONIO F.\TOTI G.		1		2	3		4		5		6		7	8	9	10				11	12	13	14		15		16	17	18
	PENALVER L.\ABIAN VICEN P.	1	2		3	4	5	6	7	8	9	10			11	12	13	14	15			16	17	18						
3	CAPONIO F.\TOTI G.		17	18	19																									
	PENALVER L.\ABIAN VICEN P.	19		20	21																									

## LEGEND

D Women's Double

D Men's Double

R Red Card

S Women's Single

S Men's Single

Y Yellow Card

Note: The "Greatest deficit overcome" only applies when the player ends up winning the game.

BDMMDOUBLES-----SFNL000200--\_73A.1.1

Report Created FRI 1 JUL 2022 16:16

Page 1 / 1

Data Processing and Timing by Microplus - www.microplustiming.com





## Entry List by event

As of SAT 25 JUN 2022

CTRY	Name	World Ranking	Date of Birth
ALG - Algeria	BOUKSANI Halla		30 JUL 2000
	CHIBAH Yassmina		23 NOV 1999
CYP - Cyprus	CHRISTODOULOU Eleni		31 MAR 1999
	KATTIRTZI RANJBAR Eva Nour		15 DEC 1920
EGY - Egypt	HANY Doha		10 SEP 1997
	YOUSSR Nour		17 JUL 2003
ESP - Spain	CORRALES OCANA Beatriz		3 DEC 1992
	SETIEN ERRO Ania		6 MAR 2003
FRA - France	CLOTEAUX-FOUCAULT Romane		25 JAN 2001
GRE - Greece	LAMPRIANIDOU Theodora		14 FEB 2002
	SOTIRIOU Grammatoula		18 APR 2002
ITA - Italy	FINK Katharina		14 NOV 2002
	HAMZA Yasmine		16 SEP 2003
POR - Portugal	DA CUNHA GONCALVES Adriana Francisca		24 APR 1999
	VERDASCA PINTO LEITE Mariana		3 JUL 1999
SLO - Slovenia	ARIH Nika		19 OCT 1998
	POLANC Petra		17 AUG 2000
SRB - Serbia	LONCAR Saran		20 SEP 2003
	SUDIMAC Marija		27 MAR 2002
TUR - Turkey	BAYRAK Ozge		14 FEB 1992
	YIGIT Neslihan		26 FEB 1994





## Medallists

As of THU 30 JUN 2022 at 11:19

Medal	Name	CTRY
GOLD	YIGIT Neslihan	TUR - Turkiye
SILVER	CORRALES OCANA Beatriz	ESP - Spain
BRONZE	BAYRAK Ozge	TUR - Turkiye
BRONZE	HANY Doha	EGY - Egypt



Draw

As of THU 30 JUN 2022

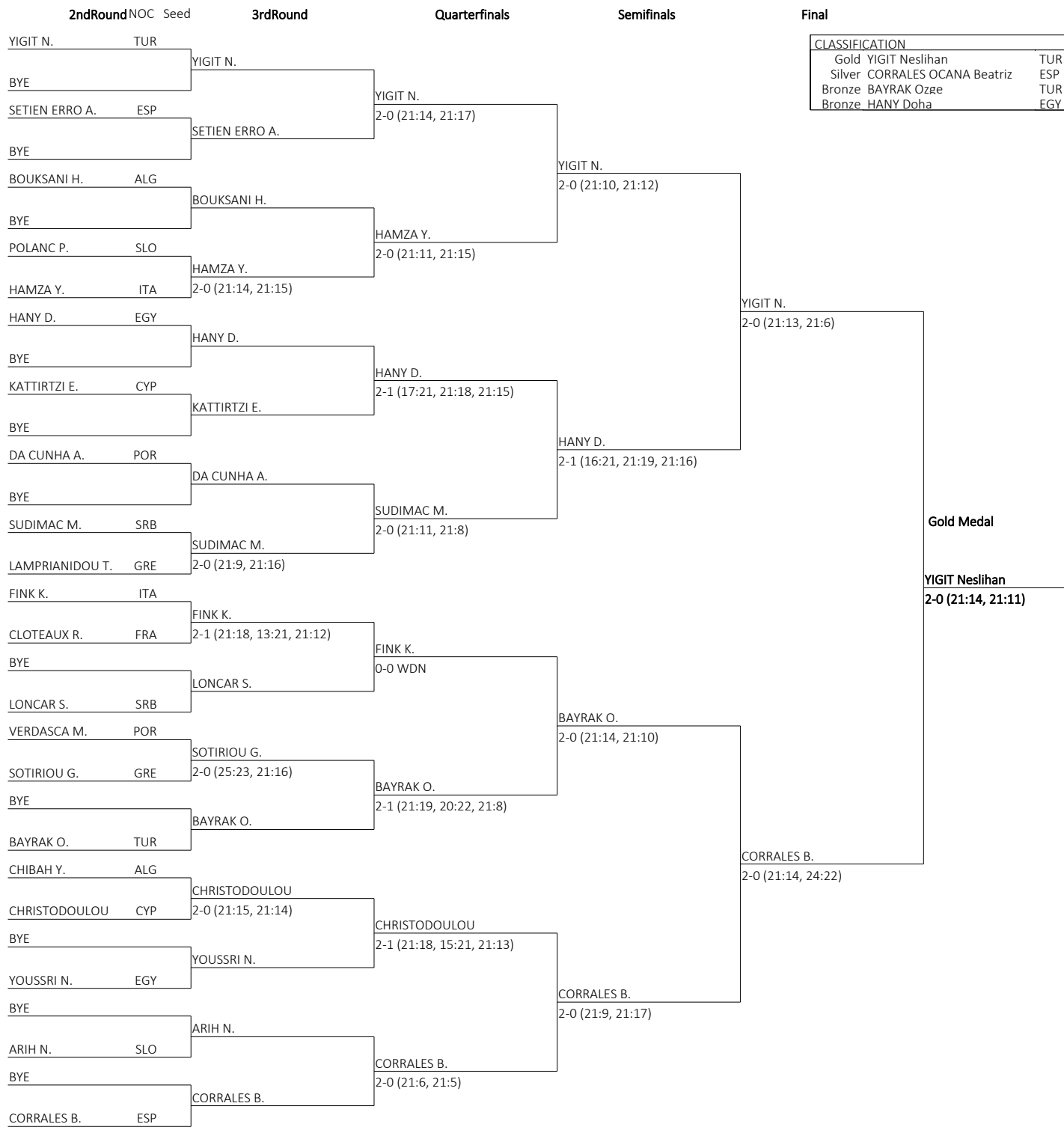

CLASSIFICATION		
Gold	YIGIT Neslihan	TUR
Silver	CORRALES OCANA Beatriz	ESP
Bronze	BAYRAK Ozge	TUR
Bronze	HANY Doha	EGY

Gold Medal

YIGIT Neslihan  
2-0 (21:14, 21:11)





THU 30 JUN 2022

## Match Results

Start Time 10:20 - End Time 12:02

**YIGIT Neslihan**

**2 - 0**

**CORRALES OCANA Beatriz**

2-0 (21:14, 21:11)

Match No: S31

Court: : 1

### Game Summary

		Match	1st Game	2nd Game
<b>YIGIT Neslihan</b>	<b>TUR</b>	<b>2</b>	21	21
<b>CORRALES OCANA Beatriz</b>	<b>ESP</b>	<b>0</b>	14	11
Duration		<b>36min</b>	19min	17min
Longest rally (seconds)		-	-	-
Longest rally (strokes)		-	-	-
Average rally (seconds)		-	-	-
Average rally (strokes)		-	-	-
Shuttles used		<b>6</b>	3	3

Umpires: BOUCHEFA Djamel (ALG)

Service Judge: CABILES Anizette (ITA)

Player Statistics	YIGIT Neslihan		CORRALES OCANA Beatriz	
	Game		Game	
	1	2	1	2
Total points played	35	32	35	32
Total points won	21	21	14	11
Most consecutive points won	4	5	3	4
Match points		1		-
Game points	1		-	
Points scored without serve	9	6	9	6
Points scored with serve	12	15	5	5
Biggest lead	7	10	-	1
Biggest comeback to win the game	-	1	-	-
Service faults	-	-	-	-
Penalties, Yellow/Red/Black Card(Score)	-	-	-	-
Successful / Unsuccessful challenges	0 / 0	0 / 0	0 / 0	0 / 0

1	<b>YIGIT Neslihan</b>	1	2		3	4	5	6	7	8	9	10	11	12	13	14	15	16	17	18	19	20	
	CORRALES OCANA Beatriz			1	2		3	4				5	6	7	8		9		10	11	12	13	14
1	<b>YIGIT Neslihan</b>	21																					
	CORRALES OCANA Beatriz																						

2	<b>YIGIT Neslihan</b>	1	2	3	4	5	6				7	8	9	10	11	12	13	14	15	16	17	18	19	20	21
	CORRALES OCANA Beatriz			1	2	3			4	5	6	7				8				9	10	11			

### LEGEND

D Women's Double      D Men's Double      R Red Card      S Women's Single  
S Men's Single      Y Yellow Card

**Note:** The "Greatest deficit overcome" only applies when the player ends up winning the game.



Salle Oued Tlelat  
Badminton  
Women's Single  
Semi-finals  
Match 29



WED 29 JUN 2022

Match Results

Start Time 17:00 - End Time 18:28

YIGIT Neslihan

2 - 0  
2-0 (21:13, 21:6)

HANY Doha

Match No: S29

Court: : 2

Game Summary

		Match	1st Game	2nd Game
YIGIT Neslihan	TUR	2	21	21
HANY Doha	EGY	0	13	6
Duration		23min	13min	10min
Longest rally (seconds)		-	-	-
Longest rally (strokes)		-	-	-
Average rally (seconds)		-	-	-
Average rally (strokes)		-	-	-
Shuttles used		5	2	3

Umpires: JURES Dejan (SLO)

Service Judge: AOUANOUK Anis (ALG)

Player Statistics	YIGIT Neslihan		HANY Doha	
	Game		Game	
	1	2	1	2
Total points played	34	27	34	27
Total points won	21	21	13	6
Most consecutive points won	6	7	3	4
Match points		1		-
Game points	1		-	
Points scored without serve	8	3	8	3
Points scored with serve	13	18	5	3
Biggest lead	8	15	-	-
Biggest comeback to win the game	-	-	-	-
Service faults	-	-	-	-
Penalties, Yellow/Red/Black Card(Score)	-	-	-	-
Successful / Unsuccessful challenges	0 / 0	0 / 0	0 / 0	0 / 0

1	YIGIT Neslihan	1	2	3	4	5	6		7	8	9		10	11		12	13	14	15	16	17	18	19		20	21	
	HANY Doha						1	2				3	4	5	6	7	8	9	10	11				12	13		

2	YIGIT Neslihan	1	2	3	4	5	6	7	8	9				10	11	12	13	14	15	16	17	18	19	20	21		
	HANY Doha							1			2	3	4	5						6							

LEGEND

D Women's Double      D Men's Double      R Red Card      S Women's Single  
S Men's Single      Y Yellow Card

Note: The "Greatest deficit overcome" only applies when the player ends up winning the game.



WED 29 JUN 2022

### Match Results

Start Time 17:40 - End Time 19:29

BAYRAK Ozge

0 - 2

CORRALES OCANA Beatriz

0-2 (14:21, 22:24)

Match No: S30

Court: : 1

#### Game Summary

		Match	1st Game	2nd Game
BAYRAK Ozge	TUR	0	14	22
<b>CORRALES OCANA Beatriz</b>	<b>ESP</b>	<b>2</b>	21	24
Duration		<b>34min</b>	13min	21min
Longest rally (seconds)		-	-	-
Longest rally (strokes)		-	-	-
Average rally (seconds)		-	-	-
Average rally (strokes)		-	-	-
Shuttles used		<b>4</b>	2	2

Umpires: GARDASEVIC Kristina (SRB)

Service Judge: DOS SANTOS QUELUZ Maria Margarida (POR)

Player Statistics	BAYRAK Ozge		CORRALES OCANA Beatriz	
	Game		Game	
	1	2	1	2
Total points played	35	46	35	46
Total points won	14	22	21	24
Most consecutive points won	3	4	6	4
Match points		-		5
Game points	-		1	
Points scored without serve	10	12	10	12
Points scored with serve	4	10	11	12
Biggest lead	1	3	7	4
Biggest comeback to win the game	-	-	1	3
Service faults	-	-	-	-
Penalties, Yellow/Red/Black Card(Score)	-	-	-	-
Successful / Unsuccessful challenges	0 / 0	0 / 0	0 / 0	0 / 0

1	BAYRAK Ozge			1	2	3				4	5	6			7	8	9	10	11	12	13							14				
	<b>CORRALES OCANA Beatriz</b>	1		2	3	4	5	6	7	8	9	10	11			12	13			14	15	16	17	18	19			20				
1	BAYRAK Ozge																															
	<b>CORRALES OCANA Beatriz</b>	21																														
2	BAYRAK Ozge			1				2	3	4	5	6			7	8	9	10			11	12			13		14		15			
	<b>CORRALES OCANA Beatriz</b>	1		2	3	4	5				6	7	8				9			10	11	12			13	14		15	16	17	18	19
2	BAYRAK Ozge	16	17	18		19	20			21	22																					
	<b>CORRALES OCANA Beatriz</b>			20			21			22																						

#### LEGEND

D Women's Double      D Men's Double      R Red Card      S Women's Single  
 S Men's Single      Y Yellow Card

**Note:** The "Greatest deficit overcome" only applies when the player ends up winning the game.



## Entry List by event

As of SAT 25 JUN 2022

CTRY	Name	World Ranking	Date of Birth
ALG - Algeria	MAMMERI Tanina Violette		17 JUN 2003
	MAZRI Linda		21 DEC 2001
CYP - Cyprus	CHRISTODOULOU Eleni		31 MAR 1999
	KATTIRTZI RANJBAR Eva Nour		15 DEC 1920
EGY - Egypt	HANY Doha		10 SEP 1997
	YOUSSR Nour		17 JUL 2003
ESP - Spain	CORRALES OCANA Beatriz		3 DEC 1992
	SETIEN ERRO Ania		6 MAR 2003
GRE - Greece	LAMPRIANIDOU Theodora		14 FEB 2002
	SOTIRIOU Grammatoula		18 APR 2002
ITA - Italy	FINK Katharina		14 NOV 2002
	HAMZA Yasmine		16 SEP 2003
POR - Portugal	DA CUNHA GONCALVES Adriana Francisca		24 APR 1999
	VERDASCA PINTO LEITE Mariana		3 JUL 1999
SLO - Slovenia	ARIH Nika		19 OCT 1998
	POLANC Petra		17 AUG 2000
SRB - Serbia	LONCAR Saran		20 SEP 2003
	SUDIMAC Marija		27 MAR 2002
TUR - Turkey	ERCETIN Bengisu		6 MAR 2000
	INCI Nazlican		1 JAN 2001



## Team Medallists

Medal	CTRY	Name
GOLD	TUR - Turkey	INCI Nazlican ERCETIN Bengisu
SILVER	ITA - Italy	FINK Katharina HAMZA Yasmine
BRONZE	CYP - Cyprus	KATTIRTZI RANJBAR Eva Nour CHRISTODOULOU Eleni
BRONZE	SRB - Serbia	SUDIMAC Marija LONCAR Sara



## Draw

As of FRI 1 JUL 2022

3rdRound	NOC	Seed	Quarterfinals	Semifinals	Final
ERCETIN B./INCI N.	TUR		ERCETIN B./INCI N.		
BYE				ERCETIN B./INCI N.	
SETIEN ERRO A./CORRAL	ESP		SETIEN ERRO A./CORRAL	ERCETIN B./INCI N. 2-0 (21:8, 21:15)	
BYE					
HANY D./YOUSSEFI N.	EGY		HANY D./YOUSSEFI N.		ERCETIN B./INCI N. 2-0 (21:10, 21:11)
BYE					
SUDIMAC M./LONCAR S.	SRB		SUDIMAC M./LONCAR S. 2-0 (21:10, 21:14)	SUDIMAC M./LONCAR S. 2-0 (21:15, 21:12)	
SOTIRIOU G./LAMPRIANI	GRE				
KATTIRTZI E./CHRISTOD	CYP		KATTIRTZI E./CHRISTOD 2-0 (21:15, 21:19)		
VERDASCA M./DA CUNHA	POR			KATTIRTZI E./CHRISTOD 2-0 (21:9, 21:9)	
BYE					
MAMMERI T.V./MAZRI L.	ALG		MAMMERI T.V./MAZRI L.		
BYE					
ARIH N./POLANC P.	SLO		ARIH N./POLANC P.		FINK K./HAMZA Y. 2-0 (21:16, 21:17)
BYE					
FINK K./HAMZA Y.	ITA		FINK K./HAMZA Y.	FINK K./HAMZA Y. 2-0 (21:18, 21:13)	

CLASSIFICATION	
Gold	Turkiye TUR
Silver	Italy ITA
Bronze	Cyprus CYP
	Serbia SRB

Gold Medal

Turkiye

2-0 (21:15, 21:18)





MON 27 JUN 2022

## Match Results

Start Time 17:00 - End Time 18:44

ERCETIN B.\INCI N.

2 - 0

FINK K.\HAMZA Y.

2-0 (21:15, 21:18)

Match No: D15

Court: : 1

### Game Summary

		Match	1st Game	2nd Game
ERCETIN B.\INCI N.	TUR	2	21	21
FINK K.\HAMZA Y.	ITA	0	15	18
Duration		34min	16min	18min
Longest rally (seconds)		-	-	-
Longest rally (strokes)		-	-	-
Average rally (seconds)		-	-	-
Average rally (strokes)		-	-	-
Shuttles used		17	10	7

Umpires: CARDENAS BLANCO Antonio (ESP)

Service Judge: BOUCHEFA Djamel (ALG)

Player Statistics	ERCETIN B.\INCI N.		FINK K.\HAMZA Y.	
	Game		Game	
	1	2	1	2
Total points played	36	39	36	39
Total points won	21	21	15	18
Most consecutive points won	6	3	4	3
Match points		2		-
Game points	1		-	
Points scored without serve	9	14	9	14
Points scored with serve	12	7	6	4
Biggest lead	6	3	2	1
Biggest comeback to win the game	2	1	-	-
Service faults	-	-	-	-
Penalties, Yellow/Red/Black Card(Score)	-	-	-	-
Successful / Unsuccessful challenges	0 / 0	0 / 0	0 / 0	0 / 0

1	ERCETIN B.\INCI N.	1	2					3	4	5	6	7	8	9	10	11			12	13			14	15	16	17	18	19
	FINK K.\HAMZA Y.			1	2	3	4							5		6	7	8	9	10	11	12		13	14		15	
1	ERCETIN B.\INCI N.	20	21																									
	FINK K.\HAMZA Y.																											
2	ERCETIN B.\INCI N.	1	2	3	4	5	6	7	8	9	10	11	12			13	14	15	16	17	18							
	FINK K.\HAMZA Y.		1	2		3		4	5	6	7	8	9	10		11	12	13	14	15	16							
2	ERCETIN B.\INCI N.		19	20	21																							
	FINK K.\HAMZA Y.	17		18																								

### LEGEND

D Women's Double      D Men's Double      R Red Card      S Women's Single  
S Men's Single      Y Yellow Card

**Note:** The "Greatest deficit overcome" only applies when the player ends up winning the game.



Salle Oued Tlelat  
Badminton  
Women's Double  
Semi-finals  
Match 13



MON 27 JUN 2022

Match Results

Start Time 09:00 - End Time 10:32

ERCETIN B.\INCI N.

2 - 0

SUDIMAC M.\LONCAR S.

2-0 (21:10, 21:11)

Match No: D13

Court: : 2

Game Summary

		Match	1st Game	2nd Game
ERCETIN B.\INCI N.	TUR	2	21	21
SUDIMAC M.\LONCAR S.	SRB	0	10	11
Duration		24min	12min	12min
Longest rally (seconds)		-	-	-
Longest rally (strokes)		-	-	-
Average rally (seconds)		-	-	-
Average rally (strokes)		-	-	-
Shuttles used		10	4	6

Umpires: AMARNI Chawki (ALG)

Service Judge: DOS SANTOS QUELUZ Maria Margarida (POR)

Player Statistics	ERCETIN B.\INCI N.		SUDIMAC M.\LONCAR S.	
	Game		Game	
	1	2	1	2
Total points played	31	32	31	32
Total points won	21	21	10	11
Most consecutive points won	5	4	2	2
Match points		1		-
Game points	1		-	
Points scored without serve	7	10	6	10
Points scored with serve	14	11	4	1
Biggest lead	11	10	2	1
Biggest comeback to win the game	2	1	-	-
Service faults	-	-	-	-
Penalties, Yellow/Red/Black Card(Score)	-	-	-	-
Successful / Unsuccessful challenges	0 / 0	0 / 0	0 / 0	0 / 0

1	ERCETIN B.\INCI N.			1	2	3	4	5	6		7	8	9	10	11	12		13	14	15	16	17	18	19	20	21
	SUDIMAC M.\LONCAR S.	1	2				3	4	5	6		7				8	9						10			

2	ERCETIN B.\INCI N.		1	2	3	4	5	6	7	8	9	10	11	12	13	14		15	16	17	18	19	20	21
	SUDIMAC M.\LONCAR S.	1		2		3		4		5		6	7		8	9	10						11	

LEGEND

D Women's Double      D Men's Double      R Red Card      S Women's Single  
S Men's Single      Y Yellow Card

Note: The "Greatest deficit overcome" only applies when the player ends up winning the game.



MON 27 JUN 2022

## Match Results

Start Time 09:30 - End Time 11:32

KATTIRTZI E.\CHRISTODOULOU

0 - 2

FINK K.\HAMZA Y.

0-2 (16:21, 17:21)

Match No: D14

Court: : 1

### Game Summary

		Match	1st Game	2nd Game
KATTIRTZI E.\CHRISTODOULOU	CYP	0	16	17
FINK K.\HAMZA Y.	ITA	2	21	21
Duration		30min	16min	14min
Longest rally (seconds)		-	-	-
Longest rally (strokes)		-	-	-
Average rally (seconds)		-	-	-
Average rally (strokes)		-	-	-
Shuttles used		15	11	4

Umpires: BERTIN Veronique (FRA)

Service Judge: GULTEKIN Cengiz (TUR)

Player Statistics	KATTIRTZI E.\CHRISTODOULOU		FINK K.\HAMZA Y.	
	Game		Game	
	1	2	1	2
Total points played	37	38	37	38
Total points won	16	17	21	21
Most consecutive points won	4	4	4	5
Match points		-		5
Game points	-		1	
Points scored without serve	11	11	12	11
Points scored with serve	5	6	9	10
Biggest lead	3	2	5	7
Biggest comeback to win the game	-	-	3	2
Service faults	-	-	-	-
Penalties, Yellow/Red/Black Card(Score)	-	-	-	-
Successful / Unsuccessful challenges	0 / 0	0 / 0	0 / 0	0 / 0

1	KATTIRTZI E.\CHRISTODOULOU	1	2	3	4	5	6	7	8	9	10	11	12	13	14	15	16					
	FINK K.\HAMZA Y.	1	2	3	4	5	6	7	8	9	10	11	12	13	14	15	16	17	18			
1	KATTIRTZI E.\CHRISTODOULOU																					
	FINK K.\HAMZA Y.	19	20	21																		
2	KATTIRTZI E.\CHRISTODOULOU	1	2	3	4	5	6	7	8	9	10	11	12	13	14	15	16	17	18	19	20	21
	FINK K.\HAMZA Y.	1	2	3	4	5	6	7	8	9	10	11	12	13	14	15	16	17	18	19	20	21
2	KATTIRTZI E.\CHRISTODOULOU	15	16	17																		
	FINK K.\HAMZA Y.				21																	

### LEGEND

D Women's Double      D Men's Double      R Red Card      S Women's Single  
S Men's Single      Y Yellow Card

**Note:** The "Greatest deficit overcome" only applies when the player ends up winning the game.



## Number of Entries by Country

As of SUN 26 JUN 2022

Code	Country	Entries by Event				Number of Athletes		
		S	D	S	D	Men	Women	Total
ALG	Algeria	2	1	2	1	4	4	8
CRO	Croatia	2	1			2	0	2
CYP	Cyprus	2	1	2	1	2	2	4
EGY	Egypt	2	1	2	1	2	2	4
ESP	Spain	2	1	2	1	2	2	4
FRA	France	2		1		2	1	3
GRE	Greece	2	1	2	1	2	2	4
ITA	Italy	2	1	2	1	2	2	4
KOS	Kosovo	1				1	0	1
POR	Portugal	2	1	2	1	2	2	4
SLO	Slovenia	2	1	2	1	2	2	4
SRB	Serbia			2	1	0	2	2
TUR	Turkey	2		2	1	2	4	6
	Total: 13	23	9	21	10	25	25	50

### LEGEND

-  
-



ألعاب البحر الأبيض المتوسط  
MEDITERRANEAN GAMES  
JEUX MÉDITERRANÉENS  
du 25 juin au 06 juillet

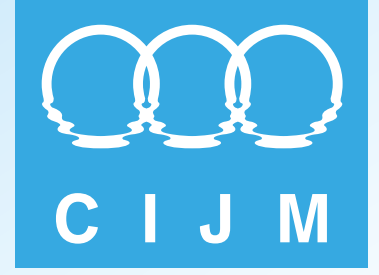

## Results Book



# Basketball



**TOSYALI  
ALGERIE**

Fer et Acier

سوناطراي



sonarach



microplus  
DATA PROCESSING & TIMING  
[www.microplustiming.com](http://www.microplustiming.com)



## Medallists by event

As of MON 4 JUL 2022 at 00:13

Event	Date	Medal	Name	Country Code
Women	SUN 3 JUL 2022	Gold	<b>SPAIN</b> RODRIGUEZ DOMINGUEZ Natalia AYUSO BAGUR Aina GUERRERO ALCANTARA Carolina PUEYO MELCHOR Helena	ESP
		Silver	<b>FRANCE</b> NGO NDJOCK Anna Sara PARDON Marie Helene PEYTOUR-RAISON Emma DROGUET Camille Marie	FRA
		Bronze	<b>ITALY</b> DEL PERO Beatrice MADERA Sara BONGIORNO Giulia SMORTO Giovanna Elena	ITA



## Medallists by event

As of MON 4 JUL 2022 at 00:13

Event	Date	Medal	Name	Country Code
Men	SUN 3 JUL 2022	Gold	<b>FRANCE</b> GOMIS Marcus Theotim DELAUNAY Leopold Olivier BRUYAS Arthur THIROUARD SAMSON Lorenzo Valentin	FRA
		Silver	<b>SERBIA</b> ANTIC Milos MOMIROV Stefan STANKOVIC Nemanja KOVACEVIC Nikola	SRB
		Bronze	<b>SPAIN</b> MENDICOTE RUBIO Unai ARCOS GONZALEZ Guillem MAYO SCHWANDT Isaac GONZALEZ LONGARELA Pablo	ESP



## Medallists

As of MON 4 JUL 2022 at 00:13

Gold	Silver	Bronze
<b>FRA - France</b>	<b>SRB - Serbia</b>	<b>ESP - Spain</b>
4 GOMIS Marcus Theotim	8 ANTIC Milos	3 MENDICOTE RUBIO Unai
6 DELAUNAY Leopold Olivier	9 MOMIROV Stefan	7 ARCOS GONZALEZ Guillem
10 BRUYAS Arthur	10 STANKOVIC Nemanja	9 MAYO SCHWANDT Isaac
17 THIROUARD SAMSON Lorenzo Valentin	13 KOVACEVIC Nikola	44 GONZALEZ LONGARELA Pablo





## Pool standings

As of SAT 2 JUL 2022 at 00:59

Group A					Games				Points				
Rank		TUR	ALG	ITA	Played	Won	Lost	%Won	For	Against	Diff.	Class.	Avg. P.
1	TUR	---	18 - 19	21 - 10	2	1	1	50	39	29	10	2	19.5
2	ALG	19 - 18	---	16 - 21	2	1	1	50	35	39	-4	2	17.5
3	ITA	10 - 21	21 - 16	---	2	1	1	50	31	37	-6	2	15.5

Group B					Games				Points				
Rank		ESP	POR	SLO	Played	Won	Lost	%Won	For	Against	Diff.	Class.	Avg. P.
1	ESP	---	14 - 12	21 - 5	2	2	0	100	35	17	18	4	17.5
2	POR	12 - 14	---	12 - 8	2	1	1	50	24	22	2	2	12.0
3	SLO	5 - 21	8 - 12	---	2	0	2	0	13	33	-20	0	6.5

Group C					Games				Points				
Rank		SRB	FRA	CYP	Played	Won	Lost	%Won	For	Against	Diff.	Class.	Avg. P.
1	SRB	---	21 - 19	19 - 16	2	2	0	100	40	35	5	4	20.0
2	FRA	19 - 21	---	20 - 3	2	1	1	50	39	24	15	2	19.5
3	CYP	16 - 19	3 - 20	---	2	0	2	0	19	39	-20	0	9.5

Group D						Games				Points				
Rank		GRE	CRO	EGY	TUN	Played	Won	Lost	%Won	For	Against	Diff.	Class.	Avg. P.
1	GRE	---	17 - 16	18 - 15	17 - 13	3	3	0	100	52	44	8	6	17.3
2	CRO	16 - 17	---	17 - 12	14 - 15	3	1	2	33	47	44	3	2	15.7
3	EGY	15 - 18	12 - 17	---	10 - 8	3	1	2	33	37	43	-6	2	12.3
4	TUN	13 - 17	15 - 14	8 - 10	---	3	1	2	33	36	41	-5	2	12.0

## Games Schedule

Date	Start time	Phase	Game	Teams	Result
THU 30 JUN	18:40	Preliminary Group D	3	GRE - CRO	17 - 16
THU 30 JUN	19:00	Preliminary Group D	4	EGY - TUN	10 - 8
THU 30 JUN	20:00	Preliminary Group A	7	TUR - ALG	18 - 19
THU 30 JUN	20:20	Preliminary Group B	8	ESP - POR	14 - 12
THU 30 JUN	21:00	Preliminary Group C	10	SRB - CYP	19 - 16
THU 30 JUN	22:00	Preliminary Group D	13	CRO - TUN	14 - 15
THU 30 JUN	22:20	Preliminary Group D	14	GRE - EGY	18 - 15
FRI 1 JUL	19:00	Preliminary Group A	17	ITA - TUR	10 - 21
FRI 1 JUL	19:20	Preliminary Group B	18	SLO - ESP	5 - 21
FRI 1 JUL	20:40	Preliminary Group C	22	FRA - SRB	19 - 21
FRI 1 JUL	21:00	Preliminary Group D	23	CRO - EGY	17 - 12
FRI 1 JUL	21:20	Preliminary Group D	24	TUN - GRE	13 - 17
FRI 1 JUL	22:20	Preliminary Group A	27	ALG - ITA	16 - 21
FRI 1 JUL	22:40	Preliminary Group B	28	POR - SLO	12 - 8



## Pool standings

As of SAT 2 JUL 2022 at 00:59

### Games Schedule

Date	Start time	Phase	Game	Teams	Result
FRI 1 JUL	23:20	Preliminary Group C	30	CYP - FRA	3 - 20



## Brackets

As of MON 4 JUL 2022 at 00:19

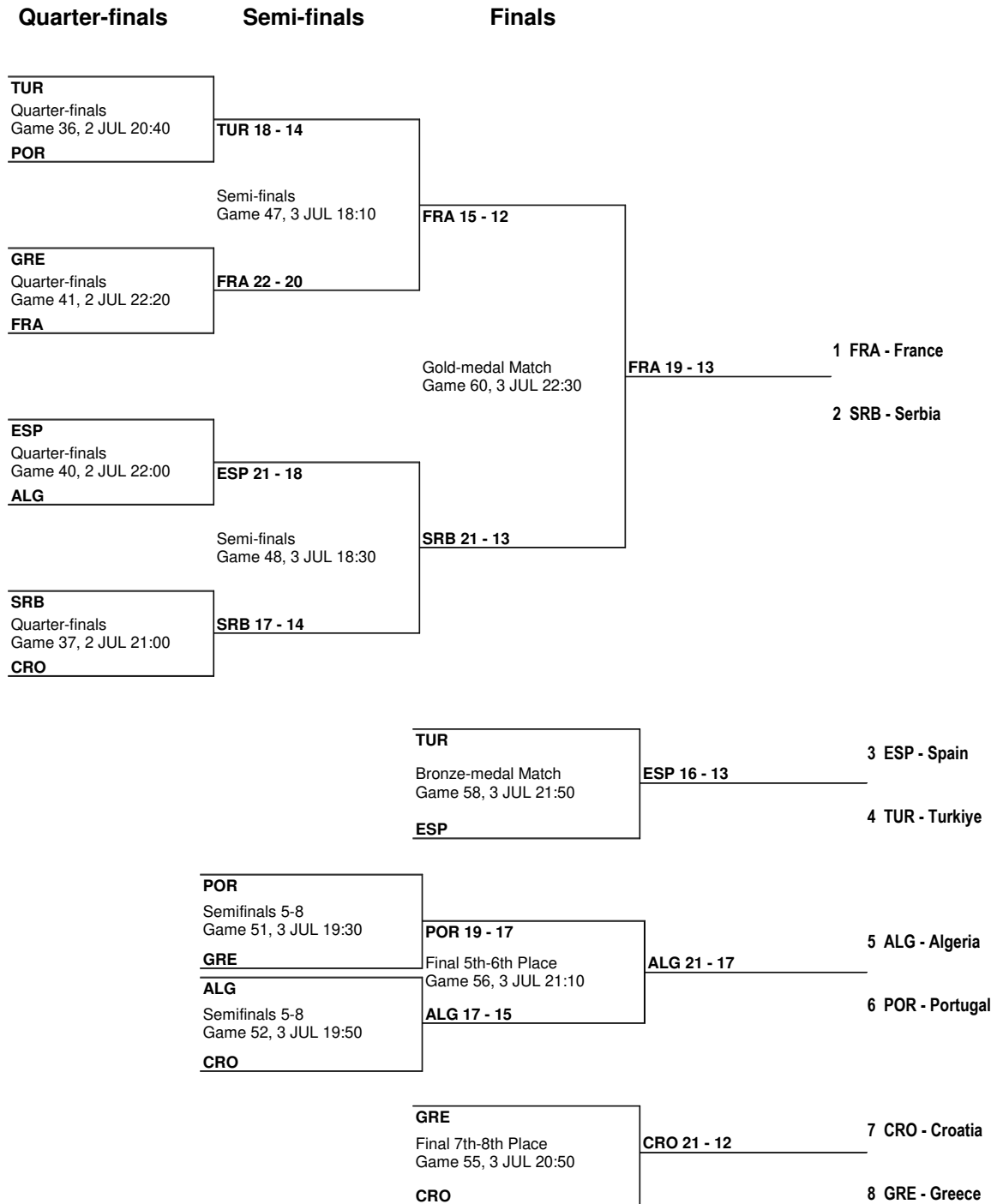



## Brackets

As of MON 4 JUL 2022 at 00:19





## Team Roster

REVISED  
FRI 1 JUL 00:23

As of FRI 1 JUL 2022 at 00:23

### ALG - Algeria

No.	Name	Pos	Height	Date of Birth	Age	Club	Int. Matches
5	HIFI Nadir		1.88 / 6 ' 2 "	16 JUL 2002	20		
6	MEDJOUBI Bacim		1.94 / 6 ' 4 "	20 OCT 2001	21		
7	TALEB Islam-Nizar		2.03 / 6 ' 8 "	4 MAR 1999	23		
8	BELLIL Mehdi		1.93 / 6 ' 4 "	30 MAR 2001	21		
Team averages			1.94 / 6 ' 4 "		21.3		

#### Team Uniform Color

Light White

Dark Green

#### LEGEND

G Guard      No. Uniform Number      Pos Playing position      F Forward



## Team Roster

REVISED  
FRI 1 JUL 00:23

As of FRI 1 JUL 2022 at 00:23

### CRO - Croatia

No.	Name	Pos	Height	Date of Birth	Age	Club	Int. Matches
7	RAJCIC Mario	F (3)	2.02 / 6 ' 8 "	27 SEP 2000	22	BC Skrljevo, Skrljevo (CRO)	
9	RADOS Luka	G (1)	1.92 / 6 ' 4 "	11 JUL 1999	22	BC Amfora, Makarska (CRO)	
10	NAKIC-VOJNOVIC Ivan	F (4)	2.05 / 6 ' 9 "	2 MAR 1999	23	BC Dinamo, Zagreb (CRO)	
12	VRGOC Ivan	F (4)	2.05 / 6 ' 9 "	20 SEP 1999	23	BC Skrljevo, Skrljevo (CRO)	
<b>Team averages</b>			2.01 / 6 ' 7 "		22.5		

#### Team Uniform Color

Light White

Dark Red

#### LEGEND

G Guard      No. Uniform Number      Pos Playing position      F Forward



## Team Roster

REVISED  
FRI 1 JUL 00:23

As of FRI 1 JUL 2022 at 00:23

### CYP - Cyprus

No.	Name	Pos	Height	Date of Birth	Age	Club	Int. Matches
4	HIMONAS Andreas		2.00 / 6' 7"	30 MAR 2001	21		
13	PAPADEMETRIOU Nikolaos		1.98 / 6' 6"	20 FEB 2002	20		
14	TRETIAKOV Georgios		2.00 / 6' 7"	10 NOV 2000	21		
77	CONTANTINOOU Marios		2.00 / 6' 7"	22 MAY 2003	19		
Team averages			2.00 / 6' 7"		20.3		

#### Team Uniform Color

Light White

Dark Blue

#### LEGEND

G	Guard	No.	Uniform Number	Pos	Playing position	F	Forward
---	-------	-----	----------------	-----	------------------	---	---------



## Team Roster

REVISED  
FRI 1 JUL 00:23

As of FRI 1 JUL 2022 at 00:23

### EGY - Egypt

No.	Name	Pos	Height	Date of Birth	Age	Club	Int. Matches
8	SAIFELDEEN Mustafa			22 FEB 2002	20		
10	OMAR Aly		1.86 / 6' 1"	12 JUL 1999	22		
35	ELMADAWY Youssef		1.93 / 6' 4"	7 FEB 2001	21		
55	ELMASHAD Hazem		2.05 / 6' 9"	22 FEB 1999	23		
Team averages			1.95 / 6' 5"		21.5		

#### Team Uniform Color

Light	White
Dark	Red

#### LEGEND

G	Guard	No.	Uniform Number	Pos	Playing position	F	Forward
---	-------	-----	----------------	-----	------------------	---	---------





## Team Roster

REVISED  
FRI 1 JUL 00:23

As of FRI 1 JUL 2022 at 00:23

### ESP - Spain

No.	Name	Pos	Height	Date of Birth	Age	Club	Int. Matches
3	MENDICOTE RUBIO Unai	F (3)	2.00 / 6 ' 7 "	30 MAR 1999	23	CIRCULO GIJON, GIJON (ESP)	
7	ARCOS GONZALEZ Guillem	G (2)	1.93 / 6 ' 4 "	23 AUG 2000	22	F. LUCENTUM BALONCESTO ALICANTE, AL	
9	MAYO SCHWANDT Isaac		1.93 / 6 ' 4 "	10 SEP 2001	20		
44	GONZALEZ LONGARELA Pablo	C (5)	1.91 / 6 ' 3 "	9 AUG 2001	20	HESTIA MENORCA, MENORCA (ESP)	
<b>Team averages</b>			1.94 / 6 ' 4 "		21.3		

#### Team Uniform Color

Light White

Dark Red

#### LEGEND

G Guard      No. Uniform Number      Pos Playing position      F Forward



## Team Roster

REVISED  
FRI 1 JUL 00:23

As of FRI 1 JUL 2022 at 00:23

### FRA - France

No.	Name	Pos	Height	Date of Birth	Age	Club	Int. Matches
4	GOMIS Marcus Theotim	G (1/2)		28 FEB 2000	22	Spo Rouen Basketball, Rouen (FRA)	
6	DELAUNAY Leopold Olivier	G (1/2)		14 NOV 2001	21	Jeanne d'Arc Vichy-Clermont Métropole, Vichy	
10	BRUYAS Arthur			9 OCT 2000	21		
17	THIROUARD SAMSON Lorenzo Valentin	F (3/4)		19 FEB 2001	21	Lille Metropole Basket Club, Lille (FRA)	
<b>Team averages</b>					21.3		

#### Team Uniform Color

Light	White
Dark	Blue

#### LEGEND

<b>G</b>	Guard	<b>No.</b>	Uniform Number	<b>Pos</b>	Playing position	<b>F</b>	Forward
----------	-------	------------	----------------	------------	------------------	----------	---------



## Team Roster

REVISED  
FRI 1 JUL 00:23

As of FRI 1 JUL 2022 at 00:23

### GRE - Greece

No.	Name	Pos	Height	Date of Birth	Age	Club	Int. Matches
6	KAPRIS Fotios	G (1/2)	1.92 / 6 ' 4 "	18 MAY 1999	23	POK ESPEROS, KALLITHEA (GRE)	
13	STAVRAKOUKAS Vasileios	G (1/2)	1.94 / 6 ' 4 "	23 JUL 2001	21	PAGKRATI, PAGKRATI (GRE)	
14	KALIANIOTIS Georgios	F (3/4)	2.00 / 6 ' 7 "	17 MAY 2002	20	PALAIIO FALIRO, PALAIIO FALIRO (GRE)	
19	ARNOKOUROS Georgios	F (3/4)	2.03 / 6 ' 8 "	10 DEC 2000	21	MAROUSI, MAROUSI (GRE)	
<b>Team averages</b>			1.97 / 6 ' 6 "		21.3		

#### Team Uniform Color

Light White

Dark Blue

#### LEGEND

G Guard      No. Uniform Number      Pos Playing position      F Forward



## Team Roster

REVISED  
FRI 1 JUL 00:23

As of FRI 1 JUL 2022 at 00:23

### ITA - Italy

No.	Name	Pos	Height	Date of Birth	Age	Club	Int. Matches
3	GALLO Antonio	G (1)		31 JAN 2000	22	VIRTUS POZZUOLI, POZZUOLI (ITA)	
12	VALENTINI Fabio	G (1)		25 AUG 1999	23	NOVIPIU' CASALE MONFERRATO, CASALE	
16	CHINELLATO Riccardo	F (4)		22 JAN 2000	22	PALL. PIACENTINA, PIACENZA (ITA)	
33	SERPILLI Michele	F (3)		12 MAR 1999	23	CEST. SAN SEVERO, SAN SEVERO (ITA)	
<b>Team averages</b>					22.5		

#### Team Uniform Color

Light White

Dark Blue

#### LEGEND

G Guard      No. Uniform Number      Pos Playing position      F Forward



## Team Roster

REVISED  
FRI 1 JUL 00:23

As of FRI 1 JUL 2022 at 00:23

### POR - Portugal

No.	Name	Pos	Height	Date of Birth	Age	Club	Int. Matches
2	GOMES Andre			3 MAR 2000	22		
3	AMADU EMBALO Jorge		1.95 / 6 ' 5 "	20 JUL 1999	23		
15	COSTA PALHARES Rui Manuel		2.04 / 6 ' 8 "	24 DEC 2000	22		
24	DANSO BANORA Lamine		2.00 / 6 ' 7 "	22 OCT 2000	22		
		Team averages	2.00 / 6 ' 7 "		22.3		

#### Team Uniform Color

Light White

Dark Red

#### LEGEND

G Guard      No. Uniform Number      Pos Playing position      F Forward



## Team Roster

REVISED  
FRI 1 JUL 00:23

As of FRI 1 JUL 2022 at 00:23

### SLO - Slovenia

No.	Name	Pos	Height	Date of Birth	Age	Club	Int. Matches
4	GABERSEK Samo		1.92 / 6 ' 4 "	26 MAR 1999	23		
6	GRSIC Jan		1.83 / 6 ' 0 "	14 JAN 1999	23		
9	VIDRIH Rok		1.95 / 6 ' 5 "	26 SEP 1999	23		
32	JANEZIC Blaz		2.06 / 6 ' 9 "	23 FEB 2000	22		
Team averages			1.94 / 6 ' 4 "		22.8		

#### Team Uniform Color

Light White

Dark Blue

#### LEGEND

G Guard      No. Uniform Number      Pos Playing position      F Forward



## Team Roster

REVISED  
FRI 1 JUL 00:23

As of FRI 1 JUL 2022 at 00:23

### SRB - Serbia

No.	Name	Pos	Height	Date of Birth	Age	Club	Int. Matches
8	ANTIC Milos		1.89 / 6 ' 2 "	11 NOV 2000	21		
9	MOMIROV Stefan		1.99 / 6 ' 6 "	18 DEC 1999	23		
10	STANKOVIC Nemanja		1.85 / 6 ' 1 "	25 MAY 2000	22		
13	KOVACEVIC Nikola		1.90 / 6 ' 3 "	12 AUG 1999	22		
Team averages			1.91 / 6 ' 3 "		22.0		

#### Team Uniform Color

Light White

Dark Blue

#### LEGEND

G Guard      No. Uniform Number      Pos Playing position      F Forward



## Team Roster

REVISED  
FRI 1 JUL 00:23

As of FRI 1 JUL 2022 at 00:23

### TUN - Tunisia

No.	Name	Pos	Height	Date of Birth	Age	Club	Int. Matches
1	BEN NJIMA Firas		1.99 / 6' 6"	1 JAN 2000	22		
6	NASR Hassen		2.00 / 6' 7"	27 AUG 1999	23		
24	DALHOUMI Hazem		1.90 / 6' 3"	23 JAN 2001	21		
33	MAHEMLI Housseem		1.91 / 6' 3"	14 FEB 2000	22		
Team averages			1.95 / 6' 5"		22.0		

#### Team Uniform Color

Light White

Dark Red

#### LEGEND

G Guard      No. Uniform Number      Pos Playing position      F Forward





## Team Roster

REVISED  
FRI 1 JUL 00:23

As of FRI 1 JUL 2022 at 00:23

### TUR - Turkiye

No.	Name	Pos	Height	Date of Birth	Age	Club	Int. Matches
8	AVSAR Ismet Baran			25 JAN 1999	23		
13	BAS Goktug			8 MAY 2001	21		
23	IVEDI Cengizhan			1 JUN 1999	23		
26	HALAVURTE Mert			21 JUL 2000	22		
Team averages					22.3		

#### Team Uniform Color

Light	White
Dark	Red

#### LEGEND

G	Guard	No.	Uniform Number	Pos	Playing position	F	Forward
---	-------	-----	----------------	-----	------------------	---	---------



Place Sidi M'Hamed  
3x3 Basketball  
Men  
Preliminary - Group A  
Match 7



THU 30 JUN 2022  
Start time 20:00

Results

Game Duration: 30:05

**TUR 18 vs 19 ALG**  
(17-17; 1-2)

Referee: Najib CHAJIDDINE (FRA)  
Umpires: Maria Giulia FORNI (ITA) Najib CHAJIDDINE (FRA)

Commissioner: Kosta ILIEV (BUL)

OT	
TUR	17
ALG	17
	18
	19

TUR - Turkiye

No.	Name	MIN	PTS	S-EFF	1 Point		2 Points		Free Throws		Rebounds			AS	TO	ST	BS	PF	FD	+/-
					M/A	%	M/A	%	M/A	%	OR	DR	TOT							
*8	AVSAR Ismet Baran	6:48	3	0.25	2/7	29	0/3	0	1/2	50								1	2	1
*13	BAS Goktuğ	8:37	8	0.44	8/11	73	0/2	0	0/5	0								3	3	-5
*23	IVEDI Cencizhan	7:05	5	0.42	4/6	67	0/4	0	1/2	50								4	4	-3
26	HALAVURTE Mert	7:37	0	0.00			0/3	0										1		3
Team			2				1/1	100												
Totals			18	0.39	14/24	58	1/13	8	2/9	22								9	9	

ALG - Algeria

No.	Name	MIN	PTS	S-EFF	1 Point		2 Points		Free Throws		Rebounds			AS	TO	ST	BS	PF	FD	+/-
					M/A	%	M/A	%	M/A	%	OR	DR	TOT							
*5	HIFI Nadir	9:05	12	0.48	3/5	60	2/11	18	5/9	56								1	5	1
6	MEDJOUBI Bacim	7:26	5	1.00	3/3	100	1/2	50			2		2					2		1
*7	TALEB Islam-Nizar	6:39	1	0.25	0/3	0			1/1	100		1	1					5	2	3
*8	BELLIL Mehdi	6:45	1	0.14	0/3	0	0/3	0	1/1	100								2	1	-1
Team																				
Totals			19	0.46	6/14	43	3/16	19	7/11	64	2	1	3					10	8	

	TUR	ALG
Team Fouls	9	10
Teams Fouls at 7	4:14	4:43
Teams Fouls at 10		8:08
Technical Fouls		
Unsportsmanlike Fouls		

	TUR	ALG
Biggest lead	3	4
Biggest scoring run	3-0 (6-7)	6-0 (3-7)
Lead changes	4	

LEGEND

%	Shooting Percentage	*	Game Starters	+/-	Plus Minus	AS	Assists
BS	Blocked Shots	DR	Defensive Rebounds	EFF	Efficiency	FD	Fouls Drawn
M/A	Made/Attempts	MIN	Minutes Played	OR	Offensive Rebounds	PF	Fouls
PTS	Points	ST	Steals	TO	Turnovers	TOT	Total Rebounds



FRI 1 JUL 2022  
Start time 19:00

## Results

Game Duration: 48:52

### ITA 10 vs 21 TUR

Referee: Najib CHAJIDDINE (FRA)  
Umpires: Kahil YACINE (ALG) Najib CHAJIDDINE (FRA)

Commissioner: Kosta ILIEV (BUL)

ITA	10
TUR	21

#### ITA - Italy

No.	Name	MIN	PTS	S-EFF	1 Point		2 Points		Free Throws		Rebounds			AS	TO	ST	BS	PF	FD	+/-
					M/A	%	M/A	%	M/A	%	OR	DR	TOT							
*3	GALLO Antonio	4:50	7	0.50	3/5	60	0/3	0	4/6	67	1	1	2					2	4	-9
*12	VALENTINI Fabio	6:26	1	0.17	1/1	100	0/5	0			2	1	3					1		-12
*16	CHINELLATO Riccardo	6:26	2	0.22	2/6	33	0/2	0	0/1	0	1	2	3					4		-8
*33	SERPILLI Michele	6:12	0	0.00	0/2	0	0/1	0				1	1					1	3	-5
Team																				
Totals			10	0.31	6/14	43	0/11	0	4/7	57	4	5	9					8	7	

#### TUR - Turkiye

No.	Name	MIN	PTS	S-EFF	1 Point		2 Points		Free Throws		Rebounds			AS	TO	ST	BS	PF	FD	+/-
					M/A	%	M/A	%	M/A	%	OR	DR	TOT							
*8	AVSAR Ismet Baran	6:24	4	0.67	0/2	0	2/4	50				1	1	1				2		10
*13	BAS Goktuğ	5:21	7	0.70	4/6	67			3/4	75	1		1					1	6	8
*23	IVEDI Cengizhan	6:03	5	0.71	2/4	50	1/1	100	1/2	50		1	1	1				4		9
*26	HALAVURTE Mert	6:01	4	0.44	1/3	33	1/4	25	1/2	50								1	2	8
Team			1		1/1	100														
Totals			21	0.64	8/16	50	4/9	44	5/8	63	1	2	3	1				8	8	

	ITA	TUR
Team Fouls	8	8
Teams Fouls at 7	5:33	6:38
Teams Fouls at 10		
Technical Fouls		1
Unsportsmanlike Fouls		

	ITA	TUR
Biggest lead		11
Biggest scoring run	2-0 (2-3)	5-0 (10-21)
Lead changes		

#### LEGEND

%	Shooting Percentage	*	Game Starters	+/-	Plus Minus	AS	Assists
BS	Blocked Shots	DR	Defensive Rebounds	EFF	Efficiency	FD	Fouls Drawn
M/A	Made/Attempts	MIN	Minutes Played	OR	Offensive Rebounds	PF	Fouls
PTS	Points	ST	Steals	TO	Turnovers	TOT	Total Rebounds



Place Sidi M'Hamed  
3x3 Basketball  
Men  
Preliminary - Group A  
Match 27



FRI 1 JUL 2022  
Start time 22:20

Results

Game Duration: 22:33

ALG 16 vs 21 ITA

Referee: Vladimir VESKOVIC (SRB)  
Umpires: Najib CHAJIDDINE (FRA) Vladimir VESKOVIC (SRB)

Commissioner: Kosta ILIEV (BUL)

ALG 16  
ITA 21

ALG - Algeria

No.	Name	MIN	PTS	S-EFF	1 Point		2 Points		Free Throws		Rebounds			AS	TO	ST	BS	PF	FD	+/-
					M/A	%	M/A	%	M/A	%	OR	DR	TOT							
*5	HIFI Nadir	9:06	12	0.50	3/6	50	3/12	25	3/6	50		1	1	1					2	-5
6	MEDJOUBI Bacim	6:45	0	0.00			0/1	0	0/1	0		1	1							-5
*7	TALEB Islam-Nizar	6:57	3	0.75	3/4	75						1	1					4	3	
*8	BELLIL Mehdi	7:42	1	0.14	1/3	33	0/2	0	0/2	0				1				1	3	-7
Team																				
Totals			16	0.43	7/13	54	3/15	20	3/9	33		3	3	2				5	5	

ITA - Italy

No.	Name	MIN	PTS	S-EFF	1 Point		2 Points		Free Throws		Rebounds			AS	TO	ST	BS	PF	FD	+/-
					M/A	%	M/A	%	M/A	%	OR	DR	TOT							
*3	GALLO Antonio	9:19	4	0.57	4/6	67	0/1	0										2	5	
12	VALENTINI Fabio	9:27	9	0.75	3/5	60	3/7	43			1		1					3	5	
*16	CHINELLATO Riccardo	7:31	2	0.40	1/4	25			1/1	100		2	2					1	3	5
*33	SERPILLI Michele	7:39	6	0.67	2/3	67	1/3	33	2/3	67	1	3	4					1	2	9
Team																				
Totals			21	0.64	10/18	56	4/11	36	3/4	75	2	5	7					7	5	

	ALG	ITA
Team Fouls	5	7
Teams Fouls at 7		7:32
Teams Fouls at 10		
Technical Fouls		1
Unsportsmanlike Fouls		

	ALG	ITA
Biggest lead		6
Biggest scoring run	4-0 (12-13)	5-0 (12-18)
Lead changes		

LEGEND

%	Shooting Percentage	*	Game Starters	+/-	Plus Minus	AS	Assists
BS	Blocked Shots	DR	Defensive Rebounds	EFF	Efficiency	FD	Fouls Drawn
M/A	Made/Attempts	MIN	Minutes Played	OR	Offensive Rebounds	PF	Fouls
PTS	Points	ST	Steals	TO	Turnovers	TOT	Total Rebounds



Place Sidi M'Hamed  
3x3 Basketball  
Men  
Preliminary - Group B  
Match 8



THU 30 JUN 2022  
Start time 20:20

Results

Game Duration: 26:33

ESP 14 vs 12 POR

Referee: Maria Giulia FORNI (ITA)  
Umpires: Kahil YACINE (ALG) Maria Giulia FORNI (ITA)

Commissioner: Kosta ILIEV (BUL)

ESP 14  
POR 12

ESP - Spain

No.	Name	MIN	PTS	S-EFF	1 Point		2 Points		Free Throws		Rebounds			AS	TO	ST	BS	PF	FD	+/-
					M/A	%	M/A	%	M/A	%	OR	DR	TOT							
*3	MENDICOTE RUBIO Unai	7:19	3	0.27	1/4	25	0/3	0	2/4	50		3	3						2	1
*7	ARCOS GONZALEZ Guillem	8:17	3	0.38	2/6	33	0/1	0	1/1	100		2	2	1				2	1	
9	MAYO SCHWANDT Isaac	7:13	5	0.56	4/6	67	0/1	0	1/2	50	1		1					1	2	
*44	GONZALEZ LONGARELA Pablo	7:09	2	0.25	1/1	100	0/3	0	1/4	25								3	2	5
Team			1		1/1	100												1		
Totals			14	0.38	9/18	50	0/8	0	5/11	45	1	5	6	1				7	7	

POR - Portugal

No.	Name	MIN	PTS	S-EFF	1 Point		2 Points		Free Throws		Rebounds			AS	TO	ST	BS	PF	FD	+/-
					M/A	%	M/A	%	M/A	%	OR	DR	TOT							
*2	GOMES Andre	8:59	5	0.56	0/2	0	2/5	40	1/2	50		1	1					1	1	-2
*3	AMADU EMBALO Jorge	9:18	4	0.29	4/9	44	0/2	0	0/3	0	1	2	3	1				1	4	-3
*15	COSTA PALHARES Rui Manuel	6:26	1	0.14	1/2	50	0/3	0	0/2	0	1	4	5					1	1	-2
24	DANSO BANORA Lamine	5:14	2	0.40	2/5	40												4	1	1
Team																				
Totals			12	0.34	7/18	39	2/10	20	1/7	14	2	7	9	1				7	7	

	ESP	POR
Team Fouls	7	7
Teams Fouls at 7	9:10	7:38
Teams Fouls at 10		
Technical Fouls		
Unsportsmanlike Fouls		

	ESP	POR
Biggest lead	4	2
Biggest scoring run	4-0 (8-6)	3-0 (2-3)
Lead changes	2	

LEGEND

%	Shooting Percentage	*	Game Starters	+/-	Plus Minus	AS	Assists
BS	Blocked Shots	DR	Defensive Rebounds	EFF	Efficiency	FD	Fouls Drawn
M/A	Made/Attempts	MIN	Minutes Played	OR	Offensive Rebounds	PF	Fouls
PTS	Points	ST	Steals	TO	Turnovers	TOT	Total Rebounds



Place Sidi M'Hamed  
3x3 Basketball  
Men  
Preliminary - Group B  
Match 18



FRI 1 JUL 2022  
Start time 19:20

## Results

Game Duration: 22:05

### SLO 5 vs 21 ESP

Referee: Vladimir VESKOVIC (SRB)  
Umpires: Maria Giulia FORNI (ITA) Vladimir VESKOVIC (SRB)

Commissioner: Kosta ILIEV (BUL)

SLO	5
ESP	21

#### SLO - Slovenia

No.	Name	MIN	PTS	S-EFF	1 Point		2 Points		Free Throws		Rebounds			AS	TO	ST	BS	PF	FD	+/-
					M/A	%	M/A	%	M/A	%	OR	DR	TOT							
4	GABERSEK Samo	8:19	1	0.17	1/1	100	0/5	0												-16
6	GRSIC Jan	9:07	3	0.43	1/4	25	1/3	33				1	1					1	3	-16
9	VIDRIH Rok	8:49	1	0.13	1/5	20	0/3	0				3	1	4				2	1	-16
32	JANEZIC Blaz	2:16										1	1	1				2	2	-5
Team			0				0/1	0										1		
Totals			5	0.23	3/10	30	1/12	8				3	3	6	1			6	6	

#### ESP - Spain

No.	Name	MIN	PTS	S-EFF	1 Point		2 Points		Free Throws		Rebounds			AS	TO	ST	BS	PF	FD	+/-
					M/A	%	M/A	%	M/A	%	OR	DR	TOT							
3	MENDICOTE RUBIO Unai	8:03	4	0.31	4/11	36			0/2	0		2	2					3	1	16
7	ARCOS GONZALEZ Guillem	7:08	6	1.00	4/4	100			2/2	100		2		2					3	15
9	MAYO SCHWANDT Isaac	7:13	4	0.80	2/4	50	1/1	100				1		1	1					17
44	GONZALEZ LONGARELA Pablo	7:11	7	0.88	1/3	33	2/3	67	2/2	100		1	1					3	1	16
Team																			1	
Totals			21	0.66	11/22	50	3/4	75	4/6	67		3	3	6	1			6	6	

	SLO	ESP
Team Fouls	6	6
Teams Fouls at 7		
Teams Fouls at 10		
Technical Fouls		
Unsportsmanlike Fouls		

	SLO	ESP
Biggest lead		16
Biggest scoring run	2-0 (4-4)	12-0 (4-16)
Lead changes		

#### LEGEND

%	Shooting Percentage	*	Game Starters	+/-	Plus Minus	AS	Assists
BS	Blocked Shots	DR	Defensive Rebounds	EFF	Efficiency	FD	Fouls Drawn
M/A	Made/Attempts	MIN	Minutes Played	OR	Offensive Rebounds	PF	Fouls
PTS	Points	ST	Steals	TO	Turnovers	TOT	Total Rebounds



Place Sidi M'Hamed  
3x3 Basketball  
Men  
Preliminary - Group B  
Match 28



FRI 1 JUL 2022  
Start time 22:40

Results

Game Duration: 15:57

POR 12 vs 8 SLO

Referee: Vladimir VESKOVIC (SRB)  
Umpires: Maria Giulia FORNI (ITA) Vladimir VESKOVIC (SRB)

Commissioner: Kosta ILIEV (BUL)

POR	12
SLO	8

POR - Portugal

No.	Name	MIN	PTS	S-EFF	1 Point		2 Points		Free Throws		Rebounds			AS	TO	ST	BS	PF	FD	+/-
					M/A	%	M/A	%	M/A	%	OR	DR	TOT							
2	GOMES Andre	8:06	1	0.14	1/3	33	0/3	0	0/1	0		2	2						1	6
*3	AMADU EMBALO Jorge	8:38	3	0.38	3/5	60	0/2	0	0/1	0	1	2	3	3					2	4
*15	COSTA PALHARES Rui Manuel	7:31	5	0.42	4/9	44	0/1	0	1/2	50	2	3	5					1		3
*24	DANSO BANORA Lamine	8:22	3	0.75	2/3	67			1/1	100	1	2	3				1	2	2	4
Team																				
Totals			12	0.39	10/20	50	0/6	0	2/5	40	4	9	13	3			1	3	5	

SLO - Slovenia

No.	Name	MIN	PTS	S-EFF	1 Point		2 Points		Free Throws		Rebounds			AS	TO	ST	BS	PF	FD	+/-
					M/A	%	M/A	%	M/A	%	OR	DR	TOT							
4	GABERSEK Samo	5:59	0	0.00			0/6	0				3	3					1		-4
*6	GRSIC Jan	10:00	4	1.00			2/4	50			1	1	2					2	1	-4
*9	VIDRIH Rok	7:37	1	0.14	1/4	25	0/3	0			2	2	1					2	2	-5
*32	JANEZIC Blaz	9:31	3	0.43	3/4	75	0/2	0	0/1	0	3	2	5					1		-3
Team																				
Totals			8	0.33	4/8	50	2/15	13	0/1	0	4	8	12	1				6	3	

	POR	SLO
Team Fouls	3	6
Teams Fouls at 7		
Teams Fouls at 10		
Technical Fouls		
Unsportsmanlike Fouls		

	POR	SLO
Biggest lead	4	1
Biggest scoring run	3-0 (5-2)	2-0 (5-4)
Lead changes	3	

LEGEND

%	Shooting Percentage	*	Game Starters	+/-	Plus Minus	AS	Assists
BS	Blocked Shots	DR	Defensive Rebounds	EFF	Efficiency	FD	Fouls Drawn
M/A	Made/Attempts	MIN	Minutes Played	OR	Offensive Rebounds	PF	Fouls
PTS	Points	ST	Steals	TO	Turnovers	TOT	Total Rebounds



THU 30 JUN 2022

## Results

Start time: 21:00

Game Duration: 21:41

### SRB 19 vs 16 CYP

Referee: RIBEIRO P. (POR)

Commissioner: Kosta ILIEV (BUL)

Umpires: Aimeur OUSSAMA (ALG) RIBEIRO P. (POR)

SRB	19
CYP	16

#### SRB - Serbia

No.	Name	MIN	PTS	S-EFF	1 Point		2 Points		Free Throws		Rebounds			AS	TO	ST	BS	PF	FD	+/-
					M/A	%	M/A	%	M/A	%	OR	DR	TOT							
8	ANTIC Milos	8:30	4	0.67	4/4	100	0/1	0	0/1	0	1		1					3	3	3
9	MOMIROV Stefan	7:40	2	0.50	2/2	100	0/2	0					4							3
10	STANKOVIC Nemanja	5:45	4	0.67	2/3	67	1/3	33										2	1	2
13	KOVACEVIC Nikola	8:59	9	0.69	5/6	83	1/4	25	2/3	67		1	1	2					3	1
Team																				
Totals			19	0.66	13/15	87	2/10	20	2/4	50	1	1	2	6				5	7	

#### CYP - Cyprus

No.	Name	MIN	PTS	S-EFF	1 Point		2 Points		Free Throws		Rebounds			AS	TO	ST	BS	PF	FD	+/-
					M/A	%	M/A	%	M/A	%	OR	DR	TOT							
*4	HIMONAS Andreas	8:53	2	0.40	2/3	67	0/2	0				1	1	1				3	2	-1
13	PAPADEMETRIOU Nikolaos	6:33	2	0.33	2/4	50	0/2	0			1	2	3						1	2
*14	TRETIKOV Georgios	7:31	3	0.43	1/3	33	1/4	25				1	1					3	1	-6
*77	CONTANTINOU Marios	8:41	9	0.90	1/2	50	4/8	50										1	1	-3
Team																				
Totals			16	0.57	6/12	50	5/16	31			1	4	5	1				7	5	

	SRB	CYP
Team Fouls	5	7
Teams Fouls at 7		9:47
Teams Fouls at 10		
Technical Fouls		
Unsportsmanlike Fouls		

	SRB	CYP
Biggest lead	8	
Biggest scoring run	5-0 (12-4)	3-0 (12-7)
Lead changes		

#### LEGEND

%	Shooting Percentage	*	Game Starters	+/-	Plus Minus	AS	Assists
BS	Blocked Shots	DR	Defensive Rebounds	EFF	Efficiency	FD	Fouls Drawn
M/A	Made/Attempts	MIN	Minutes Played	OR	Offensive Rebounds	PF	Fouls
PTS	Points	ST	Steals	TO	Turnovers	TOT	Total Rebounds





Place Sidi M'Hamed  
3x3 Basketball  
Men  
Preliminary - Group C  
Match 22



FRI 1 JUL 2022  
Start time 20:40

Results

Game Duration: 19:03

FRA 19 vs 21 SRB

Referee: RIBEIRO P. (POR)  
Umpires: Aimeur OUSSAMA (ALG) RIBEIRO P. (POR)

Commissioner: Kosta ILIEV (BUL)

FRA	19
SRB	21

FRA - France

No.	Name	MIN	PTS	S-EFF	1 Point		2 Points		Free Throws		Rebounds			AS	TO	ST	BS	PF	FD	+/-
					M/A	%	M/A	%	M/A	%	OR	DR	TOT							
4	GOMIS Marcus Theotim	6:53	3	0.50	1/4	25	1/2	50			1		1	2				3		
*6	DELAUNAY Leopold Olivier	7:21	5	0.56	0/2	0	1/4	25	3/3	100								3	4	
*10	BRUYAS Arthur	6:29	8	0.80	6/7	86	1/3	33			1	1	2					1	1	1
*17	THIROUARD L.	8:28	3	0.60	0/2	0	1/2	50	1/1	100	1	2	3	1	1			1	3	-2
Team																				
Totals			19	0.63	7/15	47	4/11	36	4/4	100	3	3	6	3	1			8	8	

SRB - Serbia

No.	Name	MIN	PTS	S-EFF	1 Point		2 Points		Free Throws		Rebounds			AS	TO	ST	BS	PF	FD	+/-
					M/A	%	M/A	%	M/A	%	OR	DR	TOT							
*8	ANTIC Milos	6:34	0	0.00	0/1	0	0/1	0	0/1	0	1	1	2					2	1	2
*9	MOMIROV Stefan	8:06	11	0.92	1/2	50	5/10	50										1	2	
10	STANKOVIC Nemanja	6:15	1	0.20			0/3	0	1/2	50		1	1	1				2	2	6
*13	KOVACEVIC Nikola	8:05	9	0.50	4/9	44	1/4	25	3/5	60	2	2	4					3	3	-3
Team																				
Totals			21	0.55	5/12	42	6/18	33	4/8	50	3	4	7	1				8	8	

	FRA	SRB
Team Fouls	8	8
Teams Fouls at 7	8:13	7:00
Teams Fouls at 10		
Technical Fouls		
Unsportsmanlike Fouls		

	FRA	SRB
Biggest lead	2	5
Biggest scoring run	4-0 (4-2)	5-0 (11-16)
Lead changes	4	

LEGEND

%	Shooting Percentage	*	Game Starters	+/-	Plus Minus	AS	Assists
BS	Blocked Shots	DR	Defensive Rebounds	EFF	Efficiency	FD	Fouls Drawn
M/A	Made/Attempts	MIN	Minutes Played	OR	Offensive Rebounds	PF	Fouls
PTS	Points	ST	Steals	TO	Turnovers	TOT	Total Rebounds



Place Sidi M'Hamed  
3x3 Basketball  
Men  
Preliminary - Group C  
Match 30



FRI 1 JUL 2022  
Start time 23:20

Results

Game Duration: 18:29

CYP 3 vs 20 FRA

Referee: RIBEIRO P. (POR)  
Umpires: Benani ANIS (ALG) RIBEIRO P. (POR)

Commissioner: Kosta ILIEV (BUL)

CYP 3  
FRA 20

CYP - Cyprus

No.	Name	MIN	PTS	S-EFF	1 Point		2 Points		Free Throws		Rebounds			AS	TO	ST	BS	PF	FD	+/-
					M/A	%	M/A	%	M/A	%	OR	DR	TOT							
*4	HIMONAS Andreas	7:42	2	0.20	2/7	29	0/3	0				1	1		1			1		-11
13	PAPADEMETRIOU Nikolaos	6:24	1	0.14	1/5	20	0/2	0				1	1					1		-14
*14	TRETIKOV Georgios	9:16	0	0.00	0/3	0	0/2	0	0/1	0		5	5			1		1	2	-15
*77	CONTANTINOU Marios	7:01	0	0.00	0/1	0	0/6	0				2	2					2	1	-11
Team																				
Totals			3	0.10	3/16	19	0/13	0	0/1	0		9	9		1		1	5	3	

FRA - France

No.	Name	MIN	PTS	S-EFF	1 Point		2 Points		Free Throws		Rebounds			AS	TO	ST	BS	PF	FD	+/-
					M/A	%	M/A	%	M/A	%	OR	DR	TOT							
4	GOMIS Marcus Theotim	7:57	4	0.80	2/2	100	1/3	33				1	1	1				1	1	14
*6	DELAUNAY Leopold Olivier	5:42	13	1.08	4/6	67	4/5	80	1/1	100	1	4	5					1	3	12
*10	BRUYAS Arthur	7:46	2	0.25	2/2	100	0/6	0				5	5	1				1	1	13
*17	THIROUARD L.	9:14	1	0.20	1/1	100	0/4	0				5	5	4	1					14
Team																				
Totals			20	0.67	9/11	82	5/18	28	1/1	100	1	15	16	6	1			3	5	

	CYP	FRA
Team Fouls	5	3
Teams Fouls at 7		
Teams Fouls at 10		
Technical Fouls		
Unsportsmanlike Fouls		

	CYP	FRA
Biggest lead		17
Biggest scoring run	1-0 (1-3)	7-0 (3-20)
Lead changes		

LEGEND

%	Shooting Percentage	*	Game Starters	+/-	Plus Minus	AS	Assists
BS	Blocked Shots	DR	Defensive Rebounds	EFF	Efficiency	FD	Fouls Drawn
M/A	Made/Attempts	MIN	Minutes Played	OR	Offensive Rebounds	PF	Fouls
PTS	Points	ST	Steals	TO	Turnovers	TOT	Total Rebounds



Place Sidi M'Hamed  
3x3 Basketball  
Men  
Preliminary - Group D  
Match 3



THU 30 JUN 2022  
Start time 18:40

Results

Game Duration: 24:19

GRE 17 vs 16 CRO

Referee: Aimeur OUSSAMA (ALG)  
Umpires: Aimeur OUSSAMA (ALG) Vladimir VESKOVIC (SRB)

Commissioner: Kosta ILIEV (BUL)

GRE 17  
CRO 16

GRE - Greece

No.	Name	MIN	PTS	S-EFF	1 Point		2 Points		Free Throws		Rebounds			AS	TO	ST	BS	PF	FD	+/-
					M/A	%	M/A	%	M/A	%	OR	DR	TOT							
6	KAPRIS Fotios	6:27	4	0.57	3/5	60			1/2	50	2	1	3	2				4	2	2
*13	STAVRAKOUKAS Vasileios	7:30	7	0.47	7/9	78	0/5	0	0/1	0	2		2	1				2	2	1
*14	KALIANIOTIS Georgios	8:18	4	0.57	4/7	57					2		2					1	2	-1
*19	ARNOKOUIROS Georgios	7:39	2	0.50	2/4	50					1	1	2							1
Team																				
Totals			17	0.52	16/25	64	0/5	0	1/3	33	7	2	9	3				5	6	

CRO - Croatia

No.	Name	MIN	PTS	S-EFF	1 Point		2 Points		Free Throws		Rebounds			AS	TO	ST	BS	PF	FD	+/-
					M/A	%	M/A	%	M/A	%	OR	DR	TOT							
*7	RAJCIC Mario	6:53	6	0.67	4/4	100	1/5	20			1		1	2				1		-1
*9	RADOS Luka	7:57	3	0.50	3/3	100	0/3	0			1	2	3					3	1	-3
10	NAKIC-VOJNOVIC Ivan	8:10	2	0.29	2/5	40	0/2	0			2		2						1	2
*12	VRGOC Ivan	6:56	5	0.83	2/2	100	1/3	33	1/1	100		2	2					3	1	-1
Team																				
Totals			16	0.57	11/14	79	2/13	15	1/1	100	4	4	8	2				7	3	

	GRE	CRO
Team Fouls	5	7
Teams Fouls at 7		8:58
Teams Fouls at 10		
Technical Fouls		
Unsportsmanlike Fouls		

	GRE	CRO
Biggest lead	1	3
Biggest scoring run	4-0 (16-15)	3-0 (4-7)
Lead changes	4	

LEGEND

% Shooting Percentage      \* Game Starters      +/- Plus Minus      AS Assists  
 BS Blocked Shots      DR Defensive Rebounds      EFF Efficiency      FD Fouls Drawn  
 M/A Made/Attempts      MIN Minutes Played      OR Offensive Rebounds      PF Fouls  
 PTS Points      ST Steals      TO Turnovers      TOT Total Rebounds



Place Sidi M'Hamed  
3x3 Basketball  
Men  
Preliminary - Group D  
Match 4



THU 30 JUN 2022  
Start time:19:00

Results

Game Duration:19:01

EGY 10 vs 8 TUN

Referee: Maria Giulia FORNI (ITA)  
Umpires: Kahil YACINE (ALG) Maria Giulia FORNI (ITA)

Commissioner: Kosta ILIEV (BUL)

EGY	10
TUN	8

EGY - Egypt

No.	Name	MIN	PTS	S-EFF	1 Point		2 Points		Free Throws		Rebounds			AS	TO	ST	BS	PF	FD	+/-
					M/A	%	M/A	%	M/A	%	OR	DR	TOT							
*8	SAIFELDEEN Mustafa	7:51	3	0.43	2/4	50	0/2	0	1/1	100			1					4	1	1
*10	OMAR Aly	6:26	1	0.14	1/5	20	0/2	0			1	1	2	1					1	1
35	ELMADAWY Youssef	6:33	2	0.18	0/2	0	1/8	13	0/1	0		1	1	1					1	2
*55	ELMASHAD Hazem	9:15	4	0.67	4/6	67					1	2	3				1	5		2
Team																				
Totals			10	0.32	7/17	41	1/12	8	1/2	50	2	4	6	2			1	9	3	

TUN - Tunisia

No.	Name	MIN	PTS	S-EFF	1 Point		2 Points		Free Throws		Rebounds			AS	TO	ST	BS	PF	FD	+/-
					M/A	%	M/A	%	M/A	%	OR	DR	TOT							
*1	BEN NJIMA Firas	7:51	1	0.25	1/4	25												1		-3
*6	NASR Hassen	8:31	4	0.27	3/6	50	0/8	0	1/1	100	2	2	4					2	3	-2
24	DALHOUMI Hazem	4:46	0	0.00	0/2	0	0/2	0			1		1					1		-2
*33	MAHEMLI Houssef	9:21	3	0.21	0/2	0	0/5	0	3/7	43		4	4	1					4	
Team																				
Totals			8	0.22	4/14	29	0/15	0	4/8	50	3	6	9	1				4	7	

	EGY	TUN
Team Fouls	9	4
Teams Fouls at 7	7:14	
Teams Fouls at 10		
Technical Fouls		
Unsportsmanlike Fouls		

	EGY	TUN
Biggest lead	3	1
Biggest scoring run	3-0 (4-2)	3-0 (4-5)
Lead changes	3	

LEGEND

%	Shooting Percentage	*	Game Starters	+/-	Plus Minus	AS	Assists
BS	Blocked Shots	DR	Defensive Rebounds	EFF	Efficiency	FD	Fouls Drawn
M/A	Made/Attempts	MIN	Minutes Played	OR	Offensive Rebounds	PF	Fouls
PTS	Points	ST	Steals	TO	Turnovers	TOT	Total Rebounds



Place Sidi M'Hamed  
3x3 Basketball  
Men  
Preliminary - Group D  
Match 13



THU 30 JUN 2022  
Start time: 22:00

Results

Game Duration: 21:12

CRO 14 vs 15 TUN

Referee: Najib CHAJIDDINE (FRA)  
Umpires: Yasser EL HAGE (LBN) Najib CHAJIDDINE (FRA)

Commissioner: Kosta ILIEV (BUL)

CRO	14
TUN	15

CRO - Croatia

No.	Name	MIN	PTS	S-EFF	1 Point		2 Points		Free Throws		Rebounds			AS	TO	ST	BS	PF	FD	+/-
					M/A	%	M/A	%	M/A	%	OR	DR	TOT							
*7	RAJCIC Mario	6:34	4	0.57	2/2	100	1/5	20										3	2	-4
*9	RADOS Luka	9:29	6	0.67	2/3	67	1/4	25	2/2	100		1	1	2				2	1	-1
10	NAKIC-VOJNOVIC Ivan	7:17	0	0.00	0/1	0	0/2	0						1					1	
*12	VRGOC Ivan	7:26	4	0.50	2/3	67	1/3	33	0/2	0		1	1					2	1	2
Team																			1	
Totals			14	0.52	6/9	67	3/14	21	2/4	50		2	2	3				7	6	

TUN - Tunisia

No.	Name	MIN	PTS	S-EFF	1 Point		2 Points		Free Throws		Rebounds			AS	TO	ST	BS	PF	FD	+/-
					M/A	%	M/A	%	M/A	%	OR	DR	TOT							
*1	BEN NJIMA Firas	7:17	0	0.00	0/2	0	0/1	0			1	1	2					3	1	-3
*6	NASR Hassen	9:03	4	0.40	4/8	50	0/2	0			1	2	3							
24	DALHOUMI Hazem	3:57	3	1.50			1/1	100	1/1	100		1	1					1	1	5
*33	MAHEMLI Housseem	9:44	8	0.67	1/4	25	2/5	40	3/3	100		3	3					1	5	1
Team																		1		
Totals			15	0.56	5/14	36	3/9	33	4/4	100	2	7	9					6	7	

	CRO	TUN
Team Fouls	7	6
Teams Fouls at 7	6:53	
Teams Fouls at 10		
Technical Fouls		
Unsportsmanlike Fouls		

	CRO	TUN
Biggest lead	2	5
Biggest scoring run	4-0 (12-13)	4-0 (2-4)
Lead changes		1

LEGEND

%	Shooting Percentage	*	Game Starters	+/-	Plus Minus	AS	Assists
BS	Blocked Shots	DR	Defensive Rebounds	EFF	Efficiency	FD	Fouls Drawn
M/A	Made/Attempts	MIN	Minutes Played	OR	Offensive Rebounds	PF	Fouls
PTS	Points	ST	Steals	TO	Turnovers	TOT	Total Rebounds



Place Sidi M'Hamed  
3x3 Basketball  
Men  
Preliminary - Group D  
Match 14



THU 30 JUN 2022  
Start time 22:20

Results

Game Duration: 19:50

GRE 18 vs 15 EGY

Referee: Vladimir VESKOVIC (SRB)  
Umpires: Aimeur OUSSAMA (ALG) Vladimir VESKOVIC (SRB)

Commissioner: Kosta ILIEV (BUL)

GRE 18  
EGY 15

GRE - Greece

No.	Name	MIN	PTS	S-EFF	1 Point		2 Points		Free Throws		Rebounds			AS	TO	ST	BS	PF	FD	+/-
					M/A	%	M/A	%	M/A	%	OR	DR	TOT							
6	KAPRIS Fotios	6:17	1	0.17	1/4	25	0/2	0			1	1	1					1		-2
*13	STAVRAKOUKAS Vasileios	7:44	9	0.56	2/6	33	2/6	33	3/4	75	1	1	2	1					4	5
*14	KALIANIOTIS Georgios	7:38	5	0.63	2/3	67	0/1	0	3/4	75	1	3	4					1	3	5
*19	ARNOKOUROS Georgios	8:19	3	0.75	1/2	50	1/2	50				3	3						2	1
Team																				
Totals			18	0.53	6/15	40	3/11	27	6/8	75	3	7	10	2				2	9	

EGY - Egypt

No.	Name	MIN	PTS	S-EFF	1 Point		2 Points		Free Throws		Rebounds			AS	TO	ST	BS	PF	FD	+/-
					M/A	%	M/A	%	M/A	%	OR	DR	TOT							
*8	SAIFELDEEN Mustafa	5:30	4	0.80	1/3	33	1/1	100	1/1	100		1	1					4	1	
*10	OMAR Aly	8:34	6	0.60	4/4	100	1/6	17				5	5	1				2	1	-3
35	ELMADAWY Youssef	6:48	4	0.44	0/2	0	2/7	29			2		2							-1
*55	ELMASHAD Hazem	9:09	1	0.50	1/2	50						1	1	1				2		-5
Team																		1		
Totals			15	0.58	6/11	55	4/14	29	1/1	100	2	7	9	2				9	2	

	GRE	EGY
Team Fouls	2	9
Teams Fouls at 7		7:27
Teams Fouls at 10		
Technical Fouls		
Unsportsmanlike Fouls		

	GRE	EGY
Biggest lead	3	4
Biggest scoring run	4-0 (18-15)	6-0 (8-11)
Lead changes	3	

LEGEND

% Shooting Percentage      \* Game Starters      +/- Plus Minus      AS Assists  
 BS Blocked Shots      DR Defensive Rebounds      EFF Efficiency      FD Fouls Drawn  
 M/A Made/Attempts      MIN Minutes Played      OR Offensive Rebounds      PF Fouls  
 PTS Points      ST Steals      TO Turnovers      TOT Total Rebounds



Place Sidi M'Hamed  
3x3 Basketball  
Men  
Preliminary - Group D  
Match 23



FRI 1 JUL 2022  
Start time 21:00

## Results

Game Duration: 20:24

### CRO 17 vs 12 EGY

Referee: RIBEIRO P. (POR)  
Umpires: Benani ANIS (ALG) RIBEIRO P. (POR)

Commissioner: Kosta ILIEV (BUL)

<b>CRO</b>	17
<b>EGY</b>	12

#### CRO - Croatia

No.	Name	MIN	PTS	S-EFF	1 Point		2 Points		Free Throws		Rebounds			AS	TO	ST	BS	PF	FD	+/-
					M/A	%	M/A	%	M/A	%	OR	DR	TOT							
*7	RAJCIC Mario	8:19	5	0.42	3/6	50	1/6	17			3		3	1	1			2	2	4
*9	RADOS Luka	7:56	2	0.22	1/5	20	0/2	0	1/2	50	2		2					1	1	6
10	NAKIC-VOJNOVIC Ivan	6:11	0	0.00			0/1	0	0/2	0	1		1					1	3	3
*12	VRGOC Ivan	8:49	10	0.77	4/4	100	2/6	33	2/3	67		3	3					2	3	6
Team																				
Totals			17	0.46	8/15	53	3/15	20	3/7	43	6	3	9	1	1			6	9	

#### EGY - Egypt

No.	Name	MIN	PTS	S-EFF	1 Point		2 Points		Free Throws		Rebounds			AS	TO	ST	BS	PF	FD	+/-
					M/A	%	M/A	%	M/A	%	OR	DR	TOT							
*8	SAIFELDEEN Mustafa	3:38	3	0.27	2/7	29	0/1	0	1/3	33	2	1	3					1	2	1
*10	OMAR Aly	9:01	4	0.57	3/4	75	0/2	0	1/1	100		1	1					3	1	-6
35	ELMADAWY Youssef	9:03	4	0.44	4/5	80	0/4	0				1	1	1				4	2	-6
*55	ELMASHAD Hazem	8:28	1	0.25	0/2	0			1/2	50		1	1					1	1	-4
Team																				
Totals			12	0.39	9/18	50	0/7	0	3/6	50	2	4	6	1				9	6	

	CRO	EGY
Team Fouls	6	9
Teams Fouls at 7		5:51
Teams Fouls at 10		
Technical Fouls		
Unsportsmanlike Fouls		

	CRO	EGY
Biggest lead	6	1
Biggest scoring run	3-0 (5-2)	2-0 (10-6)
Lead changes	2	

#### LEGEND

%	Shooting Percentage	*	Game Starters	+/-	Plus Minus	AS	Assists
BS	Blocked Shots	DR	Defensive Rebounds	EFF	Efficiency	FD	Fouls Drawn
M/A	Made/Attempts	MIN	Minutes Played	OR	Offensive Rebounds	PF	Fouls
PTS	Points	ST	Steals	TO	Turnovers	TOT	Total Rebounds



FRI 1 JUL 2022  
Start time 21:20

## Results

Game Duration: 26:24

### TUN 13 vs 17 GRE

Referee: Najib CHAJIDDINE (FRA)  
Umpires: Maria Giulia FORNI (ITA) Najib CHAJIDDINE (FRA)

Commissioner: Kosta ILIEV (BUL)

TUN	13
GRE	17

#### TUN - Tunisia

No.	Name	MIN	PTS	S-EFF	1 Point		2 Points		Free Throws		Rebounds			AS	TO	ST	BS	PF	FD	+/-
					M/A	%	M/A	%	M/A	%	OR	DR	TOT							
*1	BEN NJIMA Firas	7:24	2	0.50	2/4	50								1				3	2	-5
*6	NASR Hassen	9:11	8	0.73	3/4	75	2/6	33	1/1	100	2	1	3					6	6	-2
24	DALHOUMI Hazem	4:22	0	0.00	0/2	0	0/2	0			1	1	2	1				2		-1
*33	MAHEMLI Housseem	9:18	3	0.25	1/5	20	0/5	0	2/2	100	2	3	5	1				2	1	-3
Team																				
Totals			13	0.42	6/15	40	2/13	15	3/3	100	5	5	10	3				13	9	

#### GRE - Greece

No.	Name	MIN	PTS	S-EFF	1 Point		2 Points		Free Throws		Rebounds			AS	TO	ST	BS	PF	FD	+/-
					M/A	%	M/A	%	M/A	%	OR	DR	TOT							
6	KAPRIS Fotios	8:09	3	0.38	2/6	33			1/2	50	1	1	2		1			1	2	4
*13	STAVRAKOUKAS Vasileios	8:20	8	0.42	4/11	36	1/5	20	2/3	67	1	1	2					4	2	3
*14	KALIANIOTIS Georgios	5:50	3	0.27	0/5	0			3/6	50	2		2		1			5	6	3
*19	ARNOKOUROS Georgios	8:21	3	0.60	1/1	100			2/4	50	1	3	4	1					3	4
Team																		1		
Totals			17	0.40	7/23	30	1/5	20	8/15	53	5	5	10	1	2			11	13	

	TUN	GRE
Team Fouls	13	11
Teams Fouls at 7	2:54	5:31
Teams Fouls at 10	4:19	9:04
Technical Fouls		1
Unsportsmanlike Fouls		1

	TUN	GRE
Biggest lead	1	6
Biggest scoring run	2-0 (2-2)	4-0 (9-14)
Lead changes		1

#### LEGEND

%	Shooting Percentage	*	Game Starters	+/-	Plus Minus	AS	Assists
BS	Blocked Shots	DR	Defensive Rebounds	EFF	Efficiency	FD	Fouls Drawn
M/A	Made/Attempts	MIN	Minutes Played	OR	Offensive Rebounds	PF	Fouls
PTS	Points	ST	Steals	TO	Turnovers	TOT	Total Rebounds





Place Sidi M'Hamed  
3x3 Basketball  
Men  
Quarter-finals  
Match 36



SAT 2 JUL 2022  
Start time 20:40

Results

Game Duration: 24:07

TUR 18 vs 14 POR

Referee: Najib CHAJIDDINE (FRA)  
Umpires: Maria Giulia FORNI (ITA) Najib CHAJIDDINE (FRA)

Commissioner: Kosta ILIEV (BUL)

TUR 18  
POR 14

TUR - Turkiye

No.	Name	MIN	PTS	S-EFF	1 Point		2 Points		Free Throws		Rebounds			AS	TO	ST	BS	PF	FD	+/-
					M/A	%	M/A	%	M/A	%	OR	DR	TOT							
*8	AVSAR Ismet Baran	8:24	8	0.50	1/6	17	3/6	50	1/4	25	3	1	4	2					3	3
*13	BAS Goktuğ	9:02	7	0.70	7/10	70					2	2	4		1			1	1	5
*23	IVEDI Cencizhan	5:46	3	0.38	1/3	33	0/2	0	2/3	67	2	2	4			1		4	4	3
26	HALAVURTE Mert	6:51	0	0.00			0/1	0			2		2		2	1		2	1	2
Team																				
Totals			18	0.51	9/19	47	3/9	33	3/7	43	9	5	14	2	3	2		7	9	

POR - Portugal

No.	Name	MIN	PTS	S-EFF	1 Point		2 Points		Free Throws		Rebounds			AS	TO	ST	BS	PF	FD	+/-
					M/A	%	M/A	%	M/A	%	OR	DR	TOT							
2	GOMES Andre	7:41	5	0.42	2/3	67	1/7	14	1/2	50	5		5					3	2	-4
*3	AMADU EMBALO Jorge	8:58	1	0.14	1/3	33	0/3	0	0/1	0	5	2	7	1	4	1		1	2	-3
*15	COSTA PALHARES Rui Manuel	8:13	4	0.31	2/5	40	0/5	0	2/3	67	3	3	6					3	2	-4
*24	DANSO BANORA Lamine	5:08	4	0.67	3/4	75	0/1	0	1/1	100	1	1	2					2	1	-1
Team																				
Totals			14	0.37	8/15	53	1/16	6	4/7	57	14	6	20	1	4	1		9	7	

	TUR	POR
Team Fouls	7	9
Teams Fouls at 7	7:57	9:19
Teams Fouls at 10		
Technical Fouls		
Unsportsmanlike Fouls		

	TUR	POR
Biggest lead	4	1
Biggest scoring run	3-0 (4-2)	3-0 (14-13)
Lead changes	2	

LEGEND

% Shooting Percentage      \* Game Starters      +/- Plus Minus      AS Assists  
 BS Blocked Shots      DR Defensive Rebounds      EFF Efficiency      FD Fouls Drawn  
 M/A Made/Attempts      MIN Minutes Played      OR Offensive Rebounds      PF Fouls  
 PTS Points      ST Steals      TO Turnovers      TOT Total Rebounds



Place Sidi M'Hamed  
3x3 Basketball  
Men  
Quarter-finals  
Match 41



SAT 2 JUL 2022  
Start time 22:20

Results

Game Duration: 22:36

GRE 20 vs 22 FRA

Referee: Vladimir VESKOVIC (SRB)  
Umpires: Aimeur OUSSAMA (ALG) Vladimir VESKOVIC (SRB)

Commissioner: Kosta ILIEV (BUL)

GRE 20  
FRA 22

GRE - Greece

No.	Name	MIN	PTS	S-EFF	1 Point		2 Points		Free Throws		Rebounds			AS	TO	ST	BS	PF	FD	+/-
					M/A	%	M/A	%	M/A	%	OR	DR	TOT							
6	KAPRIS Fotios	6:16	3	0.60	3/5	60					3	3	4					1	1	3
*13	STAVRAKOUKAS Vasileios	5:59	4	0.40	4/7	57	0/3	0			3	3		4					1	-5
*14	KALIANIOTIS Georgios	7:11	12	0.67	4/9	44			8/9	89	2	2		2				4	8	2
*19	ARNOKOUROS Georgios	7:57	1	0.25	1/3	33	0/1	0			1	2	3					3		-2
Team																				
Totals			20	0.54	12/24	50	0/4	0	8/9	89	1	10	11	4	6			8	10	

FRA - France

No.	Name	MIN	PTS	S-EFF	1 Point		2 Points		Free Throws		Rebounds			AS	TO	ST	BS	PF	FD	+/-
					M/A	%	M/A	%	M/A	%	OR	DR	TOT							
4	GOMIS Marcus Theotim	5:32	2	0.50	2/3	67	0/1	0			1	1	1	1	1			2		3
*6	DELAUNAY Leopold Olivier	6:43	10	0.91	3/6	50	3/3	100	1/2	50	2	2		2	1	1	1	3	3	3
*10	BRUYAS Arthur	6:54	3	0.60	1/2	50	1/3	33			1	1			1			5	2	-3
*17	THIROUARD L.	8:05	7	0.50	1/4	25	2/5	40	2/5	40	4	4	2			1			3	
Team																				
Totals			22	0.65	7/15	47	6/12	50	3/7	43	1	7	8	3	3	2	2	10	8	

	GRE	FRA
Team Fouls	8	10
Teams Fouls at 7	8:11	5:24
Teams Fouls at 10		8:14
Technical Fouls		
Unsportsmanlike Fouls		

	GRE	FRA
Biggest lead	3	7
Biggest scoring run	5-0 (10-12)	4-0 (2-7)
Lead changes	2	

LEGEND

%	Shooting Percentage	*	Game Starters	+/-	Plus Minus	AS	Assists
BS	Blocked Shots	DR	Defensive Rebounds	EFF	Efficiency	FD	Fouls Drawn
M/A	Made/Attempts	MIN	Minutes Played	OR	Offensive Rebounds	PF	Fouls
PTS	Points	ST	Steals	TO	Turnovers	TOT	Total Rebounds



Place Sidi M'Hamed  
3x3 Basketball  
Men  
Quarter-finals  
Match 40



SAT 2 JUL 2022  
Start time 22:00

Results

Game Duration: 20:13

ESP 21 vs 18 ALG

Referee: Vladimir VESKOVIC (SRB)  
Umpires: Maria Giulia FORNI (ITA) Vladimir VESKOVIC (SRB)

Commissioner: Kosta ILIEV (BUL)

ESP	21
ALG	18

ESP - Spain

No.	Name	MIN	PTS	S-EFF	1 Point		2 Points		Free Throws		Rebounds			AS	TO	ST	BS	PF	FD	+/-
					M/A	%	M/A	%	M/A	%	OR	DR	TOT							
*3	MENDICOTE RUBIO Unai	7:17	9	0.90	5/5	100	2/4	50	0/1	0	1	1			1				2	7
*7	ARCOS GONZALEZ Guillem	7:02	4	0.57	2/3	67	1/4	25			1	4	5	1	2			3		2
*9	MAYO SCHWANDT Isaac	5:55	4	0.50	3/5	60	0/1	0	1/2	50	1	1	2	1	1			2	1	
44	GONZALEZ LONGARELA Pablo	6:49	4	0.40	2/2	100	0/5	0	2/3	67	2		2	1				2	4	
Team																				
Totals			21	0.60	12/15	80	3/14	21	3/6	50	3	6	9	4	3	2		7	7	

ALG - Algeria

No.	Name	MIN	PTS	S-EFF	1 Point		2 Points		Free Throws		Rebounds			AS	TO	ST	BS	PF	FD	+/-
					M/A	%	M/A	%	M/A	%	OR	DR	TOT							
*5	HIFI Nadir	7:33	11	0.85	4/5	80	3/7	43	1/1	100		1	1		1			1	2	-2
*6	MEDJOUBI Bacim	5:41	0	0.00	0/1	0	0/4	0				3	3		2			1		
*7	TALEB Islam-Nizar	6:27	0	0.00	0/3	0					3	5	8		2		1	4	2	-5
8	BELLIL Mehdi	7:11	7	0.58	1/4	25	3/5	60	0/3	0	3	1	4			1		1	3	-2
Team																				
Totals			18	0.55	5/13	38	6/16	38	1/4	25	6	10	16		5	1	1	7	7	

	ESP	ALG
Team Fouls	7	7
Teams Fouls at 7	8:15	8:03
Teams Fouls at 10		
Technical Fouls		
Unsportsmanlike Fouls		

	ESP	ALG
Biggest lead	3	3
Biggest scoring run	3-0 (9-9)	4-0 (6-9)
Lead changes	8	

LEGEND

%	Shooting Percentage	*	Game Starters	+/-	Plus Minus	AS	Assists
BS	Blocked Shots	DR	Defensive Rebounds	EFF	Efficiency	FD	Fouls Drawn
M/A	Made/Attempts	MIN	Minutes Played	OR	Offensive Rebounds	PF	Fouls
PTS	Points	ST	Steals	TO	Turnovers	TOT	Total Rebounds



Place Sidi M'Hamed  
3x3 Basketball  
Men  
Quarter-finals  
Match 37



SAT 2 JUL 2022  
Start time 21:00

Results

Game Duration: 24:20

SRB 17 vs 14 CRO

Referee: RIBEIRO P. (POR)  
Umpires: Kahil YACINE (ALG) RIBEIRO P. (POR)

Commissioner: Kosta ILIEV (BUL)

SRB	17
CRO	14

SRB - Serbia

No.	Name	MIN	PTS	S-EFF	1 Point		2 Points		Free Throws		Rebounds			AS	TO	ST	BS	PF	FD	+/-
					M/A	%	M/A	%	M/A	%	OR	DR	TOT							
*8	ANTIC Milos	7:50	5	0.56	4/7	57			1/2	50	2	1	3					3	2	4
*9	MOMIROV Stefan	7:16	5	0.38	2/3	67	0/5	0	3/5	60	1	1	2	2		1		2	3	3
10	STANKOVIC Nemanja	7:06	0	0.00	0/2	0	0/5	0			1	2	3	1	2			3		1
*13	KOVACEVIC Nikola	7:56	7	0.50	3/7	43	1/1	100	2/6	33		3	3						5	3
Team																				
Totals			17	0.40	9/19	47	1/11	9	6/13	46	4	7	11	3	2	1		8	10	

CRO - Croatia

No.	Name	MIN	PTS	S-EFF	1 Point		2 Points		Free Throws		Rebounds			AS	TO	ST	BS	PF	FD	+/-
					M/A	%	M/A	%	M/A	%	OR	DR	TOT							
*7	RAJIC Mario	6:55	0	0.00			0/1	0				2	2	3	2				1	-6
*9	RADOS Luka	6:37	3	0.30	1/4	25	0/4	0	2/2	100		5	5	1		2		4	2	-1
10	NAKIC-VOJNOVIC Ivan	7:47	5	0.50	2/7	29	1/2	50	1/1	100	3	2	5	1				3	2	-3
*12	VRGOC Ivan	8:38	6	0.67	4/6	67	1/3	33				3	3		2			4	3	-2
Team																				
Totals			14	0.47	7/17	41	2/10	20	3/3	100	3	12	15	5	4	2		11	8	

	SRB	CRO
Team Fouls	8	11
Teams Fouls at 7	9:22	7:44
Teams Fouls at 10		8:44
Technical Fouls		1
Unsportsmanlike Fouls		

	SRB	CRO
Biggest lead	6	2
Biggest scoring run	4-0 (17-11)	3-0 (17-14)
Lead changes	4	

LEGEND

%	Shooting Percentage	*	Game Starters	+/-	Plus Minus	AS	Assists
BS	Blocked Shots	DR	Defensive Rebounds	EFF	Efficiency	FD	Fouls Drawn
M/A	Made/Attempts	MIN	Minutes Played	OR	Offensive Rebounds	PF	Fouls
PTS	Points	ST	Steals	TO	Turnovers	TOT	Total Rebounds



SUN 3 JUL 2022  
Start time 18:10

## Results

Game Duration: 17:17

### TUR 12 vs 15 FRA

Referee: Vladimir VESKOVIC (SRB)  
Umpires: Maria Giulia FORNI (ITA) Vladimir VESKOVIC (SRB)

Commissioner: Kosta ILIEV (BUL)

TUR 12  
FRA 15

#### TUR - Turkiye

No.	Name	MIN	PTS	S-EFF	1 Point		2 Points		Free Throws		Rebounds			AS	TO	ST	BS	PF	FD	+/-
					M/A	%	M/A	%	M/A	%	OR	DR	TOT							
*8	AVSAR Ismet Baran	7:48	3	0.50	3/6	50					2	2	1	1						-1
*13	BAS Goktuğ	8:11	3	0.30	3/10	30					4	3	7						3	-2
*23	IVEDI Cengizhan	8:51	5	0.38	5/8	63	0/4	0	0/1	0	4	2	6		3			3	2	-2
26	HALAVURTE Mert	4:55	1	0.33	1/2	50	0/1	0			1	4	5	2	1			2	1	-3
Team																				
Totals			12	0.38	12/26	46	0/5	0	0/1	0	9	11	20	3	5			5	6	

#### FRA - France

No.	Name	MIN	PTS	S-EFF	1 Point		2 Points		Free Throws		Rebounds			AS	TO	ST	BS	PF	FD	+/-
					M/A	%	M/A	%	M/A	%	OR	DR	TOT							
4	GOMIS Marcus Theotim	7:02	1	0.33	1/1	100	0/2	0			1	1	2					1		2
*6	DELAUNAY Leopold Olivier	6:40	5	0.63	2/3	67	1/4	25	1/1	100	3	3	3	2				2	2	6
*10	BRUYAS Arthur	6:53	4	0.36	1/5	20	1/5	20	1/1	100	3	3	6	1	3			1	2	1
*17	THIROUARD L.	9:32	5	0.33	5/9	56	0/6	0			1	1	2					2	1	
Team																				
Totals			15	0.41	9/18	50	2/17	12	2/2	100	5	8	13	3	3			6	5	

	TUR	FRA
Team Fouls	5	6
Teams Fouls at 7		
Teams Fouls at 10		
Technical Fouls		
Unsportsmanlike Fouls		

	TUR	FRA
Biggest lead	1	3
Biggest scoring run	2-0 (4-3)	2-0 (2-3)
Lead changes	4	

#### LEGEND

%	Shooting Percentage	*	Game Starters	+/-	Plus Minus	AS	Assists
BS	Blocked Shots	DR	Defensive Rebounds	EFF	Efficiency	FD	Fouls Drawn
M/A	Made/Attempts	MIN	Minutes Played	OR	Offensive Rebounds	PF	Fouls
PTS	Points	ST	Steals	TO	Turnovers	TOT	Total Rebounds



Place Sidi M'Hamed  
3x3 Basketball  
Men  
Semi-finals  
Match 48



SUN 3 JUL 2022  
Start time 18:30

Results

Game Duration: 17:47

ESP 13 vs 21 SRB

Referee: Najib CHAJIDDINE (FRA)  
Umpires: RIBEIRO P. (POR) Najib CHAJIDDINE (FRA)

Commissioner: Kosta ILIEV (BUL)

ESP	13
SRB	21

ESP - Spain

No.	Name	MIN	PTS	S-EFF	1 Point		2 Points		Free Throws		Rebounds			AS	TO	ST	BS	PF	FD	+/-
					M/A	%	M/A	%	M/A	%	OR	DR	TOT							
*3	MENDICOTE RUBIO Unai	7:30	4	0.50	4/8	50					1	1	2	1	1	2		2	1	-9
*7	ARCOS GONZALEZ Guillem	6:05	3	0.33	1/6	17	1/2	50	0/1	0	1	4	5	1	1	2			2	-5
9	MAYO SCHWANDT Isaac	6:38	3	0.60	3/4	75			0/1	0	1	1	1	3		1	1	1	2	-7
*44	GONZALEZ LONGARELA Pablo	7:48	3	0.50	1/2	50	1/4	25				2	2			1		4	1	-6
Team																				
Totals			13	0.46	9/20	45	2/6	33	0/2	0	3	7	10	3	5	5	1	7	6	

SRB - Serbia

No.	Name	MIN	PTS	S-EFF	1 Point		2 Points		Free Throws		Rebounds			AS	TO	ST	BS	PF	FD	+/-
					M/A	%	M/A	%	M/A	%	OR	DR	TOT							
*8	ANTIC Milos	6:03	7	0.64	6/7	86			1/4	25	1	1	2		1			1	3	6
*9	MOMIROV Stefan	6:42	3	0.50	1/1	100	1/5	20				4	4	3	2				1	4
10	STANKOVIC Nemanja	6:23	5	0.83	1/1	100	2/5	40				2	2	2	2	1		3		7
*13	KOVACEVIC Nikola	8:17	6	1.50	2/2	100	2/2	100				2	2	3	3			2	3	7
Team																				
Totals			21	0.78	10/11	91	5/12	42	1/4	25	1	9	10	8	8	1		6	7	

	ESP	SRB
Team Fouls	7	6
Teams Fouls at 7	6:46	
Teams Fouls at 10		
Technical Fouls		
Unsportsmanlike Fouls		

	ESP	SRB
Biggest lead		10
Biggest scoring run	3-0 (6-13)	6-0 (0-6)
Lead changes		

LEGEND

%	Shooting Percentage	*	Game Starters	+/-	Plus Minus	AS	Assists
BS	Blocked Shots	DR	Defensive Rebounds	EFF	Efficiency	FD	Fouls Drawn
M/A	Made/Attempts	MIN	Minutes Played	OR	Offensive Rebounds	PF	Fouls
PTS	Points	ST	Steals	TO	Turnovers	TOT	Total Rebounds



Place Sidi M'Hamed  
3x3 Basketball  
Men  
Semifinals 5-8  
Match 51



SUN 3 JUL 2022  
Start time 19:30

Results

Game Duration: 23:44

POR 19 vs 17 GRE

Referee: Vladimir VESKOVIC (SRB)  
Umpires: Maria Giulia FORNI (ITA) Vladimir VESKOVIC (SRB)

Commissioner: Kosta ILIEV (BUL)

POR 19  
GRE 17

POR - Portugal

No.	Name	MIN	PTS	S-EFF	1 Point		2 Points		Free Throws		Rebounds			AS	TO	ST	BS	PF	FD	+/-
					M/A	%	M/A	%	M/A	%	OR	DR	TOT							
2	GOMES Andre	6:26	3	0.60	1/2	50	0/1	0	2/2	100		1	1					3	2	-4
*3	AMADU EMBALO Jorge	9:12	3	0.25	1/5	20	0/4	0	2/3	67				1				1	2	2
*15	COSTA PALHARES Rui Manuel	9:02	9	0.64	5/10	50	1/1	100	2/3	67		3	3					1	4	2
*24	DANSO BANORA Lamine	5:54	4	0.44	0/2	0	0/1	0	4/6	67		3	3	1				2	3	8
Team																				
Totals			19	0.48	7/19	37	1/7	14	10/14	71		7	7	2				7	11	

GRE - Greece

No.	Name	MIN	PTS	S-EFF	1 Point		2 Points		Free Throws		Rebounds			AS	TO	ST	BS	PF	FD	+/-
					M/A	%	M/A	%	M/A	%	OR	DR	TOT							
*6	KAPRIS Fotios	7:13	0	0.00	0/3	0						2	2					7		-8
13	STAVRAKOUKAS Vasileios	7:33	5	0.71	1/4	25	2/2	100	0/1	0		1	1	1					1	1
*14	KALIANIOTIS Georgios	6:33	5	0.45	2/6	33			3/5	60								1	5	
*19	ARNOKOUROS Georgios	9:00	7	0.64	3/6	50	1/2	50	2/3	67	1	4	5					3	1	2
Team																				
Totals			17	0.53	6/19	32	3/4	75	5/9	56	1	7	8	1				11	7	

	POR	GRE
Team Fouls	7	11
Teams Fouls at 7	9:00	4:31
Teams Fouls at 10		9:56
Technical Fouls		
Unsportsmanlike Fouls		

	POR	GRE
Biggest lead	4	3
Biggest scoring run	5-0 (19-17)	7-0 (13-16)
Lead changes	7	

LEGEND

%	Shooting Percentage	*	Game Starters	+/-	Plus Minus	AS	Assists
BS	Blocked Shots	DR	Defensive Rebounds	EFF	Efficiency	FD	Fouls Drawn
M/A	Made/Attempts	MIN	Minutes Played	OR	Offensive Rebounds	PF	Fouls
PTS	Points	ST	Steals	TO	Turnovers	TOT	Total Rebounds



SUN 3 JUL 2022  
Start time 19:50

## Results

Game Duration: 24:31

### ALG 17 vs 15 CRO (15-15; 2-0)

Referee: Najib CHAJIDDINE (FRA)

Commissioner: Kosta ILIEV (BUL)

Umpires: RIBEIRO P. (POR) Najib CHAJIDDINE (FRA)

OT

ALG	15	17
CRO	15	15

#### ALG - Algeria

No.	Name	MIN	PTS	S-EFF	1 Point		2 Points		Free Throws		Rebounds			AS	TO	ST	BS	PF	FD	+/-
					M/A	%	M/A	%	M/A	%	OR	DR	TOT							
*5	HIFI Nadir	8:27	12	0.52	3/10	30	2/7	29	5/6	83		2	2					3	7	6
*6	MEDJOUBI Bacim	8:13	1	0.25			0/3	0	1/1	100	1	2	3						1	1
*7	TALEB Islam-Nizar	7:51	4	0.67	4/6	67					1	5	6	1				5	1	3
8	BELLIL Mehdi	6:11	0	0.00	0/1	0	0/4	0					3					1	1	-2
Team																				
Totals			17	0.45	7/17	41	2/14	14	6/7	86	5	9	14	1				9	10	

#### CRO - Croatia

No.	Name	MIN	PTS	S-EFF	1 Point		2 Points		Free Throws		Rebounds			AS	TO	ST	BS	PF	FD	+/-
					M/A	%	M/A	%	M/A	%	OR	DR	TOT							
*7	RAJCIC Mario	9:50	4	0.36	2/3	67	0/6	0	2/2	100	2	1	3	1				2	4	
9	RADOS Luka	7:33	1	0.33	1/1	100	0/2	0			1	1	2					2		1
*10	NAKIC-VOJNOVIC Ivan	6:14	5	0.50	1/3	33	1/3	33	2/4	50		1	1					2	3	-4
*12	VRGOC Ivan	8:09	5	0.38	1/4	25	2/8	25	0/1	0		2	2					4	2	1
Team																				
Totals			15	0.41	5/11	45	3/19	16	4/7	57	3	5	8	1				10	9	

	ALG	CRO
Team Fouls	9	10
Teams Fouls at 7	7:38	6:51
Teams Fouls at 10		8:27
Technical Fouls		
Unsportsmanlike Fouls		

	ALG	CRO
Biggest lead	3	4
Biggest scoring run	4-0 (12-11)	7-0 (4-8)
Lead changes	3	

#### LEGEND

%	Shooting Percentage	*	Game Starters	+/-	Plus Minus	AS	Assists
BS	Blocked Shots	DR	Defensive Rebounds	EFF	Efficiency	FD	Fouls Drawn
M/A	Made/Attempts	MIN	Minutes Played	OR	Offensive Rebounds	PF	Fouls
PTS	Points	ST	Steals	TO	Turnovers	TOT	Total Rebounds





Place Sidi M'Hamed  
3x3 Basketball  
Men  
Semifinals 9-12  
Match 31



SAT 2 JUL 2022  
Start time 19:00

## Results

Game Duration: 17:39

### ITA 21 vs 18 SLO

Referee: RIBEIRO P. (POR)  
Umpires: Aimeur OUSSAMA (ALG) RIBEIRO P. (POR)

Commissioner: Kosta ILIEV (BUL)

ITA	21
SLO	18

#### ITA - Italy

No.	Name	MIN	PTS	S-EFF	1 Point		2 Points		Free Throws		Rebounds			AS	TO	ST	BS	PF	FD	+/-
					M/A	%	M/A	%	M/A	%	OR	DR	TOT							
*3	GALLO Antonio	6:51	10	0.91	7/8	88	1/2	50	1/1	100	1	1	2					1	2	5
12	VALENTINI Fabio	7:04	2	0.25	2/5	40	0/3	0				2	2					2		1
*16	CHINELLATO Riccardo	8:35	2	0.29	2/5	40	0/2	0			1	3	4						2	3
*33	SERPILLI Michele	8:16	7	0.88	3/4	75	1/2	50	2/2	100		3	3					2	2	1
Team																				
Totals			21	0.62	14/22	64	2/9	22	3/3	100	2	9	11					5	6	

#### SLO - Slovenia

No.	Name	MIN	PTS	S-EFF	1 Point		2 Points		Free Throws		Rebounds			AS	TO	ST	BS	PF	FD	+/-
					M/A	%	M/A	%	M/A	%	OR	DR	TOT							
4	GABERSEK Samo	7:50	4	0.50	2/2	100	1/6	17										1		-2
*6	GRSIC Jan	7:52	5	0.83	1/2	50	2/4	50			1		1					2	1	-2
*9	VIDRIH Rok	7:48	5	0.83	2/3	67	1/2	50	1/1	100	1	1	2					2	1	-2
*32	JANEZIC Blaz	6:37	4	0.80	2/2	100	1/3	33						1				1	2	-3
Team																				
Totals			18	0.72	7/9	78	5/15	33	1/1	100	2	1	3	1				6	4	

	ITA	SLO
Team Fouls	5	6
Teams Fouls at 7		
Teams Fouls at 10		
Technical Fouls		
Unsportsmanlike Fouls		

	ITA	SLO
Biggest lead	3	4
Biggest scoring run	4-0 (6-6)	5-0 (1-5)
Lead changes	5	

#### LEGEND

%	Shooting Percentage	*	Game Starters	+/-	Plus Minus	AS	Assists
BS	Blocked Shots	DR	Defensive Rebounds	EFF	Efficiency	FD	Fouls Drawn
M/A	Made/Attempts	MIN	Minutes Played	OR	Offensive Rebounds	PF	Fouls
PTS	Points	ST	Steals	TO	Turnovers	TOT	Total Rebounds



SAT 2 JUL 2022  
Start time 19:20

## Results

Game Duration: 18:09

### CYP 14 vs 17 EGY

Referee: Kahil YACINE (ALG)  
Umpires: Benani ANIS (ALG) Kahil YACINE (ALG)

Commissioner: Kosta ILIEV (BUL)

CYP 14  
EGY 17

#### CYP - Cyprus

No.	Name	MIN	PTS	S-EFF	1 Point		2 Points		Free Throws		Rebounds			AS	TO	ST	BS	PF	FD	+/-
					M/A	%	M/A	%	M/A	%	OR	DR	TOT							
*4	HIMONAS Andreas	8:18	1	0.17	1/4	25	0/2	0				2	2	2		1		1		1
13	PAPADEMETRIOU Nikolaos	7:48	7	0.70	1/4	25	3/6	50			2	3	5					1	1	-3
*14	TRETIKOV Georgios	8:55	3	1.00	1/1	100	1/2	50			1		1	1				4		-4
*77	CONTANTINOU Marios	6:49	3	0.25	1/1	100	1/11	9				2	2					3		-1
Team																				
Totals			14	0.45	4/10	40	5/21	24			3	7	10	3		1		9	1	

#### EGY - Egypt

No.	Name	MIN	PTS	S-EFF	1 Point		2 Points		Free Throws		Rebounds			AS	TO	ST	BS	PF	FD	+/-
					M/A	%	M/A	%	M/A	%	OR	DR	TOT							
*8	SAIFELDEEN Mustafa	7:15	5	0.45	3/4	75	0/3	0	2/4	50	1	4	5						3	3
*10	OMAR Aly	9:40	8	0.62	1/4	25	2/5	40	3/4	75		5	5		1			1	2	1
35	ELMADAWY Youssef	6:39	1	0.14	0/2	0	0/3	0	1/2	50	2	2	4	1	1				2	5
*55	ELMASHAD Hazem	6:28	3	1.00	3/3	100					5	4	9		3		1		1	-1
Team																				
Totals			17	0.50	7/13	54	2/11	18	6/10	60	8	15	23	1	5		1	1	8	

	CYP	EGY
Team Fouls	9	1
Teams Fouls at 7	7:58	
Teams Fouls at 10		
Technical Fouls	1	
Unsportsmanlike Fouls		

	CYP	EGY
Biggest lead	1	3
Biggest scoring run	4-0 (13-12)	4-0 (4-7)
Lead changes		3

#### LEGEND

%	Shooting Percentage	*	Game Starters	+/-	Plus Minus	AS	Assists
BS	Blocked Shots	DR	Defensive Rebounds	EFF	Efficiency	FD	Fouls Drawn
M/A	Made/Attempts	MIN	Minutes Played	OR	Offensive Rebounds	PF	Fouls
PTS	Points	ST	Steals	TO	Turnovers	TOT	Total Rebounds



Place Sidi M'Hamed  
3x3 Basketball  
Men  
Gold-medal Match  
Match 60



SUN 3 JUL 2022  
Start time 22:30

Results

Game Duration: 21:06

FRA 19 vs 13 SRB

Referee: RIBEIRO P. (POR)  
Umpires: Aimeur OUSSAMA (ALG) RIBEIRO P. (POR)

Commissioner: Kosta ILIEV (BUL)

FRA	19
SRB	13

FRA - France

No.	Name	MIN	PTS	S-EFF	1 Point		2 Points		Free Throws		Rebounds			AS	TO	ST	BS	PF	FD	+/-	
					M/A	%	M/A	%	M/A	%	OR	DR	TOT								
4	GOMIS Marcus Theotim	5:51	2	0.40	2/3	67	0/2	0				4	4					3		8	
*6	DELAUNAY Leopold Olivier	7:48	10	1.25	4/5	80	3/3	100			2	4	6	1	1			3	3	7	
*10	BRUYAS Arthur	7:27	1	0.25	1/3	33	0/1	0			1	1	2		1	1		1	1	-1	
*17	THIROUARD L.	9:19	6	0.60	3/5	60	0/1	0	3/4	75		2	2	2	2	4	1		1	4	4
Team																					
Totals			19	0.70	10/16	63	3/7	43	3/4	75	3	11	14	3	6	2		8	8		

SRB - Serbia

No.	Name	MIN	PTS	S-EFF	1 Point		2 Points		Free Throws		Rebounds			AS	TO	ST	BS	PF	FD	+/-
					M/A	%	M/A	%	M/A	%	OR	DR	TOT							
*8	ANTIC Milos	7:18	3	0.38	3/5	60	0/1	0	0/2	0	1		1	1	1	2		3	4	-1
*9	MOMIROV Stefan	8:03	6	0.50	0/1	0	3/11	27			1		1	1	1			2		-6
10	STANKOVIC Nemanja	6:09	1	0.20			0/3	0	1/2	50	2	2	4		1			2	2	-6
*13	KOVACEVIC Nikola	8:45	3	0.38	2/3	67	0/4	0	1/1	100		3	3	1	2			1	2	-3
Team																				
Totals			13	0.39	5/9	56	3/19	16	2/5	40	4	5	9	3	3	4		8	8	

	FRA	SRB
Team Fouls	8	8
Teams Fouls at 7	7:55	9:12
Teams Fouls at 10		
Technical Fouls		
Unsportsmanlike Fouls		

	FRA	SRB
Biggest lead	6	5
Biggest scoring run	9-0 (13-9)	5-0 (3-8)
Lead changes	1	

LEGEND

%	Shooting Percentage	*	Game Starters	+/-	Plus Minus	AS	Assists
BS	Blocked Shots	DR	Defensive Rebounds	EFF	Efficiency	FD	Fouls Drawn
M/A	Made/Attempts	MIN	Minutes Played	OR	Offensive Rebounds	PF	Fouls
PTS	Points	ST	Steals	TO	Turnovers	TOT	Total Rebounds



Place Sidi M'Hamed  
3x3 Basketball  
Men  
Bronze-medal Match  
Match 58



SUN 3 JUL 2022  
Start time 21:50

Results

Game Duration: 21:40

**TUR 13 vs 16 ESP**  
(13-13; 0-3)

Referee: Najib CHAJIDDINE (FRA)  
Umpires: Kahil YACINE (ALG) Najib CHAJIDDINE (FRA)

Commissioner: Kosta ILIEV (BUL)

OT	
TUR	13
ESP	13
	16

TUR - Turkiye

No.	Name	MIN	PTS	S-EFF	1 Point		2 Points		Free Throws		Rebounds			AS	TO	ST	BS	PF	FD	+/-
					M/A	%	M/A	%	M/A	%	OR	DR	TOT							
*8	AVSAR Ismet Baran	9:37	4	0.31	2/9	22	1/4	25				3	3	1	1	1				-3
*13	BAS Goktuğ	9:18	7	0.78	7/9	78					5	5	10		1			1	3	-1
*23	IVEDI Cengizhan	7:02	2	0.29	2/5	40	0/1	0	0/1	0	2		2		4	1		2	1	2
26	HALAVURTE Mert	5:01	0	0.00	0/1	0	0/1	0				2	2		1				1	-6
Team																				
Totals			13	0.42	11/24	46	1/6	17	0/1	0	7	10	17	1	7	2		3	5	

ESP - Spain

No.	Name	MIN	PTS	S-EFF	1 Point		2 Points		Free Throws		Rebounds			AS	TO	ST	BS	PF	FD	+/-
					M/A	%	M/A	%	M/A	%	OR	DR	TOT							
*3	MENDICOTE RUBIO Unai	9:26	7	0.50	2/7	29	1/4	25	3/3	100		1	1		1			2	2	3
*7	ARCOS GONZALEZ Guillem	7:23	1	0.20	1/3	33	0/2	0			3	3	6		2	1		1		-1
*9	MAYO SCHWANDT Isaac	7:17	7	0.78	4/5	80	1/3	33	1/1	100	1	3	4		1	1		1	1	3
44	GONZALEZ LONGARELA Pablo	6:29	1	0.20	1/3	33	0/2	0			1		1		1	1		1		5
Team																				
Totals			16	0.48	8/18	44	2/11	18	4/4	100	5	7	12		4	4		5	3	

	TUR	ESP
Team Fouls	3	5
Teams Fouls at 7		
Teams Fouls at 10		
Technical Fouls		
Unsportsmanlike Fouls		

	TUR	ESP
Biggest lead	4	3
Biggest scoring run	3-0 (4-1)	5-0 (9-10)
Lead changes		1

LEGEND

%	Shooting Percentage	*	Game Starters	+/-	Plus Minus	AS	Assists
BS	Blocked Shots	DR	Defensive Rebounds	EFF	Efficiency	FD	Fouls Drawn
M/A	Made/Attempts	MIN	Minutes Played	OR	Offensive Rebounds	PF	Fouls
PTS	Points	ST	Steals	TO	Turnovers	TOT	Total Rebounds



Place Sidi M'Hamed  
3x3 Basketball  
Men  
Final 5th-6th Place  
Match 56



SUN 3 JUL 2022  
Start time 21:10

Results

Game Duration: 25:25

POR 17 vs 21 ALG

Referee: Vladimir VESKOVIC (SRB)  
Umpires: Maria Giulia FORNI (ITA) Vladimir VESKOVIC (SRB)

Commissioner: Kosta ILIEV (BUL)

POR 17  
ALG 21

POR - Portugal

No.	Name	MIN	PTS	S-EFF	1 Point		2 Points		Free Throws		Rebounds			AS	TO	ST	BS	PF	FD	+/-
					M/A	%	M/A	%	M/A	%	OR	DR	TOT							
*2	GOMES Andre	9:24	6	0.75	2/4	50	2/4	50			1	3	4		2					-4
*3	AMADU EMBALO Jorge	7:52	2	0.40	0/1	0	1/4	25				3	3	3	3	1		3		-5
*15	COSTA PALHARES Rui Manuel	6:49	5	0.50	3/4	75	0/2	0	2/4	50	1	2	3		1	1		1	2	1
24	DANSO BANORA Lamine	6:28	4	0.57	4/4	100	0/1	0	0/2	0	1		1				1	2	-2	
Team																				
Totals			17	0.57	9/13	69	3/11	27	2/6	33	3	8	11	4	6	2		5	4	

ALG - Algeria

No.	Name	MIN	PTS	S-EFF	1 Point		2 Points		Free Throws		Rebounds			AS	TO	ST	BS	PF	FD	+/-
					M/A	%	M/A	%	M/A	%	OR	DR	TOT							
*5	HIFI Nadir	8:56	13	0.68	5/9	56	3/7	43	2/3	67	3	3	3	1	3	1		1	4	5
*6	MEDJOUBI Bacim	6:56	1	0.25			0/2	0	1/2	50	1	2	3	1					1	1
*7	TALEB Islam-Nizar	6:05	2	0.50	2/3	67	0/1	0			1	4	5		2			3		1
8	BELLIL Mehdi	7:58	5	0.56	1/3	33	1/4	25	2/2	100	1	1	2							6
Team																				
Totals			21	0.58	8/15	53	4/14	29	5/7	71	6	7	13	2	5	1		4	5	

	POR	ALG
Team Fouls	5	4
Teams Fouls at 7		
Teams Fouls at 10		
Technical Fouls		
Unsportsmanlike Fouls		

	POR	ALG
Biggest lead	5	8
Biggest scoring run	6-0 (17-19)	6-0 (9-13)
Lead changes		1

LEGEND

% Shooting Percentage      \* Game Starters      +/- Plus Minus      AS Assists  
 BS Blocked Shots      DR Defensive Rebounds      EFF Efficiency      FD Fouls Drawn  
 M/A Made/Attempts      MIN Minutes Played      OR Offensive Rebounds      PF Fouls  
 PTS Points      ST Steals      TO Turnovers      TOT Total Rebounds



SUN 3 JUL 2022  
Start time 20:50

## Results

Game Duration: 08:54

### GRE 12 vs 21 CRO

Referee: Najib CHAJIDDINE (FRA)  
Umpires: Kahil YACINE (ALG) Najib CHAJIDDINE (FRA)

Commissioner: Kosta ILIEV (BUL)

GRE 12  
CRO 21

#### GRE - Greece

No.	Name	MIN	PTS	S-EFF	1 Point		2 Points		Free Throws		Rebounds			AS	TO	ST	BS	PF	FD	+/-
					M/A	%	M/A	%	M/A	%	OR	DR	TOT							
6	KAPRIS Fotios	1:41	0	0.00	0/1	0						1	1							-2
*13	STAVRAKOUKAS Vasileios	10:00	7	0.78	4/4	100	1/4	25	1/1	100		1	1						1	-9
*14	KALIANIOTIS Georgios	9:10	3	0.50	3/6	50													1	-8
*19	ARNOKOUIROS Georgios	9:13	2	0.67	2/3	67					3		3							-8
Team																				
Totals			12	0.63	9/14	64	1/4	25	1/1	100	3	2	5						2	

#### CRO - Croatia

No.	Name	MIN	PTS	S-EFF	1 Point		2 Points		Free Throws		Rebounds			AS	TO	ST	BS	PF	FD	+/-
					M/A	%	M/A	%	M/A	%	OR	DR	TOT							
*7	RAJIC Mario	10:00	13	1.30	1/3	33	6/7	86			1	1	2					1		9
9	RADOS Luka	0:00																		
*10	NAKIC-VOJNOVIC Ivan	10:00	4	1.33	2/2	100	1/1	100			1	2	3	1						9
*12	VRGOC Ivan	10:00	4	0.50	2/3	67	1/5	20			1	1	2					1		9
Team																				
Totals			21	1.00	5/8	63	8/13	62			3	4	7	1				2		

	GRE	CRO
Team Fouls		2
Teams Fouls at 7		
Teams Fouls at 10		
Technical Fouls		
Unsportsmanlike Fouls		

	GRE	CRO
Biggest lead		9
Biggest scoring run	3-0 (4-5)	4-0 (12-21)
Lead changes		

#### LEGEND

%	Shooting Percentage	*	Game Starters	+/-	Plus Minus	AS	Assists
BS	Blocked Shots	DR	Defensive Rebounds	EFF	Efficiency	FD	Fouls Drawn
M/A	Made/Attempts	MIN	Minutes Played	OR	Offensive Rebounds	PF	Fouls
PTS	Points	ST	Steals	TO	Turnovers	TOT	Total Rebounds



Place Sidi M'Hamed  
3x3 Basketball  
Men  
Final 9th-10th Place  
Match 44



SAT 2 JUL 2022  
Start time 23:20

Results

Game Duration: 20:23

ITA 9 vs 11 EGY

Referee: Kahil YACINE (ALG)  
Umpires: Benani ANIS (ALG) Kahil YACINE (ALG)

Commissioner: Kosta ILIEV (BUL)

ITA	9
EGY	11

ITA - Italy

No.	Name	MIN	PTS	S-EFF	1 Point		2 Points		Free Throws		Rebounds			AS	TO	ST	BS	PF	FD	+/-
					M/A	%	M/A	%	M/A	%	OR	DR	TOT							
*3	GALLO Antonio	7:30	2	0.22	1/2	50	0/2	0	1/5	20	1	1	2		2	1		2	3	1
*12	VALENTINI Fabio	8:30	3	0.33	2/2	100	0/5	0	1/2	50								1	2	-1
*16	CHINELLATO Riccardo	7:49	2	0.29	2/5	40	0/1	0	0/1	0	1	1	2	1				1	1	-4
33	SERPILLI Michele	6:19	2	0.22	1/7	14	0/1	0	1/1	100	1	1	2		1			2	2	-2
Team																				
Totals			9	0.26	6/16	38	0/9	0	3/9	33	3	3	6		3	2		6	8	

EGY - Egypt

No.	Name	MIN	PTS	S-EFF	1 Point		2 Points		Free Throws		Rebounds			AS	TO	ST	BS	PF	FD	+/-
					M/A	%	M/A	%	M/A	%	OR	DR	TOT							
*8	SAIFELDEEN Mustafa	6:23	0	0.00	0/2	0					4	5	9	1	1		1	3	1	3
*10	OMAR Aly	7:51	1	0.13	1/4	25	0/4	0			1	1	1		2				2	1
35	ELMADAWY Youssef	8:03	7	0.50	3/6	50	2/7	29	0/1	0	2	1	3		1			4	3	5
*55	ELMASHAD Hazem	7:50	3	0.50	3/4	75	0/2	0			2	5	7	1	1	1		1		-3
Team																				
Totals			11	0.37	7/16	44	2/13	15	0/1	0	9	11	20	2	5	1	1	8	6	

	ITA	EGY
Team Fouls	6	8
Teams Fouls at 7		7:56
Teams Fouls at 10		
Technical Fouls		
Unsportsmanlike Fouls		

	ITA	EGY
Biggest lead	3	4
Biggest scoring run	3-0 (4-1)	6-0 (5-9)
Lead changes	1	

LEGEND

%	Shooting Percentage	*	Game Starters	+/-	Plus Minus	AS	Assists
BS	Blocked Shots	DR	Defensive Rebounds	EFF	Efficiency	FD	Fouls Drawn
M/A	Made/Attempts	MIN	Minutes Played	OR	Offensive Rebounds	PF	Fouls
PTS	Points	ST	Steals	TO	Turnovers	TOT	Total Rebounds



Place Sidi M'Hamed  
3x3 Basketball  
Men  
Final 11th-12th Pl.  
Match 43



SAT 2 JUL 2022  
Start time: 23:00

Results

Game Duration: 21:09

SLO 16 vs 12 CYP

Referee: RIBEIRO P. (POR)  
Umpires: Maria Giulia FORNI (ITA) RIBEIRO P. (POR)

Commissioner: Kosta ILIEV (BUL)

SLO	16
CYP	12

SLO - Slovenia

No.	Name	MIN	PTS	S-EFF	1 Point		2 Points		Free Throws		Rebounds			AS	TO	ST	BS	PF	FD	+/-
					M/A	%	M/A	%	M/A	%	OR	DR	TOT							
*4	GABERSEK Samo	8:18	3	0.33	3/4	75	0/5	0			1	3	4	1	3			1	1	3
*6	GRSIC Jan	7:46	0	0.00	0/2	0	0/3	0				3	2	5				3		
*9	VIDRIH Rok	7:38	4	0.40	2/3	67	0/3	0	2/4	50	1	4	5		1			2	2	5
32	JANEZIC Blaz	6:40	9	0.56	4/7	57	1/3	33	3/6	50		3	3		1	1		1	6	5
Team																				
Totals			16	0.40	9/16	56	1/14	7	5/10	50	5	12	17	2	5			7	9	

CYP - Cyprus

No.	Name	MIN	PTS	S-EFF	1 Point		2 Points		Free Throws		Rebounds			AS	TO	ST	BS	PF	FD	+/-
					M/A	%	M/A	%	M/A	%	OR	DR	TOT							
*4	HIMONAS Andreas	7:22	3	0.33	0/2	0	1/5	20	1/2	50	3	1	4		2			3	2	-7
13	PAPADEMETRIOU Nikolaos	6:31	1	0.25	1/4	25					2	1	3							-5
*14	TRETIKOV Georgios	7:03	2	0.17	0/4	0	1/6	17	0/2	0	2	5	7					4	2	
*77	CONTANTINOU Marios	8:30	6	0.50	1/1	100	2/9	22	1/2	50	1	1	2		1	1		2	2	-2
Team																				
Totals			12	0.32	2/11	18	4/20	20	2/6	33	8	8	16		3	1		9	6	

	SLO	CYP
Team Fouls	7	9
Teams Fouls at 7	8:17	8:48
Teams Fouls at 10		
Technical Fouls		
Unsportsmanlike Fouls		

	SLO	CYP
Biggest lead	5	
Biggest scoring run	3-0 (4-1)	2-0 (8-5)
Lead changes		1

LEGEND

%	Shooting Percentage	*	Game Starters	+/-	Plus Minus	AS	Assists
BS	Blocked Shots	DR	Defensive Rebounds	EFF	Efficiency	FD	Fouls Drawn
M/A	Made/Attempts	MIN	Minutes Played	OR	Offensive Rebounds	PF	Fouls
PTS	Points	ST	Steals	TO	Turnovers	TOT	Total Rebounds





## Medallists

As of SUN 3 JUL 2022 at 23:49

Gold	Silver	Bronze
<b>ESP - Spain</b> 3 RODRIGUEZ DOMINGUEZ Natalia 6 AYUSO BAGUR Aina 11 GUERRERO ALCANTARA Carolina 13 PUEYO MELCHOR Helena	<b>FRA - France</b> 0 NGO NDJOCK Anna Sara 5 PARDON Marie Helene 6 PEYTOUR-RAISON Emma 7 DROGUET Camille Marie	<b>ITA - Italy</b> 1 DEL PERO Beatrice 14 MADERA Sara 23 BONGIORNO Giulia 28 SMORTO Giovanna Elena



## Pool standings

As of SAT 2 JUL 2022 at 01:01

Group A					Games				Points				
Rank		SRB	POR	ALG	Played	Won	Lost	%Won	For	Against	Diff.	Class.	Avg. P.
1	SRB	---	14 - 11	11 - 7	2	2	0	100	25	18	7	4	12.5
2	POR	11 - 14	---	15 - 13	2	1	1	50	26	27	-1	2	13.0
3	ALG	7 - 11	13 - 15	---	2	0	2	0	20	26	-6	0	10.0

Group B					Games				Points					
Rank		FRA	ITA	TUN	EGY	Played	Won	Lost	%Won	For	Against	Diff.	Class.	Avg. P.
1	FRA	---	13 - 9	21 - 2	16 - 10	3	3	0	100	50	21	29	6	16.7
2	ITA	9 - 13	---	17 - 12	15 - 4	3	2	1	67	41	29	12	4	13.7
3	TUN	2 - 21	12 - 17	---	10 - 8	3	1	2	33	24	46	-22	2	8.0
4	EGY	10 - 16	4 - 15	8 - 10	---	3	0	3	0	22	41	-19	0	7.3

Group C					Games				Points					
Rank		ESP	TUR	SLO	GRE	Played	Won	Lost	%Won	For	Against	Diff.	Class.	Avg. P.
1	ESP	---	18 - 15	16 - 12	21 - 13	3	3	0	100	55	40	15	6	18.3
2	TUR	15 - 18	---	10 - 9	15 - 13	3	2	1	67	40	40	0	4	13.3
3	SLO	12 - 16	9 - 10	---	15 - 11	3	1	2	33	36	37	-1	2	12.0
4	GRE	13 - 21	13 - 15	11 - 15	---	3	0	3	0	37	51	-14	0	12.3

## Games Schedule

Date	Start time	Phase	Game	Teams	Result
THU 30 JUN	18:00	Preliminary Group B	1	FRA - TUN	21 - 2
THU 30 JUN	18:20	Preliminary Group B	2	EGY - ITA	4 - 15
THU 30 JUN	19:20	Preliminary Group C	5	ESP - TUR	18 - 15
THU 30 JUN	19:40	Preliminary Group C	6	GRE - SLO	11 - 15
THU 30 JUN	20:40	Preliminary Group A	9	ALG - SRB	7 - 11
THU 30 JUN	21:20	Preliminary Group B	11	TUN - ITA	12 - 17
THU 30 JUN	21:40	Preliminary Group B	12	FRA - EGY	16 - 10
THU 30 JUN	22:40	Preliminary Group C	15	TUR - SLO	10 - 9
THU 30 JUN	23:00	Preliminary Group C	16	ESP - GRE	21 - 13
FRI 1 JUL	19:40	Preliminary Group A	19	POR - ALG	15 - 13
FRI 1 JUL	20:00	Preliminary Group B	20	TUN - EGY	10 - 8
FRI 1 JUL	20:20	Preliminary Group B	21	ITA - FRA	9 - 13
FRI 1 JUL	21:40	Preliminary Group C	25	TUR - GRE	15 - 13
FRI 1 JUL	22:00	Preliminary Group C	26	SLO - ESP	12 - 16
FRI 1 JUL	23:00	Preliminary Group A	29	SRB - POR	14 - 11



## Brackets

As of MON 4 JUL 2022 at 00:19

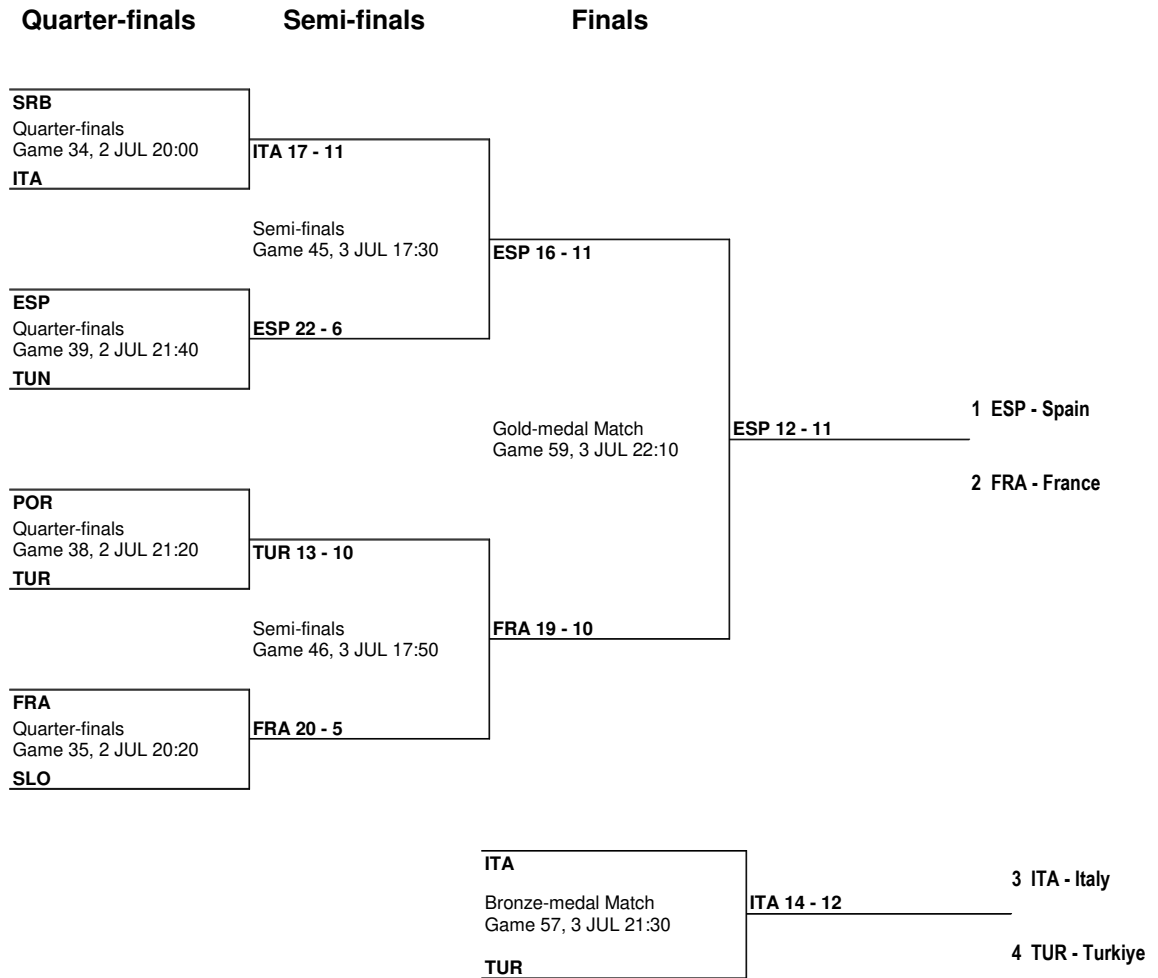



## Team Roster

As of WED 29 JUN 2022 at 21:14

### ALG - Algeria

No.	Name	Pos	Height	Date of Birth	Age	Club	Int. Matches
5	GRIBI Iness Fatima Zora		1.71 / 5 ' 7 "	27 FEB 2003	19		
10	KETFI Kaouther		1.75 / 5 ' 9 "	23 MAY 2001	21		
11	ALLIK Cerine		1.70 / 5 ' 7 "	26 NOV 2000	22		
13	BELABBAS Loubna		1.75 / 5 ' 9 "	2 APR 2002	20		
Team averages			1.73 / 5 ' 8 "		20.5		

#### Team Uniform Color

Light White

Dark Green

#### LEGEND

G Guard      No. Uniform Number      Pos Playing position      F Forward



## Team Roster

As of WED 29 JUN 2022 at 21:14

EGY - Egypt

No.	Name	Pos	Height	Date of Birth	Age	Club	Int. Matches
8	KABIL Fatma		1.79 / 5' 10"	5 MAR 2002	20		
10	BADAWY Ingy		1.67 / 5' 6"	8 JUL 2001	20		
12	OWEIS Radwa		1.72 / 5' 8"	14 NOV 1999	23		
44	HUSSEIN Yara		1.85 / 6' 1"	4 APR 2002	20		
Team averages			1.76 / 5' 9"		20.8		

### Team Uniform Color

Light White

Dark Red

### LEGEND

G	Guard	No.	Uniform Number	Pos	Playing position	F	Forward
---	-------	-----	----------------	-----	------------------	---	---------



## Team Roster

As of WED 29 JUN 2022 at 21:14

### ESP - Spain

No.	Name	Pos	Height	Date of Birth	Age	Club	Int. Matches
3	RODRIGUEZ DOMINGUEZ Natalia	G (1)	1.82 / 6 ' 0 "	26 JAN 1999	23	BAXI FERROL, FERROL (ESP)	
6	AYUSO BAGUR Aina	G (2)	1.75 / 5 ' 9 "	1 AUG 1999	22	CB PROMETE, LOGROÑO (ESP)	
11	GUERRERO ALCANTARA Carolina	G (1)	1.87 / 6 ' 2 "	1 SEP 2000	21	BARÇA CBS, SANT FELIU LLOBREGAT (ESP)	
13	PUEYO MELCHOR Helena	F (3)	1.82 / 6 ' 0 "	13 FEB 2001	21	ARIZONA WOMEN'S BASKETBALL, ARIZON	
<b>Team averages</b>			1.82 / 6 ' 0 "		21.8		

#### Team Uniform Color

Light White

Dark Red

#### LEGEND

G Guard      No. Uniform Number      Pos Playing position      F Forward



## Team Roster

As of WED 29 JUN 2022 at 21:14

FRA - France

No.	Name	Pos	Height	Date of Birth	Age	Club	Int. Matches
0	NGO NDJOCK Anna Sara	F (3/4)		14 JAN 1999	23	BC La Tronche Meylan, La Tronche Meylan (F)	
5	PARDON Marie Helene	G (1/2)		5 JAN 2001	21	Tarbes Gespe Bigorre, Tarbes (FRA)	
6	PEYTOUR-RAISON Emma			11 AUG 2000	21		
7	DROGUET Camille Marie	F (3/4)		15 JUN 1999	23	Kibirkstis Vilnius, Vilnius (LTU)	
<b>Team averages</b>					22.0		

### Team Uniform Color

Light White

Dark Blue

### LEGEND

G Guard      No. Uniform Number      Pos Playing position      F Forward



## Team Roster

As of WED 29 JUN 2022 at 21:14

### GRE - Greece

No.	Name	Pos	Height	Date of Birth	Age	Club	Int. Matches
4	CHATZIVASILEIOU Ioanna	G (1/2)	1.77 / 5' 10"	11 APR 2000	22	PROTEAS VOULAS, VOULA (GRE)	
5	STOUPA Nefeli Spyridoula	F (3/4)	1.83 / 6' 0"	21 FEB 1999	23	AGIA PARASKEVI, AGIA PARASKEVI (GRE)	
11	KORRE Zoi	G (1/2)	1.76 / 5' 9"	14 JUL 2000	22	ILIOUPOLI, ILIOUPOLI (GRE)	
13	ANASTASOPOULOU Maria Konstantina	C (5)	1.88 / 6' 2"	12 JUL 1999	22	PROTEAS VOULAS, VOULA (GRE)	
<b>Team averages</b>			1.81 / 5' 11"		22.3		

#### Team Uniform Color

Light White

Dark Blue

#### LEGEND

G Guard      No. Uniform Number      Pos Playing position      F Forward





## Team Roster

As of WED 29 JUN 2022 at 21:14

### ITA - Italy

No.	Name	Pos	Height	Date of Birth	Age	Club	Int. Matches
1	DEL PERO Beatrice	G (2)		17 APR 1999	23	FAMILA SCHIO, SCHIO (ITA)	
14	MADERA Sara	C (5)		28 JUN 2000	22	REYER VENEZIA, MESTRE (ITA)	
23	BONGIORNO Giulia	G (1/2)		17 JUN 2000	22	BASKET ROMA, ROMA (ITA)	
28	SMORTO Giovanna Elena	G (1/2)		28 APR 1999	23	REYER VENEZIA, MESTRE (ITA)	
<b>Team averages</b>					22.5		

#### Team Uniform Color

Light White

Dark Blue

#### LEGEND

G Guard      No. Uniform Number      Pos Playing position      F Forward



## Team Roster

As of WED 29 JUN 2022 at 21:14

### POR - Portugal

No.	Name	Pos	Height	Date of Birth	Age	Club	Int. Matches
5	DE LIMA VIEGAS Raquel		1.70 / 5' 7"	10 NOV 2000	21		
6	MOTA MARTINS Alice		1.83 / 6' 0"	9 FEB 2000	22		
11	BARATA SILVA Mariana		1.84 / 6' 0"	18 MAY 1999	23		
23	MAIO MARINHO Maria		1.80 / 5' 11"	18 OCT 2000	22		
Team averages			1.79 / 5' 10"		22.0		

#### Team Uniform Color

Light White

Dark Red

#### LEGEND

G Guard      No. Uniform Number      Pos Playing position      F Forward



## Team Roster

As of WED 29 JUN 2022 at 21:14

### SLO - Slovenia

No.	Name	Pos	Height	Date of Birth	Age	Club	Int. Matches
3	SEVER Katja		1.77 / 5' 10"	13 MAR 2003	19		
5	JERAS Ana Dora		1.87 / 6' 2"	28 FEB 2000	22		
9	BURGAR Ajda		1.76 / 5' 9"	9 AUG 2001	20		
21	BERUS Spela		1.78 / 5' 10"	17 NOV 2003	19		
Team averages			1.80 / 5' 11"		20.0		

#### Team Uniform Color

Light White

Dark Blue

#### LEGEND

G Guard      No. Uniform Number      Pos Playing position      F Forward



## Team Roster

As of WED 29 JUN 2022 at 21:14

### SRB - Serbia

No.	Name	Pos	Height	Date of Birth	Age	Club	Int. Matches
3	RADULOVIC Lena		1.93 / 6 ' 4 "	3 JAN 2000	22		
9	CURAKOVIC Ivana		1.91 / 6 ' 3 "	20 JUN 2000	22		
22	JELIC Tijana		1.82 / 6 ' 0 "	27 FEB 1999	23		
25	TESIC Nina		1.89 / 6 ' 2 "	3 MAY 1999	23		
Team averages			1.89 / 6 ' 2 "		22.5		

#### Team Uniform Color

Light White

Dark Blue

#### LEGEND

G Guard      No. Uniform Number      Pos Playing position      F Forward



## Team Roster

As of WED 29 JUN 2022 at 21:14

### TUN - Tunisia

No.	Name	Pos	Height	Date of Birth	Age	Club	Int. Matches
6	BEN RHOUMA Hibet Allah		1.63 / 5 ' 4 "	11 APR 2002	20		
13	BEN GARA Sirine		1.83 / 6 ' 0 "	9 APR 1999	23		
24	SHILI Marwa		1.70 / 5 ' 7 "	14 DEC 1999	23		
31	JDIDI BAGANE Abir		1.83 / 6 ' 0 "	28 MAR 2001	21		
Team averages			1.75 / 5 ' 9 "		21.8		

#### Team Uniform Color

Light White

Dark Red

#### LEGEND

G	Guard	No.	Uniform Number	Pos	Playing position	F	Forward
---	-------	-----	----------------	-----	------------------	---	---------



## Team Roster

As of WED 29 JUN 2022 at 21:14

### TUR - Turkiye

No.	Name	Pos	Height	Date of Birth	Age	Club	Int. Matches
1	AKALAN Feride Seval			14 OCT 2001	21		
5	ADICAN Doga			15 FEB 2001	21		
9	USTUN Deniz			23 OCT 1999	23		
21	CENGIZHAN Aleyna Fatma			28 FEB 2002	20		
Team averages					21.3		

#### Team Uniform Color

Light	White
Dark	Red

#### LEGEND

G	Guard	No.	Uniform Number	Pos	Playing position	F	Forward
---	-------	-----	----------------	-----	------------------	---	---------



Place Sidi M'Hamed  
3x3 Basketball  
Women  
Preliminary - Group A  
Match 9



THU 30 JUN 2022  
Start time 20:40

Results

Game Duration: 19:38

ALG 7 vs 11 SRB

Referee: Maria Giulia FORNI (ITA)  
Umpires: RIBEIRO P. (POR) Maria Giulia FORNI (ITA)

Commissioner: Kosta ILIEV (BUL)

ALG	7
SRB	11

ALG - Algeria

No.	Name	MIN	PTS	S-EFF	1 Point		2 Points		Free Throws		Rebounds			AS	TO	ST	BS	PF	FD	+/-
					M/A	%	M/A	%	M/A	%	OR	DR	TOT							
5	GRIBI Iness Fatima Zora	10:00	3	0.25	2/7	29	0/4	0	1/1	100			1					5	1	-4
10	KETFI Kaouther	8:00									1		1							-3
11	ALLIK Cerine	6:57	1	0.33	1/1	100	0/2	0				1	1					1		-4
13	BELABBAS Loubna	7:06	3	0.27	3/6	50	0/4	0	0/1	0		1	1					3	1	-3
Team																				
Totals			7	0.27	6/14	43	0/10	0	1/2	50	1	2	3	1				9	2	

SRB - Serbia

No.	Name	MIN	PTS	S-EFF	1 Point		2 Points		Free Throws		Rebounds			AS	TO	ST	BS	PF	FD	+/-
					M/A	%	M/A	%	M/A	%	OR	DR	TOT							
3	RADULOVIC Lena	9:21	3	0.38	3/4	75	0/3	0	0/1	0		1	1	2					1	5
9	CURAKOVIC Ivana	8:08	0	0.00					0/1	0	1		1						2	4
22	JELIC Tijana	8:38	7	0.70	4/6	67	1/2	50	1/2	50	1	1	2					1	4	3
25	TESIC Nina	7:34	1	0.13	1/3	33	0/3	0	0/2	0	2		2					1	2	4
Team																				
Totals			11	0.41	8/13	62	1/8	13	1/6	17	4	2	6	2				2	9	

	ALG	SRB
Team Fouls	9	2
Teams Fouls at 7	6:39	
Teams Fouls at 10		
Technical Fouls		
Unsportsmanlike Fouls		

	ALG	SRB
Biggest lead	2	5
Biggest scoring run	2-0 (2-0)	7-0 (5-10)
Lead changes		

LEGEND

%	Shooting Percentage	*	Game Starters	+/-	Plus Minus	AS	Assists
BS	Blocked Shots	DR	Defensive Rebounds	EFF	Efficiency	FD	Fouls Drawn
M/A	Made/Attempts	MIN	Minutes Played	OR	Offensive Rebounds	PF	Fouls
PTS	Points	ST	Steals	TO	Turnovers	TOT	Total Rebounds



Place Sidi M'Hamed  
3x3 Basketball  
Women  
Preliminary - Group A  
Match 19



FRI 1 JUL 2022  
Start time 19:40

Results

Game Duration: 22:04

POR 15 vs 13 ALG

Referee: Najib CHAJIDDINE (FRA)  
Umpires: Maria Giulia FORNI (ITA) Najib CHAJIDDINE (FRA)

Commissioner: Kosta ILIEV (BUL)

POR 15  
ALG 13

POR - Portugal

No.	Name	MIN	PTS	S-EFF	1 Point		2 Points		Free Throws		Rebounds			AS	TO	ST	BS	PF	FD	+/-
					M/A	%	M/A	%	M/A	%	OR	DR	TOT							
*5	DE LIMA VIEGAS Raquel	7:59	9	0.60	3/6	50	2/7	29	2/2	100		3	3	2				1	1	4
*6	MOTA MARTINS Alice	6:57	0	0.00	0/2	0					2	1	3					1	1	1
*11	BARATA SILVA Mariana	7:21	4	0.40	4/7	57	0/2	0	0/1	0		2	2	1					3	1
23	MAIO MARINHO Maria	7:47	2	0.40	1/4	25			1/1	100		1	1					4	2	
Team																				
Totals			15	0.47	8/19	42	2/9	22	3/4	75	2	7	9	3				6	7	

ALG - Algeria

No.	Name	MIN	PTS	S-EFF	1 Point		2 Points		Free Throws		Rebounds			AS	TO	ST	BS	PF	FD	+/-
					M/A	%	M/A	%	M/A	%	OR	DR	TOT							
*5	GRIBI Iness Fatima Zora	8:52	2	0.22	0/3	0	1/6	17			1	1	2					1	2	-5
*10	KETFI Kaouther	5:52	1	0.25	1/2	50	0/2	0				1	1					1		-2
11	ALLIK Cerine	6:46	0	0.00			0/4	0			1		1					2		1
*13	BELABBAS Loubna	8:39	10	0.63	5/7	71	1/5	20	3/4	75		2	2					3	4	
Team																				
Totals			13	0.39	6/12	50	2/17	12	3/4	75	2	4	6					7	6	

	POR	ALG
Team Fouls	6	7
Teams Fouls at 7		6:22
Teams Fouls at 10		
Technical Fouls		
Unsportsmanlike Fouls		

	POR	ALG
Biggest lead	8	
Biggest scoring run	6-0 (13-5)	3-0 (13-8)
Lead changes		

LEGEND

% Shooting Percentage      \* Game Starters      +/- Plus Minus      AS Assists  
 BS Blocked Shots      DR Defensive Rebounds      EFF Efficiency      FD Fouls Drawn  
 M/A Made/Attempts      MIN Minutes Played      OR Offensive Rebounds      PF Fouls  
 PTS Points      ST Steals      TO Turnovers      TOT Total Rebounds





FRI 1 JUL 2022  
Start time: 23:00

## Results

Game Duration: 20:58

### SRB 14 vs 11 POR

Referee: Aimeur OUSSAMA (ALG)  
Umpires: Maria Giulia FORNI (ITA) Aimeur OUSSAMA (ALG)

Commissioner: Kosta ILIEV (BUL)

SRB	14
POR	11

#### SRB - Serbia

No.	Name	MIN	PTS	S-EFF	1 Point		2 Points		Free Throws		Rebounds			AS	TO	ST	BS	PF	FD	+/-
					M/A	%	M/A	%	M/A	%	OR	DR	TOT							
*3	RADULOVIC Lena	7:18	6	0.46	3/9	33			3/4	75	1	1	2	3	1			2	4	4
*9	CURAKOVIC Ivana	8:15	0	0.00	0/1	0						5	5		1				1	
*22	JELIC Tijana	8:36	5	0.31	4/9	44	0/5	0	1/2	50	1	5	6		1			1	2	2
25	TESIC Nina	6:03	3	0.50	3/5	60			0/1	0	2		2			1		2	1	3
Team																				
Totals			14	0.39	10/24	42	0/5	0	4/7	57	4	11	15	3	3	1		5	8	

#### POR - Portugal

No.	Name	MIN	PTS	S-EFF	1 Point		2 Points		Free Throws		Rebounds			AS	TO	ST	BS	PF	FD	+/-
					M/A	%	M/A	%	M/A	%	OR	DR	TOT							
*5	DE LIMA VIEGAS Raquel	7:03	4	0.57	0/2	0	2/5	40				3	3	2						
6	MOTA MARTINS Alice	5:44	3	0.43	3/7	43						2	2					2	2	-4
*11	BARATA SILVA Mariana	9:05	3	0.43	3/7	43					1	3	4		1	1		4	2	
*23	MAIO MARINHO Maria	8:21	1	0.20	1/3	33	0/1	0	0/1	0	1	1	2		2			2	1	-5
Team																				
Totals			11	0.42	7/19	37	2/6	33	0/1	0	2	9	11	2	3	1		8	5	

	SRB	POR
Team Fouls	5	8
Teams Fouls at 7		4:44
Teams Fouls at 10		
Technical Fouls		
Unsportsmanlike Fouls		

	SRB	POR
Biggest lead	6	
Biggest scoring run	4-0 (7-3)	3-0 (13-11)
Lead changes		3

#### LEGEND

%	Shooting Percentage	*	Game Starters	+/-	Plus Minus	AS	Assists
BS	Blocked Shots	DR	Defensive Rebounds	EFF	Efficiency	FD	Fouls Drawn
M/A	Made/Attempts	MIN	Minutes Played	OR	Offensive Rebounds	PF	Fouls
PTS	Points	ST	Steals	TO	Turnovers	TOT	Total Rebounds



THU 30 JUN 2022  
Start time 18:00

## Results

Game Duration: 13:16

### FRA 21 vs 2 TUN

Referee: Maria Giulia FORNI (ITA)  
Umpires: AIMEUR OUSSAMA (ALG) Maria Giulia FORNI (ITA)

Commissioner: Kosta ILIEV (BUL)

FRA	21
TUN	2

#### FRA - France

No.	Name	MIN	PTS	S-EFF	1 Point		2 Points		Free Throws		Rebounds			AS	TO	ST	BS	PF	FD	+/-
					M/A	%	M/A	%	M/A	%	OR	DR	TOT							
*0	NGO NDJOCK Anna Sara	6:06	2	0.29	0/1	0	1/6	17			1		1					1		11
*5	PARDON Marie Helene	6:59	3	0.60	1/1	100	1/4	25					1	1						17
6	PEYTOUR-RAISON Emma	3:59	8	1.00	0/2	0	4/6	67			1		1						2	16
*7	DROGUET Camille Marie	7:16	8	0.80	5/6	83	1/3	33	1/1	100	1	1	2	1					1	17
Team																				
Totals			21	0.70	6/10	60	7/19	37	1/1	100	3	1	4	2	1			1	3	

#### TUN - Tunisia

No.	Name	MIN	PTS	S-EFF	1 Point		2 Points		Free Throws		Rebounds			AS	TO	ST	BS	PF	FD	+/-
					M/A	%	M/A	%	M/A	%	OR	DR	TOT							
*6	BEN RHOUMA Hibet Allah	7:33	0	0.00			0/1	0					1		1				1	-17
13	BEN GARA Sirine	3:40	1	0.33	1/2	50	0/1	0				1	1							-11
*24	SHILI Marwa	4:50	0	0.00	0/1	0	0/2	0						1				2		-12
*31	JDIDI BAGANE Abir	7:30	1	0.20	1/3	33	0/2	0				1	1		1			1		-17
Team																				
Totals			2	0.17	2/6	33	0/6	0				2	2	1	2	1		3	1	

	FRA	TUN
Team Fouls	1	3
Teams Fouls at 7		
Teams Fouls at 10		
Technical Fouls		
Unsportsmanlike Fouls		

	FRA	TUN
Biggest lead	19	
Biggest scoring run	11-0 (21-2)	1-0 (2-1)
Lead changes		

#### LEGEND

%	Shooting Percentage	*	Game Starters	+/-	Plus Minus	AS	Assists
BS	Blocked Shots	DR	Defensive Rebounds	EFF	Efficiency	FD	Fouls Drawn
M/A	Made/Attempts	MIN	Minutes Played	OR	Offensive Rebounds	PF	Fouls
PTS	Points	ST	Steals	TO	Turnovers	TOT	Total Rebounds



Place Sidi M'Hamed  
3x3 Basketball  
Women  
Preliminary - Group B  
Match 2



THU 30 JUN 2022  
Start time 18:20

Results

Game Duration: 15:45

EGY 4 vs 15 ITA

Referee: RIBEIRO P. (POR)  
Umpires: Kahil YACINE (ALG) RIBEIRO P. (POR)

Commissioner: Kosta ILIEV (BUL)

EGY	4
ITA	15

EGY - Egypt

No.	Name	MIN	PTS	S-EFF	1 Point		2 Points		Free Throws		Rebounds			AS	TO	ST	BS	PF	FD	+/-
					M/A	%	M/A	%	M/A	%	OR	DR	TOT							
*8	KABIL Fatma	7:24	0	0.00	0/5	0	0/3	0										2		-9
10	BADAWY Inqv	8:14	3	0.43	3/5	60	0/1	0	0/1	0								1	1	-9
*12	OWEIS Radwa	7:44	1	0.14	1/4	25	0/2	0	0/1	0									1	-7
*44	HUSSEIN Yara	7:11									1	1	2							-8
Team																				
Totals			4	0.18	4/14	29	0/6	0	0/2	0	1	2	3					3	2	

ITA - Italy

No.	Name	MIN	PTS	S-EFF	1 Point		2 Points		Free Throws		Rebounds			AS	TO	ST	BS	PF	FD	+/-
					M/A	%	M/A	%	M/A	%	OR	DR	TOT							
*1	DEL PERO Beatrice	8:44	4	0.50	2/4	50	1/4	25			1	1	2	3						11
*14	MADERA Sara	6:42	6	0.50	4/8	50	1/2	50	0/2	0		1	1						2	6
23	BONGIORNO Giulia	8:27	2	0.33	0/3	0	1/3	33			2		2					1		8
*28	SMORTO Giovanna Elena	6:32	3	0.60	3/4	75	0/1	0				1	1					2		11
Team																				
Totals			15	0.48	9/19	47	3/10	30	0/2	0	3	3	6	3				3	2	

	EGY	ITA
Team Fouls	3	3
Teams Fouls at 7		
Teams Fouls at 10		
Technical Fouls		
Unsportsmanlike Fouls		

	EGY	ITA
Biggest lead		12
Biggest scoring run	1-0 (1-2)	9-0 (1-11)
Lead changes		

LEGEND

%	Shooting Percentage	*	Game Starters	+/-	Plus Minus	AS	Assists
BS	Blocked Shots	DR	Defensive Rebounds	EFF	Efficiency	FD	Fouls Drawn
M/A	Made/Attempts	MIN	Minutes Played	OR	Offensive Rebounds	PF	Fouls
PTS	Points	ST	Steals	TO	Turnovers	TOT	Total Rebounds



Place Sidi M'Hamed  
3x3 Basketball  
Women  
Preliminary - Group B  
Match 11



THU 30 JUN 2022  
Start time 21:20

Results

Game Duration: 17:09

TUN 12 vs 17 ITA

Referee: Aimeur OUSSAMA (ALG)  
Umpires: Vladimir VESKOVIC (SRB) Aimeur OUSSAMA (ALG)

Commissioner: Kosta ILIEV (BUL)

TUN 12  
ITA 17

TUN - Tunisia

No.	Name	MIN	PTS	S-EFF	1 Point		2 Points		Free Throws		Rebounds			AS	TO	ST	BS	PF	FD	+/-
					M/A	%	M/A	%	M/A	%	OR	DR	TOT							
*6	BEN RHOUMA Hibet Allah	8:20	2	0.29	2/5	40	0/2	0										1		-5
*13	BEN GARA Sirine	8:41	1	0.50	1/2	50					1	2	3							-5
*24	SHILI Marwa	9:20	5	0.42	2/5	40	1/6	17	1/1	100	1	1	2							-1
31	JDIDI BAGANE Abir	4:28	4	0.67	3/5	60			1/1	100								2	1	-6
Team																				
Totals			12	0.44	8/17	47	1/8	13	2/2	100	2	3	5					3	1	

ITA - Italy

No.	Name	MIN	PTS	S-EFF	1 Point		2 Points		Free Throws		Rebounds			AS	TO	ST	BS	PF	FD	+/-
					M/A	%	M/A	%	M/A	%	OR	DR	TOT							
*1	DEL PERO Beatrice	8:45	5	0.42	0/4	0	2/7	29	1/1	100	1		1					1		6
*14	MADERA Sara	6:48	6	0.67	2/3	67	1/4	25	2/2	100	1		1					3		6
23	BONGIORNO Giulia	7:09	5	0.45	3/5	60	1/6	17				2	2							4
*28	SMORTO Giovanna Elena	8:17	1	0.50	1/2	50														3
Team																				
Totals			17	0.50	6/14	43	4/17	24	3/3	100	2	2	4					1	3	

	TUN	ITA
Team Fouls	3	1
Teams Fouls at 7		
Teams Fouls at 10		
Technical Fouls		
Unsportsmanlike Fouls		

	TUN	ITA
Biggest lead	1	8
Biggest scoring run	3-0 (10-15)	6-0 (3-9)
Lead changes		1

LEGEND

% Shooting Percentage      \* Game Starters      +/- Plus Minus      AS Assists  
 BS Blocked Shots      DR Defensive Rebounds      EFF Efficiency      FD Fouls Drawn  
 M/A Made/Attempts      MIN Minutes Played      OR Offensive Rebounds      PF Fouls  
 PTS Points      ST Steals      TO Turnovers      TOT Total Rebounds



Place Sidi M'Hamed  
3x3 Basketball  
Women  
Preliminary - Group B  
Match 12



THU 30 JUN 2022  
Start time 21:40

Results

Game Duration: 19:57

FRA 16 vs 10 EGY

Referee: RIBEIRO P. (POR)  
Umpires: Aimeur OUSSAMA (ALG) RIBEIRO P. (POR)

Commissioner: Kosta ILIEV (BUL)

FRA	16
EGY	10

FRA - France

No.	Name	MIN	PTS	S-EFF	1 Point		2 Points		Free Throws		Rebounds			AS	TO	ST	BS	PF	FD	+/-
					M/A	%	M/A	%	M/A	%	OR	DR	TOT							
*0	NGO NDJOCK Anna Sara	8:04	5	0.83	2/2	100	1/3	33	1/1	100	1	1	2	1				2	2	6
*5	PARDON Marie Helene	7:26	4	0.57	2/4	50	1/3	33						1						5
6	PEYTOUR-RAISON Emma	7:16	3	0.27	1/5	20	1/6	17			2		2					1		3
*7	DROGUET Camille Marie	7:07	4	0.80	3/3	100	0/1	0	1/1	100		1	1					3	1	4
Team																				
Totals			16	0.55	8/14	57	3/13	23	2/2	100	3	2	5	2				6	3	

EGY - Egypt

No.	Name	MIN	PTS	S-EFF	1 Point		2 Points		Free Throws		Rebounds			AS	TO	ST	BS	PF	FD	+/-
					M/A	%	M/A	%	M/A	%	OR	DR	TOT							
*8	KABIL Fatma	7:08	2	0.25	2/7	29			0/1	0	1	1	2	1				1	2	-6
10	BADAWY Ingy	6:44	2	0.40	1/2	50	0/2	0	1/1	100		1	1	2					2	-2
*12	OWEIS Radwa	8:16	3	0.33	3/6	50	0/2	0	0/1	0	2	2	4					1	1	-7
*44	HUSSEIN Yara	7:48	3	0.75	2/3	67			1/1	100		1	1					1	1	-3
Team																				
Totals			10	0.38	8/18	44	0/4	0	2/4	50	3	5	8	3				3	6	

	FRA	EGY
Team Fouls	6	3
Teams Fouls at 7		
Teams Fouls at 10		
Technical Fouls		
Unsportsmanlike Fouls		

	FRA	EGY
Biggest lead	8	
Biggest scoring run	7-0 (16-8)	4-0 (9-8)
Lead changes		

LEGEND

%	Shooting Percentage	*	Game Starters	+/-	Plus Minus	AS	Assists
BS	Blocked Shots	DR	Defensive Rebounds	EFF	Efficiency	FD	Fouls Drawn
M/A	Made/Attempts	MIN	Minutes Played	OR	Offensive Rebounds	PF	Fouls
PTS	Points	ST	Steals	TO	Turnovers	TOT	Total Rebounds



Place Sidi M'Hamed  
3x3 Basketball  
Women  
Preliminary - Group B  
Match 20



FRI 1 JUL 2022  
Start time 20:00

## Results

Game Duration: 19:08

### TUN 10 vs 8 EGY

Referee: Kahil YACINE (ALG)  
Umpires: Benani ANIS (ALG) Kahil YACINE (ALG)

Commissioner: Kosta ILIEV (BUL)

TUN	10
EGY	8

#### TUN - Tunisia

No.	Name	MIN	PTS	S-EFF	1 Point		2 Points		Free Throws		Rebounds			AS	TO	ST	BS	PF	FD	+/-
					M/A	%	M/A	%	M/A	%	OR	DR	TOT							
*6	BEN RHOUMA Hibet Allah	9:05	3	0.33	3/5	60	0/2	0	0/2	0			1					1	5	2
13	BEN GARA Sirine	7:13	2	0.50	2/4	50					1		1					1		
*24	SHILI Marwa	8:29	4	0.57	2/4	50	1/3	33					2						1	4
31	JDIDI BAGANE Abir	5:01	1	0.25	1/2	50	0/2	0				2	2					3		
Team																				
Totals			10	0.42	8/15	53	1/7	14	0/2	0	1	2	3	3				5	6	

#### EGY - Egypt

No.	Name	MIN	PTS	S-EFF	1 Point		2 Points		Free Throws		Rebounds			AS	TO	ST	BS	PF	FD	+/-
					M/A	%	M/A	%	M/A	%	OR	DR	TOT							
*8	KABIL Fatma	8:07	2	0.18	2/7	29	0/3	0	0/1	0		1	1					1	1	-2
*10	BADAWY Ingy	7:24	0	0.00	0/2	0	0/2	0	0/1	0		1	1	1				2	1	-2
*12	OWEIS Radwa	7:37	3	0.43	3/4	75	0/3	0			2		2					2	1	-1
44	HUSSEIN Yara	6:40	3	0.43	1/4	25	0/1	0	2/2	100	1	4	5					1	2	-2
Team																				
Totals			8	0.27	6/17	35	0/9	0	2/4	50	3	6	9	1				6	5	

	TUN	EGY
Team Fouls	5	6
Teams Fouls at 7		
Teams Fouls at 10		
Technical Fouls		
Unsportsmanlike Fouls		

	TUN	EGY
Biggest lead	4	
Biggest scoring run	3-0 (8-4)	2-0 (3-3)
Lead changes		1

#### LEGEND

%	Shooting Percentage	*	Game Starters	+/-	Plus Minus	AS	Assists
BS	Blocked Shots	DR	Defensive Rebounds	EFF	Efficiency	FD	Fouls Drawn
M/A	Made/Attempts	MIN	Minutes Played	OR	Offensive Rebounds	PF	Fouls
PTS	Points	ST	Steals	TO	Turnovers	TOT	Total Rebounds



Place Sidi M'Hamed  
3x3 Basketball  
Women  
Preliminary - Group B  
Match 21



FRI 1 JUL 2022  
Start time 20:20

Results

Game Duration: 17:02

ITA 9 vs 13 FRA

Referee: RIBEIRO P. (POR)  
Umpires: Aimeur OUSSAMA (ALG) RIBEIRO P. (POR)

Commissioner: Kosta ILIEV (BUL)

ITA	9
FRA	13

ITA - Italy

No.	Name	MIN	PTS	S-EFF	1 Point		2 Points		Free Throws		Rebounds			AS	TO	ST	BS	PF	FD	+/-
					M/A	%	M/A	%	M/A	%	OR	DR	TOT							
*1	DEL PERO Beatrice	6:06	3	0.60	1/3	33	1/2	50										2		-5
*14	MADERA Sara	7:50	5	0.42	3/10	30	1/2	50				3	3						3	1
23	BONGIORNO Giulia	7:21	0	0.00	0/4	0	0/1	0				1	1					3	1	-4
*28	SMORTO Giovanna Elena	8:21	1	0.25	1/4	25						2	2	1				2		-3
Team																				
Totals			9	0.35	5/21	24	2/5	40				6	6	1				7	4	

FRA - France

No.	Name	MIN	PTS	S-EFF	1 Point		2 Points		Free Throws		Rebounds			AS	TO	ST	BS	PF	FD	+/-
					M/A	%	M/A	%	M/A	%	OR	DR	TOT							
*0	NGO NDJOCK Anna Sara	7:03	5	0.63	3/4	75	1/4	25				1	1					1		6
*5	PARDON Marie Helene	6:50	0	0.00	0/2	0	0/1	0	0/2	0		1	1					1	1	2
6	PEYTOUR-RAISON Emma	7:57	5	0.38	2/5	40	1/6	17	1/2	50		1	1	1				1	2	5
*7	DROGUET Camille Marie	7:51	3	0.50	1/3	33			2/3	67	1	2	3					1	4	1
Team																				
Totals			13	0.41	6/14	43	2/11	18	3/7	43	1	5	6	1				4	7	

	ITA	FRA
Team Fouls	7	4
Teams Fouls at 7	9:05	
Teams Fouls at 10		
Technical Fouls		
Unsportsmanlike Fouls		

	ITA	FRA
Biggest lead	3	6
Biggest scoring run	2-0 (2-0)	6-0 (6-12)
Lead changes		

LEGEND

%	Shooting Percentage	*	Game Starters	+/-	Plus Minus	AS	Assists
BS	Blocked Shots	DR	Defensive Rebounds	EFF	Efficiency	FD	Fouls Drawn
M/A	Made/Attempts	MIN	Minutes Played	OR	Offensive Rebounds	PF	Fouls
PTS	Points	ST	Steals	TO	Turnovers	TOT	Total Rebounds



Place Sidi M'Hamed  
3x3 Basketball  
Women  
Preliminary - Group C  
Match 5



THU 30 JUN 2022  
Start time 19:20

## Results

Game Duration: 21:56

### ESP 18 vs 15 TUR

Referee: Najib CHAJIDDINE (FRA)  
Umpires: Benani ANIS (ALG) Najib CHAJIDDINE (FRA)

Commissioner: Kosta ILIEV (BUL)

ESP 18  
TUR 15

#### ESP - Spain

No.	Name	MIN	PTS	S-EFF	1 Point		2 Points		Free Throws		Rebounds			AS	TO	ST	BS	PF	FD	+/-
					M/A	%	M/A	%	M/A	%	OR	DR	TOT							
*3	RODRIGUEZ DOMINGUEZ Natalia	9:30	5	0.42	3/5	60	1/6	17	0/1	0	2	2	4	1					1	4
*6	AYUSO BAGUR Aina	8:19	4	0.50	1/5	20	1/2	50	1/1	100		1	1	1						6
*11	GUERRERO ALCANTARA Carolin	8:40	7	0.88	5/6	83	1/2	50						1					1	2
*13	PUEYO MELCHOR Helena	3:35	2	0.40	1/1	100	0/2	0	1/2	50	1		1							-1
Team																				
Totals			18	0.55	10/17	59	3/12	25	2/4	50	3	3	6	3					2	

#### TUR - Turkiye

No.	Name	MIN	PTS	S-EFF	1 Point		2 Points		Free Throws		Rebounds			AS	TO	ST	BS	PF	FD	+/-
					M/A	%	M/A	%	M/A	%	OR	DR	TOT							
*1	AKALAN Feride Seval	9:44	9	0.82	5/7	71	2/3	67	0/1	0			1							-3
5	ADICAN Doga	9:11	0	0.00	0/2	0	0/4	0				1	1					3		-5
9	USTUN Deniz	8:40	5	1.00	1/1	100	2/4	50				1	1	1						-5
21	CENGIZHAN Alevna Fatma	5:10	1	0.50	1/2	50					1		1							1
Team																				
Totals			15	0.63	7/12	58	4/11	36	0/1	0	1	2	3	2				3		

	ESP	TUR
Team Fouls		3
Teams Fouls at 7		
Teams Fouls at 10		
Technical Fouls		
Unsportsmanlike Fouls		

	ESP	TUR
Biggest lead	7	
Biggest scoring run	5-0 (8-1)	5-0 (15-15)
Lead changes		1

#### LEGEND

%	Shooting Percentage	*	Game Starters	+/-	Plus Minus	AS	Assists
BS	Blocked Shots	DR	Defensive Rebounds	EFF	Efficiency	FD	Fouls Drawn
M/A	Made/Attempts	MIN	Minutes Played	OR	Offensive Rebounds	PF	Fouls
PTS	Points	ST	Steals	TO	Turnovers	TOT	Total Rebounds





THU 30 JUN 2022  
Start time 19:40

## Results

Game Duration: 20:12

### GRE 11 vs 15 SLO

Referee: Vladimir VESKOVIC (SRB)  
Umpires: Maria Giulia FORNI (ITA) Vladimir VESKOVIC (SRB)

Commissioner: Kosta ILIEV (BUL)

GRE	11
SLO	15

#### GRE - Greece

No.	Name	MIN	PTS	S-EFF	1 Point		2 Points		Free Throws		Rebounds			AS	TO	ST	BS	PF	FD	+/-
					M/A	%	M/A	%	M/A	%	OR	DR	TOT							
*4	CHATZIVASILEIOU Ioanna	8:30	2	0.29	2/2	100	0/5	0										1		-6
5	STOUPA Nefeli Soyridoula	7:27	2	0.22	0/7	0	1/2	50				1	1					2		-2
*11	KORRE Zoi	7:59	3	0.27	3/8	38	0/2	0	0/1	0	2	1	3						2	-4
*13	ANASTASOPOULOU	6:13	4	0.40	4/7	57	0/1	0	0/2	0								2	2	1
Team																				
Totals			11	0.30	9/24	38	1/10	10	0/3	0	2	2	4					5	4	

#### SLO - Slovenia

No.	Name	MIN	PTS	S-EFF	1 Point		2 Points		Free Throws		Rebounds			AS	TO	ST	BS	PF	FD	+/-
					M/A	%	M/A	%	M/A	%	OR	DR	TOT							
*3	SEVER Katja	7:00	2	0.40	2/5	40					1		1					3	1	1
*5	JERAS Ana Dora	8:27	1	0.33	1/1	100	0/2	0			1		1	1				1	1	4
*9	BURGAR Aida	8:29	4	0.40	4/7	57	0/3	0			2		2					2		4
21	BERUS Spela	6:44	8	0.57	2/4	50	2/8	25	2/2	100		2	2						2	3
Team																				
Totals			15	0.47	9/17	53	2/13	15	2/2	100	4	2	6	1				6	4	

	GRE	SLO
Team Fouls	5	6
Teams Fouls at 7		
Teams Fouls at 10		
Technical Fouls		
Unsportsmanlike Fouls		

	GRE	SLO
Biggest lead	1	4
Biggest scoring run	4-0 (7-6)	5-0 (7-11)
Lead changes		1

#### LEGEND

%	Shooting Percentage	*	Game Starters	+/-	Plus Minus	AS	Assists
BS	Blocked Shots	DR	Defensive Rebounds	EFF	Efficiency	FD	Fouls Drawn
M/A	Made/Attempts	MIN	Minutes Played	OR	Offensive Rebounds	PF	Fouls
PTS	Points	ST	Steals	TO	Turnovers	TOT	Total Rebounds



Place Sidi M'Hamed  
3x3 Basketball  
Women  
Preliminary - Group C  
Match 15



THU 30 JUN 2022  
Start time 22:40

Results

Game Duration: 19:09

TUR 10 vs 9 SLO

Referee: Vladimir VESKOVIC (SRB)  
Umpires: Maria Giulia FORNI (ITA) Vladimir VESKOVIC (SRB)

Commissioner: Kosta ILIEV (BUL)

TUR	10
SLO	9

TUR - Turkiye

No.	Name	MIN	PTS	S-EFF	1 Point		2 Points		Free Throws		Rebounds			AS	TO	ST	BS	PF	FD	+/-
					M/A	%	M/A	%	M/A	%	OR	DR	TOT							
*1	AKALAN Feride Seval	8:33	3	0.25	3/7	43	0/4	0	0/1	0	1	1	2					1	1	2
*5	ADICAN Doga	8:28	5	0.38	4/9	44	0/3	0	1/1	100		3	3	1				5	1	3
9	USTUN Deniz	5:55	1	0.25	1/1	100	0/2	0	0/1	0		1	1	1				1	2	-1
*21	CENGIZHAN Aleyna Fatma	7:18	1	0.33	1/3	33						1	1					1	1	-1
Team																				
Totals			10	0.31	9/20	45	0/9	0	1/3	33	1	6	7	2				7	5	

SLO - Slovenia

No.	Name	MIN	PTS	S-EFF	1 Point		2 Points		Free Throws		Rebounds			AS	TO	ST	BS	PF	FD	+/-
					M/A	%	M/A	%	M/A	%	OR	DR	TOT							
*3	SEVER Katja	8:17	5	0.56	2/5	40	1/2	50	1/2	50		1	1	1				3	3	-2
*5	JERAS Ana Dora	7:40	2	0.20	2/5	40	0/4	0	0/1	0	1	1	2				1	1	-2	
*9	BURGAR Aida	7:14	2	0.33	2/4	50	0/2	0				4	4					2	1	
21	BERUS Spela	6:56	0	0.00	0/1	0	0/7	0				1	1	1				1	1	
Team																				
Totals			9	0.27	6/15	40	1/15	7	1/3	33	1	7	8	1				5	7	

	TUR	SLO
Team Fouls	7	5
Teams Fouls at 7	9:38	
Teams Fouls at 10		
Technical Fouls		
Unsportsmanlike Fouls		

	TUR	SLO
Biggest lead	3	1
Biggest scoring run	3-0 (6-3)	3-0 (6-6)
Lead changes	5	

LEGEND

%	Shooting Percentage	*	Game Starters	+/-	Plus Minus	AS	Assists
BS	Blocked Shots	DR	Defensive Rebounds	EFF	Efficiency	FD	Fouls Drawn
M/A	Made/Attempts	MIN	Minutes Played	OR	Offensive Rebounds	PF	Fouls
PTS	Points	ST	Steals	TO	Turnovers	TOT	Total Rebounds



THU 30 JUN 2022  
Start time: 23:00

## Results

Game Duration: 16:19

### ESP 21 vs 13 GRE

Referee: Najib CHAJIDDINE (FRA)  
Umpires: Yasser EL HAGE (LBN) Najib CHAJIDDINE (FRA)

Commissioner: Kosta ILIEV (BUL)

ESP	21
GRE	13

#### ESP - Spain

No.	Name	MIN	PTS	S-EFF	1 Point		2 Points		Free Throws		Rebounds			AS	TO	ST	BS	PF	FD	+/-
					M/A	%	M/A	%	M/A	%	OR	DR	TOT							
*3	RODRIGUEZ DOMINGUEZ Natalia	6:33	5	0.83	3/3	100	1/3	33				1	1					3		4
*6	AYUSO BAGUR Aina	7:03	5	0.56	2/3	67	1/5	20	1/1	100	1	3	4	2				1	2	8
*11	GUERRERO ALCANTARA Carolin	8:41	5	0.45	5/8	63	0/3	0			1	1	2	1						6
13	PUEYO MELCHOR Helena	7:47	6	0.86	4/4	100	1/3	33			2	2	4	1				1		7
Team																				
Totals			21	0.64	14/18	78	3/14	21	1/1	100	4	7	11	4				5	2	

#### GRE - Greece

No.	Name	MIN	PTS	S-EFF	1 Point		2 Points		Free Throws		Rebounds			AS	TO	ST	BS	PF	FD	+/-
					M/A	%	M/A	%	M/A	%	OR	DR	TOT							
*4	CHATZIVASILEIOU Ioanna	7:37	0	0.00	0/4	0	0/4	0						1				1		-5
5	STOUPA Nefeli Spyridoula	8:34	5	0.71	1/3	33	2/4	50												-8
*11	KORRE Zoi	6:16	3	0.60	3/4	75	0/1	0			1	1	1					1		-2
*13	ANASTASOPOULOU	7:11	5	0.83	5/6	83													5	-9
Team																				
Totals			13	0.50	9/17	53	2/9	22			1	1	2					2	5	

	ESP	GRE
Team Fouls	5	2
Teams Fouls at 7		
Teams Fouls at 10		
Technical Fouls		
Unsportsmanlike Fouls		

	ESP	GRE
Biggest lead	10	
Biggest scoring run	5-0 (13-5)	3-0 (18-11)
Lead changes		

#### LEGEND

%	Shooting Percentage	*	Game Starters	+/-	Plus Minus	AS	Assists
BS	Blocked Shots	DR	Defensive Rebounds	EFF	Efficiency	FD	Fouls Drawn
M/A	Made/Attempts	MIN	Minutes Played	OR	Offensive Rebounds	PF	Fouls
PTS	Points	ST	Steals	TO	Turnovers	TOT	Total Rebounds



Place Sidi M'Hamed  
3x3 Basketball  
Women  
Preliminary - Group C  
Match 25



FRI 1 JUL 2022  
Start time 21:40

Results

Game Duration: 23:38

TUR 15 vs 13 GRE

Referee: Maria Giulia FORNI (ITA)  
Umpires: Kahil YACINE (ALG) Maria Giulia FORNI (ITA)

Commissioner: Kosta ILIEV (BUL)

TUR 15  
GRE 13

TUR - Turkiye

No.	Name	MIN	PTS	S-EFF	1 Point		2 Points		Free Throws		Rebounds			AS	TO	ST	BS	PF	FD	+/-
					M/A	%	M/A	%	M/A	%	OR	DR	TOT							
*1	AKALAN Feride Seval	8:49	9	0.56	2/8	25	2/5	40	3/3	100								2	3	2
*5	ADICAN Doga	6:47	4	0.36	2/5	40	1/3	33	0/3	0								4	1	4
9	USTUN Deniz	7:37	0	0.00	0/1	0	0/1	0	0/3	0								3	2	2
*21	CENGIZHAN Aleyna Fatma	7:22	2	0.40	1/2	50			1/3	33									2	-2
Team																				
Totals			15	0.41	5/16	31	3/9	33	4/12	33								9	8	

GRE - Greece

No.	Name	MIN	PTS	S-EFF	1 Point		2 Points		Free Throws		Rebounds			AS	TO	ST	BS	PF	FD	+/-
					M/A	%	M/A	%	M/A	%	OR	DR	TOT							
*4	CHATZIVASILEIOU Ioanna	8:16	4	0.44	0/3	0	1/4	25	2/2	100								1	1	
5	STOUPA Nefeli Spyridoula	8:43	3	0.38	3/5	60	0/2	0	0/1	0								5	2	1
*11	KORRE Zoi	6:23	3	0.33	2/5	40	0/2	0	1/2	50								1	2	-1
13	ANASTASOPOULOU	6:50	3	0.27	2/7	29			1/4	25								1	4	-4
Team																				
Totals			13	0.35	7/20	35	1/8	13	4/9	44								8	9	

	TUR	GRE
Team Fouls	9	8
Teams Fouls at 7	6:19	6:51
Teams Fouls at 10		
Technical Fouls		
Unsportsmanlike Fouls		

	TUR	GRE
Biggest lead	5	1
Biggest scoring run	6-0 (7-2)	5-0 (13-13)
Lead changes	2	

LEGEND

% Shooting Percentage      \* Game Starters      +/- Plus Minus      AS Assists  
 BS Blocked Shots      DR Defensive Rebounds      EFF Efficiency      FD Fouls Drawn  
 M/A Made/Attempts      MIN Minutes Played      OR Offensive Rebounds      PF Fouls  
 PTS Points      ST Steals      TO Turnovers      TOT Total Rebounds



Place Sidi M'Hamed  
3x3 Basketball  
Women  
Preliminary - Group C  
Match 26



FRI 1 JUL 2022  
Start time 22:00

## Results

Game Duration: 17:24

### SLO 12 vs 16 ESP

Referee: Najib CHAJIDDINE (FRA)  
Umpires: Benani ANIS (ALG) Najib CHAJIDDINE (FRA)

Commissioner: Kosta ILIEV (BUL)

SLO 12  
ESP 16

#### SLO - Slovenia

No.	Name	MIN	PTS	S-EFF	1 Point		2 Points		Free Throws		Rebounds			AS	TO	ST	BS	PF	FD	+/-
					M/A	%	M/A	%	M/A	%	OR	DR	TOT							
*3	SEVER Katja	5:46	0	0.00	0/1	0	0/3	0										2	1	-2
*5	JERAS Ana Dora	7:51	0	0.00	0/2	0												1		-5
*9	BURGAR Aida	8:48	4	0.36	1/6	17	1/4	25	1/1	100									1	-3
21	BERUS Spela	8:18	8	0.73	2/2	100	3/8	38	0/1	0								1		-4
Team																				
Totals			12	0.43	3/11	27	4/15	27	1/2	50								4	2	

#### ESP - Spain

No.	Name	MIN	PTS	S-EFF	1 Point		2 Points		Free Throws		Rebounds			AS	TO	ST	BS	PF	FD	+/-
					M/A	%	M/A	%	M/A	%	OR	DR	TOT							
*3	RODRIGUEZ DOMINGUEZ Natalia	8:12	7	0.58	3/6	50	2/6	33										2		3
*6	AYUSO BAGUR Aina	8:06	3	0.33	1/5	20	1/3	33	0/1	0								1	3	3
*11	GUERRERO ALCANTARA Carolin	8:41	3	0.60	3/4	75	0/1	0											1	4
13	PUEYO MELCHOR Helena	6:08	3	0.38	3/4	75	0/4	0												4
Team																				
Totals			16	0.47	10/19	53	3/14	21	0/1	0								3	4	

	SLO	ESP
Team Fouls	4	3
Teams Fouls at 7		
Teams Fouls at 10		
Technical Fouls		
Unsportsmanlike Fouls		

	SLO	ESP
Biggest lead	4	4
Biggest scoring run	5-0 (12-11)	5-0 (7-11)
Lead changes	3	

#### LEGEND

%	Shooting Percentage	*	Game Starters	+/-	Plus Minus	AS	Assists
BS	Blocked Shots	DR	Defensive Rebounds	EFF	Efficiency	FD	Fouls Drawn
M/A	Made/Attempts	MIN	Minutes Played	OR	Offensive Rebounds	PF	Fouls
PTS	Points	ST	Steals	TO	Turnovers	TOT	Total Rebounds



Place Sidi M'Hamed  
3x3 Basketball  
Women  
Quarter-finals  
Match 34



SAT 2 JUL 2022  
Start time 20:00

Results

Game Duration: 18:10

SRB 11 vs 17 ITA

Referee: Najib CHAJIDDINE (FRA)  
Umpires: Kahil YACINE (ALG) Najib CHAJIDDINE (FRA)

Commissioner: Kosta ILIEV (BUL)

SRB 11  
ITA 17

SRB - Serbia

No.	Name	MIN	PTS	S-EFF	1 Point		2 Points		Free Throws		Rebounds			AS	TO	ST	BS	PF	FD	+/-
					M/A	%	M/A	%	M/A	%	OR	DR	TOT							
*3	RADULOVIC Lena	7:58	7	0.70	0/3	0	3/6	50	1/1	100	2	3	5	3	3			1	1	-3
*9	CURAKOVIC Ivana	6:35	0	0.00	0/2	0	0/3	0			2		2					3		-7
*22	JELIC Tijana	9:23	4	0.40	3/5	60	0/3	0	1/2	50		6	6		1			2	2	-8
25	TESIC Nina	6:34	0	0.00	0/4	0						2	2		1	1		1		
Team																				
Totals			11	0.38	3/14	21	3/12	25	2/3	67	4	11	15	4	4	1		7	3	

ITA - Italy

No.	Name	MIN	PTS	S-EFF	1 Point		2 Points		Free Throws		Rebounds			AS	TO	ST	BS	PF	FD	+/-
					M/A	%	M/A	%	M/A	%	OR	DR	TOT							
*1	DEL PERO Beatrice	7:58	3	0.50	1/4	25	1/2	50			1	3	4	1	1				1	6
*14	MADERA Sara	8:07	9	0.64	4/8	50	1/2	50	3/4	75	1	3	4	1				1	3	7
23	BONGIORNO Giulia	8:24	1	0.13	1/4	25	0/4	0										1		4
*28	SMORTO Giovanna Elena	6:57	4	1.00	4/4	100					1	1	2			1	2	1	3	7
Team																				
Totals			17	0.53	10/20	50	2/8	25	3/4	75	3	7	10	5	1	1	2	3	7	

	SRB	ITA
Team Fouls	7	3
Teams Fouls at 7	9:25	
Teams Fouls at 10		
Technical Fouls		
Unsportsmanlike Fouls		

	SRB	ITA
Biggest lead		6
Biggest scoring run	3-0 (6-9)	6-0 (0-6)
Lead changes		

LEGEND

% Shooting Percentage      \* Game Starters      +/- Plus Minus      AS Assists  
 BS Blocked Shots      DR Defensive Rebounds      EFF Efficiency      FD Fouls Drawn  
 M/A Made/Attempts      MIN Minutes Played      OR Offensive Rebounds      PF Fouls  
 PTS Points      ST Steals      TO Turnovers      TOT Total Rebounds



SAT 2 JUL 2022  
Start time 21:40

## Results

Game Duration: 15:38

### ESP 22 vs 6 TUN

Referee: Aimeur OUSSAMA (ALG)  
Umpires: Kahil YACINE (ALG) Aimeur OUSSAMA (ALG)

Commissioner: Kosta ILIEV (BUL)

ESP	22
TUN	6

#### ESP - Spain

No.	Name	MIN	PTS	S-EFF	1 Point		2 Points		Free Throws		Rebounds			AS	TO	ST	BS	PF	FD	+/-
					M/A	%	M/A	%	M/A	%	OR	DR	TOT							
*3	RODRIGUEZ DOMINGUEZ Natalia	7:05	6	0.55	3/5	60	1/4	25	1/2	50	1	2	3	3				1	2	14
*6	AYUSO BAGUR Aina	7:23	6	0.67	1/3	33	2/5	40	1/1	100		2	2	1	1			2	2	10
*11	GUERRERO ALCANTARA Carolin	7:39	7	0.88	3/5	60	2/3	67			1	2	3		1	1		1	1	16
13	PUEYO MELCHOR Helena	5:43	3	0.38	1/4	25	0/2	0	2/2	100	1	3	4	2		2	1	1	1	8
Team																				
Totals			22	0.61	8/17	47	5/14	36	4/5	80	3	9	12	6	1	3	2	4	6	

#### TUN - Tunisia

No.	Name	MIN	PTS	S-EFF	1 Point		2 Points		Free Throws		Rebounds			AS	TO	ST	BS	PF	FD	+/-
					M/A	%	M/A	%	M/A	%	OR	DR	TOT							
*6	BEN RHOUMA Hibet Allah	6:16	0	0.00	0/1	0	0/1	0				2	2	2				1	1	-13
13	BEN GARA Sirine	7:35	1	1.00	1/1	100						2	2	1						-13
*24	SHILI Marwa	6:54	2	0.18	2/7	29	0/3	0	0/1	0	1	3	4	1	4	1		2	1	-9
*31	JDIDI BAGANE Abir	6:32	3	0.38	3/6	50	0/2	0			1	3	4					2	1	-14
Team																				
Totals			6	0.27	6/15	40	0/6	0	0/1	0	2	8	10	4	6	1		5	3	

	ESP	TUN
Team Fouls	4	5
Teams Fouls at 7		
Teams Fouls at 10		
Technical Fouls		
Unsportsmanlike Fouls		

	ESP	TUN
Biggest lead	16	
Biggest scoring run	10-0 (15-3)	1-0 (1-1)
Lead changes		2

#### LEGEND

%	Shooting Percentage	*	Game Starters	+/-	Plus Minus	AS	Assists
BS	Blocked Shots	DR	Defensive Rebounds	EFF	Efficiency	FD	Fouls Drawn
M/A	Made/Attempts	MIN	Minutes Played	OR	Offensive Rebounds	PF	Fouls
PTS	Points	ST	Steals	TO	Turnovers	TOT	Total Rebounds



Place Sidi M'Hamed  
3x3 Basketball  
Women  
Quarter-finals  
Match 38



SAT 2 JUL 2022  
Start time 21:20

Results

Game Duration: 20:47

POR 10 vs 13 TUR

Referee: Najib CHAJIDDINE (FRA)  
Umpires: Benani ANIS (ALG) Najib CHAJIDDINE (FRA)

Commissioner: Kosta ILIEV (BUL)

POR	10
TUR	13

POR - Portugal

No.	Name	MIN	PTS	S-EFF	1 Point		2 Points		Free Throws		Rebounds			AS	TO	ST	BS	PF	FD	+/-
					M/A	%	M/A	%	M/A	%	OR	DR	TOT							
5	DE LIMA VIEGAS Raquel	7:26	4	0.36	2/7	29	1/4	25				1	1							-5
*6	MOTA MARTINS Alice	8:13	2	0.29	1/4	25	0/2	0	1/1	100	1	2	3				1	4	1	-4
*11	BARATA SILVA Mariana	8:48	1	0.07	1/12	8	0/1	0	0/2	0	3	2	5	1			1	1	4	-2
*23	MAIO MARINHO Maria	5:56	3	0.38	1/3	33	0/2	0	2/3	67	2		2			1		1	2	1
Team																				
Totals			10	0.24	5/26	19	1/9	11	3/6	50	6	5	11	1		1	2	6	7	

TUR - Turkiye

No.	Name	MIN	PTS	S-EFF	1 Point		2 Points		Free Throws		Rebounds			AS	TO	ST	BS	PF	FD	+/-
					M/A	%	M/A	%	M/A	%	OR	DR	TOT							
*1	AKALAN Feride Seval	8:27	7	0.41	3/9	33	2/7	29	0/1	0	2	8	10	1	1			1	3	2
*5	ADICAN Doga	7:16	5	0.56	5/7	71	0/2	0			1	3	4	1	1			4	1	2
9	USTUN Deniz	6:36	1	0.50	1/1	100	0/1	0				4	4					1		3
*21	CENGIZHAN Alevna Fatma	7:47	0	0.00	0/2	0					3	2	5		1			1	2	3
Team																				
Totals			13	0.43	9/19	47	2/10	20	0/1	0	6	17	23	2	3			7	6	

	POR	TUR
Team Fouls	6	7
Teams Fouls at 7		6:03
Teams Fouls at 10		
Technical Fouls		
Unsportsmanlike Fouls		

	POR	TUR
Biggest lead		4
Biggest scoring run	3-0 (9-9)	4-0 (9-13)
Lead changes		

LEGEND

%	Shooting Percentage	*	Game Starters	+/-	Plus Minus	AS	Assists
BS	Blocked Shots	DR	Defensive Rebounds	EFF	Efficiency	FD	Fouls Drawn
M/A	Made/Attempts	MIN	Minutes Played	OR	Offensive Rebounds	PF	Fouls
PTS	Points	ST	Steals	TO	Turnovers	TOT	Total Rebounds





SAT 2 JUL 2022  
Start time: 20:20

## Results

Game Duration: 20:27

### FRA 20 vs 5 SLO

Referee: Vladimir VESKOVIC (SRB)  
Umpires: Aimeur OUSSAMA (ALG) Vladimir VESKOVIC (SRB)

Commissioner: Kosta ILIEV (BUL)

FRA	20
SLO	5

#### FRA - France

No.	Name	MIN	PTS	S-EFF	1 Point		2 Points		Free Throws		Rebounds			AS	TO	ST	BS	PF	FD	+/-
					M/A	%	M/A	%	M/A	%	OR	DR	TOT							
*0	NGO NDJOCK Anna Sara	9:22	5	0.36	4/7	57	0/3	0	1/4	25	4	1	5	2	2	1		2	2	14
*5	PARDON Marie Helene	8:39	6	0.55	5/8	63	0/1	0	1/2	50	2	6	8					1	3	13
6	PEYTOUR-RAISON Emma	7:13	7	0.64	3/5	60	2/6	33			3	1	4						1	10
*7	DROGUET Camille Marie	5:59	2	0.29	0/4	0	0/1	0	2/2	100	2		2		1				2	11
Team																				
Totals			20	0.47	12/24	50	2/11	18	4/8	50	11	8	19	2	3	1		3	8	

#### SLO - Slovenia

No.	Name	MIN	PTS	S-EFF	1 Point		2 Points		Free Throws		Rebounds			AS	TO	ST	BS	PF	FD	+/-
					M/A	%	M/A	%	M/A	%	OR	DR	TOT							
*3	SEVER Katja	6:51	2	0.33	2/5	40	0/1	0						1	1			3		-11
*5	JERAS Ana Dora	7:09	0	0.00	0/3	0											1	3	1	-11
*9	BURGAR Aida	8:56	3	0.27	3/11	27					1	3	4		1			2	1	-14
21	BERUS Spela	7:07	0	0.00			0/1	0				3	3					1		-9
Team																				
Totals			5	0.24	5/19	26	0/2	0			1	6	7	1	2		1	10	2	

	FRA	SLO
Team Fouls	3	10
Teams Fouls at 7		6:43
Teams Fouls at 10		9:50
Technical Fouls	1	1
Unsportsmanlike Fouls		1

	FRA	SLO
Biggest lead	15	
Biggest scoring run	9-0 (14-3)	2-0 (14-5)
Lead changes		1

#### LEGEND

%	Shooting Percentage	*	Game Starters	+/-	Plus Minus	AS	Assists
BS	Blocked Shots	DR	Defensive Rebounds	EFF	Efficiency	FD	Fouls Drawn
M/A	Made/Attempts	MIN	Minutes Played	OR	Offensive Rebounds	PF	Fouls
PTS	Points	ST	Steals	TO	Turnovers	TOT	Total Rebounds



Place Sidi M'Hamed  
3x3 Basketball  
Women  
Semi-finals  
Match 45



SUN 3 JUL 2022  
Start time 17:30

Results

Game Duration: 19:35

ITA 11 vs 16 ESP

Referee: RIBEIRO P. (POR)  
Umpires: Aimeur OUSSAMA (ALG) RIBEIRO P. (POR)

Commissioner: Kosta ILIEV (BUL)

ITA	11
ESP	16

ITA - Italy

No.	Name	MIN	PTS	S-EFF	1 Point		2 Points		Free Throws		Rebounds			AS	TO	ST	BS	PF	FD	+/-
					M/A	%	M/A	%	M/A	%	OR	DR	TOT							
*1	DEL PERO Beatrice	8:05	6	0.50	4/8	50	1/3	33	0/1	0	2	2						1	2	-3
*14	MADERA Sara	8:14	4	0.33	1/7	14	1/3	33	1/2	50	2	4	6	2	1			1	2	-4
23	BONGIORNO Giulia	6:50	0	0.00	0/5	0	0/3	0	0/1	0	1	2	3					2	1	-6
*28	SMORTO Giovanna Elena	7:05	1	0.17	1/5	20			0/1	0	2	2	4	1	1	1			1	-2
Team																				
Totals			11	0.28	6/25	24	2/9	22	1/5	20	7	8	15	1	3	2		4	6	

ESP - Spain

No.	Name	MIN	PTS	S-EFF	1 Point		2 Points		Free Throws		Rebounds			AS	TO	ST	BS	PF	FD	+/-
					M/A	%	M/A	%	M/A	%	OR	DR	TOT							
*3	RODRIGUEZ DOMINGUEZ Natalia	7:05	5	0.63	1/3	33	2/5	40			2	2	2				1			3
*6	AYUSO BAGUR Aina	7:25	1	0.20	1/2	50	0/3	0			1	2	3	6	1			3		5
*11	GUERRERO ALCANTARA Carolin	8:14	6	0.60	6/9	67			0/1	0	3	3	6	2	3			1	4	4
13	PUEYO MELCHOR Helena	7:40	4	0.67	2/2	100	1/4	25				3	3	1	1			2		5
Team																				
Totals			16	0.55	10/16	63	3/12	25	0/1	0	4	10	14	11	5		1	6	4	

	ITA	ESP
Team Fouls	4	6
Teams Fouls at 7		
Teams Fouls at 10		
Technical Fouls		
Unsportsmanlike Fouls		

	ITA	ESP
Biggest lead	1	6
Biggest scoring run	2-0 (3-6)	6-0 (1-6)
Lead changes	1	

LEGEND

%	Shooting Percentage	*	Game Starters	+/-	Plus Minus	AS	Assists
BS	Blocked Shots	DR	Defensive Rebounds	EFF	Efficiency	FD	Fouls Drawn
M/A	Made/Attempts	MIN	Minutes Played	OR	Offensive Rebounds	PF	Fouls
PTS	Points	ST	Steals	TO	Turnovers	TOT	Total Rebounds



Place Sidi M'Hamed  
3x3 Basketball  
Women  
Semi-finals  
Match 46



SUN 3 JUL 2022  
Start time 17:50

Results

Game Duration: 19:36

TUR 10 vs 19 FRA

Referee: Maria Giulia FORNI (ITA)  
Umpires: Kahil YACINE (ALG) Maria Giulia FORNI (ITA)

Commissioner: Kosta ILIEV (BUL)

TUR	10
FRA	19

TUR - Turkiye

No.	Name	MIN	PTS	S-EFF	1 Point		2 Points		Free Throws		Rebounds			AS	TO	ST	BS	PF	FD	+/-
					M/A	%	M/A	%	M/A	%	OR	DR	TOT							
*1	AKALAN Feride Seval	7:56	7	0.47	5/9	56	0/3	0	2/3	67	1	2	3		4			3	2	-7
*5	ADICAN Doga	8:55	2	0.29	2/5	40	0/2	0			2	4	6		6			1	1	-7
*9	USTUN Deniz	7:41									1	2	3	1				1		-6
21	CENGIZHAN Aleyna Fatma	5:40	1	0.25	1/4	25					2	1	3		1			1		-7
Team																				
Totals			10	0.38	8/18	44	0/5	0	2/3	67	6	9	15	1	11			6	3	

FRA - France

No.	Name	MIN	PTS	S-EFF	1 Point		2 Points		Free Throws		Rebounds			AS	TO	ST	BS	PF	FD	+/-
					M/A	%	M/A	%	M/A	%	OR	DR	TOT							
*0	NGO NDJOCK Anna Sara	7:08	5	0.50	3/4	75	1/4	25	0/2	0	1	2	3	2		2		1		6
*5	PARDON Marie Helene	8:04	4	0.44	2/6	33	1/3	33			2	3	5	4						8
6	PEYTOUR-RAISON Emma	7:16	3	0.43	1/2	50	1/5	20				2	2	1	1					5
*7	DROGUET Camille Marie	8:26	7	0.44	5/13	38			2/3	67	5		5	1	1	2		2	6	10
Team																		1		
Totals			19	0.45	11/25	44	3/12	25	2/5	40	8	7	15	8	2	4		4	6	

	TUR	FRA
Team Fouls	6	4
Teams Fouls at 7		
Teams Fouls at 10		
Technical Fouls		
Unsportsmanlike Fouls		1

	TUR	FRA
Biggest lead	1	9
Biggest scoring run	3-0 (6-5)	6-0 (10-19)
Lead changes	3	

LEGEND

%	Shooting Percentage	*	Game Starters	+/-	Plus Minus	AS	Assists
BS	Blocked Shots	DR	Defensive Rebounds	EFF	Efficiency	FD	Fouls Drawn
M/A	Made/Attempts	MIN	Minutes Played	OR	Offensive Rebounds	PF	Fouls
PTS	Points	ST	Steals	TO	Turnovers	TOT	Total Rebounds



SUN 3 JUL 2022  
Start time 18:50

## Results

Game Duration: 18:45

### SRB 11 vs 13 TUN

Referee: Aimeur OUSSAMA (ALG)  
Umpires: Benani ANIS (ALG) Aimeur OUSSAMA (ALG)

Commissioner: Kosta ILIEV (BUL)

SRB 11  
TUN 13

#### SRB - Serbia

No.	Name	MIN	PTS	S-EFF	1 Point		2 Points		Free Throws		Rebounds			AS	TO	ST	BS	PF	FD	+/-
					M/A	%	M/A	%	M/A	%	OR	DR	TOT							
3	RADULOVIC Lena	7:40	6	0.60	2/6	33	2/4	50						1				1		
*9	CURAKOVIC Ivana	6:52	1	0.25	0/1	0	0/2	0	1/1	100		1	1					3	1	4
*22	JELIC Tijana	8:42	2	0.22	1/4	25	0/4	0	1/1	100		2	2					2	2	-3
*25	TESIC Nina	6:48	2	0.50	2/3	67	0/1	0			1		1					1	1	-5
Team																				
Totals			11	0.41	5/14	36	2/11	18	2/2	100	1	3	4	1				7	4	

#### TUN - Tunisia

No.	Name	MIN	PTS	S-EFF	1 Point		2 Points		Free Throws		Rebounds			AS	TO	ST	BS	PF	FD	+/-
					M/A	%	M/A	%	M/A	%	OR	DR	TOT							
*6	BEN RHOUMA Hibet Allah	8:27	4	0.40	2/7	29	0/1	0	2/2	100								1	3	
13	BEN GARA Sirine	7:39	5	0.83	5/5	100	0/1	0			3	2	5					1		3
*24	SHILI Marwa	8:39	1	0.07	1/9	11	0/5	0			2		2	1				1	2	3
*31	JDIDI BAGANE Abir	5:19	2	0.29	2/6	33			0/1	0	1	4	5					1	2	1
Team			1		1/1	100														
Totals			13	0.34	11/28	39	0/7	0	2/3	67	6	6	12	1				4	7	

	SRB	TUN
Team Fouls	7	4
Teams Fouls at 7	7:47	
Teams Fouls at 10		
Technical Fouls		
Unsportsmanlike Fouls		

	SRB	TUN
Biggest lead	3	3
Biggest scoring run	3-0 (7-4)	5-0 (8-11)
Lead changes		2

#### LEGEND

%	Shooting Percentage	*	Game Starters	+/-	Plus Minus	AS	Assists
BS	Blocked Shots	DR	Defensive Rebounds	EFF	Efficiency	FD	Fouls Drawn
M/A	Made/Attempts	MIN	Minutes Played	OR	Offensive Rebounds	PF	Fouls
PTS	Points	ST	Steals	TO	Turnovers	TOT	Total Rebounds



SUN 3 JUL 2022  
Start time 19:10

## Results

Game Duration: 17:31

### POR 11 vs 8 SLO

Referee: Kahil YACINE (ALG)  
Umpires: Benani ANIS (ALG) Kahil YACINE (ALG)

Commissioner: Kosta ILIEV (BUL)

POR	11
SLO	8

#### POR - Portugal

No.	Name	MIN	PTS	S-EFF	1 Point		2 Points		Free Throws		Rebounds			AS	TO	ST	BS	PF	FD	+/-
					M/A	%	M/A	%	M/A	%	OR	DR	TOT							
*5	DE LIMA VIEGAS Raquel	6:52	3	0.30	3/8	38	0/2	0												1
6	MOTA MARTINS Alice	8:24	1	0.14	1/7	14					1	3	4					1		2
*11	BARATA SILVA Mariana	8:17	3	0.27	3/10	30			0/1	0		3	3							5
*23	MAIO MARINHO Maria	6:27	3	0.60	3/4	75	0/1	0										2	1	1
Team			1		1/1	100														
Totals			11	0.32	11/30	37	0/3	0	0/1	0	1	6	7					3	2	

#### SLO - Slovenia

No.	Name	MIN	PTS	S-EFF	1 Point		2 Points		Free Throws		Rebounds			AS	TO	ST	BS	PF	FD	+/-
					M/A	%	M/A	%	M/A	%	OR	DR	TOT							
*3	SEVER Katja	7:09	2	0.40	0/1	0	1/4	25										1		-2
*5	JERAS Ana Dora	7:21	2	0.50	2/3	67	0/1	0			1	1	2					1		-4
9	BURGAR Aida	7:05	1	0.10	1/7	14	0/2	0	0/1	0	1	2	3					1	2	-2
*21	BERUS Spela	9:20	3	0.43	1/2	50	1/5	20			2	1	3	1					1	-3
Team																				
Totals			8	0.31	4/13	31	2/12	17	0/1	0	4	4	8	1				2	3	

	POR	SLO
Team Fouls	3	2
Teams Fouls at 7		
Teams Fouls at 10		
Technical Fouls		
Unsportsmanlike Fouls		

	POR	SLO
Biggest lead	3	1
Biggest scoring run	3-0 (3-1)	2-0 (3-3)
Lead changes	2	

#### LEGEND

%	Shooting Percentage	*	Game Starters	+/-	Plus Minus	AS	Assists
BS	Blocked Shots	DR	Defensive Rebounds	EFF	Efficiency	FD	Fouls Drawn
M/A	Made/Attempts	MIN	Minutes Played	OR	Offensive Rebounds	PF	Fouls
PTS	Points	ST	Steals	TO	Turnovers	TOT	Total Rebounds



SAT 2 JUL 2022  
Start time 19:40

## Results

Game Duration: 17:51

### EGY 11 vs 17 GRE

Referee: Aimeur OUSSAMA (ALG)  
Umpires: Benani ANIS (ALG) Aimeur OUSSAMA (ALG)

Commissioner: Kosta ILIEV (BUL)

EGY 11  
GRE 17

#### EGY - Egypt

No.	Name	MIN	PTS	S-EFF	1 Point		2 Points		Free Throws		Rebounds			AS	TO	ST	BS	PF	FD	+/-
					M/A	%	M/A	%	M/A	%	OR	DR	TOT							
*8	KABIL Fatma	6:47	3	0.33	3/5	60	0/4	0			1	1	2		1				1	-10
*10	BADAWY Ingv	6:42	0	0.00	0/1	0	0/2	0			1	1	2					2	1	3
12	OWEIS Radwa	8:25	4	0.57	4/6	67	0/1	0				1	1					1		-7
*44	HUSSEIN Yara	8:04	4	0.44	2/5	40	1/4	25			2	3	5					2	2	-4
Team																				
Totals			11	0.39	9/17	53	1/11	9			4	6	10		1			5	4	

#### GRE - Greece

No.	Name	MIN	PTS	S-EFF	1 Point		2 Points		Free Throws		Rebounds			AS	TO	ST	BS	PF	FD	+/-
					M/A	%	M/A	%	M/A	%	OR	DR	TOT							
*4	CHATZIVASILEIOU Ioanna	7:00	3	0.38	3/4	75	0/4	0			3	1	4	5	1			1		7
5	STOUPA Nefeli Spyridoula	7:04	2	0.40	0/1	0	1/4	25			1	2	3				1	2		1
*11	KORRE Zoi	7:38	5	0.56	1/3	33	2/6	33				3	3	2					1	3
*13	ANASTASOPOULOU	8:16	7	0.58	5/8	63	0/1	0	2/3	67	2	4	6	1				1	4	9
Team																				
Totals			17	0.50	9/16	56	3/15	20	2/3	67	6	10	16	8	1	1		4	5	

	EGY	GRE
Team Fouls	5	4
Teams Fouls at 7		
Teams Fouls at 10		
Technical Fouls		
Unsportsmanlike Fouls		

	EGY	GRE
Biggest lead	2	7
Biggest scoring run	3-0 (9-12)	7-0 (6-12)
Lead changes	3	

#### LEGEND

%	Shooting Percentage	*	Game Starters	+/-	Plus Minus	AS	Assists
BS	Blocked Shots	DR	Defensive Rebounds	EFF	Efficiency	FD	Fouls Drawn
M/A	Made/Attempts	MIN	Minutes Played	OR	Offensive Rebounds	PF	Fouls
PTS	Points	ST	Steals	TO	Turnovers	TOT	Total Rebounds



Place Sidi M'Hamed  
3x3 Basketball  
Women  
Gold-medal Match  
Match 59



SUN 3 JUL 2022  
Start time 22:10

## Results

Game Duration: 19:48

### ESP 12 vs 11 FRA (10-10; 2-1)

Referee: Vladimir VESKOVIC (SRB)  
Umpires: Maria Giulia FORNI (ITA) Vladimir VESKOVIC (SRB)

Commissioner: Kosta ILIEV (BUL)

OT	
ESP	10
FRA	10
	12
	11

#### ESP - Spain

No.	Name	MIN	PTS	S-EFF	1 Point		2 Points		Free Throws		Rebounds			AS	TO	ST	BS	PF	FD	+/-
					M/A	%	M/A	%	M/A	%	OR	DR	TOT							
*3	RODRIGUEZ DOMINGUEZ Natalia	7:50	1	0.25	1/3	33	0/1	0			2	1	3		1				2	-2
*6	AYUSO BAGUR Aina	8:37	4	0.40	4/9	44	0/1	0				1	1		3	1		3		-1
*11	GUERRERO ALCANTARA Carolin	7:41	2	0.33	2/5	40	0/1	0				3	3		1		1		2	5
13	PUEYO MELCHOR Helena	6:04	5	0.56	4/5	80	0/3	0	1/1	100		4	4		1		2	1	2	1
Team																				
Totals			12	0.41	11/22	50	0/6	0	1/1	100	2	9	11	1	6	1	3	4	6	

#### FRA - France

No.	Name	MIN	PTS	S-EFF	1 Point		2 Points		Free Throws		Rebounds			AS	TO	ST	BS	PF	FD	+/-
					M/A	%	M/A	%	M/A	%	OR	DR	TOT							
*0	NGO NDJOCK Anna Sara	7:43	6	0.43	4/8	50	1/6	17			2	3	5	1	3	1		2		1
*5	PARDON Marie Helene	8:12	4	0.67	2/4	50	1/2	50				4	4		1	2				-3
6	PEYTOUR-RAISON Emma	7:47	0	0.00	0/2	0			0/1	0		2	2		1			2	1	1
*7	DROGUET Camille Marie	7:17	1	0.17	1/4	25	0/2	0			4	2	6	1	1	1		2	3	1
Team																				
Totals			11	0.38	7/18	39	2/10	20	0/1	0	6	11	17	2	6	4		6	4	

	ESP	FRA
Team Fouls	4	6
Teams Fouls at 7		
Teams Fouls at 10		
Technical Fouls		
Unsportsmanlike Fouls		

	ESP	FRA
Biggest lead	3	2
Biggest scoring run	5-0 (7-4)	3-0 (2-4)
Lead changes	8	

#### LEGEND

%	Shooting Percentage	*	Game Starters	+/-	Plus Minus	AS	Assists
BS	Blocked Shots	DR	Defensive Rebounds	EFF	Efficiency	FD	Fouls Drawn
M/A	Made/Attempts	MIN	Minutes Played	OR	Offensive Rebounds	PF	Fouls
PTS	Points	ST	Steals	TO	Turnovers	TOT	Total Rebounds



SUN 3 JUL 2022  
Start time 21:30

## Results

Game Duration: 19:14

### ITA 14 vs 12 TUR

Referee: RIBEIRO P. (POR)  
Umpires: Benani ANIS (ALG) RIBEIRO P. (POR)

Commissioner: Kosta ILIEV (BUL)

ITA 14  
TUR 12

#### ITA - Italy

No.	Name	MIN	PTS	S-EFF	1 Point		2 Points		Free Throws		Rebounds			AS	TO	ST	BS	PF	FD	+/-
					M/A	%	M/A	%	M/A	%	OR	DR	TOT							
*1	DEL PERO Beatrice	6:23	0	0.00	0/2	0			0/1	0	2	2	2	1					1	-1
*14	MADERA Sara	8:35	10	0.63	9/13	69	0/1	0	1/2	50	1	6	7	1	1				4	3
23	BONGIORNO Giulia	8:44	2	0.25	0/6	0	1/2	50			2	2		1	1			3	2	2
*28	SMORTO Giovanna Elena	7:28	2	0.29	2/5	40			0/2	0	4	3	7	1	1			2	1	1
Team																				
Totals			14	0.41	11/26	42	1/3	33	1/5	20	5	13	18	3	4	2		5	8	

#### TUR - Turkiye

No.	Name	MIN	PTS	S-EFF	1 Point		2 Points		Free Throws		Rebounds			AS	TO	ST	BS	PF	FD	+/-
					M/A	%	M/A	%	M/A	%	OR	DR	TOT							
*1	AKALAN Feride Seval	8:11	0	0.00	0/4	0	0/5	0			5	5	2	3				2	1	-4
*5	ADICAN Doga	7:58	8	0.53	4/9	44	1/3	33	2/3	67	1	4	5	1	2	1		3	3	
9	USTUN Deniz	8:12	3	0.60	1/1	100	1/3	33	0/1	0	2	2			1				1	-1
*21	CENGIZHAN Alevna Fatma	6:13	1	0.50	1/2	50					1	2	3					3		-1
Team																				
Totals			12	0.39	6/16	38	2/11	18	2/4	50	2	13	15	3	5	2		8	5	

	ITA	TUR
Team Fouls	5	8
Teams Fouls at 7		7:48
Teams Fouls at 10		
Technical Fouls		
Unsportsmanlike Fouls		

	ITA	TUR
Biggest lead	6	
Biggest scoring run	6-0 (6-0)	3-0 (8-5)
Lead changes		

#### LEGEND

%	Shooting Percentage	*	Game Starters	+/-	Plus Minus	AS	Assists
BS	Blocked Shots	DR	Defensive Rebounds	EFF	Efficiency	FD	Fouls Drawn
M/A	Made/Attempts	MIN	Minutes Played	OR	Offensive Rebounds	PF	Fouls
PTS	Points	ST	Steals	TO	Turnovers	TOT	Total Rebounds





SUN 3 JUL 2022  
Start time 20:30

## Results

Game Duration: 29:32

### TUN 6 vs 13 POR

Referee: Kahil YACINE (ALG)  
Umpires: Maria Giulia FORNI (ITA) Kahil YACINE (ALG)

Commissioner: Kosta ILIEV (BUL)

TUN	6
POR	13

#### TUN - Tunisia

No.	Name	MIN	PTS	S-EFF	1 Point		2 Points		Free Throws		Rebounds			AS	TO	ST	BS	PF	FD	+/-
					M/A	%	M/A	%	M/A	%	OR	DR	TOT							
*6	BEN RHOUMA Hibet Allah	9:48	2	0.33			1/6	17			1	3	4	1	2			1	1	-7
*13	BEN GARA Sirine	6:45	0	0.00	0/1	0						4	4		2					-3
*24	SHILI Marwa	10:00	2	0.18	1/7	14	0/3	0	1/1	100		2	2	1	4			2	4	-7
31	JDIDI BAGANE Abir	3:54	2	0.40	1/4	25			1/1	100	1	1	2	1	2			2	2	-3
Team																				
Totals			6	0.26	2/12	17	1/9	11	2/2	100	2	10	12	3	10			5	7	

#### POR - Portugal

No.	Name	MIN	PTS	S-EFF	1 Point		2 Points		Free Throws		Rebounds			AS	TO	ST	BS	PF	FD	+/-
					M/A	%	M/A	%	M/A	%	OR	DR	TOT							
*5	DE LIMA VIEGAS Raquel	7:00	4	0.67	4/5	80	0/1	0			1	2	3	2	1	2			1	4
*6	MOTA MARTINS Alice	7:00	2	0.40	1/4	25			1/1	100	2	2			1			3	2	3
*11	BARATA SILVA Mariana	8:49	3	0.38	2/7	29			1/1	100		1	1	1		2	1	3	1	7
23	MAIO MARINHO Maria	7:32	4	0.40	3/7	43	0/2	0	1/1	100		2	2			1	1	1	1	7
Team																				
Totals			13	0.45	10/23	43	0/3	0	3/3	100	3	5	8	3	1	5	2	7	5	

	TUN	POR
Team Fouls	5	7
Teams Fouls at 7		8:25
Teams Fouls at 10		
Technical Fouls		
Unsportsmanlike Fouls		

	TUN	POR
Biggest lead	1	7
Biggest scoring run	2-0 (3-2)	5-0 (4-8)
Lead changes	2	

#### LEGEND

%	Shooting Percentage	*	Game Starters	+/-	Plus Minus	AS	Assists
BS	Blocked Shots	DR	Defensive Rebounds	EFF	Efficiency	FD	Fouls Drawn
M/A	Made/Attempts	MIN	Minutes Played	OR	Offensive Rebounds	PF	Fouls
PTS	Points	ST	Steals	TO	Turnovers	TOT	Total Rebounds



Place Sidi M'Hamed  
3x3 Basketball  
Women  
Final 7th-8th Place  
Match 53



SUN 3 JUL 2022  
Start time 20:10

Results

Game Duration: 22:42

SRB 13 vs 9 SLO

Referee: Aimeur OUSSAMA (ALG)  
Umpires: Benani ANIS (ALG) Aimeur OUSSAMA (ALG)

Commissioner: Kosta ILIEV (BUL)

SRB	13
SLO	9

SRB - Serbia

No.	Name	MIN	PTS	S-EFF	1 Point		2 Points		Free Throws		Rebounds			AS	TO	ST	BS	PF	FD	+/-
					M/A	%	M/A	%	M/A	%	OR	DR	TOT							
*3	RADULOVIC Lena	6:14	3	0.30	0/5	0	1/3	33	1/2	50	1	1	1	1					1	
*9	CURAKOVIC Ivana	9:04	0	0.00	0/2	0					1	2	3					2	1	4
*22	JELIC Tijana	9:58	8	0.53	4/8	50	0/1	0	4/6	67		4	4		1	2	3	1	6	4
25	TESIC Nina	6:34	2	0.33	2/4	50	0/2	0				1	1		1	1				3
Team																				
Totals			13	0.39	6/19	32	1/6	17	5/8	63	2	7	9	1	3	3	3	3	8	

SLO - Slovenia

No.	Name	MIN	PTS	S-EFF	1 Point		2 Points		Free Throws		Rebounds			AS	TO	ST	BS	PF	FD	+/-
					M/A	%	M/A	%	M/A	%	OR	DR	TOT							
*3	SEVER Katja	9:18	1	0.25	1/3	33	0/1	0				2	2	1	1	1		3	2	-5
*5	JERAS Ana Dora	7:27	1	0.25	1/3	33			0/1	0		2	2				1			-2
*9	BURGAR Aida	8:36	4	0.67	2/4	50	1/2	50				4	4		2	1		3		-1
21	BERUS Spela	6:59	3	0.50	1/3	33	1/3	33						1		1		2	1	-4
Team																				
Totals			9	0.45	5/13	38	2/6	33	0/1	0		6	6	2	5	3	1	8	3	

	SRB	SLO
Team Fouls	3	8
Teams Fouls at 7		8:34
Teams Fouls at 10		
Technical Fouls		
Unsportsmanlike Fouls		

	SRB	SLO
Biggest lead	4	1
Biggest scoring run	5-0 (13-9)	2-0 (1-2)
Lead changes	8	

LEGEND

%	Shooting Percentage	*	Game Starters	+/-	Plus Minus	AS	Assists
BS	Blocked Shots	DR	Defensive Rebounds	EFF	Efficiency	FD	Fouls Drawn
M/A	Made/Attempts	MIN	Minutes Played	OR	Offensive Rebounds	PF	Fouls
PTS	Points	ST	Steals	TO	Turnovers	TOT	Total Rebounds



Place Sidi M'Hamed  
3x3 Basketball  
Women  
Final 9th-10th Place  
Match 42



SAT 2 JUL 2022  
Start time: 22:40

## Results

Game Duration: 23:45

### GRE 16 vs 9 ALG

Referee: RIBEIRO P. (POR)  
Umpires: Maria Giulia FORNI (ITA) RIBEIRO P. (POR)

Commissioner: Kosta ILIEV (BUL)

GRE	16
ALG	9

#### GRE - Greece

No.	Name	MIN	PTS	S-EFF	1 Point		2 Points		Free Throws		Rebounds			AS	TO	ST	BS	PF	FD	+/-
					M/A	%	M/A	%	M/A	%	OR	DR	TOT							
*4	CHATZIVASILEIOU Ioanna	7:26	2	0.20	1/4	25	0/5	0	1/1	100	2	5	7		1	1		2	3	2
5	STOUPA Nefeli Spyridoula	8:02	4	0.36	1/6	17	1/4	25	1/1	100	3	4	7	3	4				1	5
*11	KORRE Zoi	7:05	5	1.00	1/2	50	1/1	100	2/2	100		3	3		3	1		1	1	6
*13	ANASTASOPOULOU	7:28	5	0.33	1/6	17			4/9	44	1		1		2	1		1	6	8
Team																				
Totals			16	0.39	4/18	22	2/10	20	8/13	62	6	12	18	3	10	3		4	11	

#### ALG - Algeria

No.	Name	MIN	PTS	S-EFF	1 Point		2 Points		Free Throws		Rebounds			AS	TO	ST	BS	PF	FD	+/-
					M/A	%	M/A	%	M/A	%	OR	DR	TOT							
5	GRIBI Iness Fatima Zora	8:27	2	0.33	2/4	50	0/2	0			2	2	2	3	1			5		-6
*10	KETFI Kaouther	6:20	1	0.20	1/4	25	0/1	0				1	1		4	2		2		-4
*11	ALLIK Cerine	7:09	2	0.29	0/3	0	1/4	25			1	1	2			1		3		-4
*13	BELABBAS Loubna	8:01	4	0.29	3/6	50	0/6	0	1/2	50	2	4	6		1	2	1	2	4	-7
Team																				
Totals			9	0.28	6/17	35	1/13	8	1/2	50	5	6	11	3	6	5	1	12	4	

	GRE	ALG
Team Fouls	4	12
Teams Fouls at 7		5:56
Teams Fouls at 10		8:01
Technical Fouls		1
Unsportsmanlike Fouls		

	GRE	ALG
Biggest lead	7	2
Biggest scoring run	5-0 (10-5)	2-0 (1-3)
Lead changes	2	

#### LEGEND

%	Shooting Percentage	*	Game Starters	+/-	Plus Minus	AS	Assists
BS	Blocked Shots	DR	Defensive Rebounds	EFF	Efficiency	FD	Fouls Drawn
M/A	Made/Attempts	MIN	Minutes Played	OR	Offensive Rebounds	PF	Fouls
PTS	Points	ST	Steals	TO	Turnovers	TOT	Total Rebounds



ألعاب البحر الأبيض المتوسط  
MEDITERRANEAN GAMES  
JEUX MÉDITERRANÉENS  
du 25 juin au 06 juillet

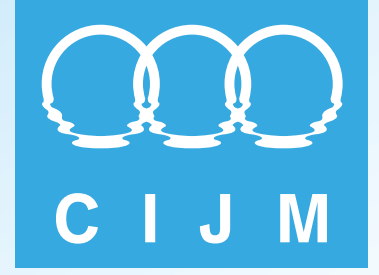

## Results Book



## Bowls



**TOSYALI  
ALGERIE**

Fer et Acier

سوناطراي



sonarach



microplus  
DATA PROCESSING & TIMING  
[www.microplustiming.com](http://www.microplustiming.com)



## Competition Schedule

As of SUN 26 JUN 2022

Date	Start Time	Event		
SUN 26 JUN 2022	10:00	Women's Pétanque Double Preliminary Poule A	Algeria (ALG) - Tunisia (TUN)	
	10:00	Women's Raffa Double Preliminary Poule A	Italy (ITA) - France (FRA)	
	10:00	Women's Raffa Double Preliminary Poule A	San Marino (SMR) - Egypt (EGY)	
	10:00	Women's Raffa Double Preliminary Poule A	Italy (ITA) - San Marino (SMR)	
	10:00	Women's Raffa Double Preliminary Poule A	Egypt (EGY) - France (FRA)	
	10:00	Women's Raffa Double Preliminary	Algeria (ALG) - Libya (LBA)	
	10:30	Women's Raffa Double Preliminary Poule B	Algeria (ALG) - Turkey (TUR)	
	16:30	Men's Raffa Single Preliminary Poule A	VISCONTI M. (ITA) - ALI H. (ALG)	
	16:30	Men's Raffa Single Preliminary Poule A	ROUAULT E. (FRA) - ALSWESI R. (LBA)	
	17:30	Men's Pétanque Double Preliminary Poule B	Spain (ESP) - Monaco (MON)	
	18:00	Women's Raffa Single Preliminary Poule A	MORELLI F. (ITA) - ELBEZ S. (LBA)	
	18:05	Men's Pétanque Double Preliminary Poule A	Algeria (ALG) - Portugal (POR)	
	18:30	Women's Pétanque Double Preliminary Poule A	Morocco (MAR) - Monaco (MON)	
	18:30	Women's Raffa Single Preliminary Poule B	AISSIOUI L. (ALG) - PAOLETTI S. (SMR)	
	18:35	Men's Pétanque Double Preliminary Poule C	France (FRA) - Tunisia (TUN)	
	19:00	Women's Pétanque Double Preliminary Poule B	Spain (ESP) - Turkey (TUR)	
	19:05	Men's Pétanque Double Preliminary Poule C	Turkiye (TUR) - Andorra (AND)	
	19:50	Women's Pétanque Double Preliminary Poule B	France (FRA) - Italy (ITA)	
	18:00	Women's Petanque Precision Round 1 Poule		
	18:00	Women's Petanque Precision Round 2 Poule		
	18:00	Women's Lyonnaise Progressive Round 1 Poule		
	18:00	Women's Lyonnaise Progressive Round 2 Poule		
	18:00	Women's Lyonnaise Precision Round 1 Poule A		
	18:00	Women's Lyonnaise Precision Round 2 Poule A		
	18:00	Men's Petanque Precision Round 1 Poule		
	18:00	Men's Petanque Precision Round 2 Poule		
	18:00	Men's Lyonnaise Progressive Round 1 Poule		
	18:00	Men's Lyonnaise Progressive Round 2 Poule		
	18:00	Men's Lyonnaise Precision Round 1 Poule A		
	18:00	Men's Lyonnaise Precision Round 2 Poule A		
	MON 27 JUN	8:30	Men's Pétanque Double Preliminary Poule A	Morocco (MAR) - Algeria (ALG)
		8:30	Men's Lyonnaise Precision Round 2 Poule A	
8:30		Men's Raffa Single Preliminary Poule A	VISCONTI M. (ITA) - ROUAULT E. (FRA)	
9:00		Men's Pétanque Double Preliminary Poule B	Spain (ESP) - Italy (ITA)	
9:00		Men's Lyonnaise Precision Round 2		
9:00		Men's Raffa Single Preliminary Poule A	ALI H. (ALG) - ALSWESI R. (LBA)	
9:30		Men's Pétanque Double Preliminary Poule C	France (FRA) - Turkiye (TUR)	
9:30		Men's Lyonnaise Precision Round 2		
9:30		Men's Raffa Single Preliminary Poule B	DALL'OLMO E. (SMR) - EMEN A. (TUR)	
10:00		Men's Pétanque Double Preliminary Poule C	Tunisia (TUN) - Andorra (AND)	



## Competition Schedule

As of SUN 26 JUN 2022

Date	Start Time	Event	
	10:00	Men's Lyonnaise Precision Round 2	
	10:10	Women's Pétanque Double Preliminary Poule A	Morocco (MAR) - Tunisia (TUN)
	10:10	Women's Pétanque Double Preliminary Poule A	Monaco (MON) - Algeria (ALG)
	10:10	Women's Pétanque Double Preliminary Poule B	France (FRA) - Spain (ESP)
	10:10	Women's Pétanque Double Preliminary Poule B	Italy (ITA) - Turkey (TUR)
	10:30	Women's Lyonnaise Precision Round 2	
	11:00	Women's Lyonnaise Precision Round 2	
	11:30	Women's Lyonnaise Precision Round 2	
	12:00	Women's Lyonnaise Precision Round 2 Poule A	
	12:00	Men's Pétanque Double Preliminary Poule A	Portugal (POR) - Morocco (MAR)
	12:00	Men's Pétanque Double Preliminary Poule B	Monaco (MON) - Italy (ITA)
	12:00	Men's Pétanque Double Preliminary Poule C	Turkiye (TUR) - Tunisia (TUN)
	15:00	Women's Pétanque Double Preliminary Poule A	Algeria (ALG) - Morocco (MAR)
	15:00	Women's Pétanque Double Preliminary Poule A	Turkey (TUR) - France (FRA)
	16:00	Men's Petanque Precision Quarter-finals	BOUGRIBA M. (TUN) - CAMPILLO G. (MON)
	16:00	Men's Petanque Precision Quarter-finals Contest 2	ESCACHO J. (ESP) - AKBAS L. (MAR)
	16:00	Men's Petanque Precision Quarter-finals Contest 3	DESPOIT L. (FRA) - OUAGHLISSI M. (ALG)
	16:00	Men's Petanque Precision Quarter-finals Contest 4	ARSLANTAS I. (TUR) - AMORMINO S. (ITA)
	16:30	Men's Petanque Precision Semi-finals Contest 1	BOUGRIBA M. (TUN) - ESCACHO J. (ESP)
	16:30	Men's Lyonnaise Progressive Quarter-finals Contest 1	CHIRAT A. (FRA) - STJEPCEVIC G. (MNE)
	17:00	Men's Petanque Precision Semi-finals Contest 2	ARSLANTAS I. (TUR) - OUAGHLISSI M. (ALG)
	17:00	Men's Lyonnaise Progressive Quarter-finals Contest 3	MILICEVIC M. (CRO) - YAKIN M. (TUR)
	17:30	Women's Lyonnaise Precision Quarter-finals Contest 1	MHAMDI Y. (TUN) - BASEI V. (ITA)
	17:30	Men's Lyonnaise Progressive Quarter-finals Contest 4	PEGORARO S. (ITA) - KHIARI H. (TUN)
	18:00	Women's Pétanque Double Preliminary Poule B	Turkey (TUR) - France (FRA)
	18:00	Women's Petanque Precision Semi-finals	BEJI M. (TUN) - GHARIZ K. (MAR)
	18:00	Women's Lyonnaise Progressive Quarter-finals Contest	GOUILLOUD P. (FRA) - VOJKOVIC R. (CRO)
	18:00	Women's Lyonnaise Precision Quarter-finals Contest 2	PETRIC T. (SLO) - LEFHAL B. (MAR)
	18:00	Women's Raffa Double Preliminary Poule A	France (FRA) - Italy (ITA)
	18:00	Women's Raffa Double Preliminary Poule B	Turkey (TUR) - Libya (LBA)
	18:00	Women's Raffa Single Preliminary Poule B	PAOLETTI S. (SMR) - TAHRAOUI M. (FRA)
	18:00	Women's Raffa Single Preliminary Poule A	CIL B. (TUR) - MORELLI F. (ITA)
	18:00	Women's Raffa Single Preliminary Poule A	ELBEZ S. (LBA) - CIL B. (TUR)
	18:00	Women's Raffa Single Preliminary Poule B	TAHRAOUI M. (FRA) - AISSIOUI L. (ALG)
	18:00	Men's Lyonnaise Progressive Quarter-finals Contest 2	ZDAUC M. (SLO) - CORLUKA A. (BIH)
	18:00	Men's Lyonnaise Precision Quarter-finals Contest 1	GRATTAPAGLIA L. (ITA) - SVARA M. (SLO)
	18:00	Men's Lyonnaise Precision Quarter-finals Contest 3	BELAY S. (FRA) - PETKOVIC M. (MNE)
	18:00	Men's Raffa Double Preliminary Poule A	Morocco (MAR) - Italy (ITA)
	18:00	Men's Raffa Double Preliminary Poule A	San Marino (SMR) - France (FRA)
	18:00	Men's Raffa Double Preliminary Poule B	Algeria (ALG) - Egypt (EGY)



## Competition Schedule

As of SUN 26 JUN 2022

Date	Start Time	Event	
	18:00	Men's Raffa Double Preliminary Poule B	Libya (LBA) - Turkiye (TUR)
	18:00	Men's Raffa Double Preliminary Poule A	San Marino (SMR) - Italy (ITA)
	18:00	Men's Raffa Double Preliminary Poule A	Morocco (MAR) - France (FRA)
	18:00	Men's Raffa Double Preliminary Poule B	Algeria (ALG) - Libya (LBA)
	18:00	Men's Raffa Double Preliminary Poule B	Egypt (EGY) - Turkiye (TUR)
	18:00	Men's Raffa Double Preliminary Poule A	France (FRA) - Italy (ITA)
	18:00	Men's Raffa Double Preliminary Poule B	Turkiye (TUR) - Algeria (ALG)
	18:00	Men's Raffa Single Preliminary Poule B	OUIAKSI Y. (MAR) - EMEN A. (TUR)
	18:00	Men's Raffa Single Preliminary Poule A	ALI H. (ALG) - ROUAULT E. (FRA)
	18:00	Men's Raffa Single Preliminary Poule B	
	18:30	Women's Petanque Precision Semi-finals	DISIDORO L. (FRA) - DIAZ REYES S. (ESP)
	18:30	Women's Lyonnaise Precision Quarter-finals Contest 3	OZTURK B. (TUR) - SOLER C. (ESP)
	18:30	Men's Lyonnaise Precision Quarter-finals Contest 2	KOVACEVIC D. (SRB) - HAMDY R. (TUN)
	18:30	Men's Lyonnaise Precision Quarter-finals Contest 4	CORLUKA A. (BIH) - BOUFATEH S. (ALG)
	19:00	Women's Lyonnaise Precision Quarter-finals Contest 4	BAJRIC C. (CRO) - GOUILLOUD P. (FRA)
	19:30	Women's Lyonnaise Progressive Quarter-finals Contest	VOLCINA N. (SLO) - AFENAI C. (ALG)
	20:00	Women's Lyonnaise Progressive Quarter-finals Contest	OZTURK I. (TUR) - BOLJEVIC N. (MNE)
TUE 28 JUN 2022	8:30	Men's Pétanque Double Quarter-finals	Algeria (ALG) - Italy (ITA)
	8:30	Men's Pétanque Double Quarter-finals Contest 4	Spain (ESP) - Tunisia (TUN)
	8:30	Men's Raffa Double Preliminary Poule A	San Marino (SMR) - Italy (ITA)
	8:30	Men's Raffa Double Preliminary Poule B	Libya (LBA) - Algeria (ALG)
	9:00	Men's Pétanque Double Quarter-finals	France (FRA) - Monaco (MON)
	9:30	Men's Pétanque Double Quarter-finals	Portugal (POR) - Morocco (MAR)
	10:00	Women's Pétanque Double Semi-finals	Tunisia (TUN) - Turkey (TUR)
	10:00	Women's Pétanque Double Semi-finals	Spain (ESP) - Algeria (ALG)
	10:00	Women's Lyonnaise Precision Semi-finals	BASEI V. (ITA) - PETRIC T. (SLO)
	10:00	Women's Raffa Double Preliminary Poule B	Algeria (ALG) - Turkey (TUR)
	10:30	Women's Lyonnaise Precision Semi-finals	OZTURK B. (TUR) - BAJRIC C. (CRO)
	10:30	Women's Raffa Double Preliminary Poule A	San Marino (SMR) - Italy (ITA)
	11:30	Men's Lyonnaise Precision Semi-finals	GRATTAPAGLIA L. (ITA) - KOVACEVIC D. (SRB)
	11:30	Men's Raffa Double Semi-finals	San Marino (SMR) - Algeria (ALG)
	12:00	Men's Lyonnaise Precision Semi-finals	BELAY S. (FRA) - BOUFATEH S. (ALG)
	12:00	Men's Raffa Double Semi-finals	Libya (LBA) - Italy (ITA)
	12:30	Men's Lyonnaise Progressive Semi-finals	MILICEVIC M. (CRO) - PEGORARO S. (ITA)
	13:00	Men's Lyonnaise Progressive Semi-finals	CHIRAT A. (FRA) - ZDAUC M. (SLO)
	15:00	Women's Lyonnaise Progressive Semi-finals	TRAVERSA S. (ITA) - VOJKOVIC R. (CRO)
	15:00	Women's Raffa Single Preliminary Poule B	PAOLETTI S. (SMR) - AISSIOUI L. (ALG)
	15:30	Women's Raffa Double Semi-finals	Algeria (ALG) - Italy (ITA)
	15:30	Women's Raffa Double Semi-finals	San Marino (SMR) - Turkey (TUR)
	15:30	Men's Pétanque Double Semi-finals	Italy (ITA) - France (FRA)



## Competition Schedule

As of SUN 26 JUN 2022

Date	Start Time	Event	
	15:30	Men's Pétanque Double Semi-finals	Morocco (MAR) - Spain (ESP)
	16:00	Women's Lyonnaise Progressive Semi-finals	VOLCINA N. (SLO) - OZTURK I. (TUR)
	16:00	Women's Raffa Single Preliminary Poule A	MORELLI F. (ITA) - CIL B. (TUR)
	16:00	Men's Raffa Single Preliminary Poule B	EMEN A. (TUR) - DALL'OLMO E. (SMR)
	16:30	Women's Pétanque Double Bronze Medal Match	Turkey (TUR) - Algeria (ALG)
	16:30	Women's Raffa Double Bronze Medal Match	Algeria (ALG) - Turkey (TUR)
	16:30	Men's Petanque Precision Bronze Medal Match	ESCACHO J. (ESP) - OUAGHLISSI M. (ALG)
	16:30	Men's Lyonnaise Progressive Bronze Medal Match	ZDAUC M. (SLO) - MILICEVIC M. (CRO)
	16:30	Men's Raffa Double Bronze Medal Match	Algeria (ALG) - Libya (LBA)
	17:00	Men's Raffa Single Preliminary Poule A	VISCONTI M. (ITA) - ROUAULT E. (FRA)
	17:30	Women's Petanque Precision Bronze Medal Match	GHARIZ K. (MAR) - DISIDORO L. (FRA)
	18:00	Women's Lyonnaise Progressive Bronze Medal Match	VOLCINA N. (SLO) - TRAVERSA S. (ITA)
	18:30	Women's Raffa Single Semi-finals	PAOLETTI S. (SMR) - CIL B. (TUR)
	19:00	Men's Raffa Single Semi-finals	ROUAULT E. (FRA) - EMEN A. (TUR)
	20:00	Women's Raffa Single Semi-finals	AISSIOUI L. (ALG) - MORELLI F. (ITA)
	20:00	Men's Raffa Single Semi-finals	DALL'OLMO E. (SMR) - VISCONTI M. (ITA)
TUE 28 JUN 2022	18:00	Women's Pétanque Double Preliminary Poule A	Tunisia (TUN) - Algeria (ALG)
	18:00	Women's Pétanque Double Preliminary Poule B	Turkey (TUR) - Spain (ESP)
WED 29 JUN 2022	8:30	Men's Raffa Single Bronze Medal Match	DALL'OLMO E. (SMR) - ROUAULT E. (FRA)
	9:00	Women's Raffa Single Bronze Medal Match	MORELLI F. (ITA) - PAOLETTI S. (SMR)
	9:00	Men's Pétanque Double Bronze Medal Match	Italy (ITA) - Spain (ESP)
	9:55	Women's Pétanque Double Gold-medal Bout	Tunisia (TUN) - Spain (ESP)
	10:00	Men's Lyonnaise Precision Bronze Medal Match	KOVACEVIC D. (SRB) - BOUFATEH S. (ALG)
	10:30	Men's Pétanque Double Gold-medal Bout	France (FRA) - Morocco (MAR)
	11:00	Women's Lyonnaise Precision Bronze Medal Match	PETRIC T. (SLO) - BAJRIC C. (CRO)
	11:30	Men's Raffa Single Gold-medal Bout	EMEN A. (TUR) - VISCONTI M. (ITA)
	15:00	Women's Petanque Precision Gold-medal Bout	BEJI M. (TUN) - DIAZ REYES S. (ESP)
	15:00	Women's Raffa Single Gold-medal Bout	AISSIOUI L. (ALG) - CIL B. (TUR)
	15:00	Men's Lyonnaise Progressive Gold-medal Bout	CHIRAT A. (FRA) - PEGORARO S. (ITA)
	15:05	Men's Petanque Precision Gold-medal Bout	BOUGRIBA M. (TUN) - ARSLANTAS I. (TUR)
	16:00	Women's Lyonnaise Progressive Gold-medal Bout	OZTURK I. (TUR) - VOJKOVIC R. (CRO)
	16:00	Men's Raffa Double Gold-medal Bout	San Marino (SMR) - Italy (ITA)
	17:00	Men's Lyonnaise Precision Gold-medal Bout	GRATTAPAGLIA L. (ITA) - BELAY S. (FRA)
	17:30	Women's Raffa Double Gold-medal Bout	Italy (ITA) - San Marino (SMR)
	18:00	Women's Lyonnaise Precision Gold-medal Bout	BASEI V. (ITA) - OZTURK B. (TUR)





## Entry List by NOC

As of TUE 5 JUL 2022

CTRY Code	Name	Date of Birth
<b>ALG</b>	<b>- Algeria</b>	
	AFENAI Celia	26 FEB 1997
	AISSIOUI Lamia	13 OCT 1980
	ALI Hakim	2 JUL 1977
	BABA ARBI Ibtissam	18 JAN 1985
	BENSLIM Mohammed	24 SEP 1989
	BOUFATEH Sid Ahmed	7 AUG 1992
	BOUGUERRA Nour El Houda	15 JAN 1999
	BOUKHEFARDJI Abdeldjalil	16 OCT 1999
	CHIBANI Chahrezad	15 APR 1980
	OUAGHLISSI Mohamed Faycal	14 JAN 1978
	TOULOUM Samia	16 JUN 1984
	ZEKIRI Tarek	2 MAR 1978
<b>AND</b>	<b>- Andorra</b>	
	BRETON MARTIN Frederic	15 MAY 1978
	FORTES PORRES Jon	26 NOV 2004
<b>BIH</b>	<b>- Bosnia and Herzegovina</b>	
	CORLUKA Andrija	3 FEB 1993
<b>CRO</b>	<b>- Croatia</b>	
	BAJRIC Carrolina	15 NOV 1999
	CUBELA Pero	5 AUG 1994
	MILICEVIC Marino	21 FEB 1992
	VOJKOVIC Ria	17 JUL 2002
<b>ESP</b>	<b>- Spain</b>	
	ANDREU QUINONES Jose Alberto	27 JUN 1999
	DIAZ REYES Sara	16 SEP 1997
	ESCACHO ALARCON Jesus Antonio	31 JUL 2001
	GUILLEN MALDONADO Daniel	4 AUG 1976
	HOMAR MAYOL Melania	19 MAY 1993
	SOLER VILCHEZ Cristina	17 JUN 1974
<b>FRA</b>	<b>- France</b>	
	BELAY Sebastien	2 AUG 1995
	CHIRAT Alexandre	18 DEC 1990
	CORBIHAN Aurelien	31 OCT 1993
	COUSIN Yohan	
	DESSPORT Lucas	11 FEB 1999
	DISIDORO Ludivine	5 FEB 1987



## Entry List by NOC

As of TUE 5 JUL 2022

CTRY Code	Name	Date of Birth
	ESTEVE Elodie	25 MAY 1998
	GOUILLOUD Pauline	7 FEB 2000
	MILLERON Mireille	1 MAR 1969
	MONTORO Ludovic	18 APR 1981
	ROUAULT Eddy	4 APR 1973
	TAHRAOUI Meriem	24 JUL 1982
<b>ITA</b>	<b>- Italy</b>	
	AMORMINO Saverio	5 APR 1997
	BASEI Valentina	25 OCT 1996
	BOTTERO Alessia	25 FEB 2000
	CHIAPELLO Andrea	8 APR 2000
	DI NICOLA Marco	13 AUG 1993
	GRATTAPAGLIA Luigi	3 OCT 1990
	MORELLI Flavia	
	PEGORARO Stefano	9 JUN 1990
	SCALISE Monica	17 APR 1984
	TRAVERSA Serena	7 OCT 1998
	TRECCANI Ilaria	14 JUL 2001
	VISCONTI Mattia	6 JUN 1997
<b>LBA</b>	<b>- Libya</b>	
	ALSWESI Rashed	30 MAY 1984
	ALZINTANI Nagah	8 APR 1985
	ELBEZ Soumaya	25 FEB 1979
	ISSA Mahmud	29 MAR 1985
<b>MAR</b>	<b>- Morocco</b>	
	AKBAS Lhousain	13 AUG 2001
	BAJJIOUI Mohamed	15 AUG 1991
	EL MOUSTAFID Abdeljalil	17 JUN 1997
	EL-GUAMOISS Mohamed	6 AUG 1973
	Ghariz Karima	14 APR 1973
	GOURAR Soukaina	14 NOV 1997
	LEFHAL EL ALAOUI Bouchra	3 MAY 1985
	QUINAKSI Yassine	22 MAY 2001
<b>MNE</b>	<b>- Montenegro</b>	
	BOLJEVIC Nina	7 JUN 1989
	PETKOVIC Miroslav	12 APR 1981
	RANKOVIC Nenad	26 MAR 1984



## Entry List by NOC

As of TUE 5 JUL 2022

CTRY Code	Name	Date of Birth
	STJEPCEVIC Gracija	8 JAN 2004
<b>MON</b>	<b>- Monaco</b>	
	CAMPILLO Claude	22 JUN 1953
	CAMPILLO Guillaume	10 SEP 1985
	CAMPILLO Sabrina	18 MAR 1983
	CROVETTO - VIALE Laurence	4 OCT 1969
<b>POR</b>	<b>- Portugal</b>	
	PERES Vitor Miguel	27 DEC 1989
	VIEGAS DAS DORES Hugo Daniel	28 JUL 1981
<b>SLO</b>	<b>- Slovenia</b>	
	PETRIC Tadeja	25 JUL 1989
	SVARA Marko	3 JAN 1987
	VOLCINA Nina	20 APR 2000
	ZDAUC Martin	26 SEP 1981
<b>SMR</b>	<b>- San Marino</b>	
	CIUCCI Anna Maria	5 JAN 1954
	DALL'OLMO Enrico	25 DEC 1995
	FRISONI Jacopo	2 FEB 1996
	PAOLETTI Stella	18 FEB 2000
<b>SRB</b>	<b>- Serbia</b>	
	KOVACEVIC Dejan	18 NOV 2000
	POPOVIC Milica	4 AUG 2001
<b>TUN</b>	<b>- Tunisia</b>	
	BEJI EP MATTOUSSI Mouna	27 JUL 1985
	BELLI Asma	22 MAY 1989
	BOUGRIBA Mohamed Khaled	30 JUL 1990
	HAMDI Rayen	5 JUN 2003
	HAMMAMI Majdi	27 JAN 1993
	KHIARI Hamza	11 MAY 1999
	MHAMDI EP JBELI Yosra	5 NOV 1983
<b>TUR</b>	<b>- Turkiye</b>	
	ALAN Murat	24 MAR 2000
	ARSLANTAS Ibrahim	18 OCT 1983
	CIL Bahar	26 MAR 1997
	DEMIR Pinar	5 SEP 1995
	EMEN Ahmet	22 JUN 1994
	ESEN Gulcin	7 APR 1980



## Entry List by NOC

As of TUE 5 JUL 2022

CTRY Code	Name	Date of Birth
	OZTURK Buket	30 DEC 2001
	OZTURK Faik Dursun	20 SEP 1992
	OZTURK Inci Ece	22 MAR 1997
	TATARLI Beyza	6 FEB 2004
	YAKIN Mehmet Can	1 FEB 1998
	YILMAZ Onur	4 JAN 1998



### Medallists by Event

As of SUN 3 JUL 2022 at 19:54

After 12 of 12 events

Event Name	Date	Medal	Name	CTRY Code
Women Lyonnaise Precision	WED 29 JUN 2022	GOLD	OZTURK Buket	TUR
		SILVER	BASEI Valentina	ITA
		BRONZE	PETRIC Tadeia	SLO
Women Lyonnaise Progressiv	WED 29 JUN 2022	GOLD	OZTURK Inci Ece	TUR
		SILVER	VOJKOVIC Ria	CRO
		BRONZE	TRAVERSA Serena	ITA
Women Petanque Precision	WED 29 JUN 2022	GOLD	BEJI EP MATTOUSSI Mouna	TUN
		SILVER	DIAZ REYES Sara	ESP
		BRONZE	GHARIZ Karima	MAR
Women Raffa Single	WED 29 JUN 2022	GOLD	CIL Bahar	TUR
		SILVER	AISSIOUI Lamia	ALG
		BRONZE	MORELLI Flavia	ITA
Men Lyonnaise Precision	WED 29 JUN 2022	GOLD	BELAY Sebastien	FRA
		SILVER	GRATTAPAGLIA Luigi	ITA
		BRONZE	KOVACEVIC Dejan	SRB
Men Lyonnaise Progressive	WED 29 JUN 2022	GOLD	CHIRAT Alexandre	FRA
		SILVER	PEGORARO Stefano	ITA
		BRONZE	MILICEVIC Marino	CRO
Men Petanque Precision	WED 29 JUN 2022	GOLD	ARSLANTAS Ibrahim	TUR
		SILVER	BOUGRIBA Mohamed Khaled	TUN
		BRONZE	OUAGHLISSI Mohamed Faycal	ALG
Men Raffa Single	WED 29 JUN 2022	GOLD	VISCONTI Mattia	ITA
		SILVER	EMEN Ahmet	TUR
		BRONZE	DALL'OLMO Enrico	SMR
Women Pétanque Double	WED 29 JUN 2022	GOLD	BEJI EP MATTOUSSI Mouna BELLI Asma	TUN TUN
		SILVER	DIAZ REYES Sara HOMAR MAYOL Melania	ESP ESP
		BRONZE	ESEN Gulcin TATARLI Beyza	TUR TUR
Women Raffa Double	WED 29 JUN 2022	GOLD	CIUCCI Anna Maria PAOLETTI Stella	SMR SMR
		SILVER	MORELLI Flavia TRECCANI Ilaria	ITA ITA
		BRONZE	AISSIOUI Lamia CHIBANI Chahrezad	ALG ALG
Men Pétanque Double	WED 29 JUN 2022	GOLD	COUSIN Yohan DESPOINT Lucas	FRA FRA
		SILVER	AKBAS Lhoussain BAJJIQUI Mohamed	MAR MAR
		BRONZE	AMORMINO Saverio CHIAPELLO Andrea	ITA ITA



## Medallists by Event

As of SUN 3 JUL 2022 at 19:54

After 12 of 12 events

Event Name	Date	Medal	Name	CTRY Code
Men Raffa Double	WED 29 JUN 2022	GOLD	DI NICOLA Marco VISCONTI Mattia	ITA ITA
		SILVER	DALL'OLMO Enrico FRISONI Jacopo	SMR SMR
		BRONZE	ALSWESI Rashed ISSA Mahmud	LBA LBA



## Medal Standings

As of SUN 3 JUL 2022 at 19:54  
After 8 of 8 events

Rank	Country	Men				Women				Total				Rank by total
		G	S	B	Tot	G	S	B	Tot	G	S	B	Tot	
1	TUR - Turkiye	1	1		2	3		1	4	4	1	1	6	2
2	FRA - France	3			3					3			3	=3
3	ITA - Italy	2	2	1	5		2	2	4	2	4	3	9	1
4	TUN - Tunisia		1		1	2			2	2	1		3	=3
5	SMR - San Marino		1	1	2	1			1	1	1	1	3	=3
6	ESP - Spain						2		2		2		2	=7
7	ALG - Algeria			1	1		1	1	2		1	2	3	=3
8	CRO - Croatia			1	1		1		1		1	1	2	=7
8	MAR - Morocco		1		1			1	1		1	1	2	=7
10	LBA - Libya			1	1							1	1	=10
10	SLO - Slovenia							1	1			1	1	=10
10	SRB - Serbia			1	1							1	1	=10
	<b>Total:</b>	<b>6</b>	<b>6</b>	<b>6</b>	<b>18</b>	<b>6</b>	<b>6</b>	<b>6</b>	<b>18</b>	<b>12</b>	<b>12</b>	<b>12</b>	<b>36</b>	

LEGEND

- -  
- -



## Entry List by Event

CTRY	Name	Date of Birth
ALG - Algeria	BOUKHEFARDJI Abdeldjalil	16 OCT 1999
	OUAGHLISSI Mohamed Faycal	14 JAN 1978
AND - Andorra	BRETON MARTIN Frederic	15 MAY 1978
	FORTES PORRES Jon	26 NOV 2004
ESP - Spain	ANDREU QUINONES Jose Alberto	27 JUN 1999
	ESCACHO ALARCON Jesus Antonio	31 JUL 2001
FRA - France	DESPORT Lucas	11 FEB 1999
	MONTORO Ludovic	18 APR 1981
ITA - Italy	AMORMINO Saverio	5 APR 1997
MAR - Morocco	AKBAS Lhoussein	13 AUG 2001
MNE - Montenegro	RANKOVIC Nenad	26 MAR 1984
MON - Monaco	CAMPILLO Guillaume	10 SEP 1985
POR - Portugal	VIEGAS DAS DORES Hugo Daniel	28 JUL 1981
	PERES Vitor Miguel	27 DEC 1989
TUN - Tunisia	BOUGRIBA Mohamed Khaled	30 JUL 1990
	HAMMAMI Majdi	27 JAN 1993
TUR - Turkiye	ARSLANTAS Ibrahim	18 OCT 1983
	YILMAZ Onur	4 JAN 1998

Total number of athletes: 18





## Results

Rank	Name	CTRY	Round 1	Round 2	Total	Remarks
1	BOUGRIBA Mohamed Khaled	TUN	46	0	46	Q
2	DESSPORT Lucas	FRA	40	0	40	Q
3	ARSLANTAS Ibrahim	TUR	39	0	39	Q
4	ESCACHO ALARCON Jesus Antonio	ESP	38	0	38	Q
5	AKBAS Lhoussain	MAR	34	0	34	
6	AMORMINO Saverio	ITA	30	0	30	
7	FORTES PORRES Jon	AND	28	0	28	
8	OUAGHLISSI Mohamed Faycal	ALG	23	0	23	
9	CAMPILLO Guillaume	MON	22	0	22	
10	VIEGAS DAS DORES Hugo Daniel	POR	19	0	19	

### LEGEND

<b>DIS</b>	Disqualified	<b>ELI</b>	Eliminated	<b>ACC</b>	Injured	<b>RET</b>	Retired
<b>T</b>	Two or more players share the same	<b>WD</b>	WithDrawn				



## Results

Rank	Name	CTRY	Round 1	Round 2	Total	Remarks
1	BOUGRIBA Mohamed Khaled	TUN	46	0	46	Q
2	DESSPORT Lucas	FRA	40	0	40	Q
3	ARSLANTAS Ibrahim	TUR	39	0	39	Q
4	ESCACHO ALARCON Jesus Antonio	ESP	38	0	38	Q
5	AKBAS Lhoussain	MAR	34	41	75	Q
6	AMORMINO Saverio	ITA	30	41	71	Q
7	OUAGHLISSI Mohamed Faycal	ALG	23	36	59	Q
8	CAMPILLO Guillaume	MON	22	35	57	Q
9	FORTES PORRES Jon	AND	28	28	56	
10	VIEGAS DAS DORES Hugo Daniel	POR	19	33	52	

### LEGEND

<b>DIS</b>	Disqualified	<b>ELI</b>	Eliminated	<b>ACC</b>	Injured	<b>RET</b>	Retired
<b>T</b>	Two or more players share the same	<b>WD</b>	WithDrawn				



## Results Summary

As of WED 29 JUN 2022 at 15:45

Match	Name	CTRY	Result	CTRY	Name
<b>MON 27 JUN 2022</b>					
Quarter-finals	BOUGRIBA Mohamed Khaled	TUN	34 - 21	MON	CAMPILLO Guillaume
Quarter-finals Contest 2	ESCACHO ALARCON Jesus Antonio	ESP	41 - 32	MAR	AKBAS Lhoussain
Quarter-finals Contest 3	DESSPORT Lucas	FRA	40 - 43	ALG	OUAGHLISSI Mohamed Faycal
Quarter-finals Contest 4	ARSLANTAS Ibrahim	TUR	34 - 21	ITA	AMORMINO Saverio
Semi-finals Contest 1	BOUGRIBA Mohamed Khaled	TUN	44 - 34	ESP	ESCACHO ALARCON Jesus Antonio
Semi-finals Contest 2	ARSLANTAS Ibrahim	TUR	30 - 25	ALG	OUAGHLISSI Mohamed Faycal
<b>TUE 28 JUN 2022</b>					
Bronze Medal Match	ESCACHO ALARCON Jesus Antonio	ESP	21 - 40	ALG	OUAGHLISSI Mohamed Faycal
<b>WED 29 JUN 2022</b>					
Gold-medal Bout	BOUGRIBA Mohamed Khaled	TUN	29 - 31	TUR	ARSLANTAS Ibrahim

### LEGEND

DIS Disqualified      ELI Eliminated      ACC Injured      RET Retired  
T Two or more players share the same r      WD WithDrawn



## Draw Sheet

As of WED 29 JUN 2022 at 15:44

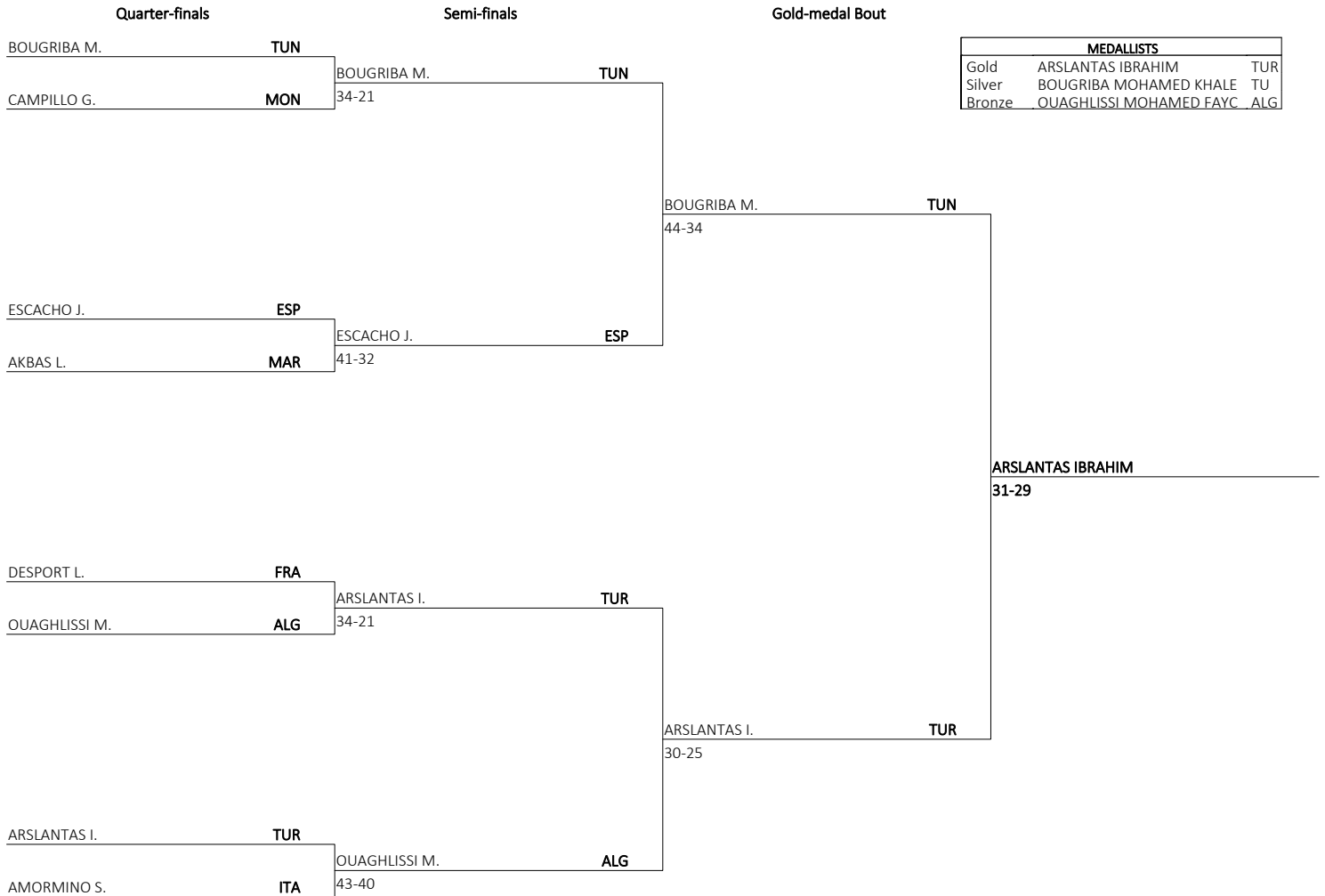

MEDALLISTS		
Gold	ARSLANTAS IBRAHIM	TUR
Silver	BOUGRIBA MOHAMED KHALE	TU
Bronze	OUAGHLISSI MOHAMED FAYC	ALG



## Draw Sheet

As of WED 29 JUN 2022 at 15:44

Bronze Medal Match

ESCACHO J.	ESP
OUAGHLISSI M.	ALG
OUAGHLISSI MOHAMED FAYCAL	
40-21	



## Medallists

As of MON 4 JUL 2022 at 10:40

Medal	Name	CTRY
GOLD	ARSLANTAS Ibrahim	TUR - Turkiye
SILVER	BOUGRIBA Mohamed Khaled	TUN - Tunisia
BRONZE	OUAGHLISSI Mohamed Faycal	ALG - Algeria



## Entry List by Event

CTRY	Name	Date of Birth
ALG - Algeria	BOUKHEFARDJI Abdeldjalil	16 OCT 1999
	OUAGHLISSI Mohamed Faycal	14 JAN 1978
AND - Andorra	BRETON MARTIN Frederic	15 MAY 1978
	FORTES PORRES Jon	26 NOV 2004
ESP - Spain	ANDREU QUINONES Jose Alberto	27 JUN 1999
	ESCACHO ALARCON Jesus Antonio	31 JUL 2001
FRA - France	COUSIN Yohan	
	DESPORT Lucas	11 FEB 1999
ITA - Italy	AMORMINO Saverio	5 APR 1997
	CHIAPELLO Andrea	8 APR 2000
MAR - Morocco	BAJIOUI Mohamed	15 AUG 1991
	AKBAS Lhoussain	13 AUG 2001
MNE - Montenegro	PETKOVIC Miroslav	12 APR 1981
	RANKOVIC Nenad	26 MAR 1984
MON - Monaco	CAMPILLO Claude	22 JUN 1953
	CAMPILLO Guillaume	10 SEP 1985
POR - Portugal	VIEGAS DAS DORES Hugo Daniel	28 JUL 1981
	PERES Vitor Miguel	27 DEC 1989
TUN - Tunisia	BOUGRIBA Mohamed Khaled	30 JUL 1990
	HAMMAMI Majdi	27 JAN 1993
TUR - Turkiye	ARSLANTAS Ibrahim	18 OCT 1983
	YILMAZ Onur	4 JAN 1998

Total number of athletes: 22



## Group Play Summary

As of TUE 5 JUL 2022 at 15:05

Poule A						Matches			Remarks
Rank			A	B	C	Played	Won	Lost	
1	A	Algeria	---	9-4	12-5	2	2	0	
2	B	Portugal	4-9	---	7-11	2	0	2	
	C	Morocco	5-12	11-7	---	0	0	0	

Poule B						Matches			Remarks
Rank			A	B	C	Played	Won	Lost	
1	A	Spain	---	13-1	10-3	2	2	0	
2	B	Monaco	1-13	---	12-13	2	0	2	
	C	Italy	3-10	13-12	---	0	0	0	

Poule C						Matches			Remarks
Rank			A	B	C	D	Played	Won	
1	A	France	---	12-3	15-4		2	2	0
2	B	Tunisia	3-12	---	13-12	10-5	3	2	1
3	C	Turkiye	4-15	12-13	---	12-11	3	1	2
4	D	Andorra		5-10	11-12	---	2	0	2





## Results Summary

As of TUE 5 JUL 2022 at 19:16

Match	Name	CTRY	Result	CTRY	Name
<b>SUN 26 JUN 2022</b>					
Poule A Match 1	ALGERIA	ALG	9 - 4	POR	PORTUGAL
Poule B Match 1	SPAIN	ESP	13 - 1	MON	MONACO
Poule C Match 1	FRANCE	FRA	12 - 3	TUN	TUNISIA
Poule C Match 2	TURKIYE	TUR	12 - 11	AND	ANDORRA
<b>MON 27 JUN 2022</b>					
Poule A Match 3	MOROCCO	MAR	5 - 12	ALG	ALGERIA
Poule B Match 3	SPAIN	ESP	10 - 3	ITA	ITALY
Poule C Match 3	FRANCE	FRA	15 - 4	TUR	TURKIYE
Poule C Match 4	TUNISIA	TUN	10 - 5	AND	ANDORRA
Poule C Match 5	TURKIYE	TUR	12 - 13	TUN	TUNISIA
Poule A Match 5	PORTUGAL	POR	7 - 11	MAR	MOROCCO
Poule B Match 5	MONACO	MON	12 - 13	ITA	ITALY
Poule A Match 6	MOROCCO	MAR	18:00		
Poule B Match 6	ITALY	ITA	18:00		
Poule C Match 6	ANDORRA	AND	18:00		
<b>TUE 28 JUN 2022</b>					
Quarter-finals	ALGERIA	ALG	5 - 13	ITA	ITALY
Quarter-finals Contest 4	SPAIN	ESP	13 - 11	TUN	TUNISIA
Quarter-finals	FRANCE	FRA	13 - 0	MON	MONACO
Quarter-finals	PORTUGAL	POR	4 - 13	MAR	MOROCCO
Semi-finals	ITALY	ITA	9 - 13	FRA	FRANCE
Semi-finals	MOROCCO	MAR	13 - 4	ESP	SPAIN
<b>WED 29 JUN 2022</b>					
Bronze Medal Match	ITALY	ITA	13 - 11	ESP	SPAIN
Gold-medal Bout	FRANCE	FRA	13 - 5	MAR	MOROCCO

### LEGEND

DIS	Disqualified	ELI	Eliminated	ACC	Injured	RET	Retired
T	Two or more players share the same	WD	WithDrawn				



## Draw Sheet

As of TUE 28 JUN 2022 at 08:08

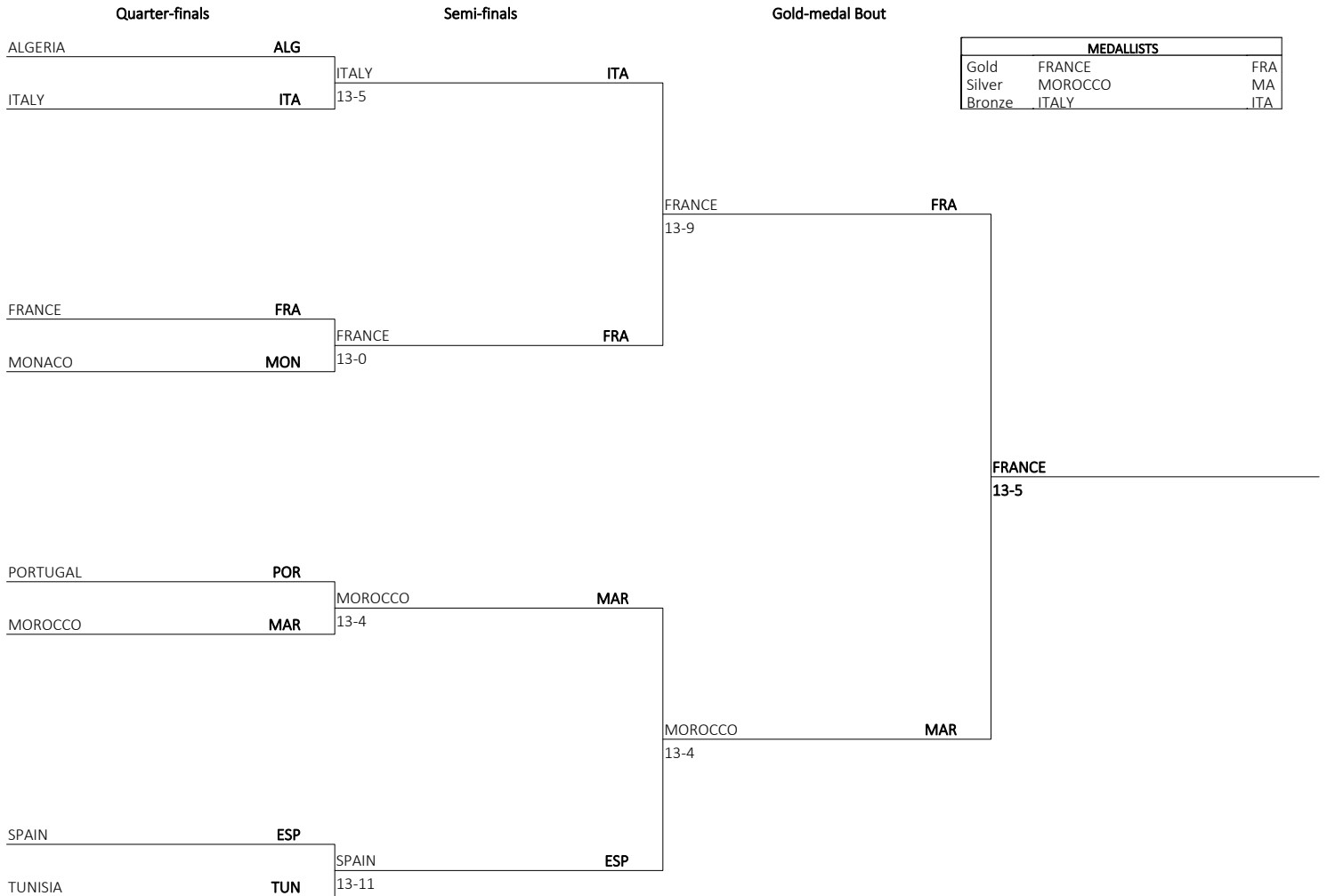



## Draw Sheet

As of TUE 28 JUN 2022 at 08:08

Bronze Medal Match

ITALY	ITA	
		ITALY 13-11
SPAIN	ESP	



## Medallists

Medal	CTRY	Name
GOLD	FRA - France	COUSIN Yohan DESSPORT Lucas
SILVER	MAR - Morocco	AKBAS Lhossain BAJJIOUI Mohamed
BRONZE	ITA - Italy	AMORMINO Saverio CHIAPELLO Andrea



## Entry List by Event

CTRY	Name	Date of Birth
ALG - Algeria	BOUFATEH Sid Ahmed	7 AUG 1992
BIH - Bosnia and Herzegovina	CORLUKA Andrija	3 FEB 1993
CRO - Croatia	CUBELA Pero	5 AUG 1994
ESP - Spain	GUILLEN MALDONADO Daniel	4 AUG 1976
FRA - France	BELAY Sebastien	2 AUG 1995
ITA - Italy	GRATTAPAGLIA Luigi	3 OCT 1990
MAR - Morocco	EL-GUAMOISS Mohamed	6 AUG 1973
MNE - Montenegro	PETKOVIC Miroslav	12 APR 1981
SLO - Slovenia	SVARA Marko	3 JAN 1987
SRB - Serbia	KOVACEVIC Dejan	18 NOV 2000
TUN - Tunisia	HAMDY Rayen	5 JUN 2003
TUR - Turkiye	OZTURK Faik Dursun	20 SEP 1992

Total number of athletes: 12



## Results

Rank	Name	CTRY	Round 1	Round 2	Total	Remarks
1	KOVACEVIC Dejan	SRB	23	0	23	
2	GRATTAPAGLIA Luigi	ITA	21	0	21	
2	BELAY Sebastien	FRA	21	0	21	
4	SVARA Marko	SLO	20	0	20	
5	CORLUKA Andrija	BIH	19	0	19	
6	BOUFATEH Sid Ahmed	ALG	14	0	14	
7	CUBELA Pero	CRO	11	0	11	
8	HAMDI Rayen	TUN	9	0	9	
9	OZTURK Faik Dursun	TUR	8	0	8	
10	EL-GUAMOISS Mohamed	MAR	7	0	7	
11	PETKOVIC Miroslav	MNE	5	0	5	

### LEGEND

DIS	Disqualified	ELI	Eliminated	ACC	Injured	RET	Retired
T	Two or more players share the same r	WD	WithDrawn				



## Results

Rank	Name	CTRY	Round 1	Round 2	Total	Remarks
1	BELAY Sebastien	FRA	21	30	51	Q
2	KOVACEVIC Dejan	SRB	23	22	45	Q
3	GRATTAPAGLIA Luigi	ITA	21	20	41	Q
4	SVARA Marko	SLO	20	10	30	Q
5	CORLUKA Andrija	BIH	19	19	38	Q
6	BOUFATEH Sid Ahmed	ALG	14	18	32	Q
7	HAMDI Rayen	TUN	9	17	26	Q
8	PETKOVIC Miroslav	MNE	5	19	24	Q
9	CUBELA Pero	CRO	11	9	20	
10	EL-GUAMOISS Mohamed	MAR	7	12	19	
11	OZTURK Faik Dursun	TUR	8	10	18	
12	GUILLEN MALDONADO Daniel	ESP	3	11	14	

### LEGEND

<b>DIS</b>	Disqualified	<b>ELI</b>	Eliminated	<b>ACC</b>	Injured	<b>RET</b>	Retired
<b>T</b>	Two or more players share the same	<b>WD</b>	WithDrawn				



## Results Summary

As of WED 29 JUN 2022 at 10:21

Match	Name	CTRY	Result	CTRY	Name
<b>SAT 30 DEC 1899</b>					
Quarter-finals Contest 1	GRATTAPAGLIA Luigi	ITA	24 - 15	SLO	SVARA Marko
Quarter-finals Contest 2	KOVACEVIC Dejan	SRB	13 - 4	TUN	HAMDI Rayen
Quarter-finals Contest 3	BELAY Sebastien	FRA	24 - 11	MNE	PETKOVIC Miroslav
Quarter-finals Contest 4	CORLUKA Andrija	BIH	6 - 15	ALG	BOUFATEH Sid Ahmed
<b>TUE 28 JUN 2022</b>					
Semi-finals	GRATTAPAGLIA Luigi	ITA	23 - 12	SRB	KOVACEVIC Dejan
Semi-finals	BELAY Sebastien	FRA	26 - 17	ALG	BOUFATEH Sid Ahmed
<b>WED 29 JUN 2022</b>					
Bronze Medal Match	KOVACEVIC Dejan	SRB	11 - 8	ALG	BOUFATEH Sid Ahmed
Gold-medal Bout	GRATTAPAGLIA Luigi	ITA	17:00	FRA	BELAY Sebastien

### LEGEND

DIS Disqualified      ELI Eliminated      ACC Injured      RET Retired  
T Two or more players share the same r      WD WithDrawn





## Draw Sheet

As of WED 29 JUN 2022 at 17:18

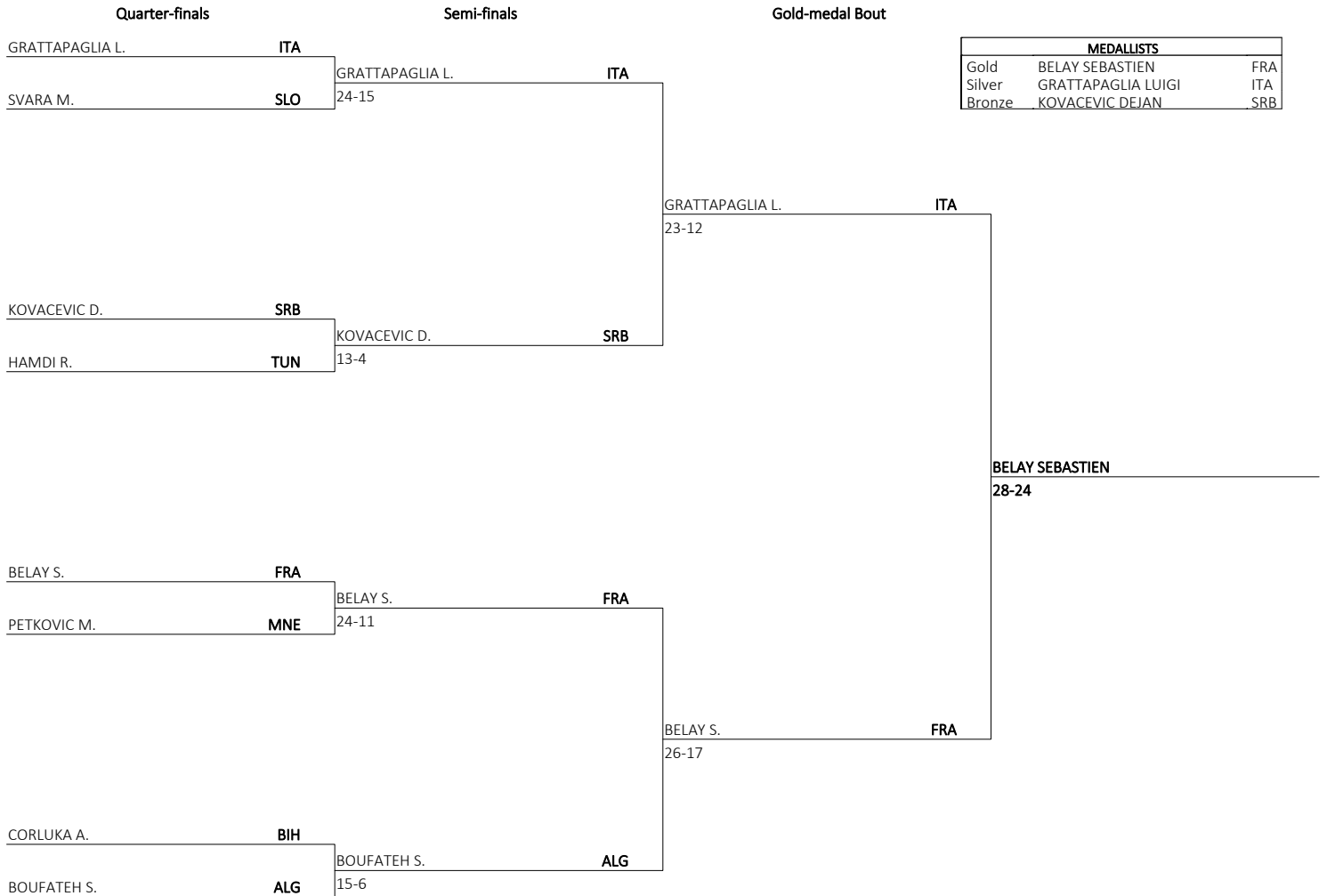

MEDALLISTS		
Gold	BELAY SEBASTIEN	FRA
Silver	GRATTAPAGLIA LUIGI	ITA
Bronze	KOVACEVIC DEJAN	SRB



## Draw Sheet

As of WED 29 JUN 2022 at 17:18

Bronze Medal Match

KOVACEVIC D.	SRB	
		KOVACEVIC DEJAN
		11-8
BOUFATEH S.	ALG	



## Medallists

As of MON 4 JUL 2022 at 10:41

Medal	Name	CTRY
GOLD	BELAY Sebastien	FRA - France
SILVER	GRATTAPAGLIA Luigi	ITA - Italy
BRONZE	KOVACEVIC Dejan	SRB - Serbia



## Entry List by Event

CTRY	Name	Date of Birth
ALG - Algeria	BENSLIM Mohammed	24 SEP 1989
BIH - Bosnia and Herzegovina	CORLUKA Andrija	3 FEB 1993
CRO - Croatia	MILICEVIC Marino	21 FEB 1992
FRA - France	CHIRAT Alexandre	18 DEC 1990
ITA - Italy	PEGORARO Stefano	9 JUN 1990
MNE - Montenegro	STJEPCEVIC Gracija	8 JAN 2004
SLO - Slovenia	ZDAUC Martin	26 SEP 1981
TUN - Tunisia	KHIARI Hamza	11 MAY 1999
TUR - Turkiye	YAKIN Mehmet Can	1 FEB 1998

Total number of athletes: 9



## Results

Rank	Name	CTRY	Round 1	Round 2	Total
1	ZDAUC Martin	SLO	45	0	45
2	CHIRAT Alexandre	FRA	44	0	44
3	PEGORARO Stefano	ITA	43	0	43
4	YAKIN Mehmet Can	TUR	40	0	40
4	STJEPCEVIC Gracija	MNE	40	0	40
6	MILICEVIC Marino	CRO	37	0	37
7	CORLUKA Andrija	BIH	36	0	36
8	KHIARI Hamza	TUN	35	0	35
8	BENSLIM Mohammed	ALG	35	0	35

### LEGEND

<b>DIS</b>	Disqualified	<b>ELI</b>	Eliminated	<b>ACC</b>	Injured	<b>RET</b>	Retired
<b>T</b>	Two or more players share the same	<b>WD</b>	WithDrawn				



## Results

Rank	Name	CTRY	Round 1	Round 2	Total	Remarks
1	ZDAUC Martin	SLO	45	45	90	
2	PEGORARO Stefano	ITA	43	48	91	
3	CHIRAT Alexandre	FRA	44	45	89	
4	YAKIN Mehmet Can	TUR	40	42	82	
5	STJEPCEVIC Gracija	MNE	40	38	78	
6	MILICEVIC Marino	CRO	37	45	82	
7	CORLUKA Andrija	BIH	36	41	77	
8	KHIARI Hamza	TUN	35	41	76	
9	BENSLIM Mohammed	ALG	35	31	66	

### LEGEND

DIS	Disqualified	ELI	Eliminated	ACC	Injured	RET	Retired
T	Two or more players share the same r		WD	WithDrawn			



## Results Summary

As of WED 29 JUN 2022 at 16:40

Match	Name	CTRY	Result	CTRY	Name
<b>MON 27 JUN 2022</b>					
Quarter-finals Contest 1	CHIRAT Alexandre	FRA	46 - 42	MNE	STJEPCEVIC Gracija
Quarter-finals Contest 3	MILICEVIC Marino	CRO	48 - 42	TUR	YAKIN Mehmet Can
Quarter-finals Contest 4	PEGORARO Stefano	ITA	47 - 38	TUN	KHIARI Hamza
Quarter-finals Contest 2	ZDAUC Martin	SLO	39 - 39	BIH	CORLUKA Andrija
<b>TUE 28 JUN 2022</b>					
Semi-finals	MILICEVIC Marino	CRO	41 - 48	ITA	PEGORARO Stefano
Semi-finals	CHIRAT Alexandre	FRA	45 - 43	SLO	ZDAUC Martin
Bronze Medal Match	ZDAUC Martin	SLO	35 - 44	CRO	MILICEVIC Marino
<b>WED 29 JUN 2022</b>					
Gold-medal Bout	CHIRAT Alexandre	FRA	46 - 45	ITA	PEGORARO Stefano

### LEGEND

DIS Disqualified      ELI Eliminated      ACC Injured      RET Retired  
T Two or more players share the same r      WD WithDrawn



## Draw Sheet

As of WED 29 JUN 2022 at 16:40

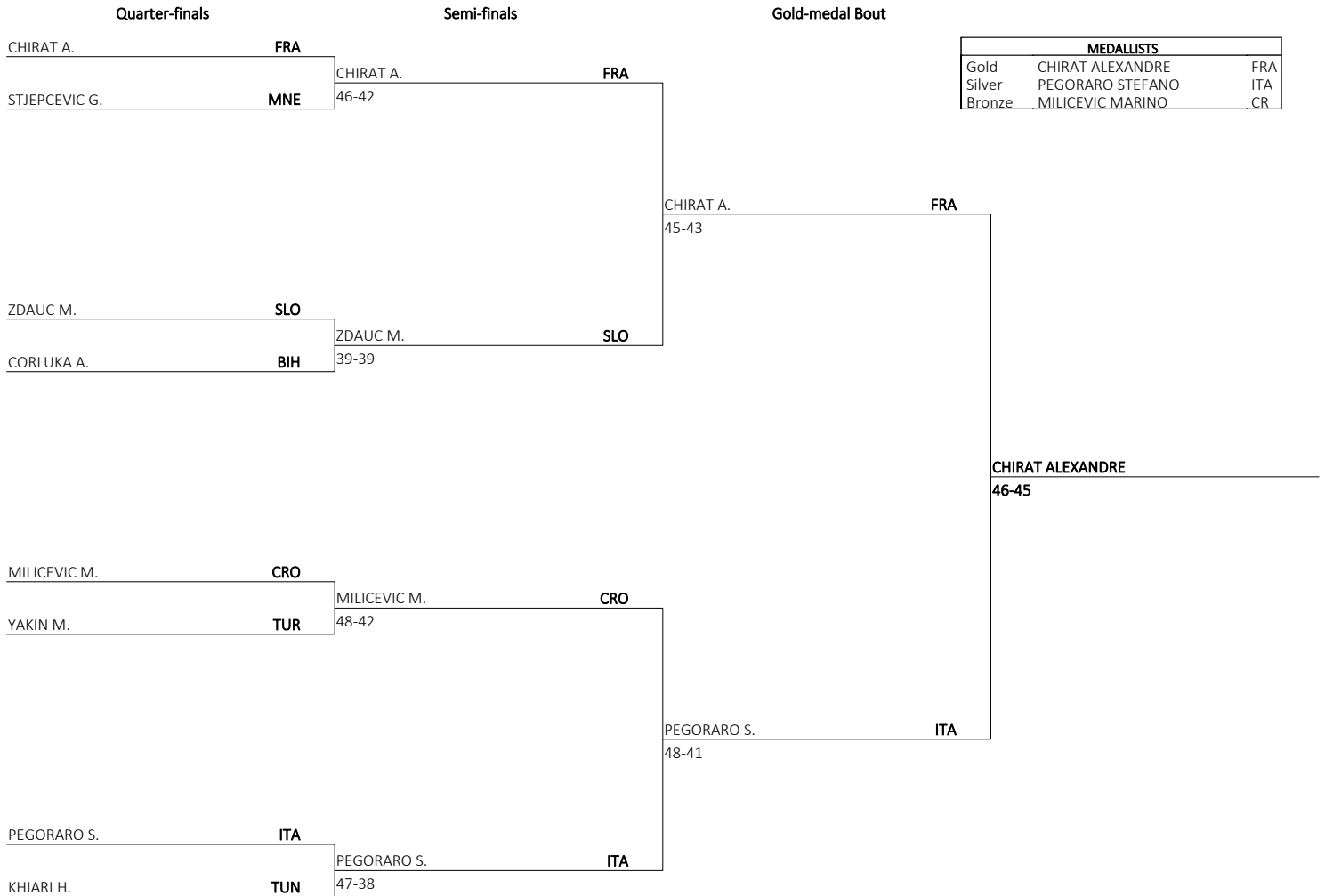





## Draw Sheet

As of WED 29 JUN 2022 at 16:40

Bronze Medal Match

ZDAUC M.	SLO	
		MILICEVIC MARINO
		44-35
MILICEVIC M.	CRO	



## Medallists

As of MON 4 JUL 2022 at 10:40

Medal	Name	CTRY
GOLD	CHIRAT Alexandre	FRA - France
SILVER	PEGORARO Stefano	ITA - Italy
BRONZE	MILICEVIC Marino	CRO - Croatia



## Entry List by Event

CTRY	Name	Date of Birth
ALG - Algeria	ALI Hakim	2 JUL 1977
FRA - France	ROUAULT Eddy	4 APR 1973
ITA - Italy	VISCONTI Mattia	6 JUN 1997
LBA - Libya	ALSWESI Rashed	30 MAY 1984
MAR - Morocco	OUIAKSI Yassine	22 MAY 2001
MNE - Montenegro	RANKOVIC Nenad	26 MAR 1984
SMR - San Marino	DALL'OLMO Enrico	25 DEC 1995
TUR - Turkiye	EMEN Ahmet	22 JUN 1994

Total number of athletes: 8



## Group Play Summary

As of TUE 5 JUL 2022 at 15:07

Poule A							Matches			Remarks
Rank			A	B	C	D	Played	Won	Lost	
1	A	VISCONTI M. (ITA)	---	12-6 / 12-8		12-6	3	3	0	
2	B	ROUAULT E. (FRA)	6-12 / 8-12	---	12-10	12-9	4	2	2	
3	C	ALSWESI R. (LBA)		10-12	---	0-0	2	0	1	
4	D	ALI H. (ALG)	6-12	9-12	0-0	---	3	0	2	

Poule B							Matches			Remarks
Rank			A	B	C		Played	Won	Lost	
1	A	EMEN A. (TUR)	---	12-8	0-0 / 12-11		3	2	0	
2	B	OUIAKSI Y. (MAR)	8-12	---			1	0	1	
3	C	DALL'OLMO E. (SMR)	0-0 / 11-12		---		2	0	1	



## Results Summary

As of TUE 5 JUL 2022 at 19:05

Match	Name	CTRY	Result	CTRY	Name
<b>SAT 30 DEC 1899</b>					
Poule B Match 1	DALL'OLMO Enrico	SMR	00:00		
<b>SUN 26 JUN 2022</b>					
Poule A Match 1	VISCONTI Mattia	ITA	12 - 6	ALG	ALI Hakim
Poule A Match 2	ROUAULT Eddy	FRA	12 - 10	LBA	ALSWESI Rashed
<b>MON 27 JUN 2022</b>					
Poule A Match 3	VISCONTI Mattia	ITA	12 - 6	FRA	ROUAULT Eddy
Poule A Match 4	ALI Hakim	ALG	0 - 0	LBA	ALSWESI Rashed
Poule B Match 3	DALL'OLMO Enrico	SMR	0 - 0	TUR	EMEN Ahmet
Poule B Match 2	OUIAKSI Yassine	MAR	8 - 12	TUR	EMEN Ahmet
Poule A Match 5	ALI Hakim	ALG	9 - 12	FRA	ROUAULT Eddy
<b>TUE 28 JUN 2022</b>					
Semi-finals	ROUAULT Eddy	FRA	11 - 12	TUR	EMEN Ahmet
Semi-finals	DALL'OLMO Enrico	SMR	8 - 12	ITA	VISCONTI Mattia
Poule B Match 6	EMEN Ahmet	TUR	12 - 11	SMR	DALL'OLMO Enrico
Poule A Match 6	VISCONTI Mattia	ITA	12 - 8	FRA	ROUAULT Eddy
<b>WED 29 JUN 2022</b>					
Bronze Medal Match	DALL'OLMO Enrico	SMR	12 - 10	FRA	ROUAULT Eddy
Gold-medal Bout	EMEN Ahmet	TUR	2 - 12	ITA	VISCONTI Mattia

### LEGEND

DIS	Disqualified	ELI	Eliminated	ACC	Injured	RET	Retired
T	Two or more players share the same	WD	WithDrawn				



## Draw Sheet

As of TUE 5 JUL 2022 at 19:04

Semi-finals

Gold-medal Bout

MEDALLISTS		
Gold	VISCONTI MATTIA	ITA
Silver	EMEN AHMET	TUR
Bronze	DALL'OLMO ENRICO	SMR

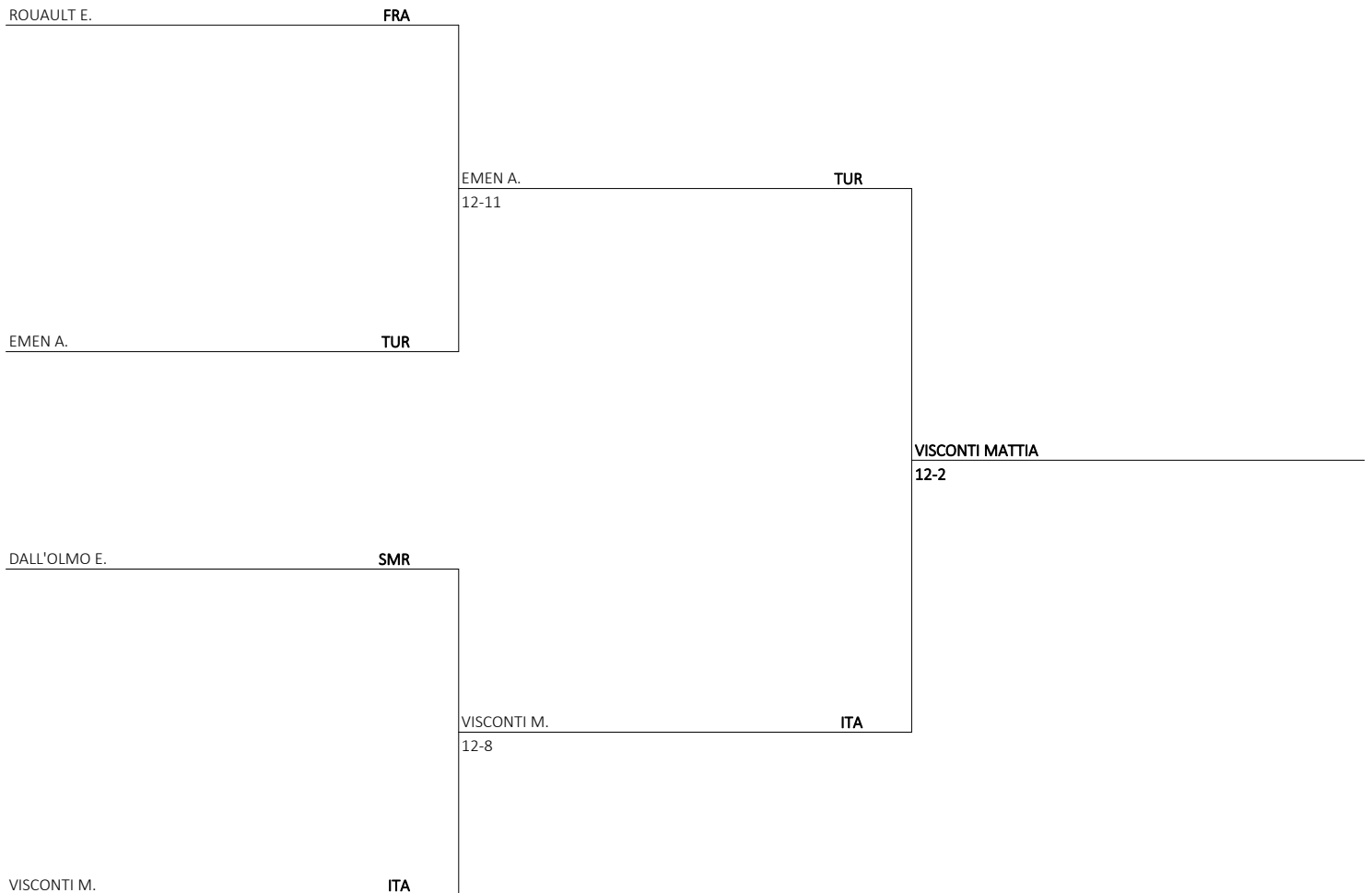



## Draw Sheet

As of TUE 5 JUL 2022 at 19:04

Bronze Medal Match

DALL'OLMO E.

SMR

DALL'OLMO ENRICO

12-10

ROUAULT E.

FRA



## Medallists

As of MON 4 JUL 2022 at 10:42

Medal	Name	CTRY
GOLD	VISCONTI Mattia	ITA - Italy
SILVER	EMEN Ahmet	TUR - Turkiye
BRONZE	DALL'OLMO Enrico	SMR - San Marino





## Entry List by Event

CTRY	Name	Date of Birth
ALG - Algeria	ZEKIRI Tarek	2 MAR 1978
	ALI Hakim	2 JUL 1977
FRA - France	ROUAULT Eddy	4 APR 1973
	CORBIHAN Aurelien	31 OCT 1993
ITA - Italy	VISCONTI Mattia	6 JUN 1997
	DI NICOLA Marco	13 AUG 1993
LBA - Libya	ALSWESI Rashed	30 MAY 1984
	ISSA Mahmud	29 MAR 1985
MAR - Morocco	EL MOUSTAFID Abdeljalil	17 JUN 1997
	OUINAKSI Yassine	22 MAY 2001
MNE - Montenegro	STJEPCEVIC Gracija	8 JAN 2004
	RANKOVIC Nenad	26 MAR 1984
SMR - San Marino	DALL'OLMO Enrico	25 DEC 1995
	FRISONI Jacopo	2 FEB 1996
TUR - Turkiye	EMEN Ahmet	22 JUN 1994
	ALAN Murat	24 MAR 2000

Total number of athletes: 16



## Group Play Summary

As of TUE 5 JUL 2022 at 15:06

Poule A							Matches			Remarks
Rank			A	B	C	D	Played	Won	Lost	
1	A	San Marino	---	12-9	12-6 / 12-6		3	3	0	
2	B	France	9-12	---	8-12	12-0	3	1	2	
3	C	Italy	6-12 / 6-12	12-8	---	0-0	4	1	2	
4	D	Morocco		0-12	0-0	---	2	0	1	

Poule B							Matches			Remarks
Rank			A	B	C	D	Played	Won	Lost	
1	A	Algeria	---	12-10	8-12 / 12-1	12-0	4	3	1	
2	B	Turkiye	10-12	---	0-0	12-0	3	1	1	
3	C	Libya	12-8 / 1-12	0-0	---		3	1	1	
4	D	Egypt	0-12	0-12		---	2	0	2	



## Results Summary

As of TUE 5 JUL 2022 at 19:19

Match	Name	CTRY	Result	CTRY	Name
<b>MON 27 JUN 2022</b>					
Poule A Match 1	MOROCCO	MAR	0 - 0	ITA	ITALY
Poule A Match 2	SAN MARINO	SMR	12 - 9	FRA	FRANCE
Poule B Match 2	LIBYA	LBA	0 - 0	TUR	TURKIYE
Poule B Match 1	ALGERIA	ALG	12 - 0	EGY	EGYPT
Poule A Match 3	SAN MARINO	SMR	12 - 6	ITA	ITALY
Poule B Match 3	ALGERIA	ALG	8 - 12	LBA	LIBYA
Poule A Match 4	MOROCCO	MAR	0 - 12	FRA	FRANCE
Poule B Match 4	EGYPT	EGY	0 - 12	TUR	TURKIYE
Poule A Match 4	FRANCE	FRA	8 - 12	ITA	ITALY
Poule B Match 4	TURKIYE	TUR	10 - 12	ALG	ALGERIA
<b>TUE 28 JUN 2022</b>					
Poule A Match 4	SAN MARINO	SMR	12 - 6	ITA	ITALY
Poule B Match 4	LIBYA	LBA	1 - 12	ALG	ALGERIA
Semi-finals	SAN MARINO	SMR	12 - 6	ALG	ALGERIA
Semi-finals	LIBYA	LBA	1 - 12	ITA	ITALY
Bronze Medal Match	ALGERIA	ALG	0 - 12	LBA	LIBYA
<b>WED 29 JUN 2022</b>					
Gold-medal Bout	SAN MARINO	SMR	7 - 11	ITA	ITALY

### LEGEND

DIS Disqualified      ELI Eliminated      ACC Injured      RET Retired  
T Two or more players share the same      WD WithDrawn



## Draw Sheet

As of TUE 5 JUL 2022 at 19:19

Semi-finals

Gold-medal Bout

MEDALLISTS		
Gold	ITALY	ITA
Silver	SAN MARINO	SM
Bronze	LIBYA	LBA

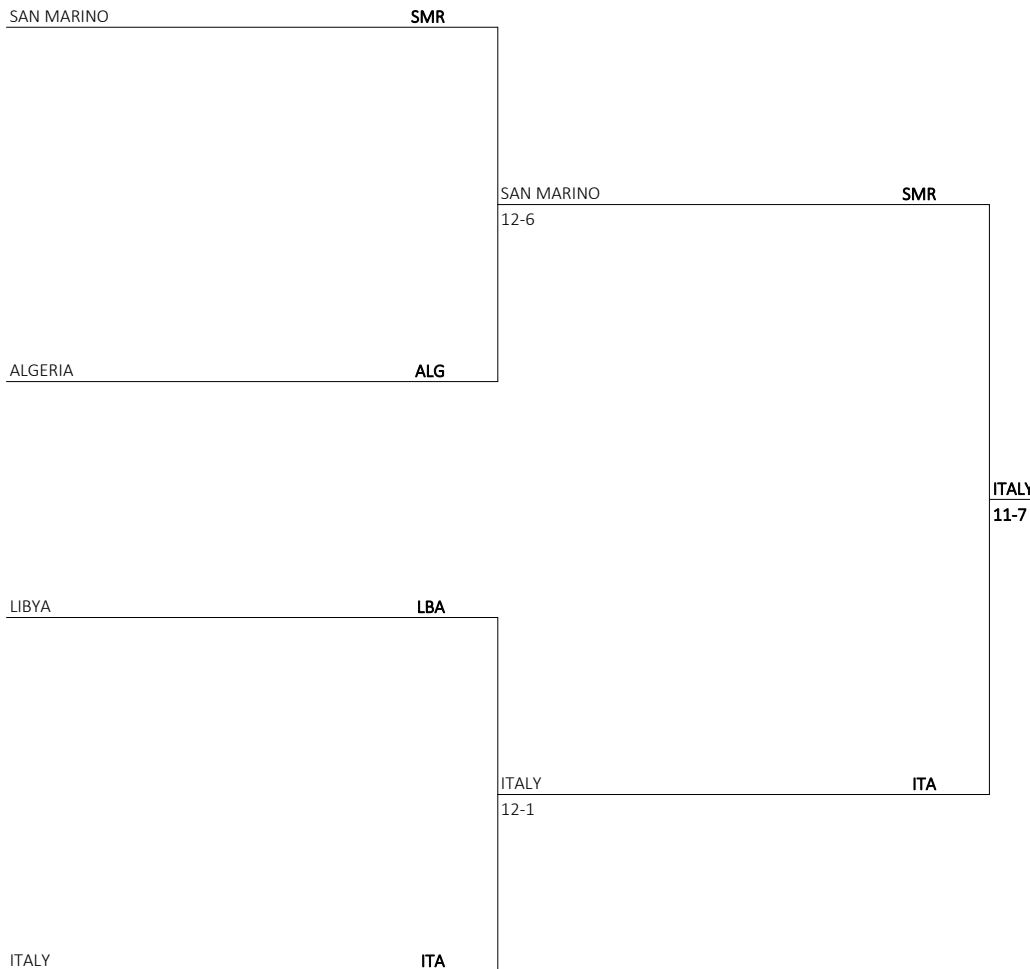



## Draw Sheet

As of TUE 5 JUL 2022 at 19:19

Bronze Medal Match

ALGERIA	ALG	
		LIBYA
		12-0
LIBYA	LBA	



## Medallists

Medal	CTRY	Name
GOLD	ITA - Italy	DI NICOLA Marco VISCONTI Mattia
SILVER	SMR - San Marino	DALL'OLMO Enrico FRISONI Jacopo
BRONZE	LBA - Libya	ALSWESI Rashed ISSA Mahmud



## Entry List by Event

CTRY	Name	Date of Birth
ALG - Algeria	BABA ARBI Ibtissam	18 JAN 1985
ESP - Spain	DIAZ REYES Sara	16 SEP 1997
	HOMAR MAYOL Melania	19 MAY 1993
FRA - France	DISIDORO Ludivine	5 FEB 1987
	ESTEVE Elodie	25 MAY 1998
ITA - Italy	SCALISE Monica	17 APR 1984
MAR - Morocco	GHARIZ Karima	14 APR 1973
MON - Monaco	CAMPILLO Sabrina	18 MAR 1983
TUN - Tunisia	BEJI EP MATTOUSSI Mouna	27 JUL 1985
	BELLI Asma	22 MAY 1989
TUR - Turkiye	ESEN Gulcin	7 APR 1980
	TATARLI Beyza	6 FEB 2004

Total number of athletes: 12



## Results

Rank	Name	CTRY	Round 1	Round 2	Total	Remarks
1	BEJI EP MATTOUSSI Mouna	TUN	32	0	32	Q
2	ESTEVE Elodie	FRA	31	0	31	Q
3	GHARIZ Karima	MAR	24	0	24	
3	DIAZ REYES Sara	ESP	24	0	24	
5	ESEN Gulcin	TUR	19	0	19	
6	CAMPILLO Sabrina	MON	10	0	10	
6	SCALISE Monica	ITA	10	0	10	
6	BABA ARBI Ibtissam	ALG	10	0	10	

### LEGEND

<b>DIS</b>	Disqualified	<b>ELI</b>	Eliminated	<b>ACC</b>	Injured	<b>RET</b>	Retired
<b>T</b>	Two or more players share the same	<b>WD</b>	WithDrawn				





## Results

Rank	Name	CTRY	Round 1	Round 2	Total	Remarks
1	BEJI EP MATTOUSSI Mouna	TUN	32	0	32	Q
2	ESTEVE Elodie	FRA	31	0	31	Q
3	DIAZ REYES Sara	ESP	24	35	59	Q
4	GHARIZ Karima	MAR	24	33	57	Q
5	ESEN Gulcin	TUR	19	20	39	
6	SCALISE Monica	ITA	10	18	28	
7	BABA ARBI Ibtissam	ALG	10	14	24	
8	CAMPILLO Sabrina	MON	10	11	21	

### LEGEND

DIS	Disqualified	ELI	Eliminated	ACC	Injured	RET	Retired
T	Two or more players share the same r	WD	WithDrawn				



## Results Summary

As of WED 29 JUN 2022 at 18:07

Match	Name	CTRY	Result	CTRY	Name
<b>MON 27 JUN 2022</b>					
Semi-finals	BEJI EP MATTOUSSI Mouna	TUN	38 - 36	MAR	GHARIZ Karima
Semi-finals	DISIDORO Ludivine	FRA	18 - 37	ESP	DIAZ REYES Sara
<b>TUE 28 JUN 2022</b>					
Bronze Medal Match	GHARIZ Karima	MAR	27 - 22	FRA	DISIDORO Ludivine
<b>WED 29 JUN 2022</b>					
Gold-medal Bout	BEJI EP MATTOUSSI Mouna	TUN	37 - 30	ESP	DIAZ REYES Sara

### LEGEND

DIS Disqualified      ELI Eliminated      ACC Injured      RET Retired  
T Two or more players share the same r      WD WithDrawn



## Draw Sheet

As of WED 29 JUN 2022 at 18:06

Semi-finals

Gold-medal Bout

BEJI M. TUN

GHARIZ K. MAR

BEJI M. TUN  
38-36

DISIDORO L. FRA

DIAZ REYES S. ESP

DIAZ REYES S. ESP  
37-18

BEJI EP MATTOUSSI MOUNA  
37-30

MEDALLISTS		
Gold	BEJI EP MATTOUSSI MOUNA	TU
Silver	DIAZ REYES SARA	ESP
Bronze	GHARIZ KARIMA	MA



## Draw Sheet

As of WED 29 JUN 2022 at 18:06

Bronze Medal Match

Ghariz K.	MAR	
		Ghariz Karima 27-22
Disidoro L.	FRA	



## Medallists

As of MON 4 JUL 2022 at 10:39

Medal	Name	CTRY
GOLD	BEJI EP MATTOUSSI Mouna	TUN - Tunisia
SILVER	DIAZ REYES Sara	ESP - Spain
BRONZE	GHARIZ Karima	MAR - Morocco



## Entry List by Event

CTRY	Name	Date of Birth
ALG - Algeria	BABA ARBI Ibtissam	18 JAN 1985
	BOUGUERRA Nour El Houda	15 JAN 1999
ESP - Spain	DIAZ REYES Sara	16 SEP 1997
	HOMAR MAYOL Melania	19 MAY 1993
FRA - France	DISIDORO Ludivine	5 FEB 1987
	ESTEVE Elodie	25 MAY 1998
ITA - Italy	SCALISE Monica	17 APR 1984
	BOTTERO Alessia	25 FEB 2000
MAR - Morocco	Ghariz Karima	14 APR 1973
	GOURAR Soukaina	14 NOV 1997
MON - Monaco	CAMPILLO Sabrina	18 MAR 1983
	CROVETTO - VIALE Laurence	4 OCT 1969
TUN - Tunisia	BEJI EP MATTOUSSI Mouna	27 JUL 1985
	BELLI Asma	22 MAY 1989
TUR - Turkiye	ESEN Gulcin	7 APR 1980
	TATARLI Beyza	6 FEB 2004

Total number of athletes: 16



## Group Play Summary

As of TUE 5 JUL 2022 at 15:07

Poule A							Matches			Remarks
Rank			A	B	C	D	Played	Won	Lost	
1	A	Tunisia	---	12-7 / 13-5	13-4		3	3	0	
2	B	Algeria	7-12 / 5-13	---	11-5	12-0	4	2	2	
3	C	Morocco	4-13	5-11	---	12-0	3	1	2	
4	D	Monaco		0-12	0-12	---	3	1	2	

Poule B							Matches			Remarks
Rank			A	B	C	D	Played	Won	Lost	
1	A	Spain	---	12-4 / 13-3	9-6		3	3	0	
2	B	Turkey	4-12 / 3-13	---	11-8	10-3	4	2	2	
3	C	France	6-9	8-11	---	13-3	3	1	2	
4	D	Italy		3-10	3-13	---	2	0	2	



## Results Summary

As of TUE 5 JUL 2022 at 19:16

Match	Name	CTRY	Result	CTRY	Name
<b>SUN 26 JUN 2022</b>					
Poule A Match 1	ALGERIA	ALG	7(RET) - 12	TUN	TUNISIA
Poule A Match 2	MOROCCO	MAR	12(RET) - 0(RET)	MON	MONACO
Poule B Match 4	SPAIN	ESP	12 - 4	TUR	TURKEY
Poule B Match 3	FRANCE	FRA	13 - 3	ITA	ITALY
<b>MON 27 JUN 2022</b>					
Poule A Match 4	MONACO	MON	0 - 12	ALG	ALGERIA
Poule A Match 1	MOROCCO	MAR	4 - 13	TUN	TUNISIA
Poule B Match 2	FRANCE	FRA	6 - 9	ESP	SPAIN
Poule B Match 3	ITALY	ITA	3 - 10	TUR	TURKEY
Poule A Match 5	ALGERIA	ALG	11 - 5	MAR	MOROCCO
Poule B Match 5	TURKEY	TUR	11 - 8	FRA	FRANCE
<b>TUE 28 JUN 2022</b>					
Semi-finals	TUNISIA	TUN	13 - 5	TUR	TURKEY
Semi-finals	SPAIN	ESP	13 - 3	ALG	ALGERIA
Bronze Medal Match	TURKEY	TUR	13 - 5	ALG	ALGERIA
Poule A Match 6	TUNISIA	TUN	13 - 5	ALG	ALGERIA
Poule B Match 6	TURKEY	TUR	3 - 13	ESP	SPAIN
<b>WED 29 JUN 2022</b>					
Gold-medal Bout	TUNISIA	TUN	13 - 6	ESP	SPAIN

### LEGEND

DIS	Disqualified	ELI	Eliminated	ACC	Injured	RET	Retired
T	Two or more players share the same	WD	WithDrawn				





## Draw Sheet

As of TUE 28 JUN 2022 at 08:07

### Semi-finals

TUNISIA	TUN
TURKEY	TUR

SPAIN	ESP
ALGERIA	ALG

### Gold-medal Bout

TUNISIA	TUN
13-5	
SPAIN	ESP
13-3	

MEDALLISTS		
Gold	TUNISIA	TU
Silver	SPAIN	ESP
Bronze	TURKEY	TUR

TUNISIA  
13-6

### Bronze Medal Match

TURKEY	TUR
ALGERIA	ALG

TURKEY  
13-5



## Medallists

Medal	CTRY	Name
GOLD	TUN - Tunisia	BEJI EP MATTOUSSI Mouna BELLI Asma
SILVER	ESP - Spain	DIAZ REYES Sara HOMAR MAYOL Melania
BRONZE	TUR - Turkiye	ESEN Gulcin TATARLI Beyza



## Entry List by Event

CTRY	Name	Date of Birth
ALG - Algeria	TOULOUM Samia	16 JUN 1984
CRO - Croatia	BAJRIC Carrolina	15 NOV 1999
ESP - Spain	SOLER VILCHEZ Cristina	17 JUN 1974
FRA - France	GOUILLOUD Pauline	7 FEB 2000
ITA - Italy	BASEI Valentina	25 OCT 1996
MAR - Morocco	LEFHAL EL ALAOUI Bouchra	3 MAY 1985
MNE - Montenegro	BOLJEVIC Nina	7 JUN 1989
SLO - Slovenia	PETRIC Tadeja	25 JUL 1989
SRB - Serbia	POPOVIC Milica	4 AUG 2001
TUN - Tunisia	MHAMDI EP JBELI Yosra	5 NOV 1983
TUR - Turkiye	OZTURK Buket	30 DEC 2001

Total number of athletes: 11



## Results

Rank	Name	CTRY	Round 1	Round 2	Total
1	PETRIC Tadeja	SLO	21	0	21
2	BAJRIC Carrolina	CRO	14	0	14
3	OZTURK Buket	TUR	12	0	12
4	MHAMDI EP JBELI Yosra	TUN	11	0	11
5	GOUILLOUD Pauline	FRA	8	0	8
5	LEFHAL EL ALAOUI Bouchra	MAR	8	0	8
7	POPOVIC Milica	SRB	6	0	6
8	SOLER VILCHEZ Cristina	ESP	5	0	5
9	BOLJEVIC Nina	MNE	4	0	4
10	TOULOUM Samia	ALG	3	0	3
10	BASEI Valentina	ITA	3	0	3

### LEGEND

<b>DIS</b>	Disqualified	<b>ELI</b>	Eliminated	<b>ACC</b>	Injured	<b>RET</b>	Retired
<b>T</b>	Two or more players share the same	<b>WD</b>	WithDrawn				



## Results

Rank	Name	CTRY	Round 1	Round 2	Total	Remarks
1	OZTURK Buket	TUR	12	22	34	Q
2	PETRIC Tadeja	SLO	21	11	32	Q
3	MHAMDI EP JBELI Yosra	TUN	11	20	31	Q
3	BAJRIC Carrolina	CRO	14	17	31	Q
5	GOUILLOUD Pauline	FRA	8	12	20	Q
6	LEFHAL EL ALAOUI Bouchra	MAR	8	11	19	Q
6	BASEI Valentina	ITA	3	16	19	Q
8	SOLER VILCHEZ Cristina	ESP	5	13	18	Q
8	POPOVIC Milica	SRB	6	12	18	
10	BOLJEVIC Nina	MNE	4	10	14	
11	TOULOUM Samia	ALG	3	3	6	

### LEGEND

<b>DIS</b>	Disqualified	<b>ELI</b>	Eliminated	<b>ACC</b>	Injured	<b>RET</b>	Retired
<b>T</b>	Two or more players share the same	<b>WD</b>	WithDrawn				



## Results Summary

As of WED 29 JUN 2022 at 18:16

Match	Name	CTRY	Result	CTRY	Name
<b>SAT 30 DEC 1899</b>					
Quarter-finals Contest 1	MHAMDI EP JBELI Yosra	TUN	18 - 19	ITA	BASEI Valentina
Quarter-finals Contest 2	PETRIC Tadeja	SLO	16 - 8	MAR	LEFHAL EL ALAOUI Bouchra
Quarter-finals Contest 3	OZTURK Buket	TUR	16 - 5	ESP	SOLER VILCHEZ Cristina
Quarter-finals Contest 4	BAJRIC Carrolina	CRO	11 - 10	FRA	GOUILLOUD Pauline
<b>TUE 28 JUN 2022</b>					
Semi-finals	BASEI Valentina	ITA	20 - 19	SLO	PETRIC Tadeja
Semi-finals	OZTURK Buket	TUR	13 - 8	CRO	BAJRIC Carrolina
<b>WED 29 JUN 2022</b>					
Bronze Medal Match	PETRIC Tadeja	SLO	24 - 18	CRO	BAJRIC Carrolina
Gold-medal Bout	BASEI Valentina	ITA	7 - 14	TUR	OZTURK Buket

### LEGEND

DIS Disqualified      ELI Eliminated      ACC Injured      RET Retired  
T Two or more players share the same r      WD WithDrawn



## Draw Sheet

As of WED 29 JUN 2022 at 18:15

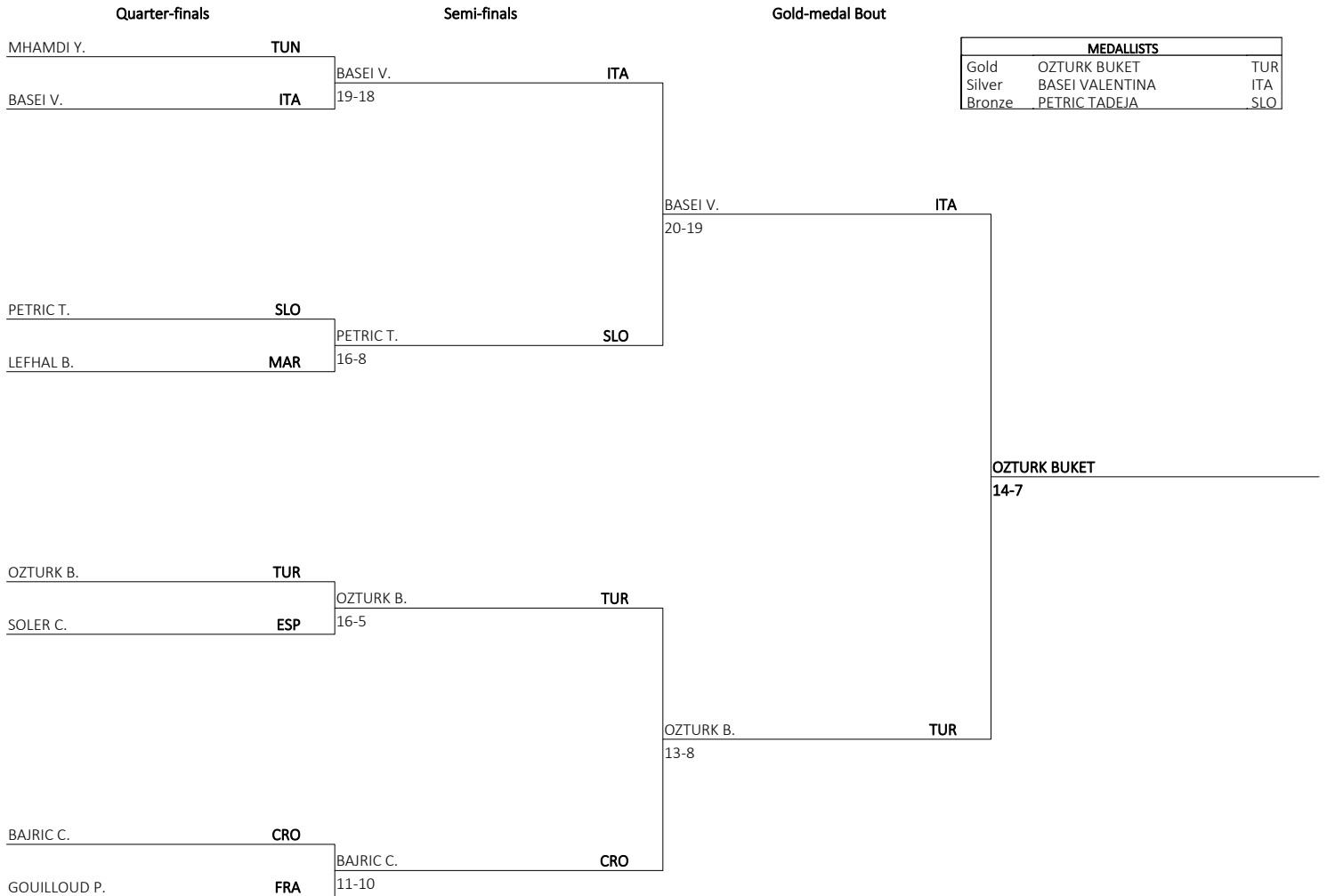

MEDALLISTS		
Gold	OZTURK BUKET	TUR
Silver	BASEI VALENTINA	ITA
Bronze	PETRIC TADEJA	SLO



## Draw Sheet

As of WED 29 JUN 2022 at 18:15

Bronze Medal Match

PETRIC T.	SLO	
		PETRIC TADEJA
		24-18
BAJRIC C.	CRO	





## Medallists

As of MON 4 JUL 2022 at 10:41

Medal	Name	CTRY
GOLD	OZTURK Buket	TUR - Turkiye
SILVER	BASEI Valentina	ITA - Italy
BRONZE	PETRIC Tadeja	SLO - Slovenia



## Entry List by Event

CTRY	Name	Date of Birth
ALG - Algeria	AFENAI Celia	26 FEB 1997
CRO - Croatia	VOJKOVIC Ria	17 JUL 2002
FRA - France	GOUILLOUD Pauline	7 FEB 2000
ITA - Italy	TRAVERSA Serena	7 OCT 1998
MNE - Montenegro	BOLJEVIC Nina	7 JUN 1989
SLO - Slovenia	VOLCINA Nina	20 APR 2000
TUR - Turkiye	OZTURK Inci Ece	22 MAR 1997

Total number of athletes: 7



## Results

Rank	Name	CTRY	Round 1	Round 2	Total
1	TRAVERSA Serena	ITA	39	0	39
2	VOLCINA Nina	SLO	35	0	35
3	OZTURK Inci Ece	TUR	34	0	34
4	VOJKOVIC Ria	CRO	29	0	29
5	GOUILLOUD Pauline	FRA	28	0	28
6	AFENAI Celia	ALG	21	0	21
7	BOLJEVIC Nina	MNE	16	0	16

### LEGEND

<b>DIS</b>	Disqualified	<b>ELI</b>	Eliminated	<b>ACC</b>	Injured	<b>RET</b>	Retired
<b>T</b>	Two or more players share the same	<b>WD</b>	WithDrawn				



## Results

Rank	Name	CTRY	Round 1	Round 2	Total	Remarks
1	TRAVERSA Serena	ITA	39	37	76	Q
2	OZTURK Inci Ece	TUR	34	35	69	Q
3	VOLCINA Nina	SLO	35	26	61	Q
4	VOJKOVIC Ria	CRO	29	32	61	Q
5	BARTHET Barbara	FRA	28	33	61	
6	AFENAI Celia	ALG	21	20	41	
7	BOLJEVIC Nina	MNE	16	17	33	

### LEGEND

DIS	Disqualified	ELI	Eliminated	ACC	Injured	RET	Retired
T	Two or more players share the same r	WD	WithDrawn				



## Results Summary

As of WED 29 JUN 2022 at 16:15

Match	Name	CTRY	Result	CTRY	Name
<b>MON 27 JUN 2022</b>					
Quarter-finals Contest 4	GOUILLOUD Pauline	FRA	33 - 33	CRO	VOJKOVIC Ria
Quarter-finals Contest 1	VOLCINA Nina	SLO	35 - 11	ALG	AFENAI Celia
Quarter-finals Contest 2	OZTURK Inci Ece	TUR	39 - 16	MNE	BOLJEVIC Nina
Quarter-finals Contest 3	TRAVERSA Serena	ITA	20:30		
<b>TUE 28 JUN 2022</b>					
Semi-finals	TRAVERSA Serena	ITA	32 - 36	CRO	VOJKOVIC Ria
Semi-finals	VOLCINA Nina	SLO	28 - 34	TUR	OZTURK Inci Ece
Bronze Medal Match	VOLCINA Nina	SLO	36 - 38	ITA	TRAVERSA Serena
<b>WED 29 JUN 2022</b>					
Gold-medal Bout	OZTURK Inci Ece	TUR	35 - 28	CRO	VOJKOVIC Ria

### LEGEND

DIS Disqualified      ELI Eliminated      ACC Injured      RET Retired  
T Two or more players share the same r      WD WithDrawn



## Draw Sheet

As of WED 29 JUN 2022 at 16:14

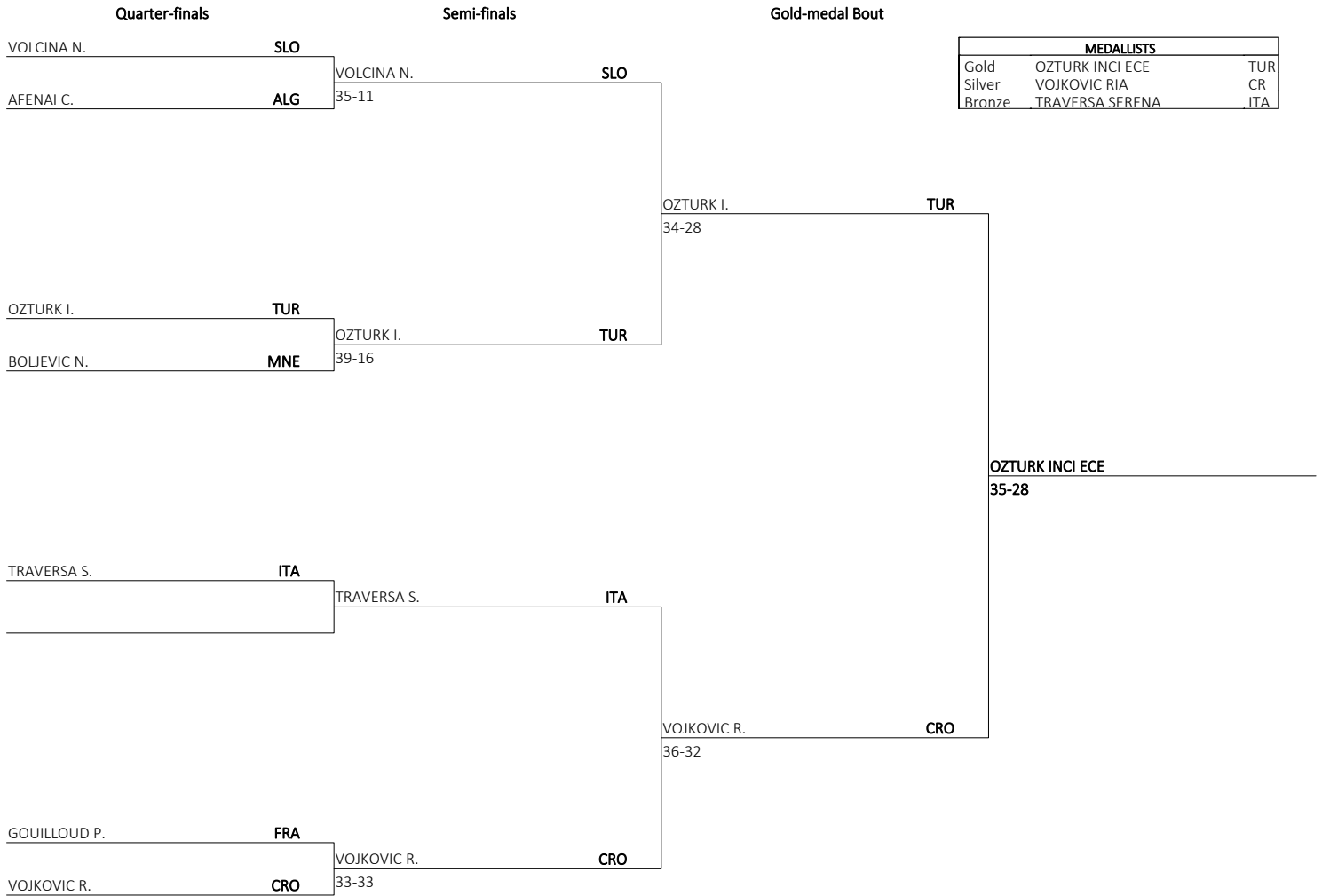

MEDALLISTS		
Gold	OZTURK INCI ECE	TUR
Silver	VOJKOVIC RIA	CR
Bronze	TRAVERSA SERENA	ITA



## Draw Sheet

As of WED 29 JUN 2022 at 16:14

Bronze Medal Match

VOLCINA N.	SLO	
		TRAVERSA SERENA
		38-36
TRAVERSA S.	ITA	



Complexe LOFA

Boules

Women's Lyonnaise Progressive



## Medallists

As of MON 4 JUL 2022 at 10:40

Medal	Name	CTRY
GOLD	OZTURK Inci Ece	TUR - Turkiye
SILVER	VOJKOVIC Ria	CRO - Croatia
BRONZE	TRAVERSA Serena	ITA - Italy





## Entry List by Event

CTRY	Name	Date of Birth
ALG - Algeria	AISSIOUI Lamia	13 OCT 1980
FRA - France	TAHRAOUI Meriem	24 JUL 1982
ITA - Italy	MORELLI Flavia	
LBA - Libya	ELBEZ Soumaya	25 FEB 1979
SMR - San Marino	PAOLETTI Stella	18 FEB 2000
TUR - Turkiye	CIL Bahar	26 MAR 1997

Total number of athletes: 6



## Group Play Summary

As of TUE 5 JUL 2022 at 19:08

Poule A						Matches			Remarks
Rank			A	B	C	Played	Won	Lost	
1	A	MORELLI F. (ITA)	---	12-0 / 5-12	12-0	3	2	1	
2	B	CIL B. (TUR)	0-12 / 12-5	---	8-5	3	2	1	
3	C	ELBEZ S. (LBA)	0-12	5-8	---	2	0	2	

Poule B						Matches			Remarks
Rank			A	B	C	Played	Won	Lost	
1	A	AISSIOUI L. (ALG)	---	8-12 / 11-10	12-4	3	2	1	
2	B	PAOLETTI S. (SMR)	12-8 / 10-11	---	12-9	3	2	1	
3	C	TAHRAOUI M. (FRA)	4-12	9-12	---	2	0	2	



## Results Summary

As of TUE 5 JUL 2022 at 19:16

Match	Name	CTRY	Result	CTRY	Name
<b>SAT 30 DEC 1899</b>					
Poule A Match 2			00:00	TUR	CIL Bahar
Poule B Match 2	AISSIOUI Lamia	ALG	00:00		
Poule A Match 4			00:00	LBA	ELBEZ Soumaya
<b>SUN 26 JUN 2022</b>					
Poule A Match 1	MORELLI Flavia	ITA	12 - 0	LBA	ELBEZ Soumaya
Poule B Match 3	AISSIOUI Lamia	ALG	8 - 12	SMR	PAOLETTI Stella
<b>MON 27 JUN 2022</b>					
Poule B Match 1	PAOLETTI Stella	SMR	12 - 9	FRA	TAHRAOUI Meriem
Poule A Match 3	CIL Bahar	TUR	0 - 12	ITA	MORELLI Flavia
Poule A Match 5	ELBEZ Soumaya	LBA	5 - 8	TUR	CIL Bahar
Poule B Match 5	TAHRAOUI Meriem	FRA	4 - 12	ALG	AISSIOUI Lamia
<b>TUE 28 JUN 2022</b>					
Poule B Match 6	PAOLETTI Stella	SMR	10 - 11	ALG	AISSIOUI Lamia
Poule A Match 6	MORELLI Flavia	ITA	5 - 12	TUR	CIL Bahar
Semi-finals	PAOLETTI Stella	SMR	5 - 12	TUR	CIL Bahar
Semi-finals	AISSIOUI Lamia	ALG	11 - 10	ITA	MORELLI Flavia
<b>WED 29 JUN 2022</b>					
Bronze Medal Match	MORELLI Flavia	ITA	12 - 3	SMR	PAOLETTI Stella
Gold-medal Bout	AISSIOUI Lamia	ALG	7 - 9	TUR	CIL Bahar

### LEGEND

DIS	Disqualified	ELI	Eliminated	ACC	Injured	RET	Retired
T	Two or more players share the same	WD	WithDrawn				



## Draw Sheet

As of TUE 5 JUL 2022 at 19:10

Semi-finals

Gold-medal Bout

MEDALLISTS		
Gold	CIL BAHAR	TUR
Silver	AISSIOUI LAMIA	ALG
Bronze	MORELLI FLAVIA	ITA

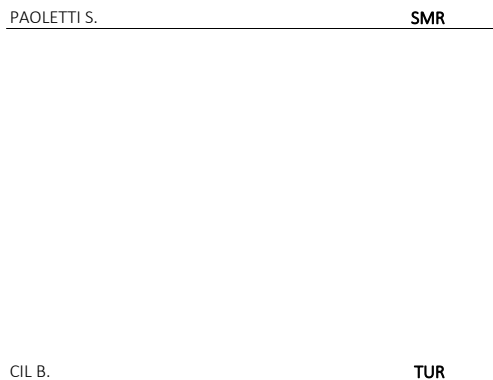
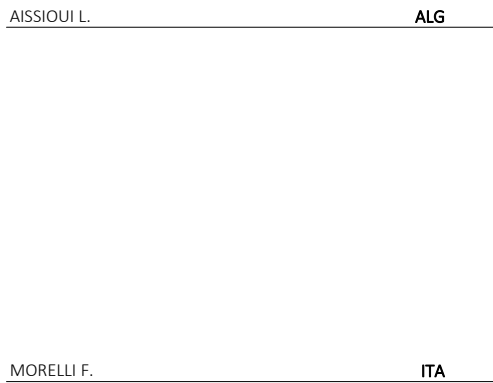

CIL BAHAR  
9-7



## Draw Sheet

As of TUE 5 JUL 2022 at 19:10

Bronze Medal Match

MORELLI F.	ITA	
		MORELLI FLAVIA
		12-3
PAOLETTI S.	SMR	



## Medallists

As of MON 4 JUL 2022 at 10:42

Medal	Name	CTRY
GOLD	CIL Bahar	TUR - Turkiye
SILVER	AISSIOUI Lamia	ALG - Algeria
BRONZE	MORELLI Flavia	ITA - Italy



## Entry List by Event

CTRY	Name	Date of Birth
ALG - Algeria	AISSIOUI Lamia	13 OCT 1980
	CHIBANI Chahrezad	15 APR 1980
FRA - France	MILLERON Mireille	1 MAR 1969
	TAHRAOUI Meriem	24 JUL 1982
ITA - Italy	MORELLI Flavia	
	TRECCANI Ilaria	14 JUL 2001
LBA - Libya	ELBEZ Soumaya	25 FEB 1979
	ALZINTANI Nagah	8 APR 1985
SMR - San Marino	CIUCCI Anna Maria	5 JAN 1954
	PAOLETTI Stella	18 FEB 2000
TUR - Turkiye	CIL Bahar	26 MAR 1997
	DEMIR Pinar	5 SEP 1995

Total number of athletes: 12



## Group Play Summary

As of TUE 5 JUL 2022 at 15:07

Poule A							Matches			Remarks
Rank			A	B	C	D	Played	Won	Lost	
1	A	San Marino	---	12-7 / 12-5		12-0	3	3	0	
2	B	Italy	7-12 / 5-12	---	12-7 / 11-9		4	2	2	
3	C	France		7-12 / 9-11	---	12-0	3	1	2	
4	D	Egypt	0-12		0-12	---	2	0	2	

Poule B							Matches			Remarks
Rank			A	B	C		Played	Won	Lost	
1	A	Algeria	---	12-0	12-4		2	2	0	
2	B	Turkey	0-12	---	8-5		2	1	1	
3	C	Libya	4-12	5-8	---		2	0	2	





## Results Summary

As of TUE 5 JUL 2022 at 19:15

Match	Name	CTRY	Result	CTRY	Name
<b>SAT 30 DEC 1899</b>					
Poule B Match 2	LIBYA	LBA	00:00		
Poule B Match 5	TURKEY	TUR	00:00		
<b>SUN 26 JUN 2022</b>					
Poule A Match 1	ITALY	ITA	12 - 7	FRA	FRANCE
Poule A Match 2	SAN MARINO	SMR	12 - 0	EGY	EGYPT
Poule A Match 3	ITALY	ITA	7 - 12	SMR	SAN MARINO
Poule A Match 4	EGYPT	EGY	0 - 12	FRA	FRANCE
Poule B Match 1	ALGERIA	ALG	12 - 0	TUR	TURKEY
<b>MON 27 JUN 2022</b>					
Poule A Match 5	FRANCE	FRA	9 - 11	ITA	ITALY
Poule B Match 6	TURKEY	TUR	8 - 5	LBA	LIBYA
<b>TUE 28 JUN 2022</b>					
Poule B Match 1	ALGERIA	ALG	0 - 0	TUR	TURKEY
Poule A Match 6	SAN MARINO	SMR	12 - 5	ITA	ITALY
Semi-finals	ALGERIA	ALG	11 - 12	ITA	ITALY
Semi-finals	SAN MARINO	SMR	12 - 5	TUR	TURKEY
Bronze Medal Match	ALGERIA	ALG	12 - 4	TUR	TURKEY
<b>WED 29 JUN 2022</b>					
Gold-medal Bout	ITALY	ITA	3 - 12	SMR	SAN MARINO

### LEGEND

DIS	Disqualified	ELI	Eliminated	ACC	Injured	RET	Retired
T	Two or more players share the same	WD	WithDrawn				



## Draw Sheet

As of TUE 5 JUL 2022 at 19:15

Semi-finals

Gold-medal Bout

MEDALLISTS		
Gold	SAN MARINO	SM
Silver	ITALY	ITA
Bronze	ALGERIA	ALG

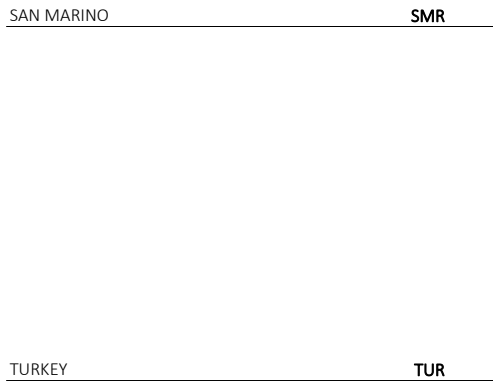

SAN MARINO  
12-3



## Draw Sheet

As of TUE 5 JUL 2022 at 19:15

Bronze Medal Match

ALGERIA	ALG	
TURKEY	TUR	ALGERIA 12-4



## Medallists

Medal	CTRY	Name
GOLD	SMR - San Marino	CIUCCI Anna Maria PAOLETTI Stella
SILVER	ITA - Italy	MORELLI Flavia TRECCANI Ilaria
BRONZE	ALG - Algeria	AISSIOUI Lamia CHIBANI Chahrezad



ألعاب البحر الأبيض المتوسط  
MEDITERRANEAN GAMES  
JEUX MÉDITERRANÉENS  
du 25 juin au 06 juillet

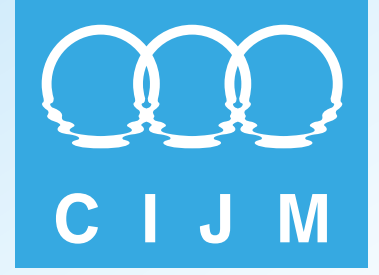

## Results Book



## Boxing



**TOSYALI  
ALGERIE**

Fer et Acier

سوناطراي



sonarach



microplus  
DATA PROCESSING & TIMING  
[www.microplustiming.com](http://www.microplustiming.com)



## Competition Schedule

THU 30 JUN 2022

Session 10 - Start time 18:00

Order	Bout	Phase	Weight Category	Corner	Name	Ctry
1	1	Semi-finals	Men (57kg)	RED	ZOUHAIRI Abdellatif	MAR
				BLU	CIFTCI Batuhan	TUR
2	2	Semi-finals	Men (57kg)	RED	MORDJANE Oussama	ALG
				BLU	MHAMDI Bilel	TUN
3	3	Semi-finals	Men (60kg)	RED	BENLARIBI Abdelnacer	ALG
				BLU	GRAU Enzo, Claude, Michel	FRA
4	4	Semi-finals	Men (60kg)	RED	CANONICO Giuseppe	ITA
				BLU	HAMOUT Mohamed	MAR
5	5	Semi-finals	Men (63kg)	RED	NADIR Abdelhaq	MAR
				BLU	MALANGA Gianluigi	ITA
6	6	Semi-finals	Men (63kg)	RED	ABDELLI Yahia	ALG
				BLU	BAJOKU Shpetim	KOS
7	7	Semi-finals	Men (69kg)	RED	EL BARBARI Hamza	MAR
				BLU	AIT-BEKKA Jugurtha	ALG
8	8	Semi-finals	Men (69kg)	RED	ELSAYED Omar	EGY
				BLU	SAVKOVIC Stefan	MNE
9	9	Semi-finals	Men (75kg)	RED	GHOUSOON Ahmad	SYR
				BLU	FENDERO Moreno	FRA
10	10	Semi-finals	Men (75kg)	RED	CAVALLARO Salvatore	ITA
				BLU	NEMOUCHI Younes	ALG
11	11	Semi-finals	Men (81kg)	RED	HOUMRI Mohammed	ALG
				BLU	MARCIC Petar	MNE
12	12	Semi-finals	Men (81kg)	RED	MIRONCHIKOV Vladimir	SRB
				BLU	JALIDOV GAFUROVA Gazimagomed	ESP
13	13	Semi-finals	Men (91kg)	RED	BOUAFIA Soheb, Youcef	FRA
				BLU	HAMANI Moh Said	ALG
14	14	Semi-finals	Men (91kg)	RED	NANITZANIAN Vagkan	GRE
				BLU	MOUHIIDINE Aziz Abbas	ITA



## Competition Schedule

THU 30 JUN 2022

Session 9 - Start time 14:00

Order	Bout	Phase	Weight Category	Corner	Name	Ctry
1	1	Semi-finals	Women (48kg)	RED	HAFSI Wafa	TUN
				BLU	CAGIRIR Ayse	TUR
2	2	Semi-finals	Women (48kg)	RED	LOPEZ DEL ARBOL Marta	ESP
				BLU	BOUALAM Roumaysa	ALG
3	3	Semi-finals	Women (50kg)	RED	FUERTES FERNANDEZ Laura	ESP
				BLU	SORRENTINO Giordana	ITA
4	4	Semi-finals	Women (50kg)	RED	CAKIROGLU Buse Naz	TUR
				BLU	MOULAI Romane	FRA
5	5	Semi-finals	Women (54kg)	RED	ABDELKADER HEDJALA Fatma Zohra	ALG
				BLU	GOJKOVIC Bojana	MNE
6	6	Semi-finals	Women (54kg)	RED	AKBAS Hatice	TUR
				BLU	AYYAD Yomna	EGY
7	7	Semi-finals	Women (60kg)	RED	KHELIF Hadjila	ALG
				BLU	ZIDANI Amina	FRA
8	8	Semi-finals	Women (60kg)	RED	NICOLI Rebecca	ITA
				BLU	RHADDI Chaymae	MAR
9	9	Semi-finals	Women (63kg)	RED	OZER Gizem	TUR
				BLU	KHELIF Imane	ALG
10	10	Semi-finals	Women (63kg)	RED	LARCHE Thaïs, Alice	FRA
				BLU	CANFORA Assunta	ITA
11	11	Semi-finals	Women (66kg)	RED	CHAIB Ichrak	ALG
				BLU	BEL AHBIB Oumayma	MAR
12	12	Semi-finals	Women (66kg)	RED	GEMINI Melissa	ITA
				BLU	SURMENELI Busenaz	TUR
13	13	Semi-finals	Men (52kg)	RED	SERRA Federico Emilio	ITA
				BLU	GUMUS Samet	TUR
14	14	Semi-finals	Men (52kg)	RED	MORTAJI Said	MAR
				BLU	AMETOVIC Omer	SRB



## Competition Schedule

WED 29 JUN 2022

Session 8 - Start time 18:00

Order	Bout	Phase	Weight Category	Corner	Name	Ctry
1	1	Quarter-finals	Men (63kg)	RED	ALICIC Semiz	SRB
				BLU	NADIR Abdelhaq	MAR
2	2	Quarter-finals	Men (63kg)	RED	CHRISTODOULOU Alexandros	CYP
				BLU	MALANGA Gianluigi	ITA
3	3	Quarter-finals	Men (63kg)	RED	ABDELLI Yahia	ALG
				BLU	OZMEN Kerem	TUR
4	4	Quarter-finals	Men (63kg)	RED	BAJOKU Shpetim	KOS
				BLU	AMEN Essam	EGY
5	5	Quarter-finals	Men (69kg)	RED	DEDIC Gianni	BIH
				BLU	EL BARBARI Hamza	MAR
6	6	Quarter-finals	Men (69kg)	RED	AIT-BEKKA Jugurtha	ALG
				BLU	BEQIRI Alban	ALB
7	7	Quarter-finals	Men (69kg)	RED	ELSAYED Omar	EGY
				BLU	ALI Ibrahim	LBA
8	8	Quarter-finals	Men (69kg)	RED	SAVKOVIC Stefan	MNE
				BLU	CAVALLARO Salvatore	ITA
9	9	Quarter-finals	Men (75kg)	RED	GHOUSOON Ahmad	SYR
				BLU	MEMIC Almir	SRB
10	10	Quarter-finals	Men (75kg)	RED	FENDERO Moreno	FRA
				BLU	ABDALLA Aly	EGY
11	11	Quarter-finals	Men (75kg)	RED	CAVALLARO Salvatore	ITA
				BLU	AMROUG Zine Elabidine	MAR
12	12	Quarter-finals	Men (75kg)	RED	NEMOUCHI Younes	ALG
				BLU	CVITANOVIC Leo	BIH





## Competition Schedule

WED 29 JUN 2022

Session 7 - Start time 14:00

Order	Bout	Phase	Weight Category	Corner	Name	Ctry
1	1	Quarter-finals	Men (52kg)	RED	SERRA Federico Emilio	ITA
				BLU	MOLINA SALVADOR Martin	ESP
2	2	Quarter-finals	Men (52kg)	RED	GUMUS Samet	TUR
				BLU	BAJOKU Bashkim	KOS
3	3	Quarter-finals	Men (52kg)	RED	MORTAJI Said	MAR
				BLU	BOUKEDIM Ibrahim	FRA
4	4	Quarter-finals	Men (52kg)	RED	AMETOVIC Omer	SRB
				BLU	HAJRI Mehdi	TUN
5	5	Quarter-finals	Men (57kg)	RED	ABOZAID Omar	EGY
				BLU	ZOUHAIRI Abdellatif	MAR
6	6	Quarter-finals	Men (57kg)	RED	CIFTCI Batuhan	TUR
				BLU	BARRUL FERNANDEZ Antonio	ESP
7	7	Quarter-finals	Men (57kg)	RED	RAHIMIC Alen	BIH
				BLU	MORDJANE Oussama	ALG
8	8	Quarter-finals	Men (57kg)	RED	JOUKHDAR Belal	SYR
				BLU	MHAMDI Bilel	TUN
9	9	Quarter-finals	Men (60kg)	RED	QUILES BROTONS Jose	ESP
				BLU	BENLARIBI Abdelnacer	ALG
10	10	Quarter-finals	Men (60kg)	RED	GRAU Enzo, Claude, Michel	FRA
				BLU	CERNOGA Tadej	SLO
11	11	Quarter-finals	Men (60kg)	RED	CANONICO Giuseppe	ITA
				BLU	IVKOVIC Nikola	BIH
12	12	Quarter-finals	Men (60kg)	RED	HAMOUT Mohamed	MAR
				BLU	SEJDI Nazif	SRB
13	13	Semi-finals	Men (+91kg)	RED	HAFEZ Yousry	EGY
				BLU	BOULODINATS Chouaib	ALG
14	14	Semi-finals	Men (+91kg)	RED	ABOUDOU MOINDZE Djamil-dini	FRA
				BLU	FIASCHETTI Vincenzo	ITA



## Competition Schedule

TUE 28 JUN 2022

Session 6 - Start time 18:00

Order	Bout	Phase	Weight Category	Corner	Name	Ctry
1	1	Quarter-finals	Men (81kg)	RED	HOUMRI Mohammed	ALG
				BLU	ASSAGHIR Mohamed	MAR
2	2	Quarter-finals	Men (81kg)	RED	ABDELGAWWAD Abdelrahman	EGY
				BLU	MARCIC Petar	MNE
3	3	Quarter-finals	Men (81kg)	RED	MIRONCHIKOV Vladimir	SRB
				BLU	AYKUTSUN Kaan	TUR
4	4	Quarter-finals	Men (81kg)	RED	JALIDOV GAFUROVA Gazimagomed	ESP
				BLU	DANANOVIC Ahmed	BIH
5	5	Quarter-finals	Men (91kg)	RED	BOSNJAK Dzermal	BIH
				BLU	BOUAFIA Soheb, Youcef	FRA
6	6	Quarter-finals	Men (91kg)	RED	HAMANI Moh Said	ALG
				BLU	GHOUSOON Alaa Eldin	SYR
7	7	Quarter-finals	Men (91kg)	RED	IBRAHIM Mohamed	EGY
				BLU	NANITZANIAN Vagkan	GRE
8	8	Quarter-finals	Men (91kg)	RED	REYES PLA Enmanuel	ESP
				BLU	MOUHIIDINE Aziz Abbas	ITA



## Competition Schedule

TUE 28 JUN 2022

Session 5 - Start time 14:00

Order	Bout	Phase	Weight Category	Corner	Name	Ctry
1	1	Quarter-finals	Women (48kg)	RED	CAGIRIR Ayse	TUR
				BLU	BONATTI Roberta	ITA
2	2	Quarter-finals	Women (48kg)	RED	MOUTTAKI Yasmine	MAR
				BLU	LOPEZ DEL ARBOL Marta	ESP
3	3	Quarter-finals	Women (48kg)	RED	YOUSSEF Salma	EGY
				BLU	BOUALAM Roumaysa	ALG
4	4	Quarter-finals	Women (50kg)	RED	MOHAMED Eman	EGY
				BLU	SORRENTINO Giordana	ITA
5	5	Quarter-finals	Women (50kg)	RED	MANSOURI Fatiha	ALG
				BLU	CAKIROGLU Buse Naz	TUR
6	6	Quarter-finals	Women (54kg)	RED	ABDELKADER HEDJALA Fatma Zohra	ALG
				BLU	BERTAL Widad	MAR
7	7	Quarter-finals	Women (54kg)	RED	GOJKOVIC Bojana	MNE
				BLU	CACIC Nikolina	CRO
8	8	Quarter-finals	Women (54kg)	RED	CHARAABI Sirine	ITA
				BLU	AKBAS Hatice	TUR
9	9	Quarter-finals	Women (54kg)	RED	AYYAD Yomna	EGY
				BLU	MADUENO CONDE Maria Del Carmen	ESP
10	10	Quarter-finals	Women (60kg)	RED	HUSSEIN Mariam	EGY
				BLU	ZIDANI Amina	FRA
11	11	Quarter-finals	Women (60kg)	RED	PAPADATOU Olga Pavlina	GRE
				BLU	NICOLI Rebecca	ITA
12	12	Quarter-finals	Women (60kg)	RED	RHADDI Chaymae	MAR
				BLU	HOMRANI EP ZAYANI Mariem	TUN



## Competition Schedule

MON 27 JUN 2022

Session 4 - Start time 18:00

Order	Bout	Phase	Weight Category	Corner	Name	Ctry
1	1	Round of 16	Men (57kg)	RED	ZOUHAIRI Abdellatif	MAR
				BLU	MURJA Ardit	ALB
2	2	Round of 16	Men (57kg)	RED	MORDJANE Oussama	ALG
				BLU	IOZIA Francesco	ITA
3	3	Round of 16	Men (57kg)	RED	MURATI Lorent	KOS
				BLU	JOUKHDAR Belal	SYR
4	4	Round of 16	Men (60kg)	RED	DOGAN Hakan	TUR
				BLU	BENLARIBI Abdelnacer	ALG
5	5	Round of 16	Men (60kg)	RED	HAMOUT Mohamed	MAR
				BLU	KOMSAN Mostfaa	EGY
6	6	Round of 16	Men (81kg)	RED	ASSAGHIR Mohamed	MAR
				BLU	KONE Cheikhmar	FRA
7	7	Round of 16	Men (81kg)	RED	PLANTIC Damir	CRO
				BLU	ABDELGAWWAD Abdelrahman	EGY
8	8	Round of 16	Men (81kg)	RED	YOUSSEF Abd Alhameed	SYR
				BLU	AYKUTSUN Kaan	TUR
9	9	Round of 16	Men (81kg)	RED	COMMEY Alfred Cromwell	ITA
				BLU	JALIDOV GAFUROVA Gazimagomed	ESP



## Competition Schedule

MON 27 JUN 2022

Session 3 - Start time 14:00

Order	Bout	Phase	Weight Category	Corner	Name	Ctry
1	1	Quarter-finals	Women (63kg)	RED	KHELIF Imane	ALG
				BLU	MOHAMED Rahma	EGY
2	2	Quarter-finals	Women (63kg)	RED	LARCHE Thais, Alice	FRA
				BLU	BOHATJUK Tara	BIH
3	3	Quarter-finals	Women (66kg)	RED	BENMESSAHEL Fatia, Lamia	FRA
				BLU	BEL AHBIB Oumayma	MAR
4	4	Quarter-finals	Women (66kg)	RED	GEMINI Melissa	ITA
				BLU	KHALED Arwa	EGY
5	5	Quarter-finals	Women (66kg)	RED	GAJIC Nikolina	SRB
				BLU	SURMENELI Busenaz	TUR
6	6	Round of 16	Men (52kg)	RED	ISMAIL Ahmed	EGY
				BLU	MOLINA SALVADOR Martin	ESP
7	7	Round of 16	Men (52kg)	RED	AGANOVIC Haris	BIH
				BLU	BOUKEDIM Ibrahim	FRA
8	8	Round of 16	Men (52kg)	RED	AMETOVIC Omer	SRB
				BLU	TOUAREG Mohamed Yassine	ALG
9	9	Quarter-finals	Men (+91kg)	RED	FIRISSE Mohamed	MAR
				BLU	HAFEZ Yousry	EGY
10	10	Quarter-finals	Men (+91kg)	RED	AYDEMIR Ugur	TUR
				BLU	BOULODINATS Chouaib	ALG
11	11	Quarter-finals	Men (+91kg)	RED	ABOUDOU MOINDZE Djamil-dini	FRA
				BLU	MLAIYES Mohammad	SYR
12	12	Quarter-finals	Men (+91kg)	RED	HYSA Nelson	ALB
				BLU	FIASCHETTI Vincenzo	ITA



## Competition Schedule

SUN 26 JUN 2022

Session 2 - Start time 18:00

Order	Bout	Phase	Weight Category	Corner	Name	Ctry
1	1	Round of 16	Men (69kg)	RED	EL BARBARI Hamza	MAR
				BLU	BEHRAMI Patriot	KOS
2	2	Round of 16	Men (69kg)	RED	AIT-BEKKA Jugurtha	ALG
				BLU	JEZEK Noa	CRO
3	3	Round of 16	Men (69kg)	RED	EKINCI Necat	TUR
				BLU	BEQIRI Alban	ALB
4	4	Round of 16	Men (69kg)	RED	GRAU Hugo Fernand Robert	FRA
				BLU	ELSAYED Omar	EGY
5	5	Round of 16	Men (69kg)	RED	NAKKASH Abdulhadi	SYR
				BLU	ALI Ibrahim	LBA
6	6	Round of 16	Men (69kg)	RED	SAVKOVIC Stefan	MNE
				BLU	PAFIOS Rafail	CYP
7	7	Round of 16	Men (91kg)	RED	AKSIN Burak	TUR
				BLU	BOUAFIA Soheb, Youcef	FRA



## Competition Schedule

SUN 26 JUN 2022

Session 1 - Start time 14:00

Order	Bout	Phase	Weight Category	Corner	Name	Ctry
1	1	Round of 16	Women (54kg)	RED	BERTAL Widad	MAR
				BLU	FRIGA Salma	FRA
2	2	Round of 16	Women (54kg)	RED	AKBAS Hatice	TUR
				BLU	CHEBBI Amel	TUN
3	3	Round of 16	Women (54kg)	RED	AYYAD Yomna	EGY
				BLU	KHATOUN Zeinab	LBN
4	4	Round of 16	Men (63kg)	RED	NADIR Abdelhaq	MAR
				BLU	NIKOLOV-VEBER Nik	SLO
5	5	Round of 16	Men (63kg)	RED	OZMEN Kerem	TUR
				BLU	VELJOVIC Luka	BIH
6	6	Round of 16	Men (63kg)	RED	SASSI Abdesalem	TUN
				BLU	BAJOKU Shpetim	KOS
7	7	Round of 16	Men (75kg)	RED	MEMIC Almir	SRB
				BLU	HASHEM Ali	LBN
8	8	Round of 16	Men (75kg)	RED	FENDERO Moreno	FRA
				BLU	KAJOSHI Arjon	ALB
9	9	Round of 16	Men (75kg)	RED	DAWKU Asim	LBA
				BLU	ABDALLA Aly	EGY
10	10	Round of 16	Men (75kg)	RED	CAVALLARO Salvatore	ITA
				BLU	KNEZEVIC Petar Kresimir	CRO
11	11	Round of 16	Men (75kg)	RED	TOUATI Mohamed Aziz	TUN
				BLU	AMROUG Zine Elabidine	MAR
12	12	Round of 16	Men (75kg)	RED	NEMOUCHI Younes	ALG
				BLU	CUADRADO ENTRENA Miguel	ESP
13	13	Round of 16	Men (75kg)	RED	CVITANOVIC Leo	BIH
				BLU	GULER Serhat	TUR



## Competition Officials

Function	Name	Country
Delegate	DRAGOLJUB RADOVIC	SRB - Serbia
Referee	LATIF DEMOLLI	KOS - Kosovo
	MUSTAFA OBEED	SYR - Syrian Arab Republic
	MARIA RIZZARDO	ITA - Italy
	ATHMANE LAZIZI	ALG - Algeria
	TOUMI MAHFAUD	ALG - Algeria
	SARA BOUHLEL	TUN - Tunisia
	HOUARI DERKAOUI	ALG - Algeria
	ZOHEIR GUENDOZ	ALG - Algeria
	SID ALI MOKRETARI	ALG - Algeria
	MOHAMED BESMI	ALG - Algeria





### Entry List by Country

Ctry	Name	Category	Date of Birth	Height m / ft	World Rank
<b>ALB</b>	<b>- Albania</b>				
	BEQIRI Alban	Men 69kg	28 JUN 1994	1.75 / 5' 9"	
	HYSA Nelson	Men +91kg	6 SEP 1984		
	KAJOSHI Arjon	Men 75kg	18 SEP 1996	1.82 / 6' 0"	
	MURJA Ardit	Men 57kg	18 MAR 1997	1.70 / 5' 7"	
<b>ALG</b>	<b>- Algeria</b>				
	ABDELKADER HEDJALA Fatma Zohra	Women 54kg	24 JUN 1992		
	BOUALAM Roumaysa	Women 48kg	7 FEB 2022	1.60 / 5' 3"	
	CHAIB Ichrak	Women 66kg	16 JAN 2001	1.75 / 5' 9"	
	KHELIF Hadjila	Women 60kg	1 SEP 1997	1.70 / 5' 7"	
	KHELIF Imane	Women 63kg	2 MAY 1999	1.78 / 5' 10"	
	MANSOURI Fatiha	Women 50kg	23 MAY 1997	1.73 / 5' 8"	
	ABDELLI Yahia	Men 63kg	16 SEP 1991	1.75 / 5' 9"	
	AIT-BEKKA Jugurtha	Men 69kg	4 MAR 1996	1.75 / 5' 9"	
	BENLARIBI Abdelnacer	Men 60kg	6 FEB 1995	1.80 / 5' 11"	
	BOULOU DINATS Chouaib	Men +91kg	8 JAN 1987		
	HAMANI Moh Said	Men 91kg	10 JUL 1997	1.80 / 5' 11"	
	HOU MRI Mohammed	Men 81kg	13 MAR 1993	1.80 / 5' 11"	
	MORDJANE Oussama	Men 57kg	17 NOV 1997	1.75 / 5' 9"	
	NEMOUCHI Younes	Men 75kg	16 SEP 1993	1.80 / 5' 11"	
	TOUAREG Mohamed Yassine	Men 52kg	15 AUG 1997		
<b>BIH</b>	<b>- Bosnia and Herzegovina</b>				
	BOHATJUK Tara	Women 63kg	28 AUG 2003	1.74 / 5' 9"	
	AGANOVIC Haris	Men 52kg	17 FEB 2002	1.70 / 5' 7"	
	BOSNJAK Dzemal	Men 91kg	23 MAY 1985	1.80 / 5' 11"	
	CVITANOVIC Leo	Men 75kg	22 AUG 2001	1.77 / 5' 10"	
	DANANOVIC Ahmed	Men 81kg	16 JUN 1995	1.85 / 6' 1"	
	DEDIC Gianni	Men 69kg	15 AUG 2001	1.75 / 5' 9"	
	IVKOVIC Nikola	Men 60kg	31 JUL 1991	1.70 / 5' 7"	
	RAHIMIC Alen	Men 57kg	24 APR 1998	1.80 / 5' 11"	
	VELJOVIC Luka	Men 63kg	4 AUG 2002	1.80 / 5' 11"	
<b>CRO</b>	<b>- Croatia</b>				
	CACIC Nikolina	Women 54kg	4 JAN 2001	1.70 / 5' 7"	
	JEZEK Noa	Men 69kg	5 APR 2001	1.80 / 5' 11"	



## Entry List by Country

Ctry	Name	Category	Date of Birth	Height m / ft	World Rank
	KNEZEVIC Petar Kresimir	Men 75kg	29 DEC 2003	1.83 / 6' 0"	
	PLANTIC Damir	Men 81kg	16 DEC 1989	1.80 / 5' 11"	
<b>CYP</b>	<b>- Cyprus</b>				
	CHRISTODOULOU Alexandros	Men 63kg	5 SEP 1999	1.68 / 5' 6"	
	PAFIOS Rafail	Men 69kg	25 AUG 1998	1.86 / 6' 1"	
<b>EGY</b>	<b>- Egypt</b>				
	AYYAD Yomna	Women 54kg	29 JUN 2003	1.69 / 5' 7"	
	HUSSEIN Mariam	Women 60kg	1 OCT 2003	1.75 / 5' 9"	
	KHALED Arwa	Women 66kg	26 DEC 1996	1.73 / 5' 8"	
	MOHAMED Eman	Women 50kg	10 JUN 1996	1.56 / 5' 1"	
	MOHAMED Rahma	Women 63kg	18 MAR 2002	1.69 / 5' 7"	
	YOUSSEF Salma	Women 48kg	13 AUG 1999	1.56 / 5' 1"	
	ABDALLA Aly	Men 75kg	30 NOV 2001	1.78 / 5' 10"	
	ABDELGAWWAD Abdelrahman	Men 81kg	9 OCT 1987	1.79 / 5' 10"	
	ABOZAID Omar	Men 57kg	7 DEC 2002	1.73 / 5' 8"	
	AMEN Essam	Men 63kg	18 SEP 1999	1.76 / 5' 9"	
	ELSAYED Omar	Men 69kg	14 AUG 2000	1.72 / 5' 8"	
	HAFEZ Yousry	Men +91kg	30 AUG 1993	1.94 / 6' 4"	
	IBRAHIM Mohamed	Men 91kg	25 JUN 2001	1.79 / 5' 10"	
	ISMAIL Ahmed	Men 52kg	30 NOV 1999		
	KOMSAN Mostfaa	Men 60kg	1 MAR 2000	1.70 / 5' 7"	
<b>ESP</b>	<b>- Spain</b>				
	FUERTES FERNANDEZ Laura	Women 50kg	29 APR 1999	1.63 / 5' 4"	
	LOPEZ DEL ARBOL Marta	Women 48kg	29 AUG 2000	1.60 / 5' 3"	
	MADUENO CONDE Maria Del Carmen	Women 54kg	27 OCT 1997	1.68 / 5' 6"	
	BARRUL FERNANDEZ Antonio	Men 57kg	11 FEB 1999	1.73 / 5' 8"	
	CUADRADO ENTRENA Miguel	Men 75kg	1 JUL 1994	1.84 / 6' 0"	
	JALIDOV GAFUROVA Gazimagomed	Men 81kg	16 MAR 1995	1.85 / 6' 1"	
	MOLINA SALVADOR Martin	Men 52kg	2 NOV 1994	1.59 / 5' 3"	
	QUILES BROTONS Jose	Men 60kg	19 OCT 1997	1.72 / 5' 8"	
	REYES PLA Enmanuel	Men 91kg	14 DEC 1992	1.90 / 6' 3"	
<b>FRA</b>	<b>- France</b>				
	BENMESSAHEL Fatia, Lamia	Women 66kg	21 AUG 1999	1.76 / 5' 9"	
	FRIGA Salma	Women 54kg	2 OCT 2001	1.62 / 5' 4"	
	LARCHE Thais, Alice	Women 63kg	26 MAY 2001	1.72 / 5' 8"	



## Entry List by Country

Ctry	Name	Category	Date of Birth	Height m / ft	World Rank
	MOULAI Romane	Women 50kg	29 JUL 1999	1.59 / 5' 3"	
	ZIDANI Amina	Women 60kg	23 AUG 1993		
	ABOUDOU MOINDZE Djamil-dini	Men +91kg	16 FEB 1996	1.81 / 5' 11"	
	BOUAFIA Soheb, Youcef	Men 91kg	1 FEB 1998	1.94 / 6' 4"	
	BOUKEDIM Ibrahim	Men 52kg	2 NOV 2001	1.70 / 5' 7"	
	FENDERO Moreno	Men 75kg	31 MAY 1999	1.75 / 5' 9"	
	GRAU Enzo, Claude, Michel	Men 60kg	9 OCT 1999	1.80 / 5' 11"	
	GRAU Hugo Fernand Robert	Men 69kg	7 APR 2001	1.90 / 6' 3"	
	KONE Cheikhmar	Men 81kg	2 DEC 2001	1.85 / 6' 1"	
<b>GRE</b>	<b>- Greece</b>				
	PAPADATOU Olga Pavlina	Women 60kg	3 FEB 1992	1.63 / 5' 4"	
	NANITZANIAN Vagkan	Men 91kg	8 AUG 1999	1.87 / 6' 2"	
<b>ITA</b>	<b>- Italy</b>				
	BONATTI Roberta	Women 48kg	5 JUL 1997		
	CANFORA Assunta	Women 63kg	11 JUL 1992		
	CHARAABI Sirine	Women 54kg	7 MAY 1999		
	GEMINI Melissa	Women 66kg	8 JUN 2002		
	NICOLI Rebecca	Women 60kg	29 SEP 1999		
	SORRENTINO Giordana	Women 50kg	27 APR 2000		
	CANONICO Giuseppe	Men 60kg	17 FEB 1996		
	CAVALLARO Salvatore	Men 75kg	16 AUG 1995		
	CAVALLARO Salvatore	Men 69kg	26 NOV 2001		
	COMMEY Alfred Cromwell	Men 81kg	19 OCT 2001		
	FIASCHETTI Vincenzo	Men +91kg	16 FEB 2001		
	IOZIA Francesco	Men 57kg	21 FEB 1998		
	MALANGA Gianluigi	Men 63kg	13 DEC 1999		
	MOUHIIDINE Aziz Abbes	Men 91kg	6 OCT 1998		
	SERRA Federico Emilio	Men 52kg	28 MAY 1994		
<b>KOS</b>	<b>- Kosovo</b>				
	BAJOKU Bashkim	Men 52kg	12 MAR 2001	1.71 / 5' 7"	
	BAJOKU Shpetim	Men 63kg	10 AUG 2000	1.76 / 5' 9"	
	BEHRAMI Patriot	Men 69kg	28 JUL 1999	1.75 / 5' 9"	
	MURATI Lorent	Men 57kg	17 JAN 2003	1.68 / 5' 6"	
<b>LBA</b>	<b>- Libya</b>				



## Entry List by Country

Ctry	Name	Category	Date of Birth	Height m / ft	World Rank
	ALI Ibrahim	Men 69kg	18 DEC 1998	1.76 / 5' 9"	
	DAWKU Asim	Men 75kg	21 DEC 1999	1.70 / 5' 7"	
<b>LBN</b>	<b>- Lebanon</b>				
	KHATOUN Zeinab	Women 54kg	27 AUG 1983		
	HASHEM Ali	Men 75kg	26 SEP 2001		
<b>MAR</b>	<b>- Morocco</b>				
	BEL AHBIB Oumayma	Women 66kg	21 AUG 1996	1.70 / 5' 7"	
	BERTAL Widad	Women 54kg	31 AUG 1999	1.70 / 5' 7"	
	MOUTTAKI Yasmine	Women 48kg	22 JUN 1997	1.70 / 5' 7"	
	RHADDI Chaymae	Women 60kg	12 OCT 1997	1.58 / 5' 2"	
	AMROUG Zine Elabidine	Men 75kg	4 OCT 1998	1.70 / 5' 7"	
	ASSAGHIR Mohamed	Men 81kg	27 MAY 1993	1.70 / 5' 7"	
	EL BARBARI Hamza	Men 69kg	6 JUL 1993	1.70 / 5' 7"	
	FIRISSE Mohamed	Men +91kg	20 AUG 1994	1.70 / 5' 7"	
	HAMOUT Mohamed	Men 60kg	11 DEC 1993	1.70 / 5' 7"	
	MORTAJI Said	Men 52kg	8 FEB 1997	1.60 / 5' 3"	
	NADIR Abdelhaq	Men 63kg	15 JUN 1993	1.70 / 5' 7"	
	ZOUHAIRI Abdellatif	Men 57kg	30 MAY 1995	1.70 / 5' 7"	
<b>MNE</b>	<b>- Montenegro</b>				
	GOJKOVIC Bojana	Women 54kg	2 AUG 2003	1.57 / 5' 2"	
	MARCIC Petar	Men 81kg	25 AUG 1998	1.73 / 5' 8"	
	SAVKOVIC Stefan	Men 69kg	12 MAR 2000	1.82 / 6' 0"	
<b>SLO</b>	<b>- Slovenia</b>				
	CERNOGA Tadej	Men 60kg	22 DEC 1995	1.78 / 5' 10"	
	NIKOLOV-VEBER Nik	Men 63kg	20 NOV 2000	1.85 / 6' 1"	
<b>SRB</b>	<b>- Serbia</b>				
	GAJIC Nikolina	Women 66kg	10 JUL 2000	1.68 / 5' 6"	
	ALICIC Semiz	Men 63kg	27 NOV 2002	1.75 / 5' 9"	
	AMETOVIC Omer	Men 52kg	8 MAR 2002	1.80 / 5' 11"	
	MEMIC Almir	Men 75kg	22 FEB 2002	1.68 / 5' 6"	
	MIRONCHIKOV Vladimir	Men 81kg	30 SEP 1998	1.78 / 5' 10"	
	SEJDI Nazif	Men 60kg	10 SEP 2002	1.80 / 5' 11"	
<b>SYR</b>	<b>- Syrian Arab Republic</b>				



## Entry List by Country

Ctry	Name	Category	Date of Birth	Height m / ft	World Rank
	GHOUSOON Ahmad	Men 75kg	4 SEP 1996	1.75 / 5' 9"	
	GHOUSOON Alaa Eldin	Men 91kg	10 DEC 1992	1.85 / 6' 1"	
	JOUKHDAR Belal	Men 57kg	3 JAN 1999	1.67 / 5' 6"	
	MLAIYES Mohammad	Men +91kg	5 APR 1993	1.80 / 5' 11"	
	NAKKASH Abdulhadi	Men 69kg	10 AUG 2002	1.75 / 5' 9"	
	YOUSSEF Abd Alhameed	Men 81kg	13 MAR 2000	1.82 / 6' 0"	
<b>TUN</b>	<b>- Tunisia</b>				
	CHEBBI Amel	Women 54kg	1 OCT 1996	1.65 / 5' 5"	
	HAFSI Wafa	Women 48kg	29 FEB 1996	1.56 / 5' 1"	
	HOMRANI EP ZAYANI Mariem	Women 60kg	25 JAN 1991	1.66 / 5' 5"	
	HAJRI Mehdi	Men 52kg	22 APR 1988	1.65 / 5' 5"	
	MHAMDI Bilel	Men 57kg	27 JAN 1992	1.73 / 5' 8"	
	SASSI Abdesalem	Men 63kg	7 JUL 2001	1.73 / 5' 8"	
	TOUATI Mohamed Aziz	Men 75kg	2 APR 2000	1.81 / 5' 11"	
<b>TUR</b>	<b>- Turkey</b>				
	AKBAS Hatice	Women 54kg	24 JUN 2001		
	CAGIRIR Ayse	Women 48kg	1 DEC 1995		
	CAKIROGLU Buse Naz	Women 50kg	26 MAY 1996		
	OZER Gizem	Women 63kg	9 APR 2001		
	SURMENELI Busenaz	Women 66kg	26 MAY 1998		
	AKSIN Burak	Men 91kg	20 OCT 2021		
	AYDEMIR Ugur	Men +91kg	10 JUN 2001		
	AYKUTSUN Kaan	Men 81kg	22 JUL 2002		
	CIFTCI Batuhan	Men 57kg	16 DEC 1997		
	DOGAN Hakan	Men 60kg	1 NOV 1995		
	EKINCI Necat	Men 69kg	20 OCT 1999		
	GULER Serhat	Men 75kg	2 JUL 1996		
	GUMUS Samet	Men 52kg	9 MAY 2001		
	OZMEN Kerem	Men 63kg	1 OCT 2002		



## Number of Entries by Country

As of MON 27 JUN 2022

Code	Country	Total entries by weight category									Total Athletes
		-52	-57	-60	-63	-69	-75	-81	-91	91	
ALB	Albania		1			1	1			1	4
ALG	Algeria	1	1	1	1	1	1	1	1	1	9
BIH	Bosnia and Herzegovina	1	1	1	1	1	1	1	1		8
CRO	Croatia					1	1	1			3
CYP	Cyprus				1	1					2
EGY	Egypt	1	1	1	1	1	1	1	1	1	9
ESP	Spain	1	1	1			1	1	1		6
FRA	France	1		1		1	1	1	1	1	7
GRE	Greece								1		1
ITA	Italy	1	1	1	1	1	1	1	1	1	9
KOS	Kosovo	1	1		1	1					4
LBA	Libya					1	1				2
LBN	Lebanon						1				1
MAR	Morocco	1	1	1	1	1	1	1		1	8
MNE	Montenegro					1		1			2
SLO	Slovenia			1	1						2
SRB	Serbia	1		1	1		1	1			5
SYR	Syrian Arab Republic		1			1	1	1	1	1	6
TUN	Tunisia	1	1		1		1				4
TUR	Turkey	1	1	1	1	1	1	1	1	1	9
	Total: 20	11	11	10	11	14	15	12	9	8	101



## Number of Entries by Country

As of MON 27 JUN 2022

Code	Country	Total entries by weight category						Total Athletes
		-48	-50	-54	-60	-63	-66	
ALG	Algeria	1	1	1	1	1	1	6
BIH	Bosnia and Herzegovina					1		1
CRO	Croatia			1				1
EGY	Egypt	1	1	1	1	1	1	6
ESP	Spain	1	1	1				3
FRA	France		1	1	1	1	1	5
GRE	Greece				1			1
ITA	Italy	1	1	1	1	1	1	6
LBN	Lebanon			1				1
MAR	Morocco	1		1	1		1	4
MNE	Montenegro			1				1
SRB	Serbia						1	1
TUN	Tunisia	1		1	1			3
TUR	Turkey	1	1	1		1	1	5
	Total: 14	7	6	11	7	6	7	44



## Medallists by Event

### After 15 of 15 Events

Event	Date	Medal	Name	Country Code
Women 48kg	FRI 1 JUL 2022	GOLD	BOUALAM Roumaysa	ALG
		SILVER	CAGIRIR Ayse	TUR
		BRONZE	LOPEZ DEL ARBOL Marta	ESP
		BRONZE	HAFSI Wafa	TUN
Women 50kg	FRI 1 JUL 2022	GOLD	SORRENTINO Giordana	ITA
		SILVER	MOULAI Romane	FRA
		BRONZE	FUERTES FERNANDEZ Laura	ESP
		BRONZE	CAKIROGLU Buse Naz	TUR
Women 54kg	FRI 1 JUL 2022	GOLD	AKBAS Hatice	TUR
		SILVER	GOJKOVIC Bojana	MNE
		BRONZE	AYYAD Yomna	EGY
		BRONZE	ABDELKADER HEDJALA Fatma Zohra	ALG
Women 60kg	FRI 1 JUL 2022	GOLD	KHELIF Hadjila	ALG
		SILVER	RHADDI Chaymae	MAR
		BRONZE	ZIDANI Amina	FRA
		BRONZE	NICOLI Rebecca	ITA
Women 63kg	FRI 1 JUL 2022	GOLD	KHELIF Imane	ALG
		SILVER	CANFORA Assunta	ITA
		BRONZE	OZER Gizem	TUR
		BRONZE	LARCHE Thais Alice	FRA
Women 66kg	FRI 1 JUL 2022	GOLD	SURMENELI Busenaz	TUR
		SILVER	CHAIB Ichrak	ALG
		BRONZE	GEMINI Melissa	ITA
		BRONZE	BEL AHBIB Oumayma	MAR
Men +91ka	FRI 1 JUL 2022	GOLD	HAFEZ Yousry	EGY
		SILVER	FIASCETTI Vincenzo	ITA
		BRONZE	BOULOU DINATS Chouaib	ALG
		BRONZE	ABOUDOU MOINDZE Djamil-dini	FRA
Men 52kg	FRI 1 JUL 2022	GOLD	SERRA Federico Emilio	ITA
		SILVER	MORTAJI Said	MAR
		BRONZE	GUMUS Samet	TUR
		BRONZE	AMETOVIC Omer	SRB
Men 57kg	FRI 1 JUL 2022	GOLD	CIFTCI Batahan	TUR
		SILVER	MORDJANE Oussama	ALG
		BRONZE	ZOUHAIRI Abdellatif	MAR
		BRONZE	MHAMDI Bilel	TUN
Men 60kg	FRI 1 JUL 2022	GOLD	HAMOUT Mohamed	MAR
		SILVER	GRAU Enzo, Claude, Michel	FRA
		BRONZE	CANONICO Giuseppe	ITA
		BRONZE	BENLARIBI Abdelnacer	ALG
Men 63kg	FRI 1 JUL 2022	GOLD	ABDELLI Yahia	ALG
		SILVER	MALANGA Gianluigi	ITA
		BRONZE	BAJOKU Shpetim	KOS
		BRONZE	NADIR Abdelhaq	MAR





## Medallists by Event

### After 15 of 15 Events

Event	Date	Medal	Name	Country Code
Men 69kg	FRI 1 JUL 2022	GOLD	AIT-BEKKA Juqurtha	ALG
		SILVER	SAVKOVIC Stefan	MNE
		BRONZE	EL BARBARI Hamza	MAR
		BRONZE	ELSAYED Omar	EGY
Men 75kg	FRI 1 JUL 2022	GOLD	GHOUSOON Ahmad	SYR
		SILVER	NEMOUCHI Younes	ALG
		BRONZE	FENDERO Moreno	FRA
		BRONZE	CAVALLARO Salvatore	ITA
Men 81kg	FRI 1 JUL 2022	GOLD	MIRONCHIKOV Vladimir	SRB
		SILVER	HOUMRI Mohammed	ALG
		BRONZE	JALIDOV GAFUROVA Gazimaqomed	ESP
		BRONZE	MARCIC Petar	MNE
Men 91kg	FRI 1 JUL 2022	GOLD	MOUHIIDINE Aziz Abbas	ITA
		SILVER	HAMANI Moh Said	ALG
		BRONZE	NANITZANIAN Vaqkan	GRE
		BRONZE	BOUAFIA Soheb, Youcef	FRA



## Medal Standings

After 15 of 15 Events

Rank	Country	Men				Women				Total				Rank by total
		G	S	B	Tot	G	S	B	Tot	G	S	B	Tot	
1	ALG - Algeria	2	4	2	8	3	1	1	5	5	5	3	13	1
2	ITA - Italy	2	2	2	6	1	1	2	4	3	3	4	10	2
3	TUR - Turkiye	1		1	2	2	1	2	5	3	1	3	7	=3
4	MAR - Morocco	1	1	3	5		1	1	2	1	2	4	7	=3
5	EGY - Egypt	1		1	2			1	1	1		2	3	=6
6	SRB - Serbia	1		1	2					1		1	2	=9
7	SYR - Syrian Arab Republic	1			1					1			1	=11
8	FRA - France		1	3	4		1	2	3		2	5	7	=3
9	MNE - Montenegro		1	1	2		1		1		2	1	3	=6
10	ESP - Spain			1	1			2	2			3	3	=6
11	TUN - Tunisia			1	1			1	1			2	2	=9
12	GRE - Greece			1	1							1	1	=11
12	KOS - Kosovo			1	1							1	1	=11
	<b>Total:</b>	<b>9</b>	<b>9</b>	<b>18</b>	<b>36</b>	<b>6</b>	<b>6</b>	<b>12</b>	<b>24</b>	<b>15</b>	<b>15</b>	<b>30</b>	<b>60</b>	

### LEGEND

- -  
- -



## Entry List by Event

Ctry	Name	Date of Birth	Height m / ft	World Rank
ALG - Algeria	TOUAREG Mohamed Yassine	15 AUG 1997		
BIH - Bosnia and Herzegovina	AGANOVIC Haris	17 FEB 2002	1.70 / 5' 7"	
EGY - Egypt	ISMAIL Ahmed	30 NOV 1999		
ESP - Spain	MOLINA SALVADOR Martin	2 NOV 1994	1.59 / 5' 3"	
FRA - France	BOUKEDIM Ibrahim	2 NOV 2001	1.70 / 5' 7"	
ITA - Italy	SERRA Federico Emilio	28 MAY 1994		
KOS - Kosovo	BAJOKU Bashkim	12 MAR 2001	1.71 / 5' 7"	
MAR - Morocco	MORTAJI Said	8 FEB 1997	1.60 / 5' 3"	
SRB - Serbia	AMETOVIC Omer	8 MAR 2002	1.80 / 5' 11"	
TUN - Tunisia	HAJRI Mehdi	22 APR 1988	1.65 / 5' 5"	
TUR - Turkey	GUMUS Samet	9 MAY 2001		

Total athletes: 11



### Competition Sheet

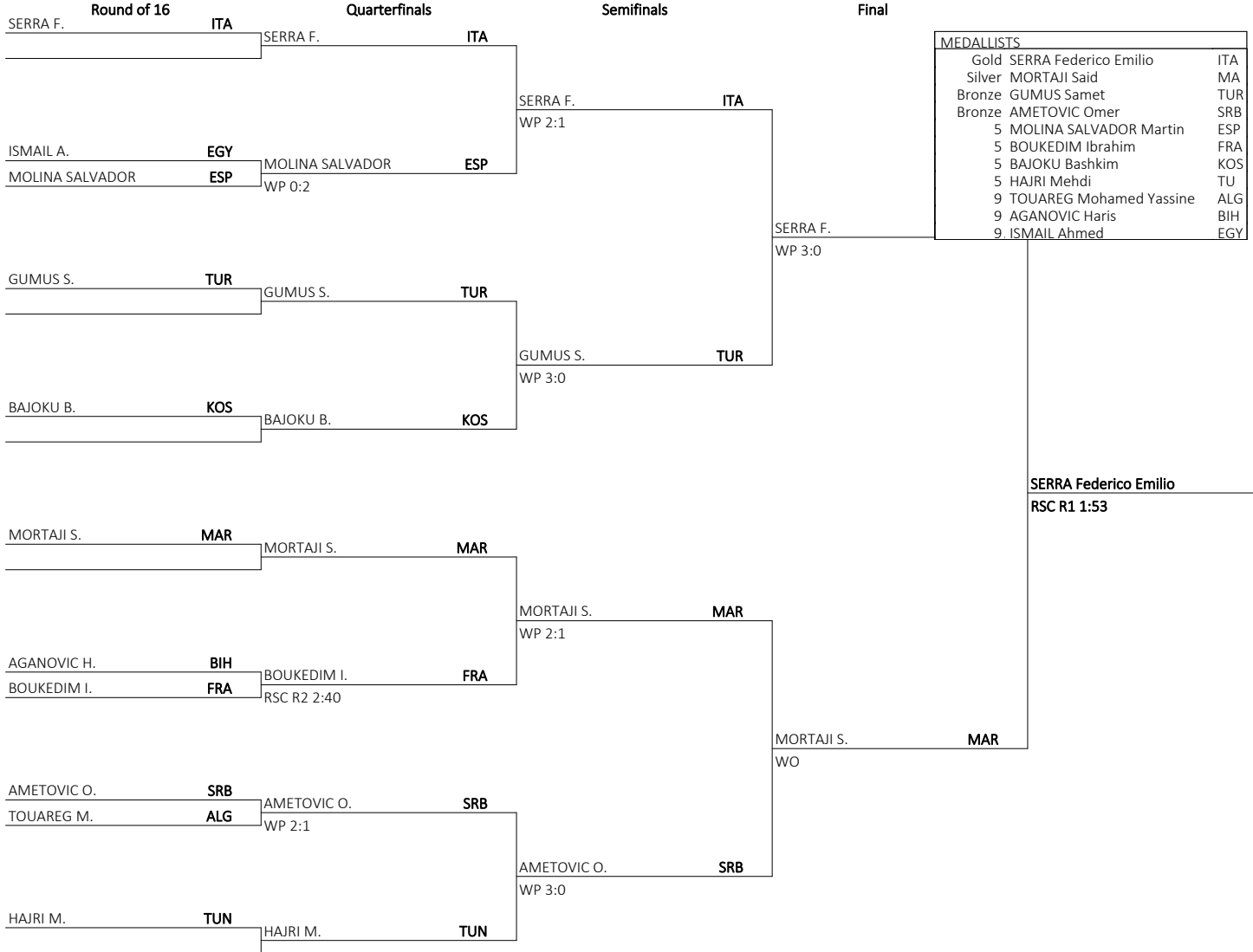



## Final Standings

Rank	Name	Country Cod
Gold	SERRA Federico Emilio	ITA
Silver	MORTAJI Said	MAR
Bronze	GUMUS Samet	TUR
Bronze	AMETOVIC Omer	SRB
5	MOLINA SALVADOR Martin	ESP
5	BOUKEDIM Ibrahim	FRA
5	BAJOKU Bashkim	KOS
5	HAJRI Mehdi	TUN
9	TOUAREG Mohamed Yassine	ALG
9	AGANOVIC Haris	BIH
9	ISMAIL Ahmed	EGY



## Entry List by Event

Ctry	Name	Date of Birth	Height m / ft	World Rank
ALB - Albania	MURJA Ardit	18 MAR 1997	1.70 / 5'7"	
ALG - Algeria	MORDJANE Oussama	17 NOV 1997	1.75 / 5'9"	
BIH - Bosnia and Herzegovina	RAHIMIC Alen	24 APR 1998	1.80 / 5'11"	
EGY - Egypt	ABOZAID Omar	7 DEC 2002	1.73 / 5'8"	
ESP - Spain	BARRUL FERNANDEZ Antonio	11 FEB 1999	1.73 / 5'8"	
ITA - Italy	IOZIA Francesco	21 FEB 1998		
KOS - Kosovo	MURATI Lorent	17 JAN 2003	1.68 / 5'6"	
MAR - Morocco	ZOUHAIRI Abdellatif	30 MAY 1995	1.70 / 5'7"	
SYR - Syrian Arab Republic	JOUKHDAR Belal	3 JAN 1999	1.67 / 5'6"	
TUN - Tunisia	MHAMDI Bilel	27 JAN 1992	1.73 / 5'8"	
TUR - Turkey	CIFTCI Batuhan	16 DEC 1997		

Total athletes: 11



## Competition Sheet

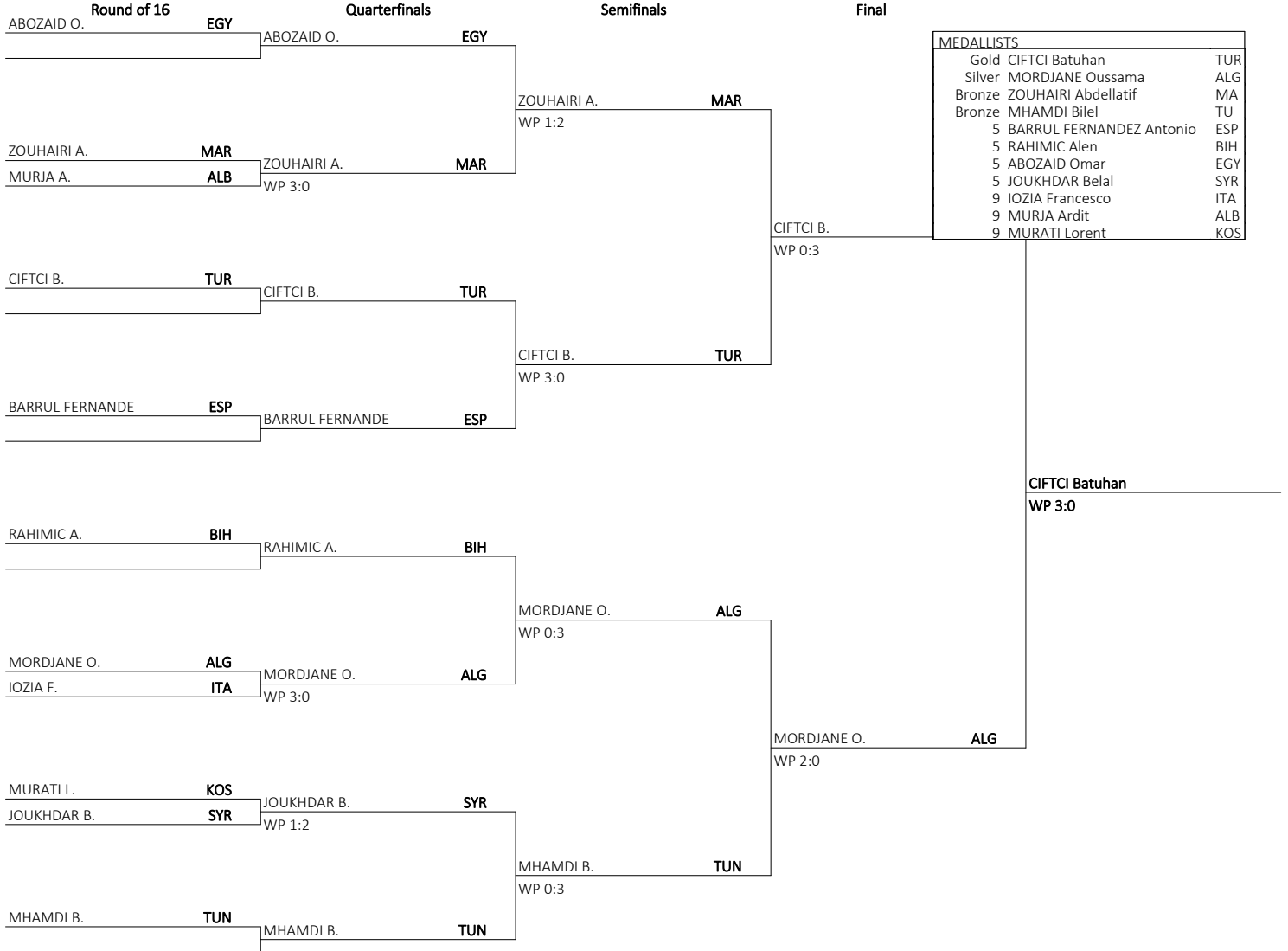



## Final Standings

Rank	Name	Country Cod
Gold	CIFTCI Batuhan	TUR
Silver	MORDJANE Oussama	ALG
Bronze	ZOUHAIRI Abdellatif	MAR
Bronze	MHAMDI Bilel	TUN
5	BARRUL FERNANDEZ Antonio	ESP
5	RAHIMIC Alen	BIH
5	ABOZAID Omar	EGY
5	JOUKHDAR Belal	SYR
9	IOZIA Francesco	ITA
9	MURJA Ardit	ALB
9	MURATI Lorent	KOS





## Entry List by Event

Ctry	Name	Date of Birth	Height m / ft	World Rank
ALG - Algeria	BENLARIBI Abdelnacer	6 FEB 1995	1.80 / 5' 11 "	
BIH - Bosnia and Herzegovina	IVKOVIC Nikola	31 JUL 1991	1.70 / 5' 7 "	
EGY - Egypt	KOMSAN Mostfaa	1 MAR 2000	1.70 / 5' 7 "	
ESP - Spain	QUILES BROTONS Jose	19 OCT 1997	1.72 / 5' 8 "	
FRA - France	GRAU Enzo, Claude, Michel	9 OCT 1999	1.80 / 5' 11 "	
ITA - Italy	CANONICO Giuseppe	17 FEB 1996		
MAR - Morocco	HAMOUT Mohamed	11 DEC 1993	1.70 / 5' 7 "	
SLO - Slovenia	CERNOGA Tadej	22 DEC 1995	1.78 / 5' 10 "	
SRB - Serbia	SEJDI Nazif	10 SEP 2002	1.80 / 5' 11 "	
TUR - Turkey	DOGAN Hakan	1 NOV 1995		

Total athletes: 10



## Competition Sheet

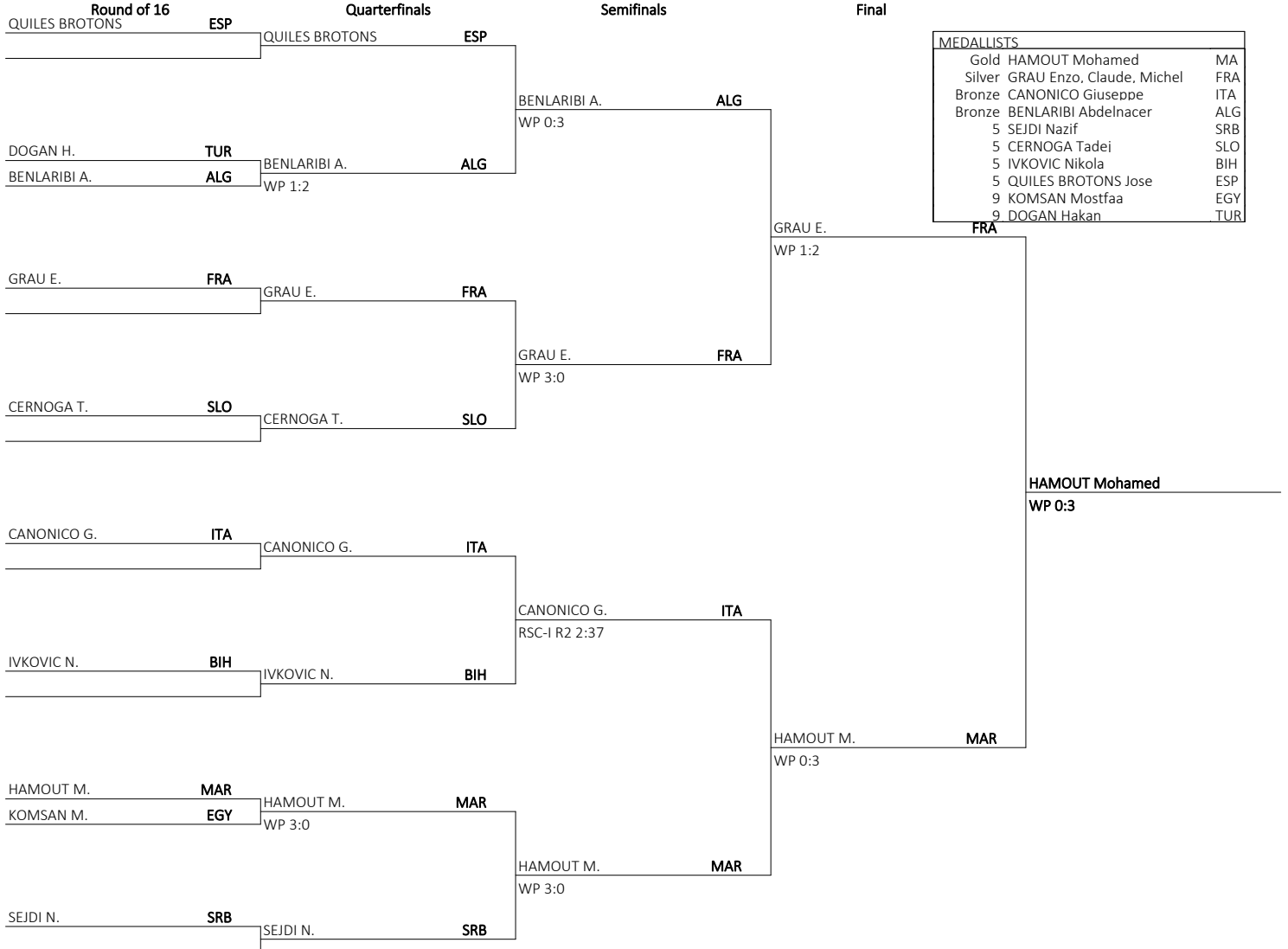



## Final Standings

Rank	Name	Country Cod
Gold	HAMOUT Mohamed	MAR
Silver	GRAU Enzo, Claude, Michel	FRA
Bronze	CANONICO Giuseppe	ITA
Bronze	BENLARIBI Abdelnacer	ALG
5	SEJDI Nazif	SRB
5	CERNOGA Tadej	SLO
5	IVKOVIC Nikola	BIH
5	QUILES BROTONS Jose	ESP
9	KOMSAN Mostfaa	EGY
9	DOGAN Hakan	TUR



## Entry List by Event

Ctry	Name	Date of Birth	Height m / ft	World Rank
ALG - Algeria	ABDELLI Yahia	16 SEP 1991	1.75 / 5' 9"	
BIH - Bosnia and Herzegovina	VELJOVIC Luka	4 AUG 2002	1.80 / 5' 11"	
CYP - Cyprus	CHRISTODOULOU Alexandros	5 SEP 1999	1.68 / 5' 6"	
EGY - Egypt	AMEN Essam	18 SEP 1999	1.76 / 5' 9"	
ITA - Italy	MALANGA Gianluigi	13 DEC 1999		
KOS - Kosovo	BAJOKU Shpetim	10 AUG 2000	1.76 / 5' 9"	
MAR - Morocco	NADIR Abdelhaq	15 JUN 1993	1.70 / 5' 7"	
SLO - Slovenia	NIKOLOV-VEBER Nik	20 NOV 2000	1.85 / 6' 1"	
SRB - Serbia	ALICIC Semiz	27 NOV 2002	1.75 / 5' 9"	
TUN - Tunisia	SASSI Abdesalem	7 JUL 2001	1.73 / 5' 8"	
TUR - Turkey	OZMEN Kerem	1 OCT 2002		

Total athletes: 11



## Competition Sheet

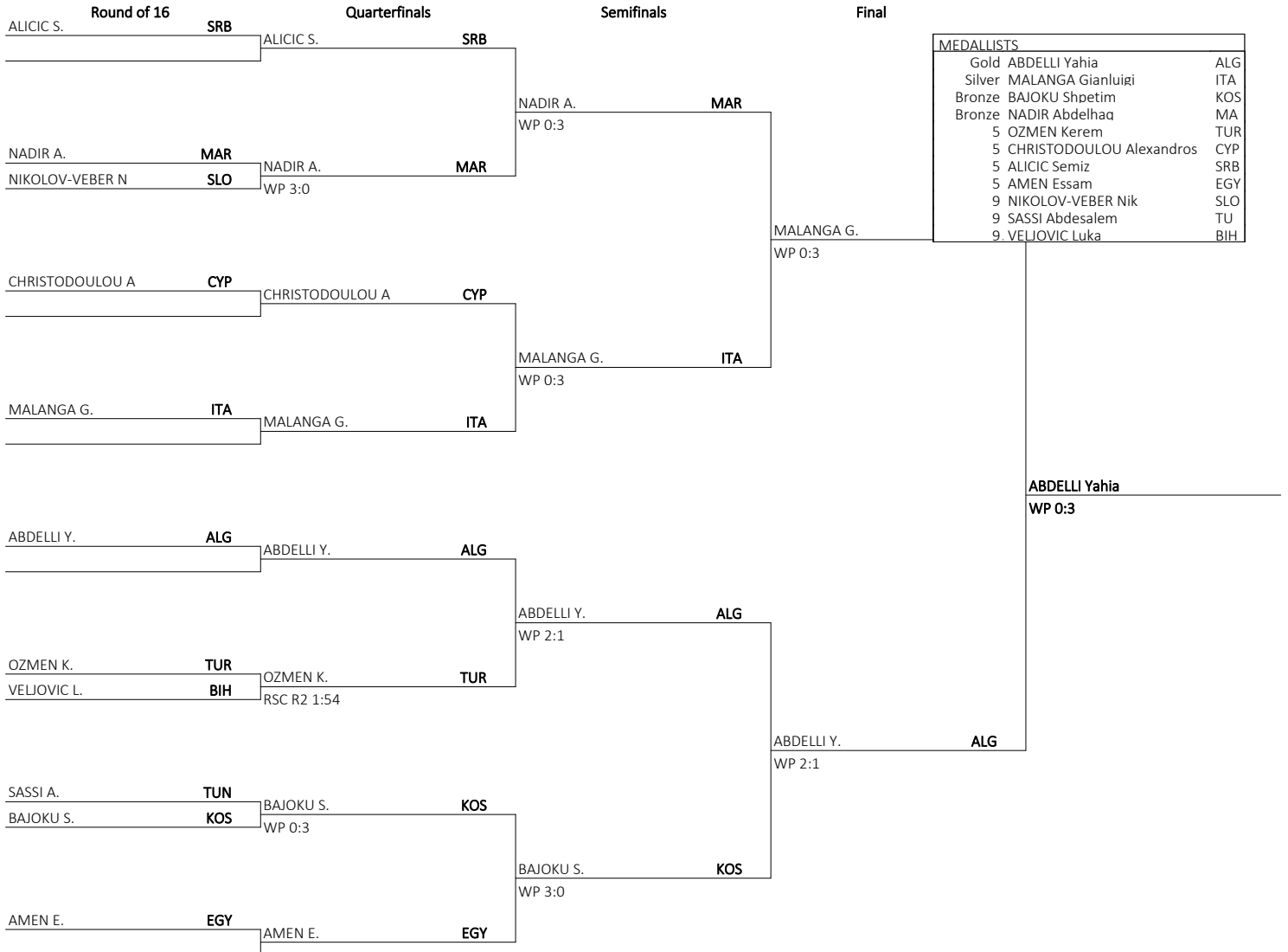



## Final Standings

Rank	Name	Country Cod
Gold	ABDELLI Yahia	ALG
Silver	MALANGA Gianluigi	ITA
Bronze	BAJOKU Shpetim	KOS
Bronze	NADIR Abdelhaq	MAR
5	OZMEN Kerem	TUR
5	CHRISTODOULOU Alexandros	CYP
5	ALICIC Semiz	SRB
5	AMEN Essam	EGY
9	NIKOLOV-VEBER Nik	SLO
9	SASSI Abdesalem	TUN
9	VELJOVIC Luka	BIH



## Entry List by Event

Ctry	Name	Date of Birth	Height m / ft	World Rank
ALB - Albania	BEQIRI Alban	28 JUN 1994	1.75 / 5'9"	
ALG - Algeria	AIT-BEKKA Jugurtha	4 MAR 1996	1.75 / 5'9"	
BIH - Bosnia and Herzegovina	DEDIC Gianni	15 AUG 2001	1.75 / 5'9"	
CRO - Croatia	JEZEK Noa	5 APR 2001	1.80 / 5'11"	
CYP - Cyprus	PAFIOS Rafail	25 AUG 1998	1.86 / 6'1"	
EGY - Egypt	ELSAYED Omar	14 AUG 2000	1.72 / 5'8"	
FRA - France	GRAU Hugo Fernand Robert	7 APR 2001	1.90 / 6'3"	
ITA - Italy	CAVALLARO Salvatore	26 NOV 2001		
KOS - Kosovo	BEHRAMI Patriot	28 JUL 1999	1.75 / 5'9"	
LBA - Libya	ALI Ibrahim	18 DEC 1998	1.76 / 5'9"	
MAR - Morocco	EL BARBARI Hamza	6 JUL 1993	1.70 / 5'7"	
MNE - Montenegro	SAVKOVIC Stefan	12 MAR 2000	1.82 / 6'0"	
SYR - Syrian Arab Republic	NAKKASH Abdulhadi	10 AUG 2002	1.75 / 5'9"	
TUR - Turkey	EKINCI Necat	20 OCT 1999		

Total athletes: 14



## Competition Sheet

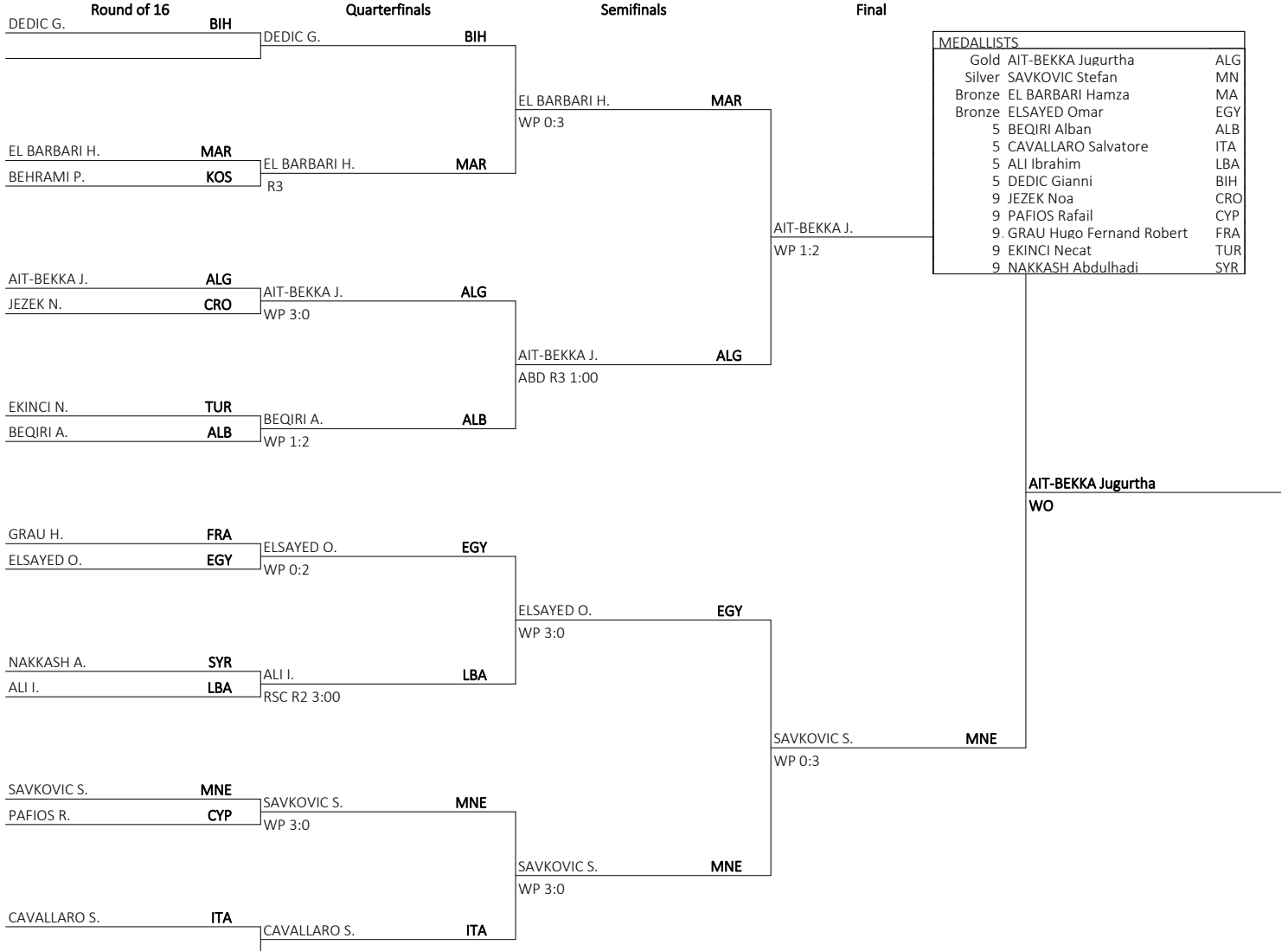





## Final Standings

Rank	Name	Country Cod
Gold	AIT-BEKKA Juqurtha	ALG
Silver	SAVKOVIC Stefan	MNE
Bronze	EL BARBARI Hamza	MAR
Bronze	ELSAYED Omar	EGY
5	BEQIRI Alban	ALB
5	CAVALLARO Salvatore	ITA
5	ALI Ibrahim	LBA
5	DEDIC Gianni	BIH
9	JEZEK Noa	CRO
9	PAFIOS Rafail	CYP
9	GRAU Hugo Fernand Robert	FRA
9	EKINCI Necat	TUR
9	NAKKASH Abdulhadi	SYR



## Entry List by Event

Ctry	Name	Date of Birth	Height m / ft	World Rank
ALB - Albania	KAJOSHI Arjon	18 SEP 1996	1.82 / 6' 0"	
ALG - Algeria	NEMOUCHI Younes	16 SEP 1993	1.80 / 5' 11"	
BIH - Bosnia and Herzegovina	CVITANOVIC Leo	22 AUG 2001	1.77 / 5' 10"	
CRO - Croatia	KNEZEVIC Petar Kresimir	29 DEC 2003	1.83 / 6' 0"	
EGY - Egypt	ABDALLA Aly	30 NOV 2001	1.78 / 5' 10"	
ESP - Spain	CUADRADO ENTRENA Miguel	1 JUL 1994	1.84 / 6' 0"	
FRA - France	FENDERO Moreno	31 MAY 1999	1.75 / 5' 9"	
ITA - Italy	CAVALLARO Salvatore	16 AUG 1995		
LBA - Libya	DAWKU Asim	21 DEC 1999	1.70 / 5' 7"	
LBN - Lebanon	HASHEM Ali	26 SEP 2001		
MAR - Morocco	AMROUG Zine Elabidine	4 OCT 1998	1.70 / 5' 7"	
SRB - Serbia	MEMIC Almir	22 FEB 2002	1.68 / 5' 6"	
SYR - Syrian Arab Republic	GHOUSOON Ahmad	4 SEP 1996	1.75 / 5' 9"	
TUN - Tunisia	TOUATI Mohamed Aziz	2 APR 2000	1.81 / 5' 11"	
TUR - Turkey	GULER Serhat	2 JUL 1996		

Total athletes: 15



## Competition Sheet

Round of 16		Quarterfinals		Semifinals		Final	
GHOUSOON A. SYR		GHOUSOON A. SYR		GHOUSOON A. SYR		GHOUSOON A. SYR	
				WP 2:1			
MEMIC A. SRB		MEMIC A. SRB					
HASHEM A. LBN		RSC R1 2:54					
FENDERO M. FRA		FENDERO M. FRA		FENDERO M. FRA			
KAJOSHI A. ALB		WP 3:0		WP 3:0			
DAWKU A. LBA		ABDALLA A. EGY					
ABDALLA A. EGY		WP 0:3					
CAVALLARO S. ITA		CAVALLARO S. ITA		CAVALLARO S. ITA			
KNEZEVIC P. CRO		WO		WP 2:1			
TOUATI M. TUN		AMROUG Z. MAR					
AMROUG Z. MAR		WP 0:3					
NEMOUCHI Y. ALG		NEMOUCHI Y. ALG		NEMOUCHI Y. ALG		NEMOUCHI Y. ALG	
CUADRADO ENTREN ESP		WP 3:0		WP 3:0		WP 1:2	
CVITANOVIC L. BIH		CVITANOVIC L. BIH					
GULER S. TUR		WP 3:0					

MEDALLISTS		
Gold	GHOUSOON Ahmad	SYR
Silver	NEMOUCHI Younes	ALG
Bronze	FENDERO Moreno	FRA
Bronze	CAVALLARO Salvatore	ITA
	5 MEMIC Almir	SRB
	5 CVITANOVIC Leo	BIH
	5 ABDALLA Alv	EGY
	5 AMROUG Zine Elabidine	MA
	9 CUADRADO ENTRENA Miguel	ESP
	9 KAJOSHI Arjon	ALB
	9 KNEZEVIC Petar Kresimir	CRO
	9 DAWKU Asim	LBA
	9 GULER Serhat	TUR
	9 HASHEM Ali	LBN
	9 TOUATI Mohamed Aziz	TU

<b>GHOUSOON Ahmad</b>
WP 2:1



## Final Standings

Rank	Name	Country Cod
Gold	GHOUSOON Ahmad	SYR
Silver	NEMOUCHI Younes	ALG
Bronze	FENDERO Moreno	FRA
Bronze	CAVALLARO Salvatore	ITA
5	MEMIC Almir	SRB
5	CVITANOVIC Leo	BIH
5	ABDALLA Aly	EGY
5	AMROUG Zine Elabidine	MAR
9	CUADRADO ENTRENA Miquel	ESP
9	KAJOSHI Arion	ALB
9	KNEZEVIC Petar Kresimir	CRO
9	DAWKU Asim	LBA
9	GULER Serhat	TUR
9	HASHEM Ali	LBN
9	TOUATI Mohamed Aziz	TUN



## Entry List by Event

Ctry	Name	Date of Birth	Height m / ft	World Rank
ALG - Algeria	HOUMRI Mohammed	13 MAR 1993	1.80 / 5' 11"	
BIH - Bosnia and Herzegovina	DANANOVIC Ahmed	16 JUN 1995	1.85 / 6' 1"	
CRO - Croatia	PLANTIC Damir	16 DEC 1989	1.80 / 5' 11"	
EGY - Egypt	ABDELGAWWAD Abdelrahman	9 OCT 1987	1.79 / 5' 10"	
ESP - Spain	JALIDOV GAFUROVA Gazimagomed	16 MAR 1995	1.85 / 6' 1"	
FRA - France	KONE Cheikhmar	2 DEC 2001	1.85 / 6' 1"	
ITA - Italy	COMMEY Alfred Cromwell	19 OCT 2001		
MAR - Morocco	ASSAGHIR Mohamed	27 MAY 1993	1.70 / 5' 7"	
MNE - Montenegro	MARCIC Petar	25 AUG 1998	1.73 / 5' 8"	
SRB - Serbia	MIRONCHIKOV Vladimir	30 SEP 1998	1.78 / 5' 10"	
SYR - Syrian Arab Republic	YOUSSEF Abd Alhameed	13 MAR 2000	1.82 / 6' 0"	
TUR - Turkey	AYKUTSUN Kaan	22 JUL 2002		

Total athletes: 12



## Competition Sheet

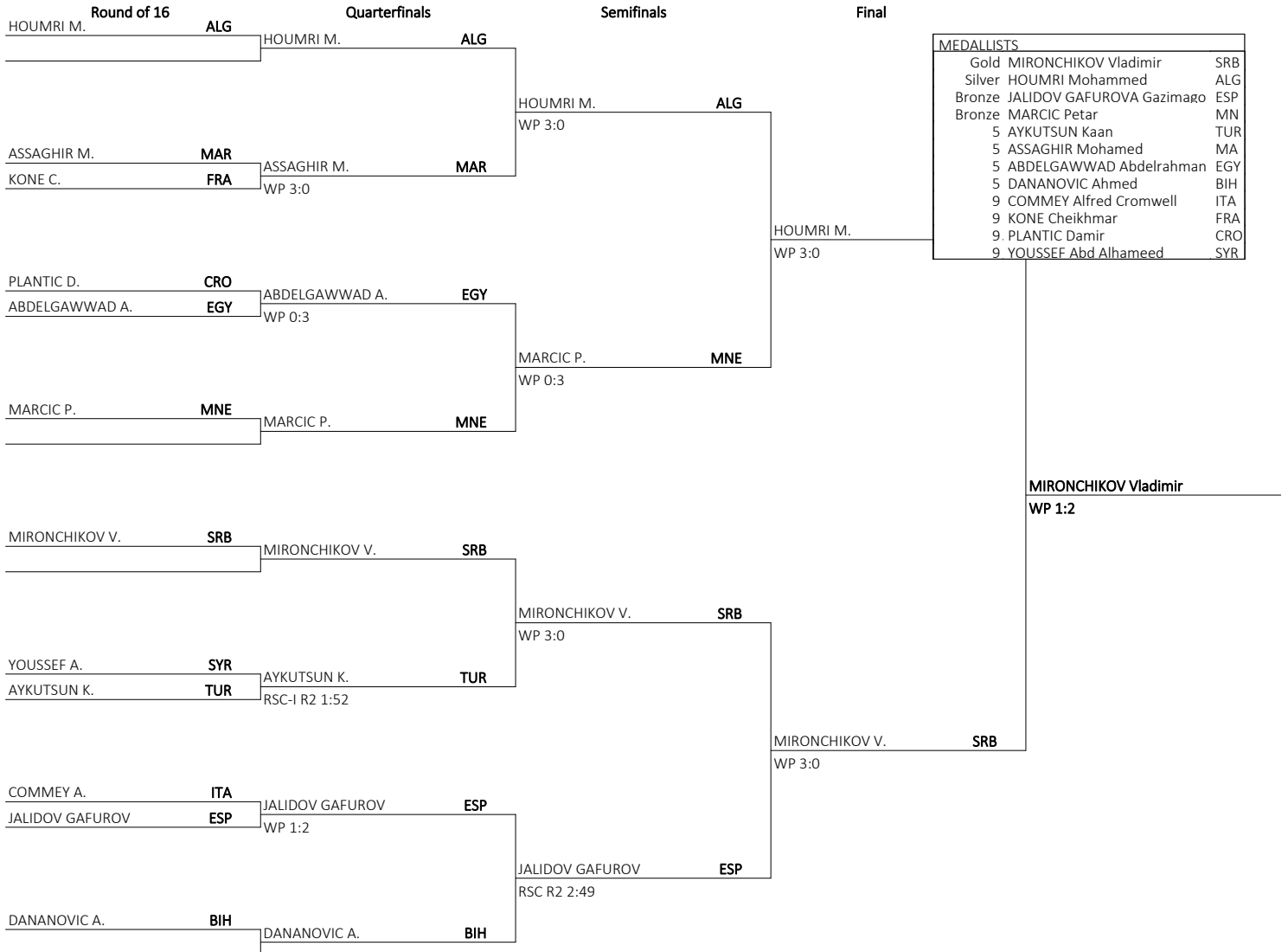



## Final Standings

Rank	Name	Country Cod
Gold	MIRONCHIKOV Vladimir	SRB
Silver	HOUMRI Mohammed	ALG
Bronze	JALIDOV GAFUROVA Gazimaqomed	ESP
Bronze	MARCIC Petar	MNE
5	AYKUTSUN Kaan	TUR
5	ASSAGHIR Mohamed	MAR
5	ABDELGAWWAD Abdelrahman	EGY
5	DANANOVIC Ahmed	BIH
9	COMMEY Alfred Cromwell	ITA
9	KONE Cheikhmar	FRA
9	PLANTIC Damir	CRO
9	YOUSSEF Abd Alhameed	SYR



## Entry List by Event

Ctry	Name	Date of Birth	Height m / ft	World Rank
ALG - Algeria	HAMANI Moh Said	10 JUL 1997	1.80 / 5' 11"	
BIH - Bosnia and Herzegovina	BOSNJAK Dzemal	23 MAY 1985	1.80 / 5' 11"	
EGY - Egypt	IBRAHIM Mohamed	25 JUN 2001	1.79 / 5' 10"	
ESP - Spain	REYES PLA Enmanuel	14 DEC 1992	1.90 / 6' 3"	
FRA - France	BOUAFIA Soheb, Youcef	1 FEB 1998	1.94 / 6' 4"	
GRE - Greece	NANITZANIAN Vagkan	8 AUG 1999	1.87 / 6' 2"	
ITA - Italy	MOUHIIDINE Aziz Abbes	6 OCT 1998		
SYR - Syrian Arab Republic	GHOUSOON Alaa Eldin	10 DEC 1992	1.85 / 6' 1"	
TUR - Turkey	AKSIN Burak	20 OCT 2021		

Total athletes: 9





## Competition Sheet

Round of 16		Quarterfinals		Semifinals		Final	
BOSNJAK D.	BIH	BOSNJAK D.	BIH	BOUAFIA S.	FRA	HAMANI M.	ALG
AKSIN B.	TUR	BOUAFIA S.	FRA	WP 0:2		WP 0:3	
BOUAFIA S.	FRA	WP 0:3					
HAMANI M.	ALG	HAMANI M.	ALG	HAMANI M.	ALG		
				WP 2:1			
GHOUSOON A.	SYR	GHOUSOON A.	SYR				
IBRAHIM M.	EGY	IBRAHIM M.	EGY	NANITZANIAN V.	GRE	MOUHIIDINE A.	ITA
				WP 0:3		WP 0:3	
NANITZANIAN V.	GRE	NANITZANIAN V.	GRE				
REYES PLA E.	ESP	REYES PLA E.	ESP	MOUHIIDINE A.	ITA		
				WP 0:3			
MOUHIIDINE A.	ITA	MOUHIIDINE A.	ITA				

MEDALLISTS		
Gold	MOUHIIDINE Aziz Abbes	ITA
Silver	HAMANI Moh Said	ALG
Bronze	NANITZANIAN Vagkan	GRE
Bronze	BOUAFIA Soheb, Youcef	FRA
	5 REYES PLA Emmanuel	ESP
	5 GHOUSOON Alaa Eldin	SYR
	5 BOSNJAK Dzermal	BIH
	5 IBRAHIM Mohamed	EGY
	9 AKSIN Burak	TUR

MOUHIIDINE Aziz Abbes
WP 0:3



## Final Standings

Rank	Name	Country Cod
Gold	MOUHIIDINE Aziz Abbes	ITA
Silver	HAMANI Moh Said	ALG
Bronze	NANITZANIAN Vagkan	GRE
Bronze	BOUAFIA Soheb, Youcef	FRA
5	REYES PLA Enmanuel	ESP
5	GHOUSOON Alaa Eldin	SYR
5	BOSNJAK Dzemal	BIH
5	IBRAHIM Mohamed	EGY
9	AKSIN Burak	TUR



## Entry List by Event

Ctry	Name	Date of Birth	Height m / ft	World Rank
ALB - Albania	HYSA Nelson	6 SEP 1984		
ALG - Algeria	BOULOU DINATS Chouaib	8 JAN 1987		
EGY - Egypt	HAFEZ Yousry	30 AUG 1993	1.94 / 6' 4"	
FRA - France	ABOUDOU MOINDZE Djamili-dini	16 FEB 1996	1.81 / 5' 11"	
ITA - Italy	FIASCHETTI Vincenzo	16 FEB 2001		
MAR - Morocco	FIRISSE Mohamed	20 AUG 1994	1.70 / 5' 7"	
SYR - Syrian Arab Republic	MLAIYES Mohammad	5 APR 1993	1.80 / 5' 11"	
TUR - Turkey	AYDEMIR Ugur	10 JUN 2001		

Total athletes: 8



## Competition Sheet

Quarterfinals		Semifinals		Final		MEDALLISTS		
FIRISSE M.	MAR	HAFEZ Y.	EGY	HAFEZ Y.	EGY	Gold	HAFEZ Yousvy	EGY
HAFEZ Y.	EGY	WP 0:3		WP 3:0		Silver	FIASCHETTI Vincenzo	ITA
AYDEMIR U.	TUR	BOULODINATS C.	ALG	FIASCHETTI V.	ITA	Bronze	BOULODINATS Chouaib	ALG
BOULODINATS C.	ALG	WP 0:2		WP 0:3		Bronze	ABOUDOU MOINDZE Diamili-di	FRA
ABOUDOU MOINDZE	FRA	ABOUDOU MOINDZE	FRA	WP 0:3		5	FIRISSE Mohamed	MA
MLAIYES M.	SYR	WP 3:0		WP 1:2		5	HYSA Nelson	ALB
HYSA N.	ALB	FIASCHETTI V.	ITA	WP 3:0		5	AYDEMIR Uğur	TUR
FIASCHETTI V.	ITA	WP 1:2		WP 2:1		5	MLAIYES Mohammad	SYR
						HAFEZ Yousvy WP 2:1		



## Final Standings

Rank	Name	Country Cod
Gold	HAFEZ Yousry	EGY
Silver	FIASCHETTI Vincenzo	ITA
Bronze	BOULODINATS Chouaib	ALG
Bronze	ABOUDOU MOINDZE Diamili-dini	FRA
5	FIRISSE Mohamed	MAR
5	HYSA Nelson	ALB
5	AYDEMIR Uqur	TUR
5	MLAIYES Mohammad	SYR



## Entry List by Event

Ctry	Name	Date of Birth	Height m / ft	World Rank
ALG - Algeria	BOUALAM Roumaysa	7 FEB 2022	1.60 / 5'3"	
EGY - Egypt	YOUSSEF Salma	13 AUG 1999	1.56 / 5'1"	
ESP - Spain	LOPEZ DEL ARBOL Marta	29 AUG 2000	1.60 / 5'3"	
ITA - Italy	BONATTI Roberta	5 JUL 1997		
MAR - Morocco	MOUTTAKI Yasmine	22 JUN 1997	1.70 / 5'7"	
TUN - Tunisia	HAFSI Wafa	29 FEB 1996	1.56 / 5'1"	
TUR - Turkey	CAGIRIR Ayse	1 DEC 1995		

Total athletes: 7



## Competition Sheet

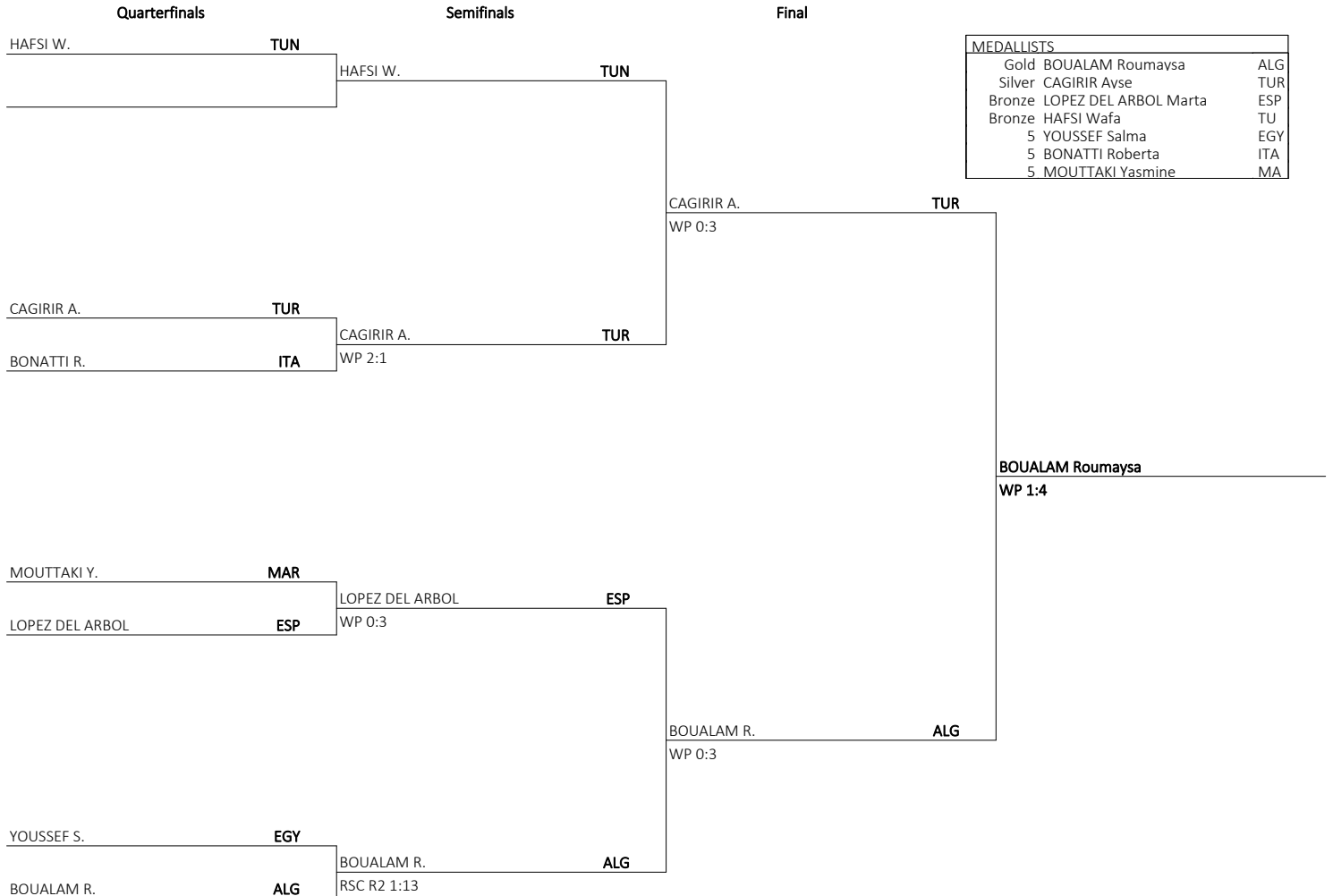



Salle EMEC Palais expositions

Boxing

Women's 48kg



## Final Standings

Rank	Name	Country Cod
Gold	BOUALAM Roumaysa	ALG
Silver	CAGIRIR Ayse	TUR
Bronze	LOPEZ DEL ARBOL Marta	ESP
Bronze	HAFSI Wafa	TUN
5	YOUSSEF Salma	EGY
5	BONATTI Roberta	ITA
5	MOUZZAKI Yasmine	MAR





## Entry List by Event

Ctry	Name	Date of Birth	Height m / ft	World Rank
ALG - Algeria	MANSOURI Fatiha	23 MAY 1997	1.73 / 5' 8"	
EGY - Egypt	MOHAMED Eman	10 JUN 1996	1.56 / 5' 1"	
ESP - Spain	FUERTES FERNANDEZ Laura	29 APR 1999	1.63 / 5' 4"	
FRA - France	MOULAI Romane	29 JUL 1999	1.59 / 5' 3"	
ITA - Italy	SORRENTINO Giordana	27 APR 2000		
TUR - Turkey	CAKIROGLU Buse Naz	26 MAY 1996		

Total athletes: 6



## Competition Sheet

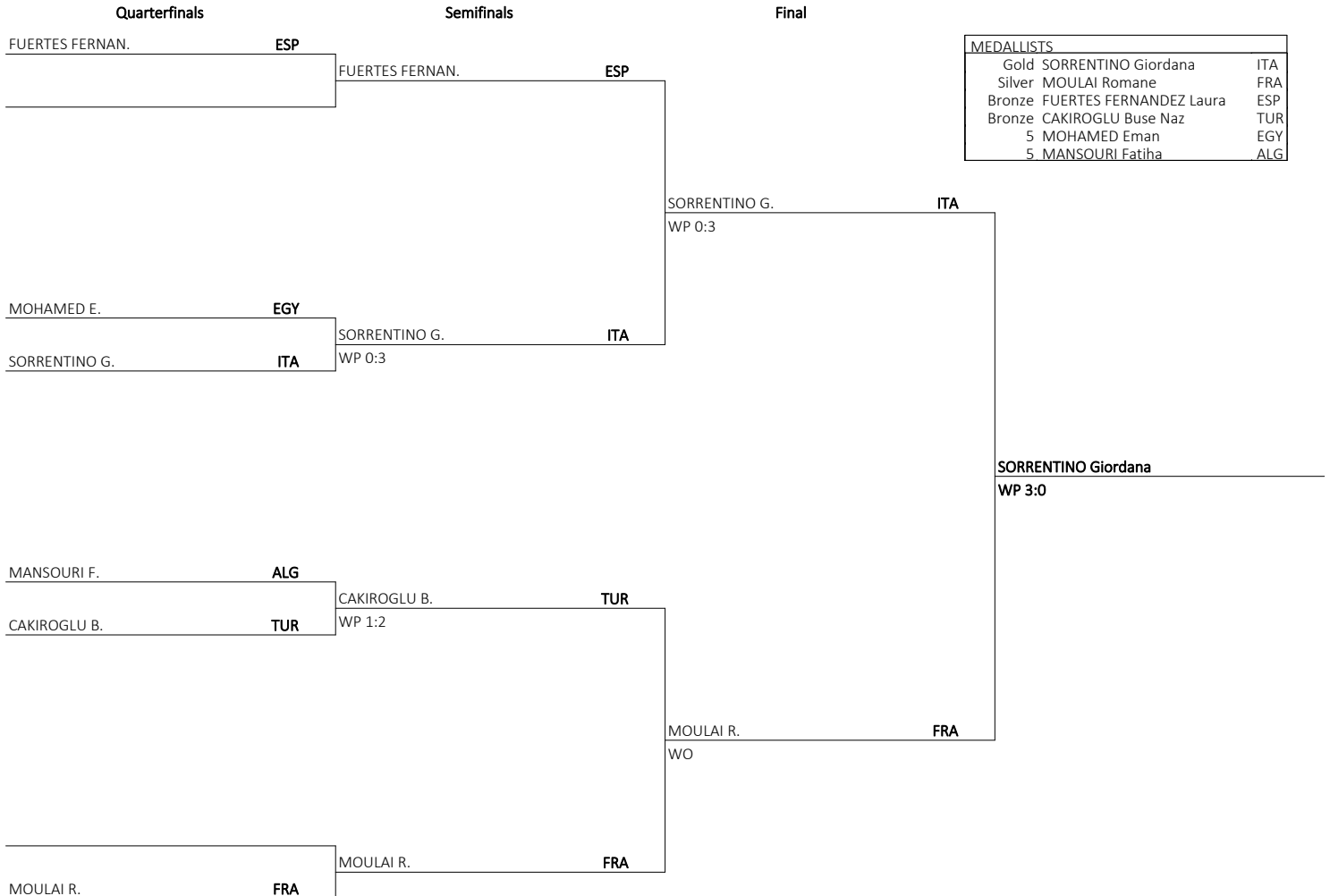



Salle EMEC Palais expositions

Boxing  
Women's 50kg



## Final Standings

Rank	Name	Country Cod
Gold	SORRENTINO Giordana	ITA
Silver	MOULAI Romane	FRA
Bronze	FUERTES FERNANDEZ Laura	ESP
Bronze	CAKIROGLU Buse Naz	TUR
5	MOHAMED Eman	EGY
5	MANSOURI Fatiha	ALG



## Entry List by Event

Ctry	Name	Date of Birth	Height m / ft	World Rank
ALG - Algeria	ABDELKADER HEDJALA Fatma Zohra	24 JUN 1992		
CRO - Croatia	CACIC Nikolina	4 JAN 2001	1.70 / 5' 7"	
EGY - Egypt	AYYAD Yomna	29 JUN 2003	1.69 / 5' 7"	
ESP - Spain	MADUENO CONDE Maria Del Carmen	27 OCT 1997	1.68 / 5' 6"	
FRA - France	FRIGA Salma	2 OCT 2001	1.62 / 5' 4"	
ITA - Italy	CHARAABI Sirine	7 MAY 1999		
LBN - Lebanon	KHATOUN Zeinab	27 AUG 1983		
MAR - Morocco	BERTAL Widad	31 AUG 1999	1.70 / 5' 7"	
MNE - Montenegro	GOJKOVIC Bojana	2 AUG 2003	1.57 / 5' 2"	
TUN - Tunisia	CHEBBI Amel	1 OCT 1996	1.65 / 5' 5"	
TUR - Turkey	AKBAS Hatice	24 JUN 2001		

Total athletes: 11



## Competition Sheet

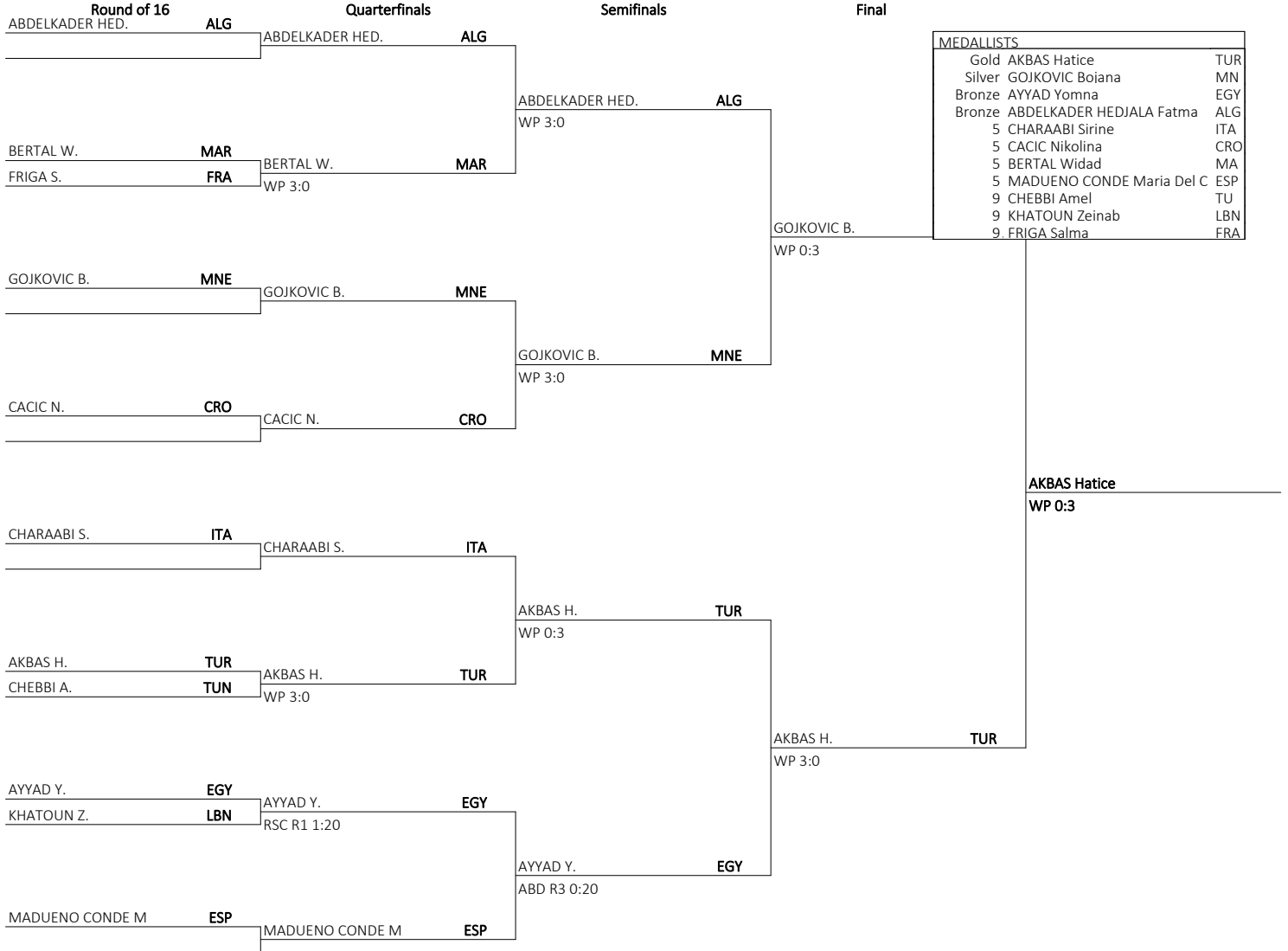



## Final Standings

Rank	Name	Country Cod
Gold	AKBAS Hatice	TUR
Silver	GOJKOVIC Bojana	MNE
Bronze	AYYAD Yomna	EGY
Bronze	ABDELKADER HEDJALA Fatma Zohra	ALG
5	CHARAABI Sirine	ITA
5	CACIC Nikolina	CRO
5	BERTAL Widad	MAR
5	MADUENO CONDE Maria Del Carmen	ESP
9	CHEBBI Amel	TUN
9	KHATOUN Zeinab	LBN
9	FRIGA Salma	FRA



## Entry List by Event

Ctry	Name	Date of Birth	Height m / ft	World Rank
ALG - Algeria	KHELIF Hadjila	1 SEP 1997	1.70 / 5'7"	
EGY - Egypt	HUSSEIN Mariam	1 OCT 2003	1.75 / 5'9"	
FRA - France	ZIDANI Amina	23 AUG 1993		
GRE - Greece	PAPADATOU Olga Pavlina	3 FEB 1992	1.63 / 5'4"	
ITA - Italy	NICOLI Rebecca	29 SEP 1999		
MAR - Morocco	RHADDI Chaymae	12 OCT 1997	1.58 / 5'2"	
TUN - Tunisia	HOMRANI EP ZAYANI Mariem	25 JAN 1991	1.66 / 5'5"	

Total athletes: 7



## Competition Sheet

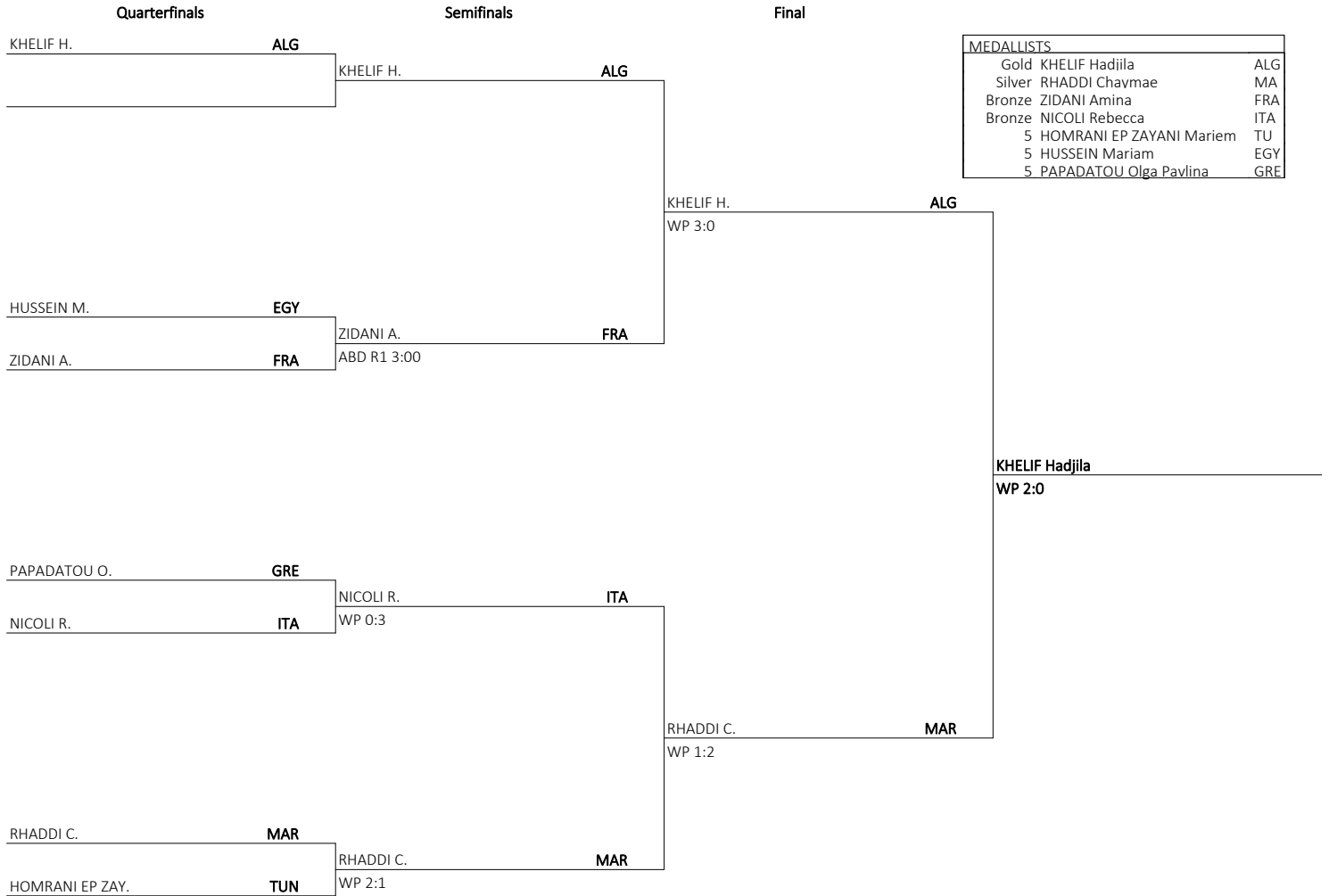





## Final Standings

Rank	Name	Country Cod
Gold	KHELIF Hadjila	ALG
Silver	RHADDI Chaymae	MAR
Bronze	ZIDANI Amina	FRA
Bronze	NICOLI Rebecca	ITA
5	HOMRANI EP ZAYANI Mariem	TUN
5	HUSSEIN Mariam	EGY
5	PAPADATOU Olga Pavlina	GRE



## Entry List by Event

Ctry	Name	Date of Birth	Height m / ft	World Rank
ALG - Algeria	KHELIF Imane	2 MAY 1999	1.78 / 5' 10"	
BIH - Bosnia and Herzegovina	BOHATJUK Tara	28 AUG 2003	1.74 / 5' 9"	
EGY - Egypt	MOHAMED Rahma	18 MAR 2002	1.69 / 5' 7"	
FRA - France	LARCHE Thaïs, Alice	26 MAY 2001	1.72 / 5' 8"	
ITA - Italy	CANFORA Assunta	11 JUL 1992		
TUR - Turkey	OZER Gizem	9 APR 2001		

Total athletes: 6



## Competition Sheet

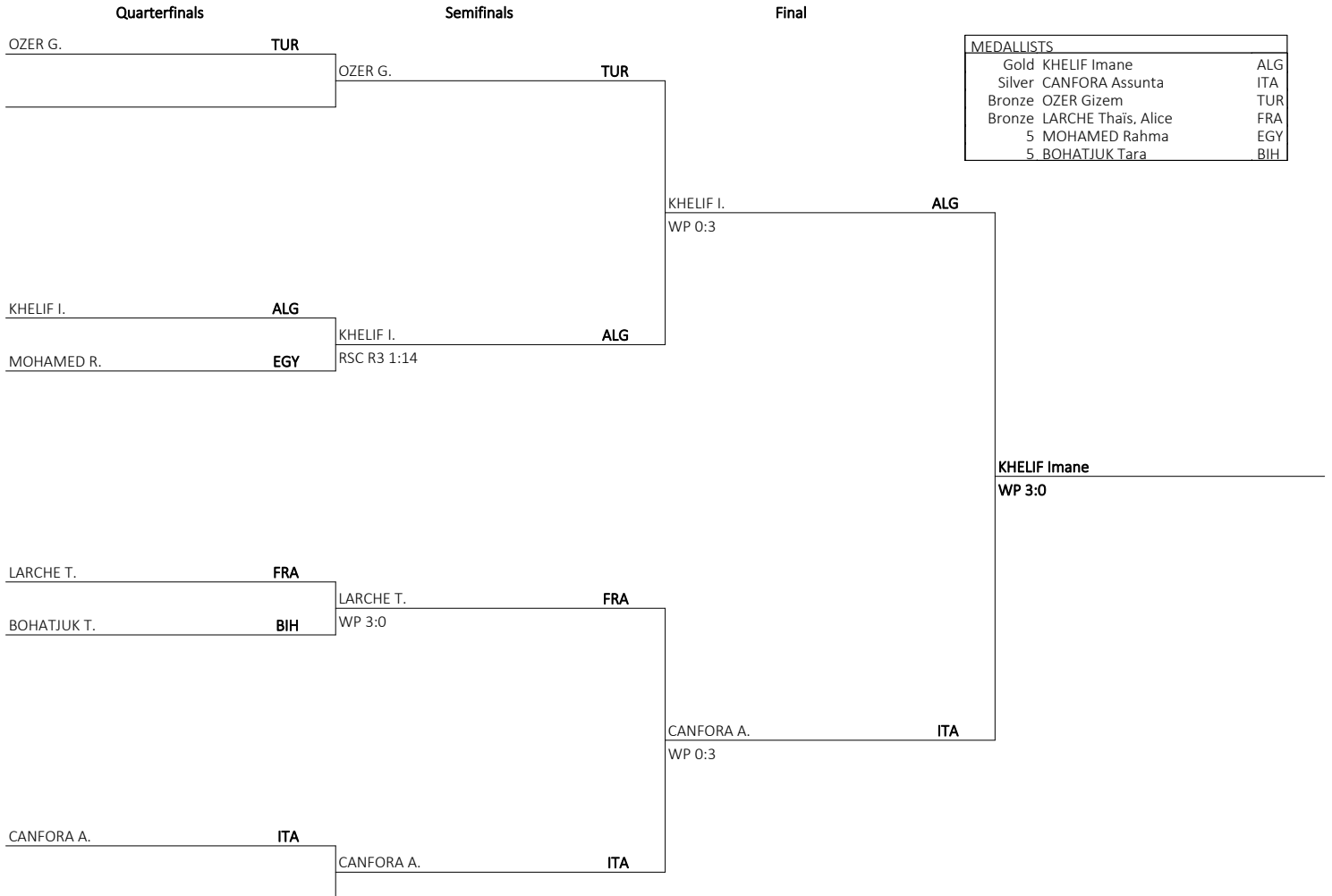



## Final Standings

Rank	Name	Country Cod
Gold	KHELIF Imane	ALG
Silver	CANFORA Assunta	ITA
Bronze	OZER Gizem	TUR
Bronze	LARCHE Thais, Alice	FRA
5	MOHAMED Rahma	EGY
5	BOHATJUK Tara	BIH



## Entry List by Event

Ctry	Name	Date of Birth	Height m / ft	World Rank
ALG - Algeria	CHAIB Ichrak	16 JAN 2001	1.75 / 5'9"	
EGY - Egypt	KHALED Arwa	26 DEC 1996	1.73 / 5'8"	
FRA - France	BENMESSAHEL Fatia, Lamia	21 AUG 1999	1.76 / 5'9"	
ITA - Italy	GEMINI Melissa	8 JUN 2002		
MAR - Morocco	BEL AHBIB Oumayma	21 AUG 1996	1.70 / 5'7"	
SRB - Serbia	GAJIC Nikolina	10 JUL 2000	1.68 / 5'6"	
TUR - Turkey	SURMENELI Busenaz	26 MAY 1998		

Total athletes: 7



## Competition Sheet

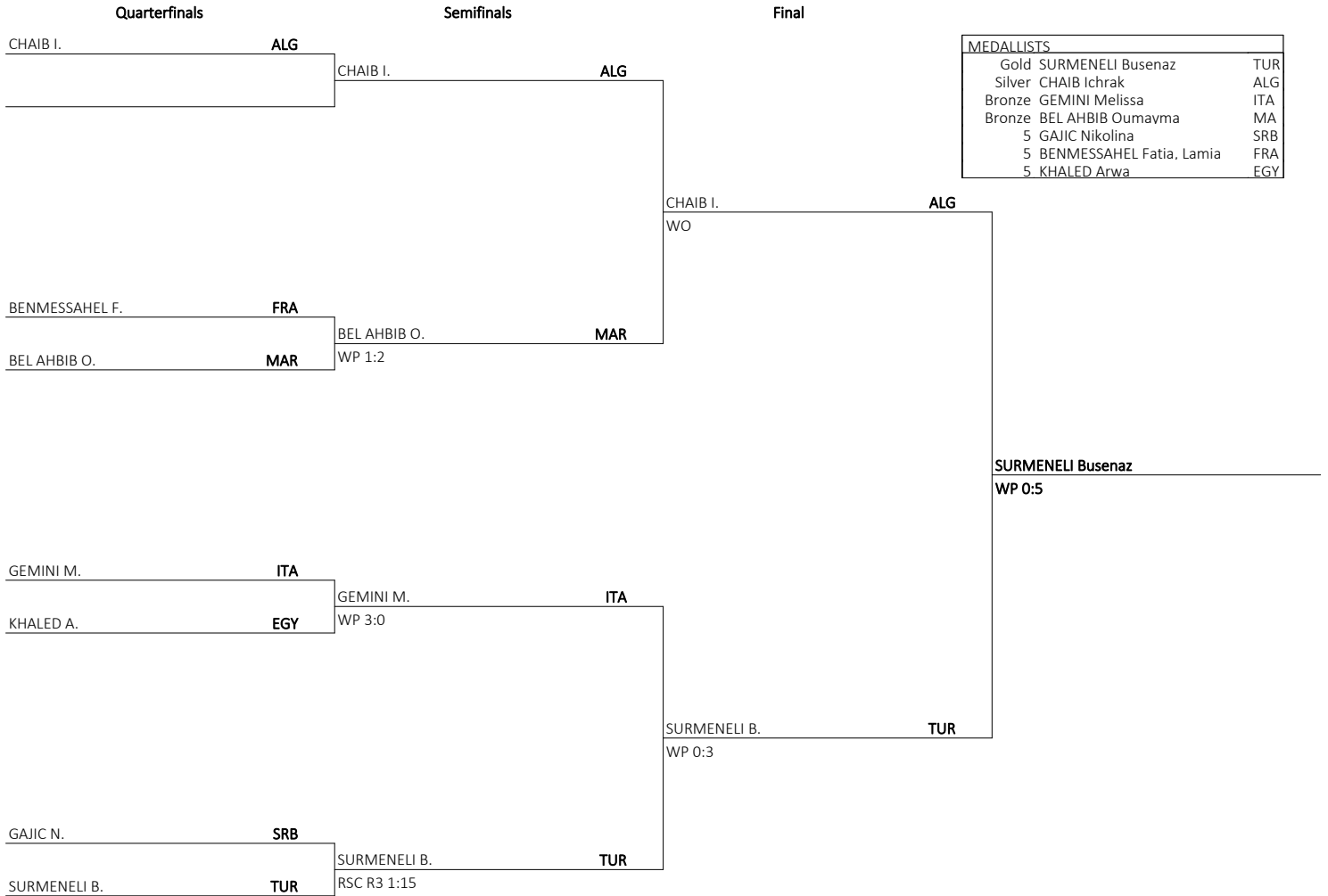

MEDALLISTS		
Gold	SURMENELI Busenaz	TUR
Silver	CHAIB Ichrak	ALG
Bronze	GEMINI Melissa	ITA
Bronze	BEL AHBIB Oumayma	MA
5	GAJIC Nikolina	SRB
5	BENMESSAHEL Fatia, Lamia	FRA
5	KHALED Arwa	EGY



## Final Standings

Rank	Name	Country Cod
Gold	SURMENELI Busenaz	TUR
Silver	CHAIB Ichrak	ALG
Bronze	GEMINI Melissa	ITA
Bronze	BEL AHBIB Oumayma	MAR
5	GAJIC Nikolina	SRB
5	BENMESSAHEL Fatia, Lamia	FRA
5	KHALED Arwa	EGY



ألعاب البحر الأبيض المتوسط  
MEDITERRANEAN GAMES  
JEUX MÉDITERRANÉENS  
du 25 juin au 06 juillet

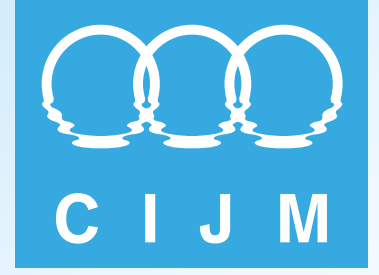

# Results Book



## Cycling Road



**TOSYALI  
ALGERIE**

Fer et Acier

سوناطراي



sonarach



microplus  
DATA PROCESSING & TIMING  
[www.microplustiming.com](http://www.microplustiming.com)





## Medallists by Event

As of SAT 2 JUL 2022 at 20:16

After 4 of 4 events

Event Name	Date	Medal	Name	CTRY Code
Women Road Race	SAT 2 JUL 2022	GOLD	GUARISCHI Barbara	ITA
		SILVER	VOETS DE SOUSA Daniela Maria	POR
		BRONZE	ALONSO DOMINGUEZ Sandra	ESP
Women Time Trial	THU 30 JUN 2022	GOLD	GUAZZINI Vittoria	ITA
		SILVER	BUJAK Eugenia	SLO
		BRONZE	KERBAOL Cedrine	FRA
Men Road Race	SAT 2 JUL 2022	GOLD	PENHOET Paul	FRA
		SILVER	COSTIOU Ewen	FRA
		BRONZE	RETAILLEAU Valentin	FRA
Men Time Trial	THU 30 JUN 2022	GOLD	FERREIRA REIS Rafael	POR
		SILVER	PALENI Enzo	FRA
		BRONZE	ILIC Ognjen	SRB



## Entry List by Event

CTRY	Bib	UCI Code	Name	Date of Birth	Height m / ft in	Weight kg / lbs
ALG - Algeria	1	10006392381	LAGAB Azzedine	18 SEP 1986	1.75 / 5' 9"	63 / 139
	2	10006497970	REGUIGUI Youcef	9 JAN 1990	1.78 / 5' 10"	70 / 154
	4	10008714018	SAIDI Nassim	9 DEC 1994	1.75 / 5' 9"	66 / 146
	3	10010994528	HAMZA Yacine	18 APR 1997	1.75 / 5' 9"	63 / 139
	6	10015589294	MANSOURI Hamza	13 APR 1999	1.75 / 5' 9"	60 / 132
	5	10009635417	MANSOURI Islam	23 JUL 1997	1.75 / 5' 9"	60 / 132
	7	10064460120	N'HARI Mohamed Amine	6 OCT 2000	1.75 / 5' 9"	60 / 132
	8	10092166350	AMARI Hamza	2 OCT 2002	1.75 / 5' 9"	60 / 132
BIH - Bosnia and Herzegovina	67	10006033279	KARIC Vedad	6 MAR 1988	1.82 / 6' 0"	76 / 168
CYP - Cyprus	92	10010664324	MILTADIS Andreas	30 AUG 1996	1.80 / 5' 11"	72 / 159
	91	10015094089	AGROTIS Alexandros	13 JUL 1998	1.70 / 5' 7"	75 / 165
ESP - Spain	11	1004145612	ALVAREZ RODRIGUEZ Rodrigo	24 AUG 1999	1.75 / 5' 9"	67 / 148
	12	10042256618	AZPARREN IRURZUN Enekoitz	5 AUG 2002	1.81 / 5' 11"	63 / 139
	18	10039864556	BENNASSAR ROSSELLO Francesc	8 JUL 2002	1.92 / 6' 4"	69 / 152
	13	10023556331	BERASATEGI GARMENDIA Xabier	8 APR 2000	1.73 / 5' 8"	65 / 143
	14	10102045394	CAMPUBI PIJUAN Marcel	15 SEP 2001	1.79 / 5' 10"	69 / 152
	15	10041189719	GARCIA FRANCES Pablo	16 JAN 2001	1.83 / 6' 0"	67 / 148
	16	10043703332	RETEGUI GONI Mikel	27 APR 2001	1.77 / 5' 10"	65 / 143
FRA - France	17	10041896910	TERCERO LOPEZ Fernando	28 DEC 2001	1.81 / 5' 11"	63 / 139
	21	10027246876	BARRE Louis	6 APR 2000	1.83 / 6' 0"	
	22	10069594854	BAUDIN Alex	25 MAY 2001	1.83 / 6' 0"	66 / 146
	23	10070995694	COSTIOU Ewen	10 NOV 2002	1.76 / 5' 9"	64 / 141
	24	10069510079	LE BERRE Mathis	16 APR 2001	1.76 / 5' 9"	66 / 146
	26	10073945003	PALENI Enzo	30 MAY 2002	1.78 / 5' 10"	66 / 146
	27	10068413878	PENHOET Paul	28 DEC 2001	1.73 / 5' 8"	65 / 143
	28	10023523288	RETAILLEAU Valentin	18 JUN 2000	1.83 / 6' 0"	65 / 143
25	10069444607	MARAIS Benjamin	11 SEP 2002	1.78 / 5' 10"	64 / 141	
GRE - Greece	95	10005495739	TZORTZAKIS Polychronis	3 JAN 1989	1.86 / 6' 1"	78 / 172
ITA - Italy	38	10014829058	ZURLO Matteo	1 AUG 1998		
	33	10010713430	GIORDANI Carloalberto	24 OCT 1997		
	35	10030049671	PERSICO Davide	1 APR 2001	1.83 / 6' 0"	70 / 154
	31	10015920007	BELLERI Michael	13 MAY 1999		
	37	10015135519	ZAMBELLI Samuele	2 APR 1998	1.80 / 5' 11"	79 / 174
	32	10016297596	COATI Luca	30 NOV 1999		
LBA - Libya	36	10029209512	PINAZZI Mattia	4 APR 2001		
	94	10090537154	LAYTEEM Ans	14 JUL 2000	1.74 / 5' 9"	60 / 132
MAR - Morocco	93	10080684984	BADI Labib Tark	18 MAY 1994	1.74 / 5' 9"	72 / 159
	42	10055923817	ED-DOGHMY Achraf	19 NOV 1999	1.80 / 5' 11"	70 / 154



## Entry List by Event

CTRY	Bib	UCI Code	Name	Date of Birth	Height m / ft in	Weight kg / lbs
	46	10049713591	MAATOUGUI Nasr-eddine	21 MAR 2002	1.80 / 5' 11"	70 / 154
	48	10014500773	SABBAHI El Houcaine	8 OCT 1997	1.80 / 5' 11"	70 / 154
	47	10010645429	MAKHCHOUN Mounir	7 SEP 1994	1.80 / 5' 11"	70 / 154
	45	10016178267	HASNI Zakariae	22 NOV 1997	1.80 / 5' 11"	70 / 154
	44	10049512824	EL AZHARI Mounir	22 JAN 1999	1.80 / 5' 11"	70 / 154
	41	10008659959	AIT EL ABDIA Anass	21 MAR 1993	1.70 / 5' 7"	66 / 146
	43	10016178065	EL ARBAOUI Adil	15 FEB 1995	1.80 / 5' 11"	75 / 165
<b>MLT - Malta</b>	96	10114894056	BONELLO Daniel Joseph	11 NOV 1986	1.85 / 6' 1"	65 / 143
<b>MON - Monaco</b>	97	10078179960	BERLIN Antoine	2 AUG 1989	1.70 / 5' 7"	57 / 126
<b>POR - Portugal</b>	73	10044107395	FERNANDES DA COSTA Fábio Manuel	4 JUL 1999	1.74 / 5' 9"	60 / 132
	75	10045289179	LOPES FERNANDES Fábio André	18 JUL 2002	1.70 / 5' 7"	60 / 132
	72	10008674410	DA SILVA GOMES Luis Gabriel	7 MAY 1994	1.78 / 5' 10"	60 / 132
	71	10010714238	BRITO CAMPOS Francisco Joaquim	10 OCT 1997	1.70 / 5' 7"	55 / 121
	74	10006878900	FERREIRA REIS Rafael	15 JUL 1992	1.90 / 6' 3"	70 / 154
<b>SLO - Slovenia</b>	87	10015327293	JARC Aljaz	9 APR 1999	1.90 / 6' 3"	75 / 165
	88	10017629530	MURN Bostjan	15 JAN 2001	1.88 / 6' 2"	78 / 172
	89	10008689766	PER David	13 FEB 1995	1.91 / 6' 3"	79 / 174
	86	10010969468	FINKST Tilen	6 JUL 1997	1.76 / 5' 9"	70 / 154
<b>SRB - Serbia</b>	79	10015338512	STOJNIC Veljko	4 FEB 1999		
	78	10009436262	RAJOVIC Dusan	19 NOV 1997		
	76	10015213725	ILIC Ognjen	21 NOV 1998		
	77	10049809076	DURIC Dorde	21 JUN 2000		
<b>TUN - Tunisia</b>	53	10006518986	HASNAOUI Maher	22 SEP 1989	1.91 / 6' 3"	80 / 176
	57	10108107187	NOUISRI Ali	20 JAN 1994	1.85 / 6' 1"	76 / 168
	54	10061534760	KAMMOUN Khaled	31 OCT 1998	1.86 / 6' 1"	75 / 165
	58	10015182201	TLIBA Achraf	11 JUL 1998	1.76 / 5' 9"	64 / 141
	56	10099087201	MECHERGUI Mohamed Amine	6 AUG 2003	1.82 / 6' 0"	64 / 141
	52	10054904004	HABOURIA Maher	13 SEP 1998	1.82 / 6' 0"	75 / 165
	55	10084578728	KBAIER Oussama	2 AUG 2002	1.84 / 6' 0"	80 / 176
	51	10010101421	BEN AMAR Nadhem	4 MAY 1993	1.74 / 5' 9"	64 / 141
<b>TUR - Turkey</b>	64	10007508790	ORKEN Ahmet	12 MAR 1993		
	65	10060263252	OZGUR Batuhan	1 FEB 1998		
	63	10063808095	BULUT Samet	18 AUG 2002		
	61	10014955057	ABAY Burak	1 JAN 1996		
	66	10008683100	SAMLI Feritcan	29 JAN 1994		

Total number of athletes: 73



Men - Race Road  
Cycling Road  
Men's Road Race



## Entry List by Event

CTRY	Bib	UCI Code	Name	Date of Birth	Height m / ft in	Weight kg / lbs
------	-----	----------	------	---------------	---------------------	--------------------



SAT 2 JUL 2022

## Start List

Start Time 10:00

Bib	UCI Code	Name	CTRY	Date of Birth
1	100063923	LAGAB Azzedine	ALG	18 SEP 1986
2	100064979	REGUIGUI Youcef	ALG	9 JAN 1990
3	100109945	HAMZA Yacine	ALG	18 APR 1997
4	100087140	SAIDI Nassim	ALG	9 DEC 1994
5	100096354	MANSOURI Islam	ALG	23 JUL 1997
6	100155892	MANSOURI Hamza	ALG	13 APR 1999
7	100644601	N'HARI Mohamed Amine	ALG	6 OCT 2000
8	100921663	AMARI Hamza	ALG	2 OCT 2002
11	100414561	ALVAREZ RODRIGUEZ Rodrigo	ESP	24 AUG 1999
12	100422566	AZPARREN IRURZUN Enekoitz	ESP	5 AUG 2002
13	100235563	BERASATEGI GARMENDIA Xabier	ESP	8 APR 2000
14	101020453	CAMPRUBI PIJUAN Marcel	ESP	15 SEP 2001
15	100411897	GARCIA FRANCES Pablo	ESP	16 JAN 2001
16	100437033	RETEGUI GONI Mikel	ESP	27 APR 2001
17	100418969	TERCERO LOPEZ Fernando	ESP	28 DEC 2001
18	100398645	BENNASSAR ROSSELLO Francesc	ESP	8 JUL 2002
21	100272468	BARRE Louis	FRA	6 APR 2000
22	100695948	BAUDIN Alex	FRA	25 MAY 2001
23	100709956	COSTIOU Ewen	FRA	10 NOV 2002
24	100695100	LE BERRE Mathis	FRA	16 APR 2001
25	100694446	MARAIS Benjamin	FRA	11 SEP 2002
26	100739450	PALENI Enzo	FRA	30 MAY 2002
27	100684138	PENHOET Paul	FRA	28 DEC 2001
28	100235232	RETAILLEAU Valentin	FRA	18 JUN 2000
31	100159200	BELLERI Michael	ITA	13 MAY 1999
32	100162975	COATI Luca	ITA	30 NOV 1999
33	100107134	GIORDANI Carloalberto	ITA	24 OCT 1997
35	100300496	PERSICO Davide	ITA	1 APR 2001
36	100292095	PINAZZI Mattia	ITA	4 APR 2001
37	100151355	ZAMBELLI Samuele	ITA	2 APR 1998
38	100148290	ZURLO Matteo	ITA	1 AUG 1998
41	100086599	AIT EL ABDIA Anass	MAR	21 MAR 1993
42	100559238	ED-DOGHMY Achraf	MAR	19 NOV 1999
43	100161780	EL ARBAOUI Adil	MAR	15 FEB 1995
44	100495128	EL AZHARI Mounir	MAR	22 JAN 1999
45	100161782	HASNI Zakariae	MAR	22 NOV 1997
46	100497135	MAATOUGUI Nasr-eddine	MAR	21 MAR 2002
47	100106454	MAKHCHOUN Mounir	MAR	7 SEP 1994
48	100145007	SABBAHI El Houcaine	MAR	8 OCT 1997
51	100101014	BEN AMAR Nadhem	TUN	4 MAY 1993
52	100549040	HABOURIA Maher	TUN	13 SEP 1998
53	100065189	HASNAOUI Maher	TUN	22 SEP 1989
54	100615347	KAMMOUN Khaled	TUN	31 OCT 1998
55	100845787	KBAIER Oussama	TUN	2 AUG 2002
56	100990872	MECHERGUI Mohamed Amine	TUN	6 AUG 2003



SAT 2 JUL 2022

## Start List

Start Time 10:00

Bib	UCI Code	Name	CTRY	Date of Birth
57	101081071	NOUISRI Ali	TUN	20 JAN 1994
58	100151822	TLIBA Achraf	TUN	11 JUL 1998
61	100149550	ABAY Burak	TUR	1 JAN 1996
63	100638080	BULUT Samet	TUR	18 AUG 2002
64	100075087	ORKEN Ahmet	TUR	12 MAR 1993
65	100602632	OZGUR Batuhan	TUR	1 FEB 1998
66	100086831	SAMLI Feritcan	TUR	29 JAN 1994
67	100060332	KARIC Vedad	BIH	6 MAR 1988
71	100107142	BRITO CAMPOS Francisco Joaquim	POR	10 OCT 1997
72	100086744	DA SILVA GOMES Luis Gabriel	POR	7 MAY 1994
73	100441073	FERNANDES DA COSTA Fábio Manuel	POR	4 JUL 1999
74	100068789	FERREIRA REIS Rafael	POR	15 JUL 1992
75	100452891	LOPES FERNANDES Fábio André	POR	18 JUL 2002
76	100152137	ILIC Ognjen	SRB	21 NOV 1998
77	100498090	DURIC Dorde	SRB	21 JUN 2000
78	100094362	RAJOVIC Dusan	SRB	19 NOV 1997
79	100153385	STOJNIC Veljko	SRB	4 FEB 1999
86	100109694	FINKST Tilen	SLO	6 JUL 1997
87	100153272	JARC Aljaz	SLO	9 APR 1999
88	100176295	MURN Bostjan	SLO	15 JAN 2001
89	100086897	PER David	SLO	13 FEB 1995
91	100150940	AGROTIS Alexandros	CYP	13 JUL 1998
92	100106643	MILTADIS Andreas	CYP	30 AUG 1996
93	100806849	BADI Labib Tark	LBA	18 MAY 1994
94	100905371	LAYTEEM Ans	LBA	14 JUL 2000
95	100054957	TZORTZAKIS Polychronis	GRE	3 JAN 1989
96	101148940	BONELLO Daniel Joseph	MLT	11 NOV 1986
97	100781799	BERLIN Antoine	MON	2 AUG 1989

Entries/CTRYs	Total Race Distance
73/16	145Km



Men - Race Road  
Cycling Road  
Men's Road Race  
Final



SAT 2 JUL 2022

Final Results

Start Time 10:30

Race distance: 145,00 km

Rank	Bib	UCI Code	Name	CTRY	Final Time	Time Behind	Average Speed
1	27	10068413878	PENHOET Paul	FRA	3:12:23		45.222
2	23	10070995694	COSTIOU Ewen	FRA	3:12:23		45.222
3	28	10023523288	RETAILLEAU Valentin	FRA	3:12:28	+5	45.203
4	86	10010969468	FINKST Tilen	SLO	3:12:28	+5	45.203
5	24	10069510079	LE BERRE Mathis	FRA	3:12:28	+5	45.203
6	77	10049809076	DURIC Dorde	SRB	3:12:28	+5	45.203
7	22	10069594854	BAUDIN Alex	FRA	3:12:28	+5	45.203
8	41	10008659959	AIT EL ABDIA Anass	MAR	3:12:28	+5	45.203
9	43	10016178065	EL ARBAOUI Adil	MAR	3:12:35	+12	45.175
10	2	10006497970	REGUIGUI Youcef	ALG	3:13:45	+1:22	44.903
11	37	10015135519	ZAMBELLI Samuele	ITA	3:13:45	+1:22	44.903
12	95	10005495739	TZORTZAKIS Polychronis	GRE	3:13:45	+1:22	44.903
13	89	10008689766	PER David	SLO	3:13:48	+1:25	44.892
14	26	10073945003	PALENI Enzo	FRA	3:13:50	+1:27	44.884
15	79	10015338512	STOJNIC Veljko	SRB	3:14:02	+1:39	44.838
16	21	10027246876	BARRE Louis	FRA	3:14:02	+1:39	44.838
17	11	1004145612	ALVAREZ RODRIGUEZ Rodrigo	ESP	3:15:34	+3:11	44.486
18	18	10039864556	BENNASSAR ROSSELLO Francesc	ESP	3:15:34	+3:11	44.486
19	72	10008674410	DA SILVA GOMES Luis Gabriel	POR	3:15:34	+3:11	44.486
20	8	10092166350	AMARI Hamza	ALG	3:15:34	+3:11	44.486
21	38	10014829058	ZURLO Matteo	ITA	3:15:34	+3:11	44.486
22	47	10010645429	MAKHCHOUN Mounir	MAR	3:15:34	+3:11	44.486



Men - Race Road  
Cycling Road  
Men's Road Race  
Final



SAT 2 JUL 2022

Final Results

Start Time 10:30

Race distance: 145,00 km

Rank	Bib	UCI Code	Name	CTRY	Final Time	Time Behind	Average Speed
23	4	10008714018	SAIDI Nassim	ALG	3:15:34	+3:11	44.486
24	78	10009436262	RAJOVIC Dusan	SRB	3:15:34	+3:11	44.486
25	52	10054904004	HABOURIA Maher	TUN	3:15:34	+3:11	44.486
26	3	10010994528	HAMZA Yacine	ALG	3:15:34	+3:11	44.486
27	74	10006878900	FERREIRA REIS Rafael	POR	3:15:35	+3:12	44.482
28	67	10006033279	KARIC Vedad	BIH	3:15:35	+3:12	44.482
29	42	10055923817	ED-DOGHMY Achraf	MAR	3:15:35	+3:12	44.482
30	96	10114894056	BONELLO Daniel Joseph	MLT	3:15:35	+3:12	44.482
31	92	10010664324	MILTADIS Andreas	CYP	3:15:35	+3:12	44.482
32	65	10060263252	OZGUR Batuhan	TUR	3:15:35	+3:12	44.482
33	91	10015094089	AGROTIS Alexandros	CYP	3:15:35	+3:12	44.482
34	5	10009635417	MANSOURI Islam	ALG	3:15:35	+3:12	44.482
35	1	10006392381	LAGAB Azzedine	ALG	3:15:35	+3:12	44.482
36	61	10014955057	ABAY Burak	TUR	3:15:35	+3:12	44.482
37	13	10023556331	BERASATEGI GARMENDIA Xabier	ESP	3:15:35	+3:12	44.482
38	88	10017629530	MURN Bostjan	SLO	3:15:35	+3:12	44.482
39	12	10042256618	AZPARREN IRURZUN Enekoitz	ESP	3:15:35	+3:12	44.482
40	32	10016297596	COATI Luca	ITA	3:15:35	+3:12	44.482
41	35	10030049671	PERSICO Davide	ITA	3:15:35	+3:12	44.482
42	33	10010713430	GIORDANI Carloalberto	ITA	3:15:41	+3:18	44.460
43	36	10029209512	PINAZZI Mattia	ITA	3:15:41	+3:18	44.460
44	87	10015327293	JARC Aljaz	SLO	3:15:41	+3:18	44.460





Men - Race Road  
Cycling Road  
Men's Road Race  
Final



SAT 2 JUL 2022

## Final Results

Start Time 10:30

Race distance: 145,00 km

Rank	Bib	UCI Code	Name	CTRY	Final Time	Time Behind	Average Speed
45	25	10069444607	MARAIS Benjamin	FRA	3:15:44	+3:21	44.448
46	73	10044107395	FERNANDES DA COSTA Fábio Manuel	POR	3:16:01	+3:38	44.384
47	64	10007508790	ORKEN Ahmet	TUR	3:30:02	+17:39	41.422
48	97	10078179960	BERLIN Antoine	MON	3:30:54	+18:31	41.252
49	75	10045289179	LOPES FERNANDES Fábio André	POR	3:30:54	+18:31	41.252
50	44	10049512824	EL AZHARI Mounir	MAR	3:30:54	+18:31	41.252
51	71	10010714238	BRITO CAMPOS Francisco Joaquim	POR	3:30:54	+18:31	41.252
52	57	10108107187	NOUISRI Ali	TUN	3:30:54	+18:31	41.252
53	54	10061534760	KAMMOUN Khaled	TUN	3:30:54	+18:31	41.252
54	48	10014500773	SABBAHI El Houcaine	MAR	3:30:54	+18:31	41.252
55	55	10084578728	KBAIER Oussama	TUN	3:30:54	+18:31	41.252
56	46	10049713591	MAATOUGUI Nasr-eddine	MAR	3:30:54	+18:31	41.252
57	63	10063808095	BULUT Samet	TUR	3:33:05	+20:42	40.829
58	66	10008683100	SAMLI Feritcan	TUR	3:33:05	+20:42	40.829
59	58	10015182201	TLIBA Achraf	TUN	3:33:05	+20:42	40.829
60	45	10016178267	HASNI Zakariae	MAR	3:35:38	+23:15	40.346
61	14	10102045394	CAMPRUBI PIJUAN Marcel	ESP	3:37:06	+24:43	40.074
	6	10015589294	MANSOURI Hamza	ALG	DNF		
	7	10064460120	N'HARI Mohamed Amine	ALG	DNF		
	15	10041189719	GARCIA FRANCES Pablo	ESP	DNF		
	16	10043703332	RETEGUI GONI Mikel	ESP	DNS		
	17	10041896910	TERCERO LOPEZ Fernando	ESP	DNS		



Men - Race Road  
Cycling Road  
Men's Road Race  
Final



SAT 2 JUL 2022

## Final Results

Start Time 10:30

Race distance: 145,00 km

Rank	Bib	UCI Code	Name	CTRY	Final Time	Time Behind	Average Speed
	31	10015920007	BELLERI Michael	ITA	DNF		
	51	10010101421	BEN AMAR Nadhem	TUN	DNF		
	53	10006518986	HASNAOUI Maher	TUN	DNF		
	56	10099087201	MECHERGUI Mohamed Amine	TUN	DNF		
	76	10015213725	ILIC Ognjen	SRB	DNS		
	93	10080684984	BADI Labib Tark	LBA	DNF		
	94	10090537154	LAYTEEM Ans	LBA	DNF		

Average Speed	Total Race Distance
45,222 km/h	145Km

Number of Entries	73		
Runners	70	Did not Finish	9
Did not Start	3		
Arrived	61		

### LEGEND

<b>Bon</b> Bonus	<b>DNF</b> Did not Finish	<b>DNS</b> Did not start	<b>DSQ</b> Disqualified
<b>OT</b> Over time limit	<b>Pen</b> Penalty		



## Entry List by Event

CTRY	Bib	UCI Code	Name	Date of Birth	Height m / ft in	Weight kg / lbs
ALG - Algeria	108	10099022634	HOUILI Nesrine	27 AUG 2003	1.75 / 5'9"	60 / 132
CYP - Cyprus	118	10007704309	CHRISTOFOROU Antri	2 APR 1992	1.70 / 5'7"	64 / 141
ESP - Spain	101	10011154475	ALONSO DOMINGUEZ Sandra	19 AUG 1998	1.78 / 5'10"	63 / 139
	102	10043139621	BENITO PELLICER Mireia	30 DEC 1996	1.69 / 5'7"	60 / 132
	103	10041826077	CANTERA CARRASCO Ines	30 JUL 2002	1.67 / 5'6"	41 / 90
	104	10008601860	GONZALEZ BLANCO Alicia	27 MAY 1995	1.61 / 5'3"	53 / 117
	105	10016311744	MARTIN MARTIN Sara	22 MAR 1999	1.68 / 5'6"	58 / 128
	106	10008651168	OYARBIDE JIMENEZ Lourdes	8 APR 1994	1.60 / 5'3"	52 / 115
FRA - France	111	10067840265	CURINIER Lea	21 APR 2001	1.71 / 5'7"	54 / 119
	112	10066772861	FOUQUENET Amandine	19 FEB 2001	1.66 / 5'5"	60 / 132
	113	10025981028	GRANGIER India	5 JAN 2000	1.68 / 5'6"	53 / 117
	114	10067688095	KERBAOL Cedrine	15 MAY 2001	1.67 / 5'6"	56 / 123
	115	10023522278	LE NET Marie	25 JAN 2000	1.73 / 5'8"	62 / 137
	116	10023490552	WIEL Jade	2 APR 2000	1.58 / 5'2"	53 / 117
GRE - Greece	128	10007934681	FASOI Varvara	2 FEB 1991	1.63 / 5'4"	58 / 128
ITA - Italy	121	10007278822	CONFALONIERI Maria Giulia	30 MAR 1993		
	122	10008672689	FIDANZA Arianna	6 JAN 1995		
	124	10005886365	GUARISCHI Barbara	2 OCT 1990		
	125	10015339118	GUAZZINI Vittoria	26 DEC 2000		
	123	10031546808	GASPARRINI Eleonora Camilla	25 MAR 2002		
	126	10008635610	SANGUINETI Ilaria	15 APR 1994		
POR - Portugal	143	10044087793	VOETS DE SOUSA Daniela Maria	31 MAR 2002	1.74 / 5'9"	60 / 132
	142	10107584401	DE PAIVA VILACA Vera	17 JAN 1998	1.72 / 5'8"	50 / 110
	141	10044298567	CARVALHO ROXO Beatriz Sofia	30 SEP 2003	1.73 / 5'8"	63 / 139
SLO - Slovenia	133	10006412589	BUJAK Eugenia	25 JUN 1989	1.76 / 5'9"	64 / 141
	131	10112168154	BOBNAR Nika	4 JUN 2003	1.67 / 5'6"	64 / 141
	134	10009154861	KERN Spela	24 FEB 1990	1.72 / 5'8"	52 / 115
	135	10007859206	PINTAR Urska	3 OCT 1985	1.69 / 5'7"	55 / 121
	136	10017612453	SUSNIK Tjasa	3 AUG 2002		
TUR - Turkey	145	10063516388	BEKAR Azize	4 MAR 2001		
	146	10015615667	SEZER Fatma	19 MAY 1999		

Total number of athletes: 31



SAT 2 JUL 2022

## Start List

Start Time 17:00

Bib	UCI Code	Name	CTRY	Date of Birth
101	100111544	ALONSO DOMINGUEZ Sandra	ESP	19 AUG 1998
102	100431396	BENITO PELLICER Mireia	ESP	30 DEC 1996
103	100418260	CANTERA CARRASCO Ines	ESP	30 JUL 2002
104	100086018	GONZALEZ BLANCO Alicia	ESP	27 MAY 1995
105	100163117	MARTIN MARTIN Sara	ESP	22 MAR 1999
106	100086511	OYARBIDE JIMENEZ Lourdes	ESP	8 APR 1994
108	100990226	HOUILI Nesrine	ALG	27 AUG 2003
111	100678402	CURINIER Lea	FRA	21 APR 2001
112	100667728	FOUQUENET Amandine	FRA	19 FEB 2001
113	100259810	GRANGIER India	FRA	5 JAN 2000
114	100676880	KERBAOL Cedrine	FRA	15 MAY 2001
115	100235222	LE NET Marie	FRA	25 JAN 2000
116	100234905	WIEL Jade	FRA	2 APR 2000
118	100077043	CHRISTOFOROU Antri	CYP	2 APR 1992
121	100072788	CONFALONIERI Maria Giulia	ITA	30 MAR 1993
122	100086726	FIDANZA Arianna	ITA	6 JAN 1995
123	100315468	GASPARRINI Eleonora Camilla	ITA	25 MAR 2002
124	100058863	GUARISCHI Barbara	ITA	2 OCT 1990
125	100153391	GUAZZINI Vittoria	ITA	26 DEC 2000
126	100086356	SANGUINETI Ilaria	ITA	15 APR 1994
128	100079346	FASOI Varvara	GRE	2 FEB 1991
131	101121681	BOBNAR Nika	SLO	4 JUN 2003
133	100064125	BUJAK Eugenia	SLO	25 JUN 1989
134	100091548	KERN Spela	SLO	24 FEB 1990
135	100078592	PINTAR Urska	SLO	3 OCT 1985
136	100176124	SUSNIK Tjasa	SLO	3 AUG 2002
141	100442985	CARVALHO ROXO Beatriz Sofia	POR	30 SEP 2003
142	101075844	DE PAIVA VILACA Vera	POR	17 JAN 1998
143	100440877	VOETS DE SOUSA Daniela Maria	POR	31 MAR 2002
145	100635163	BEKAR Azize	TUR	4 MAR 2001
146	100156156	SEZER Fatma	TUR	19 MAY 1999

Entries/CTRYs	Total Race Distance
31/16	85Km



Women - Race Road  
Cycling Road  
Women's Road Race  
Final



SAT 2 JUL 2022

Final Results

Start Time 17:00

Race distance: 78,00 km

Rank	Bib	UCI Code	Name	CTRY	Final Time	Time Behind	Average Speed
1	124	10005886365	GUARISCHI Barbara	ITA	1:58:24		39.527
2	143	10044087793	VOETS DE SOUSA Daniela Maria	POR	1:58:24		39.527
3	101	10011154475	ALONSO DOMINGUEZ Sandra	ESP	1:58:24		39.527
4	118	10007704309	CHRISTOFOROU Antri	CYP	1:58:24		39.527
5	126	10008635610	SANGUINETI Ilaria	ITA	1:58:24		39.527
6	115	10023522278	LE NET Marie	FRA	1:58:24		39.527
7	116	10023490552	WIEL Jade	FRA	1:58:24		39.527
8	133	10006412589	BUJAK Eugenia	SLO	1:58:24		39.527
9	128	10007934681	FASOI Varvara	GRE	1:58:24		39.527
10	108	10099022634	HOUILI Nesrine	ALG	1:58:24		39.527
11	104	10008601860	GONZALEZ BLANCO Alicia	ESP	1:58:24		39.527
12	131	10112168154	BOBNAR Nika	SLO	1:58:24		39.527
13	142	10107584401	DE PAIVA VILACA Vera	POR	1:58:24		39.527
14	141	10044298567	CARVALHO ROXO Beatriz Sofia	POR	1:58:24		39.527
15	105	10016311744	MARTIN MARTIN Sara	ESP	1:58:24		39.527
16	111	10067840265	CURINIER Lea	FRA	1:58:24		39.527
17	145	10063516388	BEKAR Azize	TUR	1:58:24		39.527
18	135	10007859206	PINTAR Urska	SLO	1:58:24		39.527
19	125	10015339118	GUAZZINI Vittoria	ITA	1:58:29	+5	39.499
20	114	10067688095	KERBAOL Cedrine	FRA	1:58:29	+5	39.499
21	112	10066772861	FOUQUENET Amandine	FRA	1:58:31	+7	39.488
22	113	10025981028	GRANGIER India	FRA	1:58:31	+7	39.488



Women - Race Road  
Cycling Road  
Women's Road Race  
Final



SAT 2 JUL 2022

Final Results

Start Time 17:00

Race distance: 78,00 km

Rank	Bib	UCI Code	Name	CTRY	Final Time	Time Behind	Average Speed
23	102	10043139621	BENITO PELLICER Mireia	ESP	1:58:33	+9	39.477
24	123	10031546808	GASPARRINI Eleonora Camilla	ITA	1:58:36	+12	39.460
25	121	10007278822	CONFALONIERI Maria Giulia	ITA	1:58:36	+12	39.460
26	106	10008651168	OYARBIDE JIMENEZ Lourdes	ESP	1:58:50	+26	39.383
27	122	10008672689	FIDANZA Arianna	ITA	1:58:50	+26	39.383
28	146	10015615667	SEZER Fatma	TUR	OTL		
29	136	10017612453	SUSNIK Tjasa	SLO	OTL		
	103	10041826077	CANTERA CARRASCO Ines	ESP	DNS		
	134	10009154861	KERN Spela	SLO	DNS		

Average Speed	Total Race Distance
39,527 km/h	78Km

Number of Entries	31	Over Time	2
Runners	29		
Did not Start	2		
Arrived	27		

LEGEND

Bon	Bonus	DNF	Did not Finish	DNS	Did not start	DSQ	Disqualified
OTL	Over time limit	Pen	Penalty				



## Entry List by Event

CTRY	Bib	UCI Code	Name	Date of Birth	Height m / ft in	Weight kg / lbs
ALG - Algeria	6	10015589294	MANSOURI Hamza	13 APR 1999	1.75 / 5' 9"	60 / 132
	7	10064460120	N'HARI Mohamed Amine	6 OCT 2000	1.75 / 5' 9"	60 / 132
CYP - Cyprus	92	10010664324	MILTADIS Andreas	30 AUG 1996	1.80 / 5' 11"	72 / 159
ESP - Spain	12	10042256618	AZPARREN IRURZUN Enekoitz	5 AUG 2002	1.81 / 5' 11"	63 / 139
	14	10102045394	CAMP RUBI PIJUAN Marcel	15 SEP 2001	1.79 / 5' 10"	69 / 152
FRA - France	26	10073945003	PALENI Enzo	30 MAY 2002	1.78 / 5' 10"	66 / 146
	25	10069444607	MARAIS Benjamin	11 SEP 2002	1.78 / 5' 10"	64 / 141
GRE - Greece	95	10005495739	TZORTZAKIS Polychronis	3 JAN 1989	1.86 / 6' 1"	78 / 172
ITA - Italy	32	10016297596	COATI Luca	30 NOV 1999		
LBA - Libya	94	10090537154	LAYTEEM Ans	14 JUL 2000	1.74 / 5' 9"	60 / 132
	93	10080684984	BADI Labib Tark	18 MAY 1994	1.74 / 5' 9"	72 / 159
MAR - Morocco	42	10055923817	ED-DOGHMY Achraf	19 NOV 1999	1.80 / 5' 11"	70 / 154
	43	10016178065	EL ARBAOUI Adil	15 FEB 1995	1.80 / 5' 11"	75 / 165
MLT - Malta	96	10114894056	BONELLO Daniel Joseph	11 NOV 1986	1.85 / 6' 1"	65 / 143
MON - Monaco	97	10078179960	BERLIN Antoine	2 AUG 1989	1.70 / 5' 7"	57 / 126
POR - Portugal	75	10045289179	LOPES FERNANDES Fábio André	18 JUL 2002	1.70 / 5' 7"	60 / 132
	74	10006878900	FERREIRA REIS Rafael	15 JUL 1992	1.90 / 6' 3"	70 / 154
SLO - Slovenia	88	10017629530	MURN Bostjan	15 JAN 2001	1.88 / 6' 2"	78 / 172
SRB - Serbia	76	10015213725	ILIC Ognjen	21 NOV 1998		
TUN - Tunisia	57	10108107187	NOUISRI Ali	20 JAN 1994	1.85 / 6' 1"	76 / 168
	52	10054904004	HABOURIA Maher	13 SEP 1998	1.82 / 6' 0"	75 / 165
TUR - Turkey	64	10007508790	ORKEN Ahmet	12 MAR 1993		

Total number of athletes: 22



THU 30 JUN 2022

## Start List

Start Time 11:00

Group	Start Time	Bib UCI Code	Name	CTRY	Date of Birth	Time
1	11:00	97 10078179960	BERLIN Antoine	MON	2 AUG 1989	
	11:03	64 10007508790	ORKEN Ahmet	TUR	12 MAR 1993	
	11:06	96 10114894056	BONELLO Daniel Joseph	MLT	11 NOV 1986	
	11:09	88 10017629530	MURN Bostjan	SLO	15 JAN 2001	
	11:12	76 10015213725	ILIC Ognjen	SRB	21 NOV 1998	
	11:15	75 10045289179	LOPES FERNANDES Fábio André	POR	18 JUL 2002	
	11:18	25 10069444607	MARAIS Benjamin	FRA	11 SEP 2002	
	11:21	94 10090537154	LAYTEEM Ans	LBA	14 JUL 2000	
	11:24	95 10005495739	TZORTZAKIS Polychronis	GRE	3 JAN 1989	
	11:27	92 10010664324	MILTADIS Andreas	CYP	30 AUG 1996	
	11:30	57 10108107187	NOUISRI Ali	TUN	20 JAN 1994	
	11:33	32 10016297596	COATI Luca	ITA	30 NOV 1999	
	11:36	42 10055923817	ED-DOGHMY Achraf	MAR	19 NOV 1999	
	11:39	7 10064460120	N'HARI Mohamed Amine	ALG	6 OCT 2000	
	11:42	14 10102045394	CAMPRUBI PIJUAN Marcel	ESP	15 SEP 2001	
	11:45	74 10006878900	FERREIRA REIS Rafael	POR	15 JUL 1992	
	11:48	26 10073945003	PALENI Enzo	FRA	30 MAY 2002	
	11:51	93 10080684984	BADI Labib Tark	LBA	18 MAY 1994	
	11:54	52 10054904004	HABOURIA Maher	TUN	13 SEP 1998	
	11:57	43 10016178065	EL ARBAOUI Adil	MAR	15 FEB 1995	
	12:00	6 10015589294	MANSOURI Hamza	ALG	13 APR 1999	
	12:03	12 10042256618	AZPARREN IRURZUN Enekoitz	ESP	5 AUG 2002	
<b>Entries/CTRYs</b>						
22/16						25Km





Men - Time Trial  
Cycling Road  
Men's Time Trial  
Final



THU 30 JUN 2022

Final Results

Start Time 11:00

Race distance: 25,00 km

Rank	Bib	UCI Code	Name	CTRY	Final Time	Time Behind	Average Speed
1	74	10006878900	FERREIRA REIS Rafael	POR	31:28.88		47.647
2	26	10073945003	PALENI Enzo	FRA	32:18.15	+49.27	46.436
3	76	10015213725	ILIC Ognjen	SRB	32:19.63	+50.75	46.401
4	92	10010664324	MILTIADIS Andreas	CYP	32:31.79	+1:02.91	46.112
5	32	10016297596	COATI Luca	ITA	33:06.50	+1:37.62	45.306
6	12	10042256618	AZPARREN IRURZUN Enekoitz	ESP	33:29.24	+2:00.36	44.793
7	25	10069444607	MARAIS Benjamin	FRA	33:39.13	+2:10.25	44.574
8	64	10007508790	ORKEN Ahmet	TUR	33:49.46	+2:20.58	44.347
9	6	10015589294	MANSOURI Hamza	ALG	34:13.90	+2:45.02	43.819
10	95	10005495739	TZORTZAKIS Polychronis	GRE	34:17.65	+2:48.77	43.739
11	75	10045289179	LOPES FERNANDES Fábio André	POR	34:26.43	+2:57.55	43.553
12	7	10064460120	N'HARI Mohamed Amine	ALG	34:55.44	+3:26.56	42.950
13	43	10016178065	EL ARBAOUI Adil	MAR	34:55.90	+3:27.02	42.941
14	42	10055923817	ED-DOGHMY Achraf	MAR	35:38.50	+4:09.62	42.086
15	88	10017629530	MURN Bostjan	SLO	35:56.59	+4:27.71	41.733
16	52	10054904004	HABOURIA Maher	TUN	36:24.25	+4:55.37	41.204
17	14	10102045394	CAMPUBI PIJUAN Marcel	ESP	36:58.74	+5:29.86	40.564
18	57	10108107187	NOUISRI Ali	TUN	37:54.22	+6:25.34	39.574
19	93	10080684984	BADI Labib Tark	LBA	39:30.30	+8:01.42	37.970
20	94	10090537154	LAYTEEM Ans	LBA	39:43.90	+8:15.02	37.753
	96	10114894056	BONELLO Daniel Joseph	MLT	DNS		
	97	10078179960	BERLIN Antoine	MON	DNS		



Men - Time Trial  
Cycling Road  
Men's Time Trial  
Final



THU 30 JUN 2022

## Final Results

Start Time 11:00

Race distance: 25,00 km

Rank	Bib	UCI Code	Name	CTRY	Final Time	Time Behind	Average Speed
------	-----	----------	------	------	------------	-------------	---------------

Average Speed	Total Race Distance
47,647 km/h	25Km

Number of Entries 22  
Runners 20  
Did not Start 2  
Arrived 20

### LEGEND

DNF Did not Finish      DNS Did not start      DSQ Disqualified      OT Over time limit



## Entry List by Event

CTRY	Bib	UCI Code	Name	Date of Birth	Height m / ft in	Weight kg / lbs
ALG - Algeria	108	10099022634	HOUILI Nesrine	27 AUG 2003	1.75 / 5' 9"	60 / 132
CYP - Cyprus	118	10007704309	CHRISTOFOROU Antri	2 APR 1992	1.70 / 5' 7"	64 / 141
ESP - Spain	101	10011154475	ALONSO DOMINGUEZ Sandra	19 AUG 1998	1.78 / 5' 10"	63 / 139
	102	10043139621	BENITO PELLICER Mireia	30 DEC 1996	1.69 / 5' 7"	60 / 132
FRA - France	114	10067688095	KERBAOL Cedrine	15 MAY 2001	1.67 / 5' 6"	56 / 123
	115	10023522278	LE NET Marie	25 JAN 2000	1.73 / 5' 8"	62 / 137
GRE - Greece	128	10007934681	FASOI Varvara	2 FEB 1991	1.63 / 5' 4"	58 / 128
ITA - Italy	122	10008672689	FIDANZA Arianna	6 JAN 1995		
	125	10015339118	GUAZZINI Vittoria	26 DEC 2000		
POR - Portugal	143	10044087793	VOETS DE SOUSA Daniela Maria	31 MAR 2002	1.74 / 5' 9"	60 / 132
	141	10044298567	CARVALHO ROXO Beatriz Sofia	30 SEP 2003	1.73 / 5' 8"	63 / 139
SLO - Slovenia	133	10006412589	BUJAK Eugenia	25 JUN 1989	1.76 / 5' 9"	64 / 141
	135	10007859206	PINTAR Urska	3 OCT 1985	1.69 / 5' 7"	55 / 121

Total number of athletes: 13



THU 30 JUN 2022

## Start List

Start Time 10:00

Group	Start Time	Bib UCI Code	Name	CTRY	Date of Birth	Time
1	10:00	108 10099022634	HOUILI Nesrine	ALG	27 AUG 2003	
	10:03	128 10007934681	FASOI Varvara	GRE	2 FEB 1991	
	10:06	118 10007704309	CHRISTOFOROU Antri	CYP	2 APR 1992	
	10:09	102 10043139621	BENITO PELLICER Mireia	ESP	30 DEC 1996	
	10:12	115 10023522278	LE NET Marie	FRA	25 JAN 2000	
	10:15	122 10008672689	FIDANZA Arianna	ITA	6 JAN 1995	
	10:18	141 10044298567	CARVALHO ROXO Beatriz Sofia	POR	30 SEP 2003	
	10:21	135 10007859206	PINTAR Urska	SLO	3 OCT 1985	
	10:24	101 10011154475	ALONSO DOMINGUEZ Sandra	ESP	19 AUG 1998	
	10:27	114 10067688095	KERBAOL Cedrine	FRA	15 MAY 2001	
	10:30	125 10015339118	GUAZZINI Vittoria	ITA	26 DEC 2000	
	10:33	143 10044087793	VOETS DE SOUSA Daniela Maria	POR	31 MAR 2002	
	10:36	133 10006412589	BUJAK Eugenia	SLO	25 JUN 1989	
<b>Entries/CTRYs</b>						
13/16						18Km



THU 30 JUN 2022

## Final Results

Start Time 10:00

Race distance: 18,00 km

Rank	Bib	UCI Code	Name	CTRY	Final Time	Time Behind	Average Speed
1	125	10015339118	GUAZZINI Vittoria	ITA	24:24.40		44.250
2	133	10006412589	BUJAK Eugenia	SLO	25:14.20	+49.80	42.795
3	114	10067688095	KERBAOL Cedrine	FRA	25:52.77	+1:28.37	41.732
4	118	10007704309	CHRISTOFOROU Antri	CYP	26:06.33	+1:41.93	41.371
5	115	10023522278	LE NET Marie	FRA	26:08.17	+1:43.77	41.322
6	122	10008672689	FIDANZA Arianna	ITA	26:15.58	+1:51.18	41.128
7	135	10007859206	PINTAR Urska	SLO	26:23.44	+1:59.04	40.924
8	102	10043139621	BENITO PELLICER Mireia	ESP	26:25.28	+2:00.88	40.876
9	101	10011154475	ALONSO DOMINGUEZ Sandra	ESP	26:39.88	+2:15.48	40.503
10	143	10044087793	VOETS DE SOUSA Daniela Maria	POR	26:46.37	+2:21.97	40.339
11	128	10007934681	FASOI Varvara	GRE	28:01.44	+3:37.04	38.538
12	108	10099022634	HOUILI Nesrine	ALG	28:22.85	+3:58.45	38.054
13	141	10044298567	CARVALHO ROXO Beatriz Sofia	POR	30:15.29	+5:50.89	35.697

Average Speed	Total Race Distance
44,250 km/h	18Km

Number of Entries	13
Runners	13
Did not Start	0
Arrived	13

### LEGEND

DNF	Did not Finish	DNS	Did not start	DSQ	Disqualified	OT	Over time limit
-	-						



## Medal Standings

As of SAT 2 JUL 2022 at 19:34  
After 4 of 4 events

Rank	Country	Men				Women				Total				Rank by total
		G	S	B	Tot	G	S	B	Tot	G	S	B	Tot	
1	ITA - Italy					2			2	2			2	= 2
2	FRA - France	1	2	1	4			1	1	1	2	2	5	1
3	POR - Portugal	1			1		1		1	1	1		2	= 2
4	SLO - Slovenia						1		1		1		1	= 4
5	ESP - Spain							1	1			1	1	= 4
5	SRB - Serbia			1	1							1	1	= 4
	<b>Total:</b>	<b>2</b>	<b>2</b>	<b>2</b>	<b>6</b>	<b>2</b>	<b>2</b>	<b>2</b>	<b>6</b>	<b>4</b>	<b>4</b>	<b>4</b>	<b>12</b>	

### LEGEND

- -  
- -



ألعاب البحر الأبيض المتوسط  
MEDITERRANEAN GAMES  
JEUX MÉDITERRANÉENS  
du 25 juin au 06 juillet

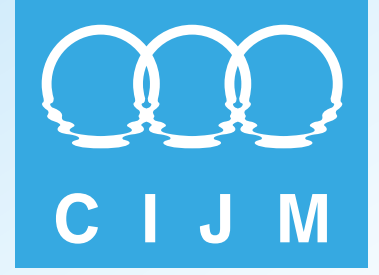

# Results Book



## Equestrian



**TOSYALI  
ALGERIE**

Fer et Acier

سوناطراي



sonarach



microplus  
DATA PROCESSING & TIMING  
[www.microplustiming.com](http://www.microplustiming.com)



ENTRY LIST BY COUNTRY

ALG			
Rider	Num.	Horse	
10067133	5	106RA18	CHADID D'HEM
10090145	7	106RA20	DINARD D'HEM
10036084	11	107KZ48	NELSON DU PETIT VIVIER
10036082	12	107RP00	TARIK D'HEM
10099221	23	106QZ87	DJAZZY DES FORETS

EGY			
Rider	Num.	Horse	
10092382	16	103TI92	COMME IL FAUT
10104499	18	107MW78	ZWIEBERTJE NCS Z
10021782	28	105JH58	DARSHAN
10137615	32	105EV92	MOROCCO
10072382	33	106SK23	KATIA

LBA			
Rider	Num.	Horse	
10202653	6	107UB16	TALIDA Z
10202652	8	107LA18	PRESTIGE NAJI
10042022	20	105OE95	FIGHTING DREAM R-E
10068075	24	104YY19	CAYA ROUGE

MAR			
Rider	Num.	Horse	
10159064	13	105QV01	FIRESTONE B
10093472	14	105NH12	BIANCA III
10081456	15	106FT61	HALLIFAX L
10112444	19	106FU53	CEIKA MALOUINE
10008056	25	105ZL28	BILBOT

MON			
Rider	Num.	Horse	
10017951	29	106ID41	IT'S MY LIFE

SYR			
Rider	Num.	Horse	
10150206	4	106HS77	CAMELIA DE LA VIGNE
10005827	3	106EK66	CABERNET DE MARS
10028625	1	104CA38	CALDERO
10069119	2	104CV19	CARAMIA 25

TUN			
Rider	Num.	Horse	
10156968	10	106PZ65	CHANEL DE LA VIE





ENTRY LIST BY COUNTRY

TUN			
Rider	Num.	Horse	
10089160	17	106AY14	BRASILIA DE L'ABBAYE
10104851	21	107ME22	EDELBERT DU HOUSOIT
10089158	30	105UB44	FLAIR V
10039453	31	106QK23	INDORADO.S

TUR			
Rider	Num.	Horse	
10097742	9	106PN51	CORTHAGOS 58
10002762	22	104YL50	CASSCORD
10097749	26	104HO65	CHAMP'S SON
10025812	27	105HD81	CANTAIRE O



## Medal Standings

As of SUN 3 JUL 2022 at 19:19  
After 1 of 1 events

Rank	Country	Men				Women				Total				Rank by total
		G	S	B	Tot	G	S	B	Tot	G	S	B	Tot	
1	SYR - Syrian Arab Republic									2	1		3	1
2	EGY - Egypt										1	1	2	2
3	TUR - Turkey											1	1	3
	<b>Total:</b>													

### LEGEND

- -  
- -



## Medallists

As of SUN 3 JUL 2022 at 18:55

Medal	Name	CTRY
GOLD	HAMCHO Ahmad Saber	SYR - Syrian Arab Republic
SILVER	GHARIB Chadi	SYR - Syrian Arab Republic
BRONZE	TALAAT Mohamed	EGY - Egypt



SUN 3 LUG 2022  
Start Time 3.00 p.m.



OFFICIAL RESULT

N.	Horse	Rider	Penalty	Time
1°	1 CALDERO 104CA38 - 14 cast. camaro m/(cortez)	 Ahmad Saber Hamcho 10028625	0/4/0 = 4	59,26
2°	3 CABERNET DE MARS 106EK66 - 10 cast. baloubet du rouet/(dollar dela pierre)	 Shady Ghrayeb 10005827	0/4/0 = 4	62,19
3°	28 DARSHAN 105JH58 - 11 stall. diamant de semilly/(baloubet du rouet)	 Mohamed Talaat 10021782	4/0/0 = 4	65,44
4°	27 CANTAIRE O 105HD81 - 15 cast. canturo/(voltaire)	 Hasan Senturk 10025812	5/4/0 = 9	65,26
5°	2 CARAMIA 25 104CV19 - 15 femm. hann chacco-blue/(almox prints j)	 Amre Hamcho 10069119	4/4/4 = 12	60,53
6°	30 FLAIR V 105UB44 - 12 femm. /()	 Omar Trabelsi 10089158	0/8/4 = 12	67,82
7°	5 CHADID D'HEM 106RA18 - 10 cast. ready boy des forets/()	 Brahim Ait Lounis 10067133	4/0/8 = 12	68,92
8°	31 INDORADO.S 106QK23 - 9 stall. /()	 Wael Trabelsi 10039453	8/5/0 = 13	67,89
9°	7 DINARD D'HEM 106RA20 - 9 stall. /()	 Sid Ali Allali 10090145	8/0/5 = 13	70,08
10°	14 BIANCA III 105NH12 - 13 femm. casall/()	 Samy Colman 10093472	0/12/1 = 13	70,55
11°	26 CHAMP'S SON 104HO65 - 14 cast. cavalor cumano/(linaro)	 Ozgur Ozkan 10097749	10/0/4 = 14	67,18
12°	33 KATIA 106SK23 - 9 femm. kwpn emerald/(lancelot)	 Mouda Zeyada 10072382	0/12/4 = 16	63,05
13°	29 IT'S MY LIFE 106ID41 - 9 cast. kwpn calvino z/(tangelo van de zuuthoeve)	 Wenceslas Thomel 10017951	4/8/4 = 16	67,91
14°	19 CEIKA MALOUINE 106FU53 - 10 femm. /()	 Hicham Er-Radi 10112444	8/5/4 = 17	64,62
15°	8 PRESTIGE NAJI 107LA18 - 7 femm. /()	 Abduljawad Almusrati 10202652	11/5/4 = 20	66,88
16°	32 MOROCCO 105EV92 - 14 stall. hann for edition/(wanderer)	 Mohamed Weaam 10137615	8/10/4 = 22	65,62
17°	17 BRASILIA DE L'ABBAYE 106AY14 - 11 stall. /()	 Ghazi Ellouze 10089160	14/4/4 = 22	68,18
18°	9 CORTHAGOS 58 106PN51 - 10 cast. /()	 Ahmet Berk Basegmez 10097742	10/8/6 = 24	75,25
19°	16 COMME IL FAUT 103TI92 - 15 stall. kwpn diamant de semilly/(equest carnute)	 Mohamed El Naggar 10092382	12/4/12 = 28	73,17
20°	11 NELSON DU PETIT VIVIER 107KZ48 - 9 stall. /()	 Abdelkader Benharrats 10036084	9/14/8 = 31	69,33
21°	22 CASSCORD 104YL50 - 13 cast. casall/(corrado i)	 Ihsan Sencer Horasan 10002762	14/26/9 = 49	74,39
22°	21 EDELBERT DU HOUSOIT 107ME22 - 12 stall. /()	 Mohamed Guizani 10104851	48/16/4 = 68	67,31
23°	23 DJAZZY DES FORETS 106QZ87 - 9 stall. mozart des hayettes/()	 Mohamed Mesrati 10099221	12/8/Elim = 20	
24°	20 FIGHTING DREAM R-E 105OE95 - 12 femm. kwpn /()	 Abdul Fatah Militan 10042022	14/10/Rit = 24	
25°	15 HALLIFAX L 106FT61 - 10 stall. /()	 Majid Djaidi 10081456	22/11/Elim. = 33	
26°	25 BILBOT 105ZL28 - 11 cast. quickly de kreisker/(fergar mail)	 Abdelkebir Ouaddar 10008056	32/2/Elim. = 34	
27°	24 CAYA ROUGE 104YY19 - 15 femm. kwpn wittinger vdl/(converter)	 Abdulwahab Mlitan 10068075	36/12/Elim. = 48	



SUN 3 LUG 2022  
Start Time 3.00 p.m.

OFFICIAL RESULT

	N.	Horse	Rider	Penalty	Time
28°	6	<b>TALIDA Z</b> 107UB16 - 12 femm. /()	 <b>Mahmoud Ali</b> LBA 10202653	36/16/Rit = 52	
n.c.	4	<b>CAMELIA DE LA VIGNE</b> 106HS77 - 10 femm. corofino*gfe/(diamant de semilly)	 <b>Laith Ali</b> SYR 10150206	Elim.	



SUN 3 LUG 2022  
Start Time 3.00 p.m.

STARTING LIST

N.	Horse	Rider	Result
1.	21 EDELBERT DU HOUSOIT BEL 107ME22 stall.2010 /()	MOHAMED GUIZANI	48,00
2.	24 CAYA ROUGE NED 104YY19 femm.2007 KWPN wittinger vdl/(converter)	ABDULWAHAB MLITAN	36,00
3.	6 TALIDA Z BEL 107UB16 femm.2010 /()	MAHMOUD ALI	36,00
4.	25 BILBOT FRA 105ZL28 cast.2011 quickly de kreisker/(fergar mail)	ABDELKEBIR OUADDAR	32,00
5.	15 HALLIFAX L NED 106FT61 stall.2012 /()	MAJID DJAIDI	22,00
6.	22 CASSCORD GER 104YL50 cast.2009 casall/(corrado i)	IHSAN SENCER HORASAN	14,00
7.	17 BRASILIA DE L'ABBAYE FRA 106AY14 stall.2011 /()	GHAZI ELLOUZE	14,00
8.	20 FIGHTING DREAM R-E NED 105OE95 femm.2010 KWPN /()	ABDUL FATAH MILITAN	14,00
9.	16 COMME IL FAUT NED 103TI92 stall.2007 KWPN diamant de semilly/(equest carnute	MOHAMED EL NAGGAR	12,00
15 min.Break			
10.	23 DJAZZY DES FORETS ALG 106QZ87 stall.2013 mozart des hayettes/()	MOHAMED MESRATI	12,00
11.	8 PRESTIGE NAJI BEL 107LA18 femm.2015 /()	ABDULJAWAD ALMUSRATI	11,00
12.	26 CHAMP'S SON GER 104HO65 cast.2008 cavalor cumano/(linaro)	OZGUR OZKAN	10,00
13.	9 CORTHAGOS 58 GER 106PN51 cast.2012 /()	AHMET BERK BASEGMEZ	10,00
14.	11 NELSON DU PETIT VIVIER BEL 107KZ48 stall.2013 /()	ABDELKADER BENHARRATS	9,00
15.	31 INDORADO,S NED 106QK23 stall.2013 /()	WAEL TRABELSI	8,00
16.	19 CEIKA MALOUINE FRA 106FU53 femm.2012 /()	HICHAM ER-RADI	8,00
17.	32 MOROCCO GER 105EV92 stall.2008 HANN for edition/(wanderer)	MOHAMED WEAAM	8,00
18.	7 DINARD D'HEM ALG 106RA20 stall.2013 /()	SID ALI ALLALI	8,00
15 min.Break			
19.	27 CANTAIRE O NED 105HD81 cast.2007 canturo/(voltaire)	HASAN SENTURK	5,00
20.	29 IT'S MY LIFE NED 106ID41 cast.2013 KWPN calvino z/(tangelo van de zuuthoe	WENCESLAS THOMEL	4,00
21.	2 CARAMIA 25 GER 104CV19 femm.2007 HANN chacco-blue/(almox prints j)	AMRE HAMCHO	4,00
22.	28 DARSHAN FRA 105JH58 stall.2011 diamant de semilly/(baloubet du rouet)	MOHAMED TALAAT	4,00
23.	5 CHADID D'HEM ALG 106RA18 cast.2012 ready boy des forets/()	BRAHIM AIT LOUNIS	4,00
24.	3 CABERNET DE MARS FRA 106EK66 cast.2012 baloubet du rouet/(dollar dela pierre)	SHADY GHRAYEB	0,00
25.	14 BIANCA III NED 105NH12 femm.2009 casall/()	SAMY COLMAN	0,00
26.	30 FLAIR V NED 105UB44 femm.2010 /()	OMAR TRABELSI	0,00
27.	1 CALDERO SWE 104CA38 cast.2008 camaro m/(cortez)	AHMAD SABER HAMCHO	0,00
28.	33 KATIA NED 106SK23 femm.2013 KWPN emerald/(lancelot)	MOUDA ZEYADA	0,00



FRI 1 LUG 2022  
Start Time 4.00 p.m.

## Medallists

Medal	CTRY	Name
GOLD	SYR - Syrian Arab Republic	ALI Laith GHARIB Chadi HAMCHO Ahmad Saber HAMCHO Amre
SILVER	EGY - Egypt	EL NAGGAR Mohamed TALAAT Mohamed WEAAM Mohamed ZEYADA Mouda
BRONZE	TUR - Turkey	BASEGMEZ Ahmet Berk HORASAN Sencer OZKAN Ozgur SENTURK Hasan



FRI 1 LUG 2022  
Start Time 4.00 p.m.

OFFICIAL RESULT

N.	Horse	Rider	Penalty			Time
<b>1°</b>	<b>SYRIAN ARAB REP. SYRIAN</b> (Chef d'Equipe:Al Zaibak Atef )		<b>4</b>			
			0	4	0	
2	<b>CARAMIA 25</b> 104CV19 - 15 femm. hann chacco-blue/(almox prints j)	<b>Amre Hamcho</b> 10069119	0	4	0	
1	<b>CALDERO</b> 104CA38 - 14 cast. camaro m/(cortez)	<b>Ahmad Saber Hamcho</b> 10028625	0	0		
4	<b>CAMELIA DE LA VIGNE</b> 106HS77 - 10 femm. corofino"gfe/(diamant de semilly)	<b>Laith Ali</b> 10150206	(1)	(Elim)		
3	<b>CABERNET DE MARS</b> 106EK66 - 10 cast. baloubet du rouet/(dollar dela pierre)	<b>Shady Ghayeb</b> 10005827	0	0		
<b>2°</b>	<b>EGYPT</b> ( Chef d'Equipe:Ahmed Nabil Rached )		<b>11</b>			
			7	4		
33	<b>KATIA</b> 106SK23 - 9 femm. kwpn emerald/(lancelot)	<b>Mouda Zeyada</b> 10072382	0	0	0	
32	<b>MOROCCO</b> 105EV92 - 14 stall. hann for edition/(wanderer)	<b>Mohamed Weaam</b> 10137615	(4)	4		
16	<b>COMME IL FAUT</b> 103TI92 - 15 stall. kwpn diamant de semilly/(equest carnute)	<b>Mohamed El Naggar</b> 10092382	3	(9)		
28	<b>DARSHAN</b> 105JH58 - 11 stall. diamant de semilly/(baloubet du rouet)	<b>Mohamed Talaat</b> 10021782	4	0		
<b>3°</b>	<b>TURKIYE</b> ( Chef d'Equipe:Sencer Horasan )		<b>21</b>			
			1	20		41,90
27	<b>CANTAIRE O</b> 105HD81 - 15 cast. canturo/(voltaire)	<b>Hasan Senturk</b> 10025812	1	4	4	41.90
26	<b>CHAMP'S SON</b> 104HO65 - 14 cast. cavalor cumano/(linaro)	<b>Ozgun Ozkan</b> 10097749	0	10		
9	<b>CORTHAGOS 58</b> 106PN51 - 10 cast. /()	<b>Ahmet Berk Basegmez</b> 10097742	(4)	6		
22	<b>CASSCORD</b> 104YL50 - 13 cast. casall/(corrado i)	<b>Ihsan Sencer Horasan</b> 10002762	0	(14)		
<b>4°</b>	<b>ALGERIA</b> ( Chef d'Equipe:Lamine Semra )		<b>21</b>			36,93
			9	12		
5	<b>CHADID D'HEM</b> 106RA18 - 10 cast. ready boy des forets/()	<b>Brahim Ait Lounis</b> 10067133	0	(4)	8	36.93
7	<b>DINARD D'HEM</b> 106RA20 - 9 stall. /()	<b>Sid Ali Allali</b> 10090145	4	4		
11	<b>NELSON DU PETIT VIVIER</b> 107KZ48 - 9 stall. /()	<b>Abdelkader Benharrats</b> 10036084	5	4		
23	<b>DJAZZY DES FORETS</b> 106QZ87 - 9 stall. mozart des hayettes/()	<b>Mohamed Mesrati</b> 10099221	(8)	4		
<b>5°</b>	<b>TUNISIA</b> ( Chef d'Equipe:Zied Aouina )		<b>22</b>			J.O.
			9	13		
31	<b>INDORADO S</b> 106QK23 - 9 stall. /()	<b>Wael Trabelsi</b> 10039453	0	8		
21	<b>EDELBERT DU HOUSOIT</b> 107ME22 - 12 stall. /()	<b>Mohamed Guizani</b> 10104851	(13)	(35)		
30	<b>FLAIR V</b> 105UB44 - 12 femm. /()	<b>Omar Trabelsi</b> 10089158	0	0		
17	<b>BRASILIA DE L'ABBAYE</b> 106AY14 - 11 stall. /()	<b>Ghazi Ellouze</b> 10089160	9	5		





FRI 1 LUG 2022  
Start Time 4.00 p.m.

OFFICIAL RESULT

N.	Horse	Rider	Penalty		Time			
			26	4				
<b>6°</b>	<b>MOROCCO</b>	( Chef d'Equipe:Philippe Le Jeune )	<b>30</b>		J.O.			
			<b>25</b>	<b>BILBOT</b> 105ZL28 - 11 cast. quickly de kreisker/(fergar mail)	<b>Abdelkebir Ouaddar</b> 10008056	<b>(23)</b>	<b>(9)</b>	
			<b>19</b>	<b>CEIKA MALOUINE</b> 106FU53 - 10 femm. /()	<b>Hicham Er-Radi</b> 10112444	<b>4</b>	<b>4</b>	
			<b>15</b>	<b>HALLIFAX L</b> 106FT61 - 10 stall. /()	<b>Majid Djaidi</b> 10081456	<b>22</b>	<b>0</b>	
			<b>14</b>	<b>BIANCA III</b> 105NH12 - 13 femm. casall/()	<b>Samy Colman</b> 10093472	<b>0</b>	<b>0</b>	
<b>7°</b>	<b>LIBYA</b>	( Chef d'Equipe:Abdom Agid )	<b>56</b>		J.O.			
			<b>8</b>	<b>PRESTIGE NAJI</b> 107LA18 - 7 femm. /()	<b>Abduljawad Almusrati</b> 10202652	<b>7</b>	<b>4</b>	
			<b>6</b>	<b>TALIDA Z</b> 107UB16 - 12 femm. /()	<b>Mahmoud Ali</b> 10202653	<b>16</b>	<b>(20)</b>	
			<b>24</b>	<b>CAYA ROUGE</b> 104YY19 - 15 femm. kwpn wittinger vdl/(converter)	<b>Abdulwahab Mlitan</b> 10068075	<b>(21)</b>	<b>15</b>	
			<b>20</b>	<b>FIGHTING DREAM R-E</b> 105OE95 - 12 femm. kwpn /()	<b>Abdul Fatah Militan</b> 10042022	<b>10</b>	<b>4</b>	
<b>8°</b>	<b>MONACO</b>		<b>4</b>		J.O.			
			<b>29</b>	<b>IT'S MY LIFE</b> 106ID41 - 9 cast. kwpn calvino z/(tangelo van de zuuthoeve)	<b>Wenceslas Thomel</b> 10017951	<b>1</b>	<b>3</b>	



FRI 1 LUG 2022  
Start Time 4.00 p.m.

STARTING LIST (TEAM ORDER)

N.	Horse	Rider	Result
<b>1. SYR - SYRIAN ARAB REPUBLIC</b> ( Chef d'Equipe:Al Zaibak Atef )			
2	CARAMIA 25 CARAMIA 25 femm.2007 HANN chacco-blue/(almox prints j)	AMRE HAMCHO	
1	CALDERO CALDERO cast.2008 camaro m/(cortez)	AHMAD SABER HAMCHO	
4	CAMELIA DE LA VIGNE CAMELIA DE LA VIGNE femm.2012 corofino*gfe/(diamant de s	LAITH ALI	
3	CABERNET DE MARS CABERNET DE MARS cast.2012 baloubet du rouet/(dollar dela	SHADY GHAYEB	
<b>2. TUR - TURKEY</b> ( Chef d'Equipe:Sencer Horasan )			
27	CANTAIRE O CANTAIRE O cast.2007 canturo/(voltaire)	HASAN SENTURK	
26	CHAMP'S SON CHAMP'S SON cast.2008 cavalor cumano/(linaro)	OZGUR OZKAN	
9	CORTHAGOS 58 CORTHAGOS 58 cast.2012 /()	AHMET BERK BASEGMEZ	
22	CASSCORD CASSCORD cast.2009 casall/(corrado i)	IHSAN SENCER HORASAN	
<b>3. MON - MONACO</b>			
29	IT'S MY LIFE IT'S MY LIFE cast.2013 KWPN calvino z/(tangelo van de zuuthoev	WENCESLAS THOMEL	
<b>4. EGY - EGYPT</b> ( Chef d'Equipe:Ahmed Nabil Rached )			
33	KATIA KATIA femm.2013 KWPN emerald/(lancelot)	MOUDA ZEYADA	
32	MOROCCO MOROCCO stall.2008 HANN for edition/(wanderer)	MOHAMED WEAAM	
16	COMME IL FAUT COMME IL FAUT stall.2007 KWPN diamant de semilly/(equest car	MOHAMED EL NAGGAR	
28	DARSHAN DARSHAN stall.2011 diamant de semilly/(baloubet du rouet)	MOHAMED TALAAT	
<b>5. ALG - ALGERIA</b> ( Chef d'Equipe:Lamine Semra )			
5	CHADID D'HEM CHADID D'HEM cast.2012 ready boy des forets/()	BRAHIM AIT LOUNIS	
7	DINARD D'HEM DINARD D'HEM stall.2013 /()	SID ALI ALLALI	
11	NELSON DU PETIT VIVIER NELSON DU PETIT VIVIER stall.2013 /()	ABDELKADER BENHARRATS	
23	DJAZZY DES FORETS DJAZZY DES FORETS stall.2013 mozart des hayettes/()	MOHAMED MESRATI	
<b>6. TUN - TUNISIA</b> ( Chef d'Equipe:Zied Aouina )			
31	INDORADO.S INDORADO.S stall.2013 /()	WAEI TRABELSI	
21	EDELBERT DU HOUSOIT EDELBERT DU HOUSOIT stall.2010 /()	MOHAMED GUIZANI	
30	FLAIR V FLAIR V femm.2010 /()	OMAR TRABELSI	
17	BRASILIA DE L'ABBAYE BRASILIA DE L'ABBAYE stall.2011 /()	GHAZI ELLOUZE	
<b>7. LBA - LIBYA</b> ( Chef d'Equipe:Abdom Agid )			
8	PRESTIGE NAJI PRESTIGE NAJI femm.2015 /()	ABDULJAWAD ALMUSRATI	
6	TALIDA Z TALIDA Z femm.2010 /()	MAHMOUD ALI	
24	CAYA ROUGE CAYA ROUGE femm.2007 KWPN wittinger vdl/(converter)	ABDULWAHAB MLITAN	
20	FIGHTING DREAM R-E FIGHTING DREAM R-E femm.2010 KWPN /()	ABDUL FATAH MILITAN	



FRI 1 LUG 2022  
Start Time 4.00 p.m.

**STARTING LIST (TEAM ORDER)**

N.	Horse	Rider	Result
8.	 <b>MAR - MOROCCO</b>	( Chef d'Equipe:Philippe Le Jeune )	
25	BILBOT BILBOT cast.2011 quickly de kreisker/(fergar mail)	ABDELKEBIR OUADDAR	
19	CEIKA MALOUINE CEIKA MALOUINE femm.2012 /()	HICHAM ER-RADI	
15	HALLIFAX L HALLIFAX L stall.2012 /()	MAJID DJAIDI	
14	BIANCA III BIANCA III femm.2009 casall/()	SAMY COLMAN	



ألعاب البحر الأبيض المتوسط  
MEDITERRANEAN GAMES  
JEUX MÉDITERRANÉENS  
du 25 juin au 06 juillet

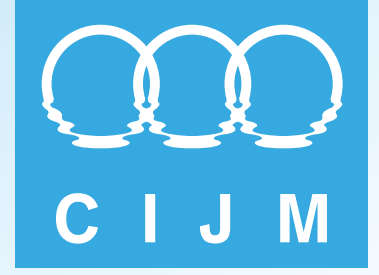

# Results Book



## Football



**TOSYALI  
ALGERIE**

Fer et Acier

سوناطراي



sonarach



microplus  
DATA PROCESSING & TIMING  
[www.microplustiming.com](http://www.microplustiming.com)



## Medallists

As of MON 4 JUL 2022 at 23:31

Gold	Silver	Bronze
<b>FRA - France</b>	<b>ITA - Italy</b>	<b>MAR - Morocco</b>
1 PATOUILLET Mathieu Franck	1 MASTRANTONIO Davide	1 MAGO Elias
2 LOUIS-JEAN Johaneko Henri	2 MISSORI Filippo	2 LANTAKI Wassim
3 KABA Kanfory	3 REGONESI Iacopo	3 AKHARRAZ Youness
4 MERCIER Kevin Mathis	4 PALELLA Andrea	4 AMMAL Abdessamad
5 CHIESA Ange	5 DELLAVALLE Lorenzo	5 EL HAMMAMI Ayoub
6 BUAYI KIALA Nathan	6 INDRAGOLI Gabriele	6 BAALLAL Abdellah
7 PIRRINGUEL Lenny Seive	7 HASA Luis	7 LYAKOUBI Oussama
8 DOUMBIA Cheick Mohamed	8 KUMI Justin	8 JAZOULI Mohammed Younes
9 KANOUTE Mahamadou	9 MANCINI Tommaso	9 SADIK Omar
10 BELAHYANE Reda	10 ACCORNERO Federico	10 ARHOUN Usama
11 BACAHA Mohamed Adel	11 PATANE' Nicola	11 MAURER Aiman
12 BOLUMBU SOMBO Diabe Ousmane Cothy	12 BAGNOLINI Nicola	12 HASBI Walid
13 EL HANNACH Younes Mohamed	13 BOZZOLAN Andrea	13 KHATIR Ahmed
14 BONGEMBA Edvin	14 GUARINO Gabriele	14 ANHARI Hamza
15 BOUANANI Badredine	15 AMATUCCI Lorenzo	15 BOUKHRES Othmane
16 ZADI Alain Georges	16 IGNACCHITI Lorenzo	16 TAMOUNE Anouar Khalid
17 MESSOUSSA Amine Abdelrahmane	17 D'ANDREA Luca	17 RAIHANI Abdellah
18 IKIA DIMI Yvan Junior	18 RAIMONDO Antonio	18 KHALIFI Yassine



## Final Standings

As of MON 4 JUL 2022 at 23:29

Medal	Rank	Team
Gold	1	FRA - France
Silver	2	ITA - Italie
Bronze	3	MAR - Maroc
	4	TUR - Turquie
	5	ALG - Algérie
	5	POR - Portugal
	7	GRE - Grèce
	7	ESP - Espagne



## Team Roster

As of SAT 25 JUN 2022 at 23:21

### ALG - Algeria

No.	Name	Shirt Name	Pos	Height m/f	Date of Birth	Age	Club
	ABDELKADER Mohamed Islem	ABDELKADER		1.75 / 5 ' 9	6 FEB 2004	18	
	AID Al Amin Mohamed				30 SEP 2007	14	
	AKHRIB Lahlou			1.75 / 5 ' 9	24 APR 2005	17	
	BEN MAZOUZ Mohamed Said			1.75 / 5 ' 9	22 MAR 2004	18	
	BOUALAM Hamza			1.75 / 5 ' 9	20 SEP 2004	17	
	BOUMENGOUCHE Abdelaziz C			1.75 / 5 ' 9	8 FEB 2004	18	
	BOUNACER Abdessamed			1.75 / 5 ' 9	11 DEC 2004	17	
	BOUZAHZAH Ouanisse			1.75 / 5 ' 9	7 OCT 2004	17	
	CHEGRA Ivane			1.75 / 5 ' 9	3 MAR 2004	18	
	DJADI Adam Ghybril			1.75 / 5 ' 9	30 MAR 2004	18	
	DOUGUI Adam			1.75 / 5 ' 9	20 APR 2004	18	
	HANFOUG Fouad			1.75 / 5 ' 9	23 JAN 2004	18	
	LAALLAM Abdelghani			1.75 / 5 ' 9	6 JUL 2004	17	
	NOTTEBAERE Djibril			1.75 / 5 ' 9	28 DEC 2004	17	
	OMAR Mohamed Rafik			1.75 / 5 ' 9	10 JAN 2004	18	
	PUCH-HERRANTZ Mehdi Guillermo Moh			1.75 / 5 ' 9	20 JAN 2004	18	
	ZAOUI Salah Eddine			1.75 / 5 ' 9	25 APR 2004	18	
	ZULLIANI Edhy Yvan			1.75 / 5 ' 9	11 AUG 2004	17	
	<b>Team averages</b>			1.75 / 5 ' 9		17.4	

Coach	SLATNI Mourad
Coach	IKHLEF Kamel
Coach	HALEM Ahmed
Coach	ACIMI Mohammed Reda

#### LEGEND

DF	Defender	FW	Forward	GK	Goalkeeper	MF	Midfielder
No.	Shirt Number	Pos	Position				



## Team Roster

As of SAT 25 JUN 2022 at 23:21

### ESP - Spain

No.	Name	Shirt Name	Pos	Height m/f	Date of Birth	Age	Club
	FRESNEDA CORRALIZA Ivan			1.80 / 5 ' 1	28 SEP 2004	17	
1	ASTRALAGA ARANGUREN Ander	ASTRAGALA	GK	1.89 / 6 ' 2	3 MAR 2004	18	FC BARCELONA, BARCELONA (ESP)
2	ALEMAN CASTILLO Carlos	C. ALEMAN	DF	1.78 / 5 ' 1	30 SEP 2004	17	RCD ESPANYOL DE B., BARCELONA (ESP)
4	MOSQUERA IBARGUEN Cristhian Andrey	CRISTHIAN	DF	1.89 / 6 ' 2	27 JUN 2004	17	VALENCIA CF, VALENCIA (ESP)
5	CASAS ARCAS Arnau	A.CASAS	DF	1.80 / 5 ' 1	30 MAR 2004	18	FC BARCELONA, BARCELONA (ESP)
6	MARTINEZ SANTAMARIA Roger	ROGER	MF	1.77 / 5 ' 1	5 APR 2004	18	RCD ESPANYOL DE B., BARCELONA (ESP)
7	BLANCO GOMEZ Fabio	FABIO	FW	1.77 / 5 ' 1	18 FEB 2004	18	FC BARCELONA, BARCELONA (ESP)
8	MORAN IBANEZ Manuel Angel	MANUEL ANGEL	MF	1.70 / 5 ' 7	15 MAR 2004	18	REAL MADRID, MADRID (ESP)
9	DENIA DIAZ Marcos	DENIA	FW	1.78 / 5 ' 1	23 MAR 2004	18	ATLETICO DE MADRID, MADRID (ESP)
10	GUERRERO LANDABASO Julen Jon	JULEN JON	MF	1.86 / 6 ' 1	14 APR 2004	18	REAL MADRID, MADRID (ESP)
11	EL JEBARI Salim	EL JEBARI	FW	1.77 / 5 ' 1	5 FEB 2004	18	ATLETICO DE MADRID, MADRID (ESP)
12	RODRIGUEZ MUNOZ Alvaro Daniel	ALVARO	FW	1.92 / 6 ' 4	14 JUL 2004	17	REAL MADRID, MADRID (ESP)
13	FERNANDEZ GONZALEZ Cesar	CESAR	GK	1.81 / 5 ' 1	28 JAN 2004	18	RC CELTA DE VIGO, VIGO (ESP)
14	BASTIDA MOYA Alvaro	BASTIDA	MF	1.80 / 5 ' 1	12 MAY 2004	18	CADIZ CF, CADIZ (ESP)
15	MENDES MENDES Tomas	T.MENDES	MF	1.87 / 6 ' 2	21 NOV 2004	17	DEPORTIVO ALAVES, VITORIA (ESP)
16	VALLE GOMEZ Alex	ALEX VALLE	DF	1.79 / 5 ' 1	25 APR 2004	18	FC BARCELONA, BARCELONA (ESP)
17	GHARBI ALVAREZ Ismael	GHARBI	MF	1.68 / 5 ' 6	10 APR 2004	18	PARIS ST. GERMAIN, PARIS (FRA)
18	PUJOL PORTORREAL Edgar Climent	EDGAR	DF	1.77 / 5 ' 1	7 AUG 2004	17	REAL MADRID, MADRID (ESP)
				<b>Team averages</b>	1.80 / 5 ' 1	17.7	

Coach

AMO AGUADO Pablo

#### LEGEND

DF	Defender	FW	Forward	GK	Goalkeeper	MF	Midfielder
No.	Shirt Number	Pos	Position				





## Team Roster

As of SAT 25 JUN 2022 at 23:21

FRA - France

No.	Name	Shirt Name	Pos	Height m/f	Date of Birth	Age	Club
	BACHA Mohamed Adel			1.69 / 5' 7	17 MAY 2004	18	
	BELAHYANE Reda				1 JUN 2004	18	
	BOLUMBU SOMBO Diabe Ousmane Cothy				12 JUL 2004	17	
	BONGEMBA Edvin				14 JAN 2004	18	
	BOUANANI Badredine				8 DEC 2004	17	
	BUAYI KIALA Nathan				29 FEB 2004	18	
	CHIESA Ange				10 MAY 2004	18	
	DOUMBIA Cheick Mohamed				18 OCT 2004	17	
	EL HANNACH Younes Mohamed				4 JUN 2004	18	
	IKIA DIMI Yvan Junior				26 SEP 2004	17	
	KABA Kanfory				23 MAR 2004	18	
	KANOUTE Mahamadou				24 JAN 2004	18	
	LOUIS-JEAN Johaneke Henri				28 JUN 2004	17	
	MERCIER Kevin Mathis				28 FEB 2004	18	
	MESSOUSSA Amine Abdelrahmane				12 OCT 2004	17	
	PATOUILLET Mathieu Franck				20 FEB 2004	18	
	PIRRINGUEL Lenny Seive				2 MAR 2004	18	
	ZADI Alain Georges				10 MAR 2004	18	
	<b>Team averages</b>			1.69 / 5' 7		17.7	

Coach LAUZUN Laurent Maurice  
 Coach MICONNET Aurelien  
 Coach RUSTERUCCI Ghjuvan-Simonu

### LEGEND

DF Defender      FW Forward      GK Goalkeeper      MF Midfielder  
 No. Shirt Number      Pos Position



## Team Roster

As of SAT 25 JUN 2022 at 23:21

### GRE - Greece

No.	Name	Shirt Name	Pos	Height m/f	Date of Birth	Age	Club
	GKOLFINOS Alexios			1.84 / 6' 0	24 NOV 2004	17	
	KOTTAS Dimitrios				14 JAN 2005	17	
1	BOTIS Nikolaos Nestoras		GK	1.95 / 6' 5	31 MAR 2004	18	INTERNAZIONALE, MILAN
3	TASIOURAS Eleftherios		DF	1.73 / 5' 8	1 MAR 2004	18	PAOK, THESSALONIKI (GRE)
4	KERAMITSIS Dimitrios		DF	1.93 / 6' 4	1 JUL 2004	17	AS ROMA, ROME (ITA)
5	CHRISTOU Nikolaos		DF	1.79 / 5' 1	26 JAN 2004	18	OLYMPIAKOS, PIRAEUS (GRE)
6	KYRIOPOULOS Georgios		MF	1.75 / 5' 9	24 AUG 2004	17	PANATHINAIKOS, ATHENS (GRE)
7	TSIKOS Zisis		MF	1.70 / 5' 7	13 JUN 2004	18	PAOK, THESSALONIKI (GRE)
9	MINA Leonidas		FW	1.82 / 6' 0	28 MAR 2004	18	PAS GIANNINA, IOANNINA (GRE)
10	KOUTSIAS Georgios		FW	1.80 / 5' 1	8 FEB 2004	18	PAOK, THESSALONIKI (GRE)
11	VOLAKIS Konstantinos		MF	1.73 / 5' 8	22 OCT 2004	17	PANATHINAIKOS, ATHENS (GRE)
12	MONASTIRLIS Dimitrios		GK	1.90 / 6' 3	22 MAR 2004	18	PAOK, THESSALONIKI (GRE)
14	GEORGIADIS Charalampos		DF	1.82 / 6' 0	26 MAR 2005	17	PAOK, THESSALONIKI (GRE)
15	PRODROMITIS Athanasios		DF	1.89 / 6' 2	29 FEB 2004	18	PANATHINAIKOS, ATHENS (GRE)
16	SYMEONIDIS Anastasios		MF	1.74 / 5' 9	6 JUL 2004	17	PANATHINAIKOS, ATHENS (GRE)
17	SMYRLIS Lampros		MF	1.72 / 5' 8	12 JUL 2004	17	PAOK, THESSALONIKI (GRE)
18	GKITERSOS Ioannis		FW	1.86 / 6' 1	23 MAY 2005	17	PAOK, THESSALONIKI (GRE)
19	FILON Marios Taxiarchis		DF	1.77 / 5' 1	16 MAR 2005	17	PAOK, THESSALONIKI (GRE)
<b>Team averages</b>				1.81 / 5' 1		17.4	

Coach THEOS Anastasios  
Coach ALEXIADIS Alexandros

#### LEGEND

DF Defender      FW Forward      GK Goalkeeper      MF Midfielder  
No. Shirt Number      Pos Position



## Team Roster

As of SAT 25 JUN 2022 at 23:21

### ITA - Italy

No.	Name	Shirt Name	Pos	Height m/f	Date of Birth	Age	Club
	BAGNOLINI Nicola				14 MAR 2004	18	
	D'ANDREA Luca				6 SEP 2004	17	
	INDRAGOLI Gabriele				20 FEB 2004	18	
	PATANE' Nicola				25 MAR 2004	18	
1	MASTRANTONIO Davide		GK		16 JAN 2004	18	AS ROMA, ROMA (ITA)
2	MISSORI Filippo		DF		24 MAR 2004	18	AS ROMA, ROMA (ITA)
3	REGONESI Iacopo		DF		28 MAR 2004	18	ATALANTA BERGAMASCA CALCIO, BERGA
4	PALELLA Andrea		MF		27 JUN 2004	17	GENOA CRICKET AND FC, GENOVA (ITA)
5	DELLAVALLE Lorenzo		DF		4 APR 2004	18	FC JUVENTUS, TORINO (ITA)
7	HASA Luis		MF		6 JAN 2004	18	FC JUVENTUS, TORINO (ITA)
8	KUMI Justin		MF	1.77 / 5' 1	16 JUL 2004	17	US SASSUOLO CALCIO, SASSUOLO (ITA)
9	MANCINI Tommaso		FW		23 JUL 2004	17	LR VICENZA, VICENZA (ITA)
13	BOZZOLAN Andrea		DF		23 FEB 2004	18	AC MILAN, MILANO (ITA)
14	GUARINO Gabriele		DF		14 APR 2004	18	EMPOLI FBC, EMPOLI (ITA)
15	AMATUCCI Lorenzo		MF		5 FEB 2004	18	ACF FIORENTINA, FIRENZE (ITA)
16	IGNACCHITI Lorenzo		MF		25 APR 2004	18	EMPOLI FBC, EMPOLI (ITA)
17	ACCORNERO Federico		MF		5 FEB 2004	18	GENOA CRICKET AND FC, GENOVA (ITA)
18	RAIMONDO Antonio		FW		18 MAR 2004	18	BOLOGNA FC 1909, BOLOGNA (ITA)
<b>Team averages</b>				1.77 / 5' 1		17.8	

Coach	VARESCO Nicola
Coach	BARELLA Matteo
Coach	CAPODICI Fabrizio
Coach	FRANCESCHINI Daniele

#### LEGEND

DF	Defender	FW	Forward	GK	Goalkeeper	MF	Midfielder
No.	Shirt Number	Pos	Position				



## Team Roster

As of SAT 25 JUN 2022 at 23:21

### MAR - Morocco

No.	Name	Shirt Name	Pos	Height m/f	Date of Birth	Age	Club
	AKHARRAZ Youness			1.80 / 5' 1	4 MAY 2004	18	
	AMMAL Abdessamad			1.80 / 5' 1	19 AUG 2004	17	
	ANHARI Hamza			1.80 / 5' 1	30 JAN 2004	18	
	ARHOUN Usama			1.80 / 5' 1	7 MAR 2004	18	
	BAALLAL Abdellah			1.80 / 5' 1	7 NOV 2004	17	
	BOUKHRES Othmane			1.80 / 5' 1	12 SEP 2004	17	
	EL HAMMAMI Ayoub			1.80 / 5' 1	1 FEB 2004	18	
	HASBI Walid			1.80 / 5' 1	7 JAN 2004	18	
	JAZOULI Mohammed Younes			1.80 / 5' 1	4 JUL 2005	16	
	KHALIFI Yassine			1.80 / 5' 1	9 AUG 2005	16	
	KHATIR Ahmed			1.80 / 5' 1	14 MAR 2005	17	
	LANTAKI Wassim			1.80 / 5' 1	17 FEB 2004	18	
	LYAKOUBI Oussama			1.80 / 5' 1	23 APR 2005	17	
	MAGO Elias			1.80 / 5' 1	23 MAR 2004	18	
	MAURER Aiman			1.80 / 5' 1	25 SEP 2004	17	
	RAIHANI Abdellah			1.80 / 5' 1	3 FEB 2004	18	
	SADIK Omar			1.80 / 5' 1	22 MAR 2004	18	
	TAMOUNE Anouar Khalid			1.80 / 5' 1	18 JUN 2004	18	
	<b>Team averages</b>			1.80 / 5' 1		17.4	

Coach	BAHA Nabil
Coach	BAGUI Abdelilah
Coach	DELHOMEL Gregory Georges
Coach	OUAHBI Mohamed

#### LEGEND

DF	Defender	FW	Forward	GK	Goalkeeper	MF	Midfielder
No.	Shirt Number	Pos	Position				



## Team Roster

As of SAT 25 JUN 2022 at 23:21

### POR - Portugal

No.	Name	Shirt Name	Pos	Height m/f	Date of Birth	Age	Club
	PARREIRA PARENTE Tiago			1.80 / 5 ' 1	14 JAN 2004	18	
1	CARAPINHA CARVALHO Joao Goncalo		GK	1.90 / 6 ' 3	9 APR 2004	18	SC Braga, Braga (POR)
3	DA SILVA OLIVEIRA Hugo		DF	1.75 / 5 ' 9	26 AUG 2004	17	FC Famalicão, Famalicão (POR)
4	DA COSTA BRAS Gabriel		DF	1.85 / 6 ' 1	25 MAR 2004	18	FC Porto, Porto (POR)
5	OLIVEIRA MONTEIRO David Alexandre		DF	1.70 / 5 ' 7	13 MAR 2004	18	Sporting CP, Lisboa (POR)
6	VILELA GAMA Joao Dinis		MF	1.85 / 6 ' 1	16 JAN 2004	18	SC Braga, Braga (POR)
7	NOBREGA MARQUES Ricardo Miguel		FW	1.80 / 5 ' 1	13 MAR 2004	18	SL Benfica, Lisboa (POR)
8	FELIX SEQUEIRA Hugo		MF	1.65 / 5 ' 5	3 MAR 2004	18	SL Benfica, Lisboa (POR)
9	BUCANCIL NABIAN Herculano		FW	1.90 / 6 ' 3	25 JAN 2004	18	Vitória SC, Guimarães (POR)
10	SOUSA CRUZ Marco		MF	1.85 / 6 ' 1	23 FEB 2004	18	Sporting CP, Lisboa (POR)
11	MONTEIRO MEIRELES Jorge		FW	1.70 / 5 ' 7	4 APR 2004	18	FC Porto, Porto (POR)
12	AZEVEDO RIBEIRO Goncalo Miguel		GK	1.90 / 6 ' 3	15 JAN 2006	16	FC Porto, Porto (POR)
13	PINHEIRO MONTEIRO Diogo		DF	1.85 / 6 ' 1	28 JAN 2005	17	Servette FC, Geneve (SUI)
14	ALMEIDA MACEDO Jose Pedro		DF	1.80 / 5 ' 1	5 APR 2004	18	FC Porto, Porto (POR)
15	ALVES DE FREITAS Gustavo Filipe		MF	1.75 / 5 ' 9	11 NOV 2004	17	FC Famalicão, Famalicão (POR)
16	AGUIAR GOMES Bernardo Martim		MF	1.75 / 5 ' 9	14 APR 2004	18	CS Marítimo, Funchal (POR)
17	RODRIGUES CARVALHO Lucas		FW	1.75 / 5 ' 9	7 JUL 2004	17	Sporting CP, Lisboa (POR)
18	MARIANO FALE Miguel Maria		FW	1.75 / 5 ' 9	28 JAN 2004	18	SC Braga, Braga (POR)
				<b>Team averages</b>	1.79 / 5 ' 1	17.7	

Coach DA COSTA MILHEIRO Joaquim Alberto  
 Coach DELGADO PEIXE Emilio Manuel  
 Coach LOUREIRO DE SOUSA Silvino Pedro

#### LEGEND

DF Defender      FW Forward      GK Goalkeeper      MF Midfielder  
 No. Shirt Number      Pos Position



## Team Roster

As of SAT 25 JUN 2022 at 23:21

### TUR - Turkey

No.	Name	Shirt Name	Pos	Height m/f	Date of Birth	Age	Club
	BICER Habib				2 FEB 2004	18	
	BUYUKSAYAR Mehmet Ali				8 MAY 2004	18	
	GUNDUZ Teoman						
	KABASAKAL Ulusoy Mert				2 MAY 2004	18	
	KARADEMIR Ahmet				2 APR 2004	18	
	KAVAS Yasar				15 JAN 2004	18	
	KEFELI Yunus Emre				7 MAY 2004	18	
	KILIC Ali				11 MAR 2004	18	
	MEHMET ENES Gulalan				6 FEB 2004	18	
	ORTAKAYA Emir				22 JUN 2004	18	
	PINARCI Muhammed Mustafa				1 JUN 2004	18	
	SATILMIS Sami				16 MAY 2004	18	
	SENYURT Devran						
	SERHAT Oztasdelen				9 DEC 2004	17	
	TINTIS Emir				12 JAN 2004	18	
	TUNALI Eren				29 APR 2004	18	
	YILMAZ Ali Sahin				1 JAN 2004	18	
	YILMAZ Jankat				16 AUG 2004	17	
<b>Team averages</b>						15.9	

Coach	HACIOGLU Mehmet
Coach	BOLUKBASI Mehmet
Coach	BASOGLU Cihan Mert
Coach	YESILDAG Huseyin

#### LEGEND

DF	Defender	FW	Forward	GK	Goalkeeper	MF	Midfielder
No.	Shirt Number	Pos	Position				



## Pool standings

As of THU 30 JUN 2022 at 22:36

Group A						Matches				Goals				
Rank		FRA	MAR	ALG	ESP	Played	Won	Drawn	Lost	For	Against	Diff.	Fair Pl.	Points
1	<b>FRA</b>	---	1 - 0	3 - 2	1 - 1	3	2	1	0	5	3	2	-5	7
2	<b>MAR</b>	0 - 1	---	2 - 0	1 - 1	3	1	1	1	3	2	1	-11	4
3	<b>ALG</b>	2 - 3	0 - 2	---	1 - 0	3	1	0	2	3	5	-2	-10	3
4	<b>ESP</b>	1 - 1	1 - 1	0 - 1	---	3	0	2	1	2	3	-1	-5	2

Group B						Matches				Goals				
Rank		ITA	TUR	POR	GRE	Played	Won	Drawn	Lost	For	Against	Diff.	Fair Pl.	Points
1	<b>ITA</b>	---	0 - 0	1 - 0	4 - 0	3	2	1	0	5	0	5	-3	7
2	<b>TUR</b>	0 - 0	---	0 - 2	2 - 1	3	1	1	1	2	3	-1	-9	4
3	<b>POR</b>	0 - 1	2 - 0	---	0 - 2	3	1	0	2	2	3	-1	-1	3
4	<b>GRE</b>	0 - 4	1 - 2	2 - 0	---	3	1	0	2	3	6	-3	-4	3

## Games Schedule

Date	Start Time	Phase	Game	Teams	Result
SUN 26 JUN	17:00	Preliminary Group A	1	ESP - ALG	0 - 1
SUN 26 JUN	17:00	Preliminary Group B	4	GRE - TUR	1 - 2
SUN 26 JUN	20:00	Preliminary Group A	2	FRA - MAR	1 - 0
SUN 26 JUN	20:00	Preliminary Group B	3	ITA - POR	1 - 0
TUE 28 JUN	17:00	Preliminary Group A	5	ALG - MAR	0 - 2
TUE 28 JUN	17:00	Preliminary Group B	8	ITA - GRE	4 - 0
TUE 28 JUN	20:00	Preliminary Group A	7	ESP - FRA	1 - 1
TUE 28 JUN	20:00	Preliminary Group B	6	POR - TUR	2 - 0
THU 30 JUN	17:00	Preliminary Group B	9	POR - GRE	0 - 2
THU 30 JUN	17:00	Preliminary Group B	10	TUR - ITA	0 - 0
THU 30 JUN	20:00	Preliminary Group A	11	ALG - FRA	2 - 3
THU 30 JUN	20:00	Preliminary Group A	12	MAR - ESP	1 - 1



## Brackets

As of MON 4 JUL 2022 at 23:28

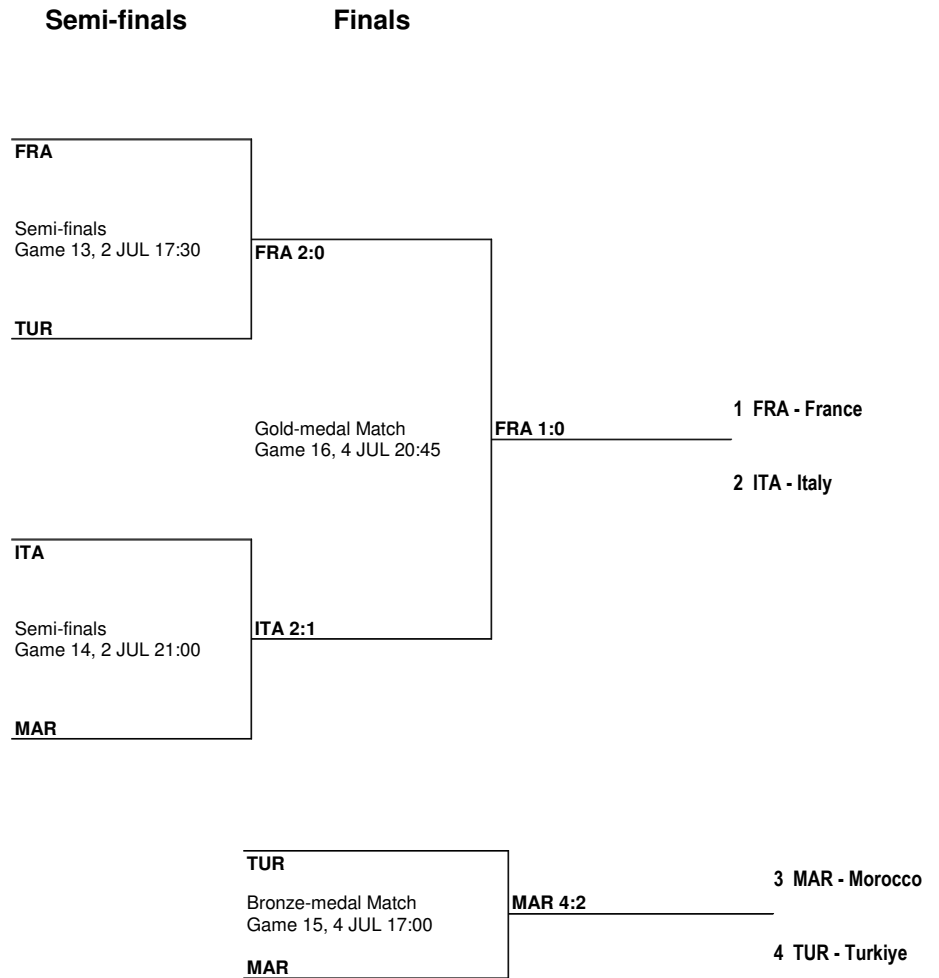





SUN 26 JUN 2022  
Start Time 17:00  
Game Duration: 01:55

## Match Report

### ESP vs ALG

0:1 (0:1)

#### Match Officials:

**Referee:** Evangelos MANOUCHOS (GRE)  
**Assistant Referee 1:** Aurélien DROUET (FRA)  
**Assistant Referee 2:** Mohammed SERRADJ (ALG)  
**4th Official:** RIBEIRO B. (POR)

#### Goal Scored:

PUCH-HERRANTZ 27' Action Goal

#### ESP - Spain

[1] ASTRALAGA ARANGUREN Ander (GK)  
[2] ALEMAN CASTILLO Carlos (C)  
[4] MOSQUERA C.  
[5] CASAS ARCAS Arnau  
[7] BLANCO GOMEZ Fabio (-47')  
[8] MORAN IBANEZ Manuel Angel  
[10] GUERRERO J. (-66')  
[11] EL JEBARI Salim  
[12] RODRIGUEZ A. (-66')  
[14] BASTIDA MOYA Alvaro (-66')  
[16] VALLE GOMEZ Alex

#### Substitutes

[0] FRESNEDA CORRALIZA Ivan  
[6] MARTINEZ R. (+66')  
[9] DENIA DIAZ Marcos (+66')  
[13] FERNANDEZ GONZALEZ Cesar (GK)  
[15] MENDES MENDES Tomas (+66')  
[17] GHARBI ALVAREZ Ismael (+47')  
[18] PUJOL PORTORREAL Edgar Climent

**Coach** AMO AGUADO Pablo

#### Cautions:

MANUEL ANGEL 79' , ZULLIANI 79' , DJADI 90'+8'

#### Expulsions:

#### Additional Time:

1st Half: 2 min., 2nd Half: 6 min.

#### ALG - Algeria

[2] ZAOUI Salah Eddine (-89')  
[3] HANFOUG Fouad (-72')  
[4] BOUNACER Abdessamed  
[5] BOUZAHZAH Ouannis  
[7] ZULLIANI Edhy Yvan (C)  
[8] PUCH-HERRANTZ  
[9] CHEGRA Ivane (-89')  
[10] OMAR Mohamed Rafik (-73')  
[11] DOUGUI Adam (-90'+5')  
[13] AID AI Amin Mohamed  
[16] BOUALAM Hamza

#### Substitutes

[1] BOUMENGOUCHE Abdelaziz C  
[6] LAALLAM Abdelghani (+89')  
[12] DJADI Adam Ghybril (+72')  
[14] NOTTEBAERE Djibril (+73')  
[15] AKHRIB Lahlou  
[17] ABDELKADER M.I. (+90'+5')  
[18] BEN MAZOUZ Mohamed Said (+89')

**Coach** SLATNI Mourad / IKHLEF Kamel / HALEM Ahmed / ACIMI Mohammed Reda



SUN 26 JUN 2022  
Start Time 17:00  
Game Duration: 01:55

**Match Report**  
**ESP vs ALG**  
0:1 (0:1)

**ESP - Spain**

16  
6  
15  
1  
12  
0  
2  
0  
1  
0  
0  
57%  
30

**STATISTICS**

Shots  
Shots on Goal  
Fouls  
Corner Kicks  
Free Kicks  
Penalty Kicks  
Offsides  
Own Goals  
Yellow Cards (Cautions)  
Expulsions (2nd Yellow)  
Red Cards (Expulsions)  
Ball Possession  
Actual Playing Time

**ALG - Algeria**

7  
3  
12  
3  
17  
0  
0  
0  
2  
0  
0  
43%  
23

**ESP - Spain**

No.	Name	Pos	Min	GF	GA	SG/S	PK	Fouls		Y	Red Cards	
								FC	FS		2Y=R	R
1	ASTRALAGA ARANGUREN Ander	GK	98		1							
2	ALEMAN CASTILLO Carlos (C)	DF	98					1				
4	MOSQUERA C.	DF	98					1	1			
5	CASAS ARCAS Arnau	DF	98					3	1			
7	BLANCO GOMEZ Fabio	FW	48			2/2		1	1			
8	MORAN IBANEZ Manuel Angel	MF	98			0/3		2	1	1		
10	GUERRERO LANDABASO Julen Jon	MF	67			1/3		1	1			
11	EL JEBARI Salim	FW	98			0/2		1	1			
12	RODRIGUEZ MUNOZ Alvaro Daniel	FW	67			0/1		1				
14	BASTIDA MOYA Alvaro	MF	67			1/3			1			
16	VALLE GOMEZ Alex	DF	98			1/1		2	2			
<b>Substitutes</b>												
6	MARTINEZ SANTAMARIA Roger	MF	31			1/1		1	1			
9	DENIA DIAZ Marcos	FW	31					1				
15	MENDES MENDES Tomas	MF	31						1			
17	GHARBI ALVAREZ Ismael	MF	50					1				
<b>Totals</b>					1	6/16		15	11	1		

**ALG - Algeria**

No.	Name	Pos	Min	GF	GA	SG/S	PK	Fouls		Y	Red Cards	
								FC	FS		2Y=R	R
2	ZAQUI Salah Eddine		91					2	3			
3	HANFOUG Fouad		73					1				
4	BOUNACER Abdessamed		98					1	3			
5	BOUZAHZAH Ouanisse		98									
7	ZULLIANI Edhy Yvan (C)		98			0/1		2	2	1		
8	PUCH-HERRANTZ		98	1		1/1		1				
9	CHEGRA Ivane		91			2/4						
10	OMAR Mohamed Rafik		75			0/1		2	2			
11	DOUGUI Adam		97						1			
13	AID AI Amin Mohamed		98						3			
16	BOUALAM Hamza		98									
<b>Substitutes</b>												
6	LAALLAM Abdelghani		7									
12	DJADI Adam Ghvbril		25					1		1		
14	NOTTEBAERE Diibril		23					1				
17	ABDELKADER Mohamed Islem		1									
18	BEN MAZOUZ Mohamed Said		7					1				
<b>Totals</b>				1		3/7		12	14	2		



Stade Sig  
Football  
Men  
Preliminary - Group A  
Match 1



SUN 26 JUN 2022  
Start Time 17:00  
Game Duration: 01:55

**Match Report**  
**ESP vs ALG**  
**0:1 (0:1)**

**LEGEND**

<b>(C)</b> Captain	<b>+nn</b> Time when player substituted in	<b>2Y=R</b> 2nd Yellow = Red Card	<b>AET</b> After Extra Time
<b>DF</b> Defender	<b>FC</b> Fouls Committed	<b>FS</b> Fouls Suffered	<b>FW</b> Forward
<b>GA</b> Goals Against	<b>GF</b> Goals for	<b>GK</b> Goalkeeper	<b>MF</b> Midfielder
<b>R</b> Red Cards (Expulsions)	<b>SG/S</b> Shots on Goal/Shots	<b>Y</b> Yellow Card	<b>PSO</b> Penalty Shoot-out



SUN 26 JUN 2022  
Start Time 20:00  
Game Duration: 01:50

**Match Report**  
**FRA vs MAR**  
**1:0 (1:0)**

**Match Officials:**

**Referee:** Luca PAIRETTO (ITA)  
**Assistant Referee 1:** ZERHOUNI A. (ALG)  
**Assistant Referee 2:** Adel ABBANE (ALG)  
**4th Official:** Zorbay KUCUK (TUR)

**Match Delegate:** Beloufa MAZZIZ (ALG)

**Goal Scored:**

MESSOUSSA 15' Penalty Goal

**FRA - France**

[2] LOUIS-JEAN Johaneke Henri  
[4] MERCIER Kevin Mathis  
[6] BUAYI KIALA Nathan (C)  
[7] PIRRINGUEL Lenny Seive (-77')  
[10] BELAHYANE Reda (-64')  
[11] BACHA Mohamed Adel (-64')  
[12] BOLUMBU D. (-77')  
[13] EL HANNACH Y. (-82')  
[15] BOUANANI Badredine  
[16] ZADI Alain Georges  
[17] MESSOUSSA A. (-86')

**Substitutes**

[1] PATOUILLET Mathieu Franck  
[3] KABA Kanfory (+82')  
[5] CHIESA Ange (+77') (-79')  
[8] DOUMBIA Cheick Mohamed (+81')  
[9] KANOUTE Mahamadou (+86')  
[14] BONGEMBA Edvin (+64')  
[18] IKIA DIMI Yvan Junior (+64')

**Coach** ROUXEL Lionel

**Cautions:**

EL HANNACH 5', TAMOUNE 90'+1', AMMAL 90'+3'

**Expulsions:**

**Additional Time:**

1st Half: 0 min., 2nd Half: 4 min.

**MAR - Morocco**

[3] AKHARRAZ Youness (-74')  
[4] AMMAL Abdessamad  
[7] LYAKOUBI Oussama (C) (-70')  
[8] JAZOULI Mohammed Younes  
[10] ARHOUN Usama (-65')  
[11] MAURER Aiman (-65')  
[12] HASBI Walid  
[15] BOUKHRES Othmane  
[16] TAMOUNE Anouar Khalid  
[17] RAIHANI Abdellah  
[18] KHALIFI Yassine

**Substitutes**

[1] MAGO Elias  
[2] LANTAKI Wassim (+70')  
[5] EL HAMMAMI Ayoub (+74')  
[6] BAALLAL Abdellah (+65')  
[9] SADIK Omar  
[13] KHATIR Ahmed  
[14] ANHARI Hamza (+65')

**Coach** BAHA Nabil / BAGUI Abdelilah / DELHOMEL Gregory Georges / OUAHBI Moha



SUN 26 JUN 2022  
Start Time 20:00  
Game Duration: 01:50

**Match Report**  
**FRA vs MAR**  
**1:0 (1:0)**

**FRA - France**

8  
6  
19  
6  
13  
1  
1  
0  
1  
0  
0  
0  
47%  
27

**STATISTICS**

Shots  
Shots on Goal  
Fouls  
Corner Kicks  
Free Kicks  
Penalty Kicks  
Offsides  
Own Goals  
Yellow Cards (Cautions)  
Expulsions (2nd Yellow)  
Red Cards (Expulsions)  
Ball Possession  
Actual Playing Time

**MAR - Morocco**

11  
3  
11  
4  
20  
0  
2  
0  
2  
0  
0  
53%  
31

**FRA - France**

No.	Name	Pos	Min	GF	GA	SG/S	PK	Fouls		Y	Red Cards	
								FC	FS		2Y=R	R
2	LOUIS-JEAN Johaneke Henri		94					1	1			
4	MERCIER Kevin Mathis		94					1	1			
6	BUAYI KIALA Nathan (C)		94					1				
7	PIRRINGUEL Lenny Seive		77			1/1		3				
10	BELAHYANE Reda		63					2	2			
11	BACHA Mohamed Adel		63			1/2		1				
12	BOLUMBU D.		78					1	1			
13	EL HANNACH Younes Mohamed		81					2		1		
15	BOUANANI Badredine		94			2/2		2	3			
16	ZADI Alain Georges		94									
17	MESSOUSSA Amine Abdelrahmane		85	1		2/3	1/1	3				
<b>Substitutes</b>												
3	KABA Kanfory		13									
5	CHIESA Ange		3									
8	DOUMBIA Cheick Mohamed		14									
9	KANOUTE Mahamadou		8									
14	BONGEMBA Edvin		31						2			
18	IKIA DIMI Yvan Junior		31					1	1			
<b>Totals</b>				1		6/8	1/1	19	11	1		

**MAR - Morocco**

No.	Name	Pos	Min	GF	GA	SG/S	PK	Fouls		Y	Red Cards	
								FC	FS		2Y=R	R
3	AKHARRAZ Youness		73									
4	AMMAL Abdessamad		94			0/1		1	3	1		
7	LYAKOUBI Oussama (C)		70			0/4		1	1			
8	JAZOULI Mohammed Younes		94			1/1		1	3			
10	ARHOUN Usama		65			0/2			1			
11	MAURER Aiman		65					2	5			
12	HASBI Walid		94		1							
15	BOUKHRES Othmane		94									
16	TAMOUNE Anouar Khalid		94							1		
17	RAIHANI Abdellah		94			1/1		1				
18	KHALIFI Yassine		94			1/2		2	3			
<b>Substitutes</b>												
2	LANTAKI Wassim		24									
5	EL HAMMAMI Ayoub		21					1				
6	BAALLAL Abdellah		29					1	1			
14	ANHARI Hamza		29					1	2			
<b>Totals</b>					1	3/11		11	19	2		



Stade Sig  
Football  
Men  
Preliminary - Group A  
Match 2



SUN 26 JUN 2022  
Start Time 20:00  
Game Duration: 01:50

**Match Report**  
**FRA vs MAR**  
1:0 (1:0)

**LEGEND**

<b>(C)</b> Captain	<b>+nn</b> Time when player substituted in	<b>2Y=R</b> 2nd Yellow = Red Card	<b>AET</b> After Extra Time
<b>DF</b> Defender	<b>FC</b> Fouls Committed	<b>FS</b> Fouls Suffered	<b>FW</b> Forward
<b>GA</b> Goals Against	<b>GF</b> Goals for	<b>GK</b> Goalkeeper	<b>MF</b> Midfielder
<b>R</b> Red Cards (Expulsions)	<b>SG/S</b> Shots on Goal/Shots	<b>Y</b> Yellow Card	<b>PSO</b> Penalty Shoot-out



TUE 28 JUN 2022  
Start Time 17:00  
Game Duration: 01:10

**Match Report**  
**ALG vs MAR**  
**0:2 (0:0)**

**Match Officials:**

**Referee:** Amir LOUCIF (TUN)  
**Assistant Referee 1:** Mohamed BAKIR (TUN)  
**Assistant Referee 2:** Wael HANNACHI (TUN)  
**4th Official:** Luca PAIRETTO (ITA)

**Goal Scored:**

BOUKHRES 48' Head Goal , RAIHANI 64' Fastbreak Goal

**ALG - Algeria**

[2] ZAOUI Salah Eddine  
[3] HANFOUG Fouad  
[4] BOUNACER Abdessamed  
[5] BOUZAHZAH Ouanisse (-78')  
[7] ZULLIANI Edhy Yvan (C) (-79')  
[8] PUCH-HERRANTZ  
[10] OMAR Mohamed Rafik  
[11] DOUGUI Adam (-65')  
[13] AID Al Amin Mohamed (-65')  
[16] BOUALAM Hamza  
[18] BEN MAZOUZ Mohamed Said (-79')

**Substitutes**

[1] BOUMENGOUCHE Abdelaziz C  
[6] LAALLAM Abdelghani  
[9] CHEGRA Ivane (+65')  
[12] DJADI Adam Ghybril (+78')  
[14] NOTTEBAERE Djibril (+65')  
[15] AKHRIB Lahlou (+79')  
[17] ABDELKADER M.I. (+79')

**Coach** SLATNI Mourad / IKHLEF Kamel / HALEM Ahmed / ACIMI Mohammed Reda

**MAR - Morocco**

[1] MAGO Elias  
[2] LANTAKI Wassim (-90'+2')  
[4] AMMAL Abdessamad  
[5] EL HAMMAMI Ayoub (-60')  
[8] JAZOULI Mohammed Younes  
[10] ARHOUN Usama  
[11] MAURER Aiman (-74')  
[14] ANHARI Hamza  
[15] BOUKHRES Othmane (C)  
[17] RAIHANI Abdellah (-75')  
[18] KHALIFI Yassine (-75')

**Substitutes**

[3] AKHARRAZ Youness (+75')  
[6] BAALLAL Abdellah  
[7] LYAKOUBI Oussama (+75')  
[9] SADIK Omar (+74')  
[12] HASBI Walid  
[13] KHATIR Ahmed (+60')  
[16] TAMOUNE A. (+90'+2')

**Coach** BAHA Nabil / BAGUI Abdellah / DELHOMEL Gregory Georges / OUAHBI Moha

**Cautions:**

BOUNACER 26' , AMMAL 26' , ARHOUN 44' , MAGO 53' , HANFOUG 61' , RAIHANI 62' , AKHARRAZ 87' , LYAKOUBI 90'+2' , AKHRIB 90'+2' , TAMOUNE 90'+7'

**Expulsions:**

HANFOUG 45' 2nd Yellow Card

**Additional Time:**

1st Half: 2 min., 2nd Half: 6 min.



Stade Sig

Football

Men

Preliminary - Group A

Match 5



TUE 28 JUN 2022  
Start Time 17:00  
Game Duration: 01:10

## Match Report ALG vs MAR 0:2 (0:0)

### ALG - Algeria

11  
6  
14  
4  
29  
0  
1  
0  
3  
1  
0  
53%  
24

### STATISTICS

Shots  
Shots on Goal  
Fouls  
Corner Kicks  
Free Kicks  
Penalty Kicks  
Offsides  
Own Goals  
Yellow Cards (Cautions)  
Expulsions (2nd Yellow)  
Red Cards (Expulsions)  
Ball Possession  
Actual Playing Time

### MAR - Morocco

13  
6  
26  
2  
15  
0  
3  
0  
7  
0  
0  
47%  
21

### ALG - Algeria

No.	Name	Pos	Min	GF	GA	SG/S	PK	Fouls		Y	Red Cards	
								FC	FS		2Y=R	R
2	ZAOUI Salah Eddine		98					1	3			
3	HANFOUG Fouad		45					1	2	1	1	
4	BOUNACER Abdessamed		98			1/1		1	2	1		
5	BOUZAHZAH Ouanisse		80					1				
7	ZULLIANI Edhy Yvan (C)		81			1/2		3	1			
8	PUCH-HERRANTZ		98			0/1		2	8			
10	OMAR Mohamed Rafik		98			1/2			4			
11	DOUGUI Adam		66			0/1		1	1			
13	AID Al Amin Mohamed		66					1	3			
16	BOUALAM Hamza		98		2							
18	BEN MAZOUZ Mohamed Said		80			2/2		2				
<b>Substitutes</b>												
9	CHEGRA Ivane		32					1	2			
12	DJADI Adam Ghybril		18									
14	NOTTEBAERE Djibril		32			0/1						
15	AKHRIB Lahlou		17			1/1				1		
17	ABDELKADER Mohamed Islem		17									
<b>Totals</b>					2	6/11		14	26	3	1	

### MAR - Morocco

No.	Name	Pos	Min	GF	GA	SG/S	PK	Fouls		Y	Red Cards	
								FC	FS		2Y=R	R
1	MAGO Elias		98						1			
2	LANTAKI Wassim		93					1	1			
4	AMMAL Abdessamad		98					1	1	1		
5	EL HAMMAMI Ayoub		61			0/1		3	1			
8	JAZOULI Mohammed Younes		98			0/1		5	1			
10	ARHOUN Usama		98					2	1	1		
11	MAURER Aiman		76			2/4		4	1			
14	ANHARI Hamza		98					2	2			
15	BOUKHRES Othmane (C)		98	1		1/1		1				
17	RAIHANI Abdellah		77	1		1/1		2	2	1		
18	KHALIFI Yassine		76			1/3		1				
<b>Substitutes</b>												
3	AKHARRAZ Youness		21					1		1		
7	LYAKOUBI Oussama		21							1		
9	SADIK Omar		22			1/2		3				
13	KHATIR Ahmed		37									
16	TAMOUNE Anouar Khalid		5							1		
<b>Totals</b>				2		6/13		26	13	7		





Stade Sig  
Football  
Men  
Preliminary - Group A  
Match 5



TUE 28 JUN 2022  
Start Time 17:00  
Game Duration: 01:10

**Match Report**  
**ALG vs MAR**  
**0:2 (0:0)**

**LEGEND**

<b>(C)</b> Captain	<b>+nn</b> Time when player substituted in	<b>2Y=R</b> 2nd Yellow = Red Card	<b>AET</b> After Extra Time
<b>DF</b> Defender	<b>FC</b> Fouls Committed	<b>FS</b> Fouls Suffered	<b>FW</b> Forward
<b>GA</b> Goals Against	<b>GF</b> Goals for	<b>GK</b> Goalkeeper	<b>MF</b> Midfielder
<b>R</b> Red Cards (Expulsions)	<b>SG/S</b> Shots on Goal/Shots	<b>Y</b> Yellow Card	<b>PSO</b> Penalty Shoot-out



Stade Ahmed Zabana

Football

Men

Preliminary - Group A

Match 7



TUE 28 JUN 2022

Start Time 20:00

Game Duration: 02:02

## Match Report ESP vs FRA

1:1 (0:0)

### Match Officials:

**Referee:** Zorbay KUCUK (TUR)  
**Assistant Referee 1:** Beloufa MAZZIZ (ALG)  
**Assistant Referee 2:** Brahim HAMLAOUI (ALG)  
**4th Official:** RIBEIRO B. (POR)

### Goal Scored:

ALEX VALLE 47' Action Goal, IKIA DIMI 55' Action Goal

### ESP - Spain

[1] ASTRALAGA ARANGUREN Ander (GK)  
[2] ALEMAN CASTILLO Carlos (C)  
[4] MOSQUERA C.  
[6] MARTINEZ R. (-84')  
[7] BLANCO GOMEZ Fabio  
[8] MORAN IBANEZ Manuel Angel  
[9] DENIA DIAZ Marcos  
[15] MENDES MENDES Tomas (-67')  
[16] VALLE GOMEZ Alex  
[17] GHARBI ALVAREZ Ismael (-82')  
[18] PUJOL E. (-83')

#### Substitutes

[3] FRESNEDA CORRALIZA Ivan  
[5] CASAS ARCAS Arnau  
[10] GUERRERO J. (+82')  
[11] EL JEBARI Salim (+67')  
[12] RODRIGUEZ A. (+83')  
[13] FERNANDEZ GONZALEZ Cesar (GK)  
[14] BASTIDA MOYA Alvaro (+84')

**Coach** AMO AGUADO Pablo

### Cautions:

EDGAR 14' , MESSOUSSA 64' , PATOUILLET 76' , ROGER 77'

### Expulsions:

### Additional Time:

1st Half: 3 min., 2nd Half: 5 min.

### FRA - France

[1] PATOUILLET Mathieu Franck  
[2] LOUIS-JEAN Johaneke Henri  
[3] KABA Kanfory  
[5] CHIESA Ange (-83')  
[6] BUAYI KIALA Nathan (C)  
[8] DOUMBIA Cheick Mohamed (-72')  
[9] KANOUTE Mahamadou (-59')  
[11] BACHA Mohamed Adel (-59')  
[13] EL HANNACH Younes Mohamed  
[14] BONGEMBA Edvin  
[18] IKIA DIMI Yvan Junior (-72')

#### Substitutes

[4] MERCIER Kevin Mathis (+83')  
[10] BELAHYANE Reda (+72')  
[12] BOLUMBU D. (+72')  
[15] BOUANANI Badredine (+59')  
[16] ZADI Alain Georges  
[17] MESSOUSSA A. (+59')

**Coach** ROUXEL Lionel



Stade Ahmed Zabana

Football

Men

Preliminary - Group A

Match 7



TUE 28 JUN 2022

Start Time 20:00

Game Duration: 02:02

## Match Report ESP vs FRA

1:1 (0:0)

### ESP - Spain

25  
11  
15  
8  
13  
0  
3  
0  
2  
0  
0  
70%  
37

### STATISTICS

Shots  
Shots on Goal  
Fouls  
Corner Kicks  
Free Kicks  
Penalty Kicks  
Offsides  
Own Goals  
Yellow Cards (Cautions)  
Expulsions (2nd Yellow)  
Red Cards (Expulsions)  
Ball Possession  
Actual Playing Time

### FRA - France

8  
4  
13  
4  
18  
0  
0  
0  
2  
0  
0  
30%  
16

### ESP - Spain

No.	Name	Pos	Min	GF	GA	SG/S	PK	Fouls		Y	Red Cards	
								FC	FS		2Y=R	R
1	ASTRALAGA ARANGUREN Ander	GK	98		1							
2	ALEMAN CASTILLO Carlos (C)	DF	98			1/1		2				
4	MOSQUERA C.	DF	98						1			
6	MARTINEZ SANTAMARIA Roger	MF	86			1/2		2	4	1		
7	BLANCO GOMEZ Fabio	FW	98			2/4		2	1			
8	MORAN IBANEZ Manuel Angel	MF	98			1/3		1	2			
9	DENIA DIAZ Marcos	FW	98			2/3		2				
15	MENDES MENDES Tomas	MF	70									
16	VALLE GOMEZ Alex	DF	98	1		2/2		1	1			
17	GHARBI ALVAREZ Ismael	MF	85			2/4		4	4			
18	PUJOL PORTORREAL Edgar Climent	DF	85			0/1				1		
<b>Substitutes</b>												
10	GUERRERO LANDABASO Julen Jon	MF	13			0/2						
11	EL JEBARI Salim	FW	28			0/2						
12	RODRIGUEZ MUNOZ Alvaro Daniel	FW	13			0/1		1				
14	BASTIDA MOYA Alvaro	MF	12									
<b>Totals</b>				1	1	11/25		15	13	2		

### FRA - France

No.	Name	Pos	Min	GF	GA	SG/S	PK	Fouls		Y	Red Cards	
								FC	FS		2Y=R	R
1	PATOUILLET Mathieu Franck		98		1					1		
2	LOUIS-JEAN Johaneke Henri		98			0/1		2	2			
3	KABA Kanfory		98					1	2			
5	CHIESA Ange		86			0/1		1	1			
6	BUAYI KIALA Nathan (C)		98					1	2			
8	DOUMBIA Cheick Mohamed		75			0/1			2			
9	KANOUTE Mahamadou		61					1				
11	BACHA Mohamed Adel		61			0/1		1	1			
13	EL HANNACH Younes Mohamed		98									
14	BONGEMBA Edvin		98					3	4			
18	IKIA DIMI Yvan Junior		75	1		2/2		1				
<b>Substitutes</b>												
4	MERCIER Kevin Mathis		12									
10	BELAHYANE Reda		23					1				
12	BOLUMBU D.		23									
15	BOUANANI Badredine		37			2/2						
17	MESSOUSSA Amine Abdelrahmane		37					1		1		
<b>Totals</b>				1	1	4/8		13	14	2		



Stade Ahmed Zabana

Football

Men

Preliminary - Group A

Match 7



TUE 28 JUN 2022

Start Time 20:00

Game Duration: 02:02

## Match Report ESP vs FRA

1:1 (0:0)

### LEGEND

<b>(C)</b> Captain	<b>+nn</b> Time when player substituted in	<b>2Y=R</b> 2nd Yellow = Red Card	<b>AET</b> After Extra Time
<b>DF</b> Defender	<b>FC</b> Fouls Committed	<b>FS</b> Fouls Suffered	<b>FW</b> Forward
<b>GA</b> Goals Against	<b>GF</b> Goals for	<b>GK</b> Goalkeeper	<b>MF</b> Midfielder
<b>R</b> Red Cards (Expulsions)	<b>SG/S</b> Shots on Goal/Shots	<b>Y</b> Yellow Card	<b>PSO</b> Penalty Shoot-out



THU 30 JUN 2022  
Start Time 20:00  
Game Duration: 01:57

## Match Report

### ALG vs FRA

2:3 (0:2)

#### Match Officials:

**Referee:** Luca PAIRETTO (ITA)  
**Assistant Referee 1:** Wael HANNACHI (TUN)  
**Assistant Referee 2:** Evangelos MANOUCHOS (GRE)  
**4th Official:** Mohamed BAKIR (TUN)

#### Goal Scored:

MESSOUSSA 8' Action Goal, MESSOUSSA 28' Action Goal, CHEGRA 56' Penalty Goal, ZAOUI 79' Head Goal, BOUANANI 81' Penalty Goal

#### ALG - Algeria

[1] BOUMENGOUCHE Abdelaziz C  
[2] ZAOUI Salah Eddine  
[4] BOUNACER Abdessamed  
[6] LAALLAM Abdelghani  
[8] PUCH-HERRANTZ  
[9] CHEGRA Ivane  
[11] DOUGUI Adam (-62')  
[12] DJADI Adam Ghybril  
[14] NOTTEBAERE Djibril (-46')  
[17] ABDELKADER M.I. (-87')  
[18] BEN MAZOUZ Mohamed Said

#### Substitutes

[3] HANFOUG Fouad  
[5] BOUZAHZAH Ouanisse  
[7] ZULLIANI Edhy Yvan (+62')  
[10] OMAR Mohamed Rafik (+46')  
[13] AID Al Amin Mohamed (+87')  
[15] AKHRIB Lahlou  
[16] BOUALAM Hamza

**Coach** SLATNI Mourad / IKHLEF Kamel / HALEM Ahmed / ACIMI Mohammed Reda

#### Cautions:

BOUANANI, BOUNACER, ZAOUI, PIRRINGUEL 67', OMAR 87'

#### Expulsions:

#### Additional Time:

1st Half: 0 min., 2nd Half: 4 min.

#### FRA - France

[2] LOUIS-JEAN J. (-64')  
[4] MERCIER Kevin Mathis  
[7] PIRRINGUEL Lenny Seive (-76')  
[10] BELAHYANE Reda (-64')  
[12] BOLUMBU D.  
[13] EL HANNACH Younes Mohamed  
[14] BONGEMBA Edvin  
[15] BOUANANI Badredine  
[16] ZADI Alain Georges (GK)  
[17] MESSOUSSA A. (-83')  
[18] IKIA DIMI Yvan Junior (-46')

#### Substitutes

[1] PATOUILLET Mathieu Franck (GK)  
[3] KABA Kanfory (+83')  
[5] CHIESA Ange (+64')  
[6] BUAYI KIALA Nathan (+64')  
[8] DOUMBIA Cheick Mohamed (+46')  
[9] KANOUTE Mahamadou  
[11] BACAHA Mohamed Adel (+76')

**Coach** ROUXEL Lionel



THU 30 JUN 2022  
 Start Time 20:00  
 Game Duration: 01:57

## Match Report ALG vs FRA 2:3 (0:2)

### ALG - Algeria

14  
 5  
 7  
 6  
 16  
 1  
 0  
 0  
 3  
 0  
 0  
 48%  
 30

### STATISTICS

Shots  
 Shots on Goal  
 Fouls  
 Corner Kicks  
 Free Kicks  
 Penalty Kicks  
 Offsides  
 Own Goals  
 Yellow Cards (Cautions)  
 Expulsions (2nd Yellow)  
 Red Cards (Expulsions)  
 Ball Possession  
 Actual Playing Time

### FRA - France

12  
 7  
 14  
 4  
 7  
 1  
 2  
 0  
 0  
 0  
 52%  
 33

### ALG - Algeria

No.	Name	Pos	Min	GF	GA	SG/S	PK	Fouls		Y	Red Cards	
								FC	FS		2Y=R	R
1	BOUMENGOUCHE Abdelaziz C		94		3							
2	ZAQUI Salah Eddine		94	1		1/1		1		1		
4	BOUNACER Abdessamed		94			0/1		1	4	1		
6	LAALLAM Abdelghani		94									
8	PUCH-HERRANTZ		94			0/2		2	2			
9	CHEGRA Ivane		94	1		1/4	1/1	2	2			
11	DOUGUI Adam		61			1/1			1			
12	DJADI Adam Ghybril		94									
14	NOTTEBAERE Djibril		45									
17	ABDELKADER Mohamed Islem		87					1	1			
18	BEN MAZOUZ Mohamed Said		94			0/2			3			
<b>Substitutes</b>												
7	ZULLIANI Edhy Yvan		33						1			
10	OMAR Mohamed Rafik		49			2/3				1		
13	AID Al Amin Mohamed		7									
<b>Totals</b>				2	3	5/14	1/1	7	14	3		

### FRA - France

No.	Name	Pos	Min	GF	GA	SG/S	PK	Fouls		Y	Red Cards	
								FC	FS		2Y=R	R
2	LOUIS-JEAN Johaneke Henri	DF	63									
4	MERCIER Kevin Mathis	DF	94					1	2			
7	PIRRINGUEL Lenny Seive	MF	76					2	1	1		
10	BELAHYANE Reda	MF	63					2				
12	BOLUMBU D.	DF	94									
13	EL HANNACH Younes Mohamed	DF	94					1				
14	BONGEMBA Edvin	MF	94					1				
15	BOUANANI Badredine	FW	94	1		3/5	1/1		1	1		
16	ZADI Alain Georges	GK	94		2				1			
17	MESSOUSSA Amine Abdelrahmane	FW	82	2		3/4		4	1			
18	IKIA DIMI Yvan Junior	FW	45			1/1		1	1			
<b>Substitutes</b>												
3	KABA Kanfory	DF	12									
5	CHIESA Ange	DF	31					1				
6	BUAYI KIALA Nathan	MF	31									
8	DOUMBIA Cheick Mohamed	MF	49			0/2						
11	BACAHA Mohamed Adel	FW	18					1				
<b>Totals</b>				3	2	7/12	1/1	14	7	2		



Stade Ahmed Zabana

Football

Men

Preliminary - Group A

Match 11



THU 30 JUN 2022  
Start Time 20:00  
Game Duration: 01:57

**Match Report**  
**ALG vs FRA**  
**2:3 (0:2)**

**LEGEND**

<b>(C)</b> Captain	<b>+nn</b> Time when player substituted in	<b>2Y=R</b> 2nd Yellow = Red Card	<b>AET</b> After Extra Time
<b>DF</b> Defender	<b>FC</b> Fouls Committed	<b>FS</b> Fouls Suffered	<b>FW</b> Forward
<b>GA</b> Goals Against	<b>GF</b> Goals for	<b>GK</b> Goalkeeper	<b>MF</b> Midfielder
<b>R</b> Red Cards (Expulsions)	<b>SG/S</b> Shots on Goal/Shots	<b>Y</b> Yellow Card	<b>PSO</b> Penalty Shoot-out



THU 30 JUN 2022  
Start Time 20:00  
Game Duration: 00:49

**Match Report**  
**MAR vs ESP**  
**1:1 (1:1)**

**Match Officials:**

**Referee:** RIBEIRO B. (POR)  
**Assistant Referee 1:** Aurélien DROUET (FRA)  
**Assistant Referee 2:** Mohammed SERRADJ (ALG)  
**4th Official:** Jérémie PIGNARD (FRA)

**Goal Scored:**

ALVARO 12' Head Goal , KHALIFI 23' Penalty Goal

**MAR - Morocco**

[1] MAGO Elias  
[2] LANTAKI Wassim (-84')  
[5] EL HAMMAMI Ayoub  
[8] JAZOULI Mohammed Younes  
[9] SADIK Omar (-85')  
[10] ARHOUN Usama (-71')  
[11] MAURER Aiman (-71')  
[13] KHATIR Ahmed  
[14] ANHARI Hamza  
[15] BOUKHRES Othmane (C)  
[18] KHALIFI Yassine

**Substitutes**

[3] AKHARRAZ Youness (+71')  
[6] BAALLAL Abdellah  
[7] LYAKOUBI Oussama (+71')  
[12] HASBI Walid  
[16] TAMOUNE Anouar Khalid (+84')  
[17] RAIHANI Abdellah (+85')

**Coach** BAHA Nabil / BAGUI Abdellah / DELHOMEL Gregory Georges / OUAHBI Moha

**Cautions:**

BASTIDA 56' , ARHOUN 66' , MAURER 68' , ROGER 90'+5'

**Expulsions:**

**Additional Time:**

1st Half: 1 min., 2nd Half: 4 min.

**ESP - Spain**

[2] ALEMAN CASTILLO Carlos (C)  
[4] MOSQUERA C. (-69')  
[7] BLANCO GOMEZ Fabio (-68')  
[9] DENIA DIAZ Marcos  
[11] EL JEBARI Salim (-59')  
[12] RODRIGUEZ MUNOZ Alvaro Daniel  
[13] FERNANDEZ GONZALEZ Cesar (GK)  
[14] BASTIDA MOYA Alvaro (-58')  
[15] MENDES MENDES Tomas  
[16] VALLE GOMEZ Alex (-82')  
[18] PUJOL PORTORREAL Edgar Climent

**Substitutes**

[1] ASTRALAGA ARANGUREN Ander (GK)  
[3] FRESNEDA CORRALIZA Ivan (+69')  
[5] CASAS ARCAS Arnau  
[6] MARTINEZ R. (+82')  
[8] MORAN M. (+59')  
[10] GUERRERO J. (+68')  
[17] GHARBI ALVAREZ Ismael (+58')

**Coach** AMO AGUADO Pablo





THU 30 JUN 2022  
Start Time 20:00  
Game Duration: 00:49

## Match Report MAR vs ESP 1:1 (1:1)

### MAR - Morocco

3  
2  
10  
0  
8  
1  
1  
0  
2  
0  
0  
0  
36%  
18

### STATISTICS

Shots  
Shots on Goal  
Fouls  
Corner Kicks  
Free Kicks  
Penalty Kicks  
Offsides  
Own Goals  
Yellow Cards (Cautions)  
Expulsions (2nd Yellow)  
Red Cards (Expulsions)  
Ball Possession  
Actual Playing Time

### ESP - Spain

2  
1  
5  
2  
11  
0  
3  
0  
2  
0  
0  
64%  
32

### MAR - Morocco

No.	Name	Pos	Min	GF	GA	SG/S	PK	Fouls		Y	Red Cards	
								FC	FS		2Y=R	R
1	MAGO Elias		95		1							
2	LANTAKI Wassim		85					1				
5	EL HAMMAMI Ayoub		95						1			
8	JAZOULI Mohammed Younes		95					1				
9	SADIK Omar		85			1/2		2				
10	ARHOUN Usama		72					1		1		
11	MAURER Aiman		72					1	1	1		
13	KHATIR Ahmed		95									
14	ANHARI Hamza		95					2				
15	BOUKHRES Othmane (C)		95									
18	KHALIFI Yassine		95	1		1/1	1/1	2	3			
<b>Substitutes</b>												
3	AKHARRAZ Youness		23									
7	LYAKOUBI Oussama		23									
16	TAMOUNE Anouar Khalid		10									
17	RAIHANI Abdellah		10									
<b>Totals</b>				1	1	2/3	1/1	10	5	2		

### ESP - Spain

No.	Name	Pos	Min	GF	GA	SG/S	PK	Fouls		Y	Red Cards	
								FC	FS		2Y=R	R
2	ALEMAN CASTILLO Carlos (C)	DF	95									
4	MOSQUERA C.	DF	70					2				
7	BLANCO GOMEZ Fabio	FW	69						2			
9	DENIA DIAZ Marcos	FW	95					1				
11	EL JEBARI Salim	FW	59						1			
12	RODRIGUEZ MUNOZ Alvaro Daniel	FW	95	1		1/2						
13	FERNANDEZ GONZALEZ Cesar	GK	95		1				1			
14	BASTIDA MOYA Alvaro	MF	59					1		1		
15	MENDES MENDES Tomas	MF	95						1			
16	VALLE GOMEZ Alex	DF	82					1	2			
18	PUJOL PORTORREAL Edgar Climent	DF	95									
<b>Substitutes</b>												
3	FRESNEDA CORRALIZA Ivan	DF	25									
6	MARTINEZ SANTAMARIA Roger	MF	13							1		
8	MORAN IBANEZ Manuel Angel	MF	36						1			
10	GUERRERO LANDABASO Julen Jon	MF	26						1			
17	GHARBI ALVAREZ Ismael	MF	36						1			
<b>Totals</b>				1	1	1/2		5	10	2		



Stade Sig  
Football  
Men  
Preliminary - Group A  
Match 12



THU 30 JUN 2022  
Start Time 20:00  
Game Duration: 00:49

**Match Report**  
**MAR vs ESP**  
1:1 (1:1)

**LEGEND**

<b>(C)</b> Captain	<b>+nn</b> Time when player substituted in	<b>2Y=R</b> 2nd Yellow = Red Card	<b>AET</b> After Extra Time
<b>DF</b> Defender	<b>FC</b> Fouls Committed	<b>FS</b> Fouls Suffered	<b>FW</b> Forward
<b>GA</b> Goals Against	<b>GF</b> Goals for	<b>GK</b> Goalkeeper	<b>MF</b> Midfielder
<b>R</b> Red Cards (Expulsions)	<b>SG/S</b> Shots on Goal/Shots	<b>Y</b> Yellow Card	<b>PSO</b> Penalty Shoot-out



SUN 26 JUN 2022

Start Time 20:00

## Match Report ITA vs POR

1:0

### Match Officials:

Referee: Karim SABRY (MAR)

4th Official: Youcef GAMOUH (ALG)

### Goal Scored:

RAIMONDO Action Goal

### ITA - Italy

- [1] MASTRANTONIO Davide (GK)
- [2] MISSORI Filippo (C)
- [3] REGONESI Iacopo
- [5] DELLAVALLE Lorenzo
- [7] HASA Luis
- [8] KUMI Justin
- [9] MANCINI Tommaso
- [10] ACCORNERO Federico
- [14] GUARINO Gabriele
- [15] AMATUCCI Lorenzo
- [16] IGNACCHITI Lorenzo

#### Substitutes

- [4] PALELLA Andrea
- [6] INDRAGOLI Gabriele
- [11] PATANE' Nicola
- [12] BAGNOLINI Nicola
- [13] BOZZOLAN Andrea
- [17] D'ANDREA Luca
- [18] RAIMONDO Antonio

**Coach** VARESCO Nicolo / BARELLA Matteo / CAPODICI Fabrizio / FRANCESCHINI D

### POR - Portugal

- [1] CARAPINHA J. (GK)
- [3] DA SILVA OLIVEIRA Hugo
- [4] DA COSTA BRAS Gabriel (C)
- [5] OLIVEIRA D.
- [6] VILELA GAMA Joao Dinis
- [7] NOBREGA MARQUES Ricardo Miguel
- [9] BUCANCIL NABIAN Herculano
- [10] SOUSA CRUZ Marco
- [11] MONTEIRO MEIRELES Jorge
- [14] ALMEIDA MACEDO Jose Pedro
- [15] ALVES G.

#### Substitutes

- [2] PARREIRA PARENTE Tiago
- [8] FELIX SEQUEIRA Hugo
- [12] AZEVEDO G. (GK)
- [13] PINHEIRO MONTEIRO Diogo
- [16] AGUIAR GOMES Bernardo Martim
- [17] RODRIGUES CARVALHO Lucas
- [18] MARIANO FALE Miguel Maria

**Coach** DA COSTA MILHEIRO Joaquim Alberto / DELGADO PEIXE Emilio Manuel / LO

### Cautions:

KUMI , BOZZOLAN , FELIX SEQUEIRA , PATANE'

### Expulsions:

### Additional Time:



SUN 26 JUN 2022

Start Time 20:00

## Match Report ITA vs POR

1:0

### ITA - Italy

11  
5  
23  
5  
20  
0  
3  
0  
3  
0  
0

### STATISTICS

Shots  
Shots on Goal  
Fouls  
Corner Kicks  
Free Kicks  
Penalty Kicks  
Offsides  
Own Goals  
Yellow Cards (Cautions)  
Expulsions (2nd Yellow)  
Red Cards (Expulsions)  
Ball Possession  
Actual Playing Time

### POR - Portugal

14  
8  
20  
2  
26  
1  
0  
0  
1  
0  
0

### ITA - Italy

No.	Name	Pos	Min	GF	GA	SG/S	PK	Fouls		Y	Red Cards	
								FC	FS		2Y=R	R
<b>Totals</b>				1		5/11		23	20	3		

### POR - Portugal

No.	Name	Pos	Min	GF	GA	SG/S	PK	Fouls		Y	Red Cards	
								FC	FS		2Y=R	R
<b>Totals</b>					1	8/14	0/1	20	20	1		

### LEGEND

(C)	Captain	+nn	Time when player substituted in	2Y=R	2nd Yellow = Red Card	AET	After Extra Time
DF	Defender	FC	Fouls Committed	FS	Fouls Suffered	FW	Forward
GA	Goals Against	GF	Goals for	GK	Goalkeeper	MF	Midfielder
R	Red Cards (Expulsions)	SG/S	Shots on Goal/Shots	Y	Yellow Card	PSO	Penalty Shoot-out



SUN 26 JUN 2022  
Start Time 17:00  
Game Duration: 01:51

## Match Report GRE vs TUR 1:2 (0:2)

### Match Officials:

**Referee:** Jérémie PIGNARD (FRA)  
**Assistant Referee 1:** Brahim HAMLAOUI (ALG)  
**Assistant Referee 2:** Sara KEMAD (ALG)  
**4th Official:** Lamia ATMAN (ALG)

### Goal Scored:

YILMAZ 39' Action Goal, BICER 45'+1' Action Goal, VOLAKIS 81' Action Goal

### GRE - Greece

[1] BOTIS Nikolaos Nestoras (GK)  
[2] KOTTAS Dimitrios (-62')  
[4] KERAMITSIS Dimitrios  
[5] CHRISTOU Nikolaos (-80')  
[6] KYRIOPOULOS Georgios (-45')  
[10] KOUTSIAS Georgios (C) (-62')  
[14] GEORGIADIS Charalampos  
[15] PRODROMITIS Athanasios  
[17] SMYRLIS Lampros (-79')  
[18] GKITERSOS Ioannis  
[19] FILON Marios Taxiarchis

#### Substitutes

[3] TASIOURAS Eleftherios  
[7] TSIKOS Zisis (+62')  
[8] GKOLFINOS Alexios (+62')  
[9] SPYRAKOS Nikolaos (+45')  
[11] VOLAKIS Konstantinos (+79')  
[12] MONASTIRLIS Dimitrios (GK)  
[16] SYMEONIDIS Anastasios (+80')

**Coach** THEOS Anastasios / ALEXIADIS Alexandros

### Cautions:

SENYURT 54' , PRODROMITIS 71' , KEFELI 78' , KABASAKAL 85'

### Expulsions:

### Additional Time:

1st Half: 0 min., 2nd Half: 5 min.

### TUR - Turkey

[2] TUNALI Eren  
[3] TINTIS Emir (C)  
[4] KAVAS Yasar  
[5] YILMAZ Ali Sahin (-69')  
[6] SATILMIS Sami  
[7] BICER Habib (-69')  
[10] SENYURT Devran (-57')  
[12] SERHAT Oztasdelen  
[16] KEFELI Yunus Emre  
[17] PINARCI M. (-57')  
[18] KILIC Ali

#### Substitutes

[1] YILMAZ Jankat  
[8] GUNDUZ Teoman  
[9] KARADEMIR Ahmet (+69')  
[11] BUYUKSAYAR Mehmet Ali (+57')  
[13] MEHMET ENES Gulalan  
[14] ORTAKAYA Emir (+69')  
[15] KABASAKAL Ulusoy Mert (+57')

**Coach** HACIOGLU Mehmet / BOLUKBASI Mehmet / BASOGLU Cihan Mert / YESILDA



SUN 26 JUN 2022  
Start Time 17:00  
Game Duration: 01:51

## Match Report

### GRE vs TUR

1:2 (0:2)

**GRE - Greece**

6  
1  
10  
2  
12  
0  
1  
0  
1  
0  
1  
0  
0  
45%  
27

**STATISTICS**

Shots  
Shots on Goal  
Fouls  
Corner Kicks  
Free Kicks  
Penalty Kicks  
Offsides  
Own Goals  
Yellow Cards (Cautions)  
Expulsions (2nd Yellow)  
Red Cards (Expulsions)  
Ball Possession  
Actual Playing Time

**TUR - Turkey**

11  
6  
12  
4  
11  
0  
0  
0  
3  
0  
0  
55%  
33

**GRE - Greece**

No.	Name	Pos	Min	GF	GA	SG/S	PK	Fouls		Y	Red Cards	
								FC	FS		2Y=R	R
1	BOTIS Nikolaos Nestoras	GK	95		2							
2	KOTTAS Dimitrios		62					1				
4	KERAMITSIS Dimitrios	DF	95			0/1		1				
5	CHRISTOU Nikolaos	DF	79					2				
6	KYRIOPOULOS Georgios	MF	45			0/1						
10	KOUTSIAS Georgios (C)	FW	62			0/1		1	3			
14	GEORGIADIS Charalampos	DF	95					1	1			
15	PRODROMITIS Athanasios	DF	95					1	1	1		
17	SMYRLIS Lampros	MF	79						1			
18	GKITEROS Ioannis	FW	95			0/1		2	1			
19	FILON Marios Taxiarchis	DF	95					1	1			
<b>Substitutes</b>												
7	TSIKOS Zisis	MF	33			0/1						
8	GKOLFINOS Alexios		33									
9	SPYRAKOS Nikolaos	MF	50						1			
11	VOLAKIS Konstantinos	MF	16	1		1/1						
16	SYMEONIDIS Anastasios	MF	16						1			
<b>Totals</b>				1	2	1/6		10	10	1		

**TUR - Turkey**

No.	Name	Pos	Min	GF	GA	SG/S	PK	Fouls		Y	Red Cards	
								FC	FS		2Y=R	R
2	TUNALI Eren		95						1			
3	TINTIS Emir (C)		95						2			
4	KAVAS Yasar		95					1				
5	YILMAZ Ali Sahin		69	1		2/2		1	2			
6	SATILMIS Sami		95					3				
7	BICER Habib		69	1		4/5		1	2			
10	SENYURT Devran		56			0/1		2		1		
12	SERHAT Oztasdelen		95		1							
16	KEFELI Yunus Emre		95					2		1		
17	PINARCI Muhammed Mustafa		57						1			
18	KILIC Ali		95			0/2			2			
<b>Substitutes</b>												
9	KARADEMIR Ahmet		26					1	1			
11	BUYUKSAYAR Mehmet Ali		38									
14	ORTAKAYA Emir		26			0/1						
15	KABASAKAL Ulusoy Mert		39					1		1		
<b>Totals</b>				2	1	6/11		12	11	3		



Stade Mers El Hadjad

Football

Men

Preliminary - Group B

Match 4



SUN 26 JUN 2022  
Start Time 17:00  
Game Duration: 01:51

**Match Report**  
**GRE vs TUR**  
1:2 (0:2)

**LEGEND**

<b>(C)</b> Captain	<b>+nn</b> Time when player substituted in	<b>2Y=R</b> 2nd Yellow = Red Card	<b>AET</b> After Extra Time
<b>DF</b> Defender	<b>FC</b> Fouls Committed	<b>FS</b> Fouls Suffered	<b>FW</b> Forward
<b>GA</b> Goals Against	<b>GF</b> Goals for	<b>GK</b> Goalkeeper	<b>MF</b> Midfielder
<b>R</b> Red Cards (Expulsions)	<b>SG/S</b> Shots on Goal/Shots	<b>Y</b> Yellow Card	<b>PSO</b> Penalty Shoot-out



TUE 28 JUN 2022  
Start Time 20:00  
Game Duration: 01:52

**Match Report**  
**POR vs TUR**  
**2:0 (1:0)**

**Match Officials:**

**Referee:** Youcef GAMOUH (ALG)  
**Assistant Referee 1:** Aurélien DROUET (FRA)  
**Assistant Referee 2:** Mohammed SERRADJ (ALG)  
**4th Official:** Jérémie PIGNARD (FRA)

**Goal Scored:**

MARIANO FALE 15' Action Goal, ALVES DE FREITAS 53' Penalty Goal

**POR - Portugal**

[4] DA COSTA G. (C) (-81')  
[5] OLIVEIRA D.  
[6] VILELA GAMA Joao Dinis (-72')  
[7] NOBREGA R. (-72')  
[8] FELIX SEQUEIRA Hugo  
[11] MONTEIRO MEIRELES Jorge  
[12] AZEVEDO G. (GK)  
[13] PINHEIRO MONTEIRO Diogo  
[14] ALMEIDA MACEDO Jose Pedro  
[15] ALVES G. (-62')  
[18] MARIANO M. (-62')

**Substitutes**

[1] CARAPINHA J. (GK)  
[2] PARREIRA PARENTE Tiago  
[3] DA SILVA OLIVEIRA Hugo (+81')  
[9] BUCANCIL H. (+62')  
[10] SOUSA CRUZ Marco (+72')  
[16] AGUIAR B. (+62')  
[17] RODRIGUES L. (+72')

**Coach** DA COSTA MILHEIRO Joaquim Alberto / DELGADO PEIXE Emilio Manuel / LO

**TUR - Turkiye**

[1] YILMAZ Jankat  
[3] TINTIS Emir (C)  
[5] YILMAZ Ali Sahin  
[6] SATILMIS Sami (-82')  
[7] BICER Habib (-45')  
[8] GUNDUZ Teoman (-45')  
[9] KARADEMIR Ahmet  
[13] MEHMET ENES Gulalan  
[14] ORTAKAYA Emir (-45')  
[16] KEFELI Yunus Emre (-45')  
[18] KILIC Ali

**Substitutes**

[2] TUNALI Eren (+45')  
[4] KAVAS Yasar (+45')  
[10] SENYURT Devran (+45')  
[11] BUYUKSAYAR Mehmet Ali (+45')  
[12] SERHAT Oztasdelen  
[15] KABASAKAL Ulusoy Mert  
[17] PINARCI M. (+82')

**Coach** HACIOGLU Mehmet / BOLUKBASI Mehmet / BASOGLU Cihan Mert / YESILDA

**Cautions:**

MEHMET ENES 17' , YILMAZ 30' , GUNDUZ 42' , ORTAKAYA 45'+3'

**Expulsions:**

MEHMET ENES 36' 2nd Yellow Card

**Additional Time:**

1st Half: 3 min., 2nd Half: 3 min.





TUE 28 JUN 2022  
Start Time 20:00  
Game Duration: 01:52

**Match Report**  
**POR vs TUR**  
**2:0 (1:0)**

**POR - Portugal**

15  
5  
14  
6  
20  
1  
2  
0  
0  
0  
0  
55%  
24

**STATISTICS**

Shots  
Shots on Goal  
Fouls  
Corner Kicks  
Free Kicks  
Penalty Kicks  
Offsides  
Own Goals  
Yellow Cards (Cautions)  
Expulsions (2nd Yellow)  
Red Cards (Expulsions)  
Ball Possession  
Actual Playing Time

**TUR - Turkiye**

7  
2  
16  
5  
16  
0  
4  
0  
4  
1  
0  
45%  
20

**POR - Portugal**

No.	Name	Pos	Min	GF	GA	SG/S	PK	Fouls		Y	Red Cards	
								FC	FS		2Y=R	R
4	DA COSTA BRAS Gabriel (C)	DF	84						1			
5	OLIVEIRA D.	DF	96					1				
6	VILELA GAMA Joao Dinis	MF	74					1	1			
7	NOBREGA MARQUES Ricardo Miquel	FW	75					1	1			
8	FELIX SEQUEIRA Hugo	MF	96			1/5			1			
11	MONTEIRO MEIRELES Jorge	FW	96			1/2		1	3			
12	AZEVEDO RIBEIRO Goncalo Miquel	GK	96									
13	PINHEIRO MONTEIRO Diogo	DF	96			0/1						
14	ALMEIDA MACEDO Jose Pedro	DF	96					2	1			
15	ALVES G.	MF	64	1		1/3	1/1	5	5			
18	MARIANO FALE Miquel Maria	FW	65	1		1/1			2			
<b>Substitutes</b>												
3	DA SILVA OLIVEIRA Hugo	DF	12									
9	BUCANCIL NABIAN Herculano	FW	31					1	1			
10	SOUSA CRUZ Marco	MF	22									
16	AGUIAR GOMES Bernardo Martim	MF	32					1				
17	RODRIGUES CARVALHO Lucas	FW	21			1/3		1				
<b>Totals</b>				2		5/15	1/1	14	16			

**TUR - Turkiye**

No.	Name	Pos	Min	GF	GA	SG/S	PK	Fouls		Y	Red Cards	
								FC	FS		2Y=R	R
1	YILMAZ Jankat		96		2							
3	TINTIS Emir (C)		96					3	1			
5	YILMAZ Ali Sahin		96			0/1		3	5	1		
6	SATILMIS Sami		84						1			
7	BICER Habib		48						1			
8	GUNDUZ Teoman		48					1	1	1		
9	KARADEMIR Ahmet		96									
13	MEHMET ENES Gulalan		36					1		1	1	
14	ORTAKAYA Emir		48					2		1		
16	KEFELI Yunus Emre		48			1/2		1				
18	KILIC Ali		96			1/1		1				
<b>Substitutes</b>												
2	TUNALI Eren		48									
4	KAVAS Yasar		48					1				
10	SENYURT Devran		48			0/1		2				
11	BUYUKSAYAR Mehmet Ali		48			0/2		1	3			
17	PINARCI Muhammed Mustafa		12						1			
<b>Totals</b>					2	2/7		16	13	4	1	



Stade Sig  
Football  
Men  
Preliminary - Group B  
Match 6



TUE 28 JUN 2022  
Start Time 20:00  
Game Duration: 01:52

**Match Report**  
**POR vs TUR**  
2:0 (1:0)

**LEGEND**

<b>(C)</b> Captain	<b>+nn</b> Time when player substituted in	<b>2Y=R</b> 2nd Yellow = Red Card	<b>AET</b> After Extra Time
<b>DF</b> Defender	<b>FC</b> Fouls Committed	<b>FS</b> Fouls Suffered	<b>FW</b> Forward
<b>GA</b> Goals Against	<b>GF</b> Goals for	<b>GK</b> Goalkeeper	<b>MF</b> Midfielder
<b>R</b> Red Cards (Expulsions)	<b>SG/S</b> Shots on Goal/Shots	<b>Y</b> Yellow Card	<b>PSO</b> Penalty Shoot-out



Stade Mers El Hadjadj

Football

Men

Preliminary - Group B

Match 8



TUE 28 JUN 2022  
Start Time 17:00  
Game Duration: 01:58

## Match Report ITA vs GRE 4:0 (0:0)

### Match Officials:

**Referee:** Iotfi BOUKOUASSA (ALG)  
**Assistant Referee 1:** ZERHOUNI (ALG)  
**Assistant Referee 2:** Adel ABANE (ALG)  
**4th Official:** Karim SABRY (ALG)

### Goal Scored:

RAIMONDO 47' Action Goal, RAIMONDO 65' Action Goal, D'ANDREA 79' Penalty Goal, RAIMONDO 90'+1' Penalty Goal

### ITA - Italy

[1] MASTRANTONIO Davide (GK)  
[2] MISSORI Filippo (C)  
[4] PALELLA Andrea (-76')  
[5] DELLAVALLE Lorenzo (-76')  
[7] HASA Luis (-63')  
[8] KUMI Justin  
[9] MANCINI Tommaso (-62')  
[13] BOZZOLAN Andrea  
[14] GUARINO Gabriele  
[15] AMATUCCI Lorenzo (-88')  
[18] RAIMONDO Antonio

#### Substitutes

[3] REGONESI Iacopo  
[6] INDRAGOLI Gabriele (+76')  
[10] ACCORNERO Federico (+88')  
[11] PATANE' Nicola (+76')  
[12] BAGNOLINI Nicola  
[16] IGNACCHITI Lorenzo (+63')  
[17] D'ANDREA Luca (+62')

**Coach** VARESCO Nicolo / BARELLA Matteo / CAPODICI Fabrizio / FRANCESCHINI D

### GRE - Greece

[1] BOTIS Nikolaos Nestoras (GK)  
[4] KERAMITSIS Dimitrios  
[5] CHRISTOU Nikolaos (C) (-79')  
[7] TSIKOS Zisis  
[8] GKOLFINOS Alexios (-52')  
[9] SPYRAKOS Nikolaos  
[14] GEORGIADIS Charalampos (-80')  
[15] PRODROMITIS Athanasios  
[16] SYMEONIDIS Anastasios (-79')  
[18] GKITERSOS Ioannis (-53')  
[19] FILON Marios Taxiarchis

#### Substitutes

[2] KOTTAS Dimitrios (+79')  
[3] TASIOURAS Eleftherios (+80')  
[6] KYRIOPOULOS Georgios (+79')  
[10] KOUTSIAS Georgios (+52')  
[11] VOLAKIS Konstantinos  
[12] MONASTIRLIS Dimitrios (GK)  
[17] SMYRLIS Lampros (+53')

**Coach** THEOS Anastasios / ALEXIADIS Alexandros

### Cautions:

KYRIOPOULOS 21'

### Expulsions:

### Additional Time:

1st Half: 3 min., 2nd Half: 3 min.



Stade Mers El Hadjadj

Football

Men

Preliminary - Group B

Match 8



TUE 28 JUN 2022  
Start Time 17:00  
Game Duration: 01:58

**Match Report**  
**ITA vs GRE**  
**4:0 (0:0)**

**ITA - Italy**

9  
5  
18  
3  
19  
2  
2  
0  
0  
0  
0  
0  
67%  
37

**STATISTICS**

Shots  
Shots on Goal  
Fouls  
Corner Kicks  
Free Kicks  
Penalty Kicks  
Offsides  
Own Goals  
Yellow Cards (Cautions)  
Expulsions (2nd Yellow)  
Red Cards (Expulsions)  
Ball Possession  
Actual Playing Time

**GRE - Greece**

4  
4  
19  
2  
20  
0  
0  
0  
1  
0  
0  
33%  
18

**ITA - Italy**

No.	Name	Pos	Min	GF	GA	SG/S	PK	Fouls		Y	Red Cards	
								FC	FS		2Y=R	R
1	MASTRANTONIO Davide	GK	96									
2	MISSORI Filippo (C)	DF	96					1	1			
4	PALELLA Andrea	MF	79					1	3			
5	DELLAVALLE Lorenzo	DF	79									
7	HASA Luis	MF	65						2			
8	KUMI Justin	MF	96			1/3		2				
9	MANCINI Tommaso	FW	65					4				
13	BOZZOLAN Andrea	DF	96			0/1		2	1			
14	GUARINO Gabriele	DF	96					3	1			
15	AMATUCCI Lorenzo	MF	90					2	2			
18	RAIMONDO Antonio	FW	96	3		3/3	1/1	2	4			
<b>Substitutes</b>												
6	INDRAGOLI Gabriele		17									
10	ACCORNERO Federico	MF	6									
11	PATANE' Nicola		17									
16	IGNACCHITI Lorenzo	MF	31					1	1			
17	D'ANDREA Luca		31	1		1/2	1/1		3			
<b>Totals</b>				4		5/9	2/2	18	18			

**GRE - Greece**

No.	Name	Pos	Min	GF	GA	SG/S	PK	Fouls		Y	Red Cards	
								FC	FS		2Y=R	R
1	BOTIS Nikolaos Nestoras	GK	96		4							
4	KERAMITSIS Dimitrios	DF	96			1/1		1				
5	CHRISTOU Nikolaos (C)	DF	82					3	4			
7	TSIKOS Zisis	MF	96					3	1			
8	GKOLFINOS Alexios		55					1				
9	SPYRAKOS Nikolaos	MF	96			1/1		3				
14	GEORGIADIS Charalampos	DF	82						1			
15	PRODROMITIS Athanasios	DF	96					2	1			
16	SYMEONIDIS Anastasios	MF	82					1	1			
18	GKITERSOS Ioannis	FW	55			1/1		4	1			
19	FILON Marios Taxiarchis	DF	96					1	2			
<b>Substitutes</b>												
2	KOTTAS Dimitrios		14									
3	TASIOURAS Eleftherios	DF	14									
6	KYRIOPOULOS Georgios	MF	14						1	1		
10	KOUTSIAS Georgios	FW	41						2			
17	SMYRLIS Lampros	MF	41			1/1			2			
<b>Totals</b>				4		4/4		19	16	1		



Stade Mers El Hadjadj

Football

Men

Preliminary - Group B

Match 8



TUE 28 JUN 2022

Start Time 17:00

Game Duration: 01:58

## Match Report

ITA vs GRE

4:0 (0:0)

### LEGEND

<b>(C)</b> Captain	<b>+nn</b> Time when player substituted in	<b>2Y=R</b> 2nd Yellow = Red Card	<b>AET</b> After Extra Time
<b>DF</b> Defender	<b>FC</b> Fouls Committed	<b>FS</b> Fouls Suffered	<b>FW</b> Forward
<b>GA</b> Goals Against	<b>GF</b> Goals for	<b>GK</b> Goalkeeper	<b>MF</b> Midfielder
<b>R</b> Red Cards (Expulsions)	<b>SG/S</b> Shots on Goal/Shots	<b>Y</b> Yellow Card	<b>PSO</b> Penalty Shoot-out



THU 30 JUN 2022  
Start Time 17:00  
Game Duration: 01:55

## Match Report POR vs GRE 0:2 (0:0)

### Match Officials:

**Referee:** Lamia ATMAN (ALG)  
**Assistant Referee 1:** Hamzi BOUZIT  
**Assistant Referee 2:** Amii BELAROUSSI  
**4th Official:** Zorbay KUCUK (TUR)

### Goal Scored:

KOUTSIAS 76' Fastbreak Goal, KOUTSIAS 79' Action Goal

### POR - Portugal

[4] DA COSTA BRAS Gabriel (C)  
[5] OLIVEIRA D.  
[6] VILELA GAMA Joao Dinis (-80')  
[7] NOBREGA R. (-82')  
[8] FELIX SEQUEIRA Hugo (-80')  
[12] AZEVEDO G. (GK)  
[13] PINHEIRO MONTEIRO Diogo  
[14] ALMEIDA MACEDO Jose Pedro  
[15] ALVES G.  
[17] RODRIGUES L. (-64')  
[18] MARIANO M. (-63')

#### Substitutes

[1] CARAPINHA J. (GK)  
[2] PARREIRA PARENTE Tiago (+82')  
[3] DA SILVA OLIVEIRA Hugo  
[9] BUCANCIL H. (+63')  
[10] SOUSA CRUZ Marco (+80')  
[11] MONTEIRO MEIRELES Jorge (+64')  
[16] AGUIAR B. (+80')

**Coach** DA COSTA MILHEIRO Joaquim Alberto / DELGADO PEIXE Emilio Manuel / LO

### GRE - Greece

[2] KOTTAS Dimitrios  
[3] TASIOURAS Eleftherios (-45')  
[4] KERAMITSIS Dimitrios  
[5] CHRISTOU Nikolaos  
[7] TSIKOS Zisis (-59')  
[9] SPYRAKOS Nikolaos (-90')  
[10] KOUTSIAS Georgios (C)  
[12] MONASTIRLIS Dimitrios (GK)  
[15] PRODROMITIS Athanasios  
[17] SMYRLIS Lampros (-59')  
[19] FILON Marios Taxiarchis

#### Substitutes

[1] BOTIS Nikolaos Nestoras (GK)  
[6] KYRIOPOULOS Georgios  
[8] GKOLFINOS Alexios (+90')  
[11] VOLAKIS Konstantinos  
[14] GEORGIADIS Charalampos (+45')  
[16] SYMEONIDIS Anastasios (+59')  
[18] GKITERSOS Ioannis (+59')

**Coach** THEOS Anastasios / ALEXIADIS Alexandros

### Cautions:

TSIKOS 55' , CHRISTOU 90'+5'

### Expulsions:

### Additional Time:

1st Half: 2 min., 2nd Half: 5 min.



THU 30 JUN 2022  
Start Time 17:00  
Game Duration: 01:55

**Match Report**  
**POR vs GRE**  
**0:2 (0:0)**

**POR - Portugal**

22  
9  
17  
5  
30  
0  
0  
0  
0  
0  
0  
0  
0  
0  
0  
59%  
26

**STATISTICS**

Shots  
Shots on Goal  
Fouls  
Corner Kicks  
Free Kicks  
Penalty Kicks  
Offsides  
Own Goals  
Yellow Cards (Cautions)  
Expulsions (2nd Yellow)  
Red Cards (Expulsions)  
Ball Possession  
Actual Playing Time

**GRE - Greece**

8  
7  
26  
1  
17  
0  
4  
0  
2  
0  
0  
41%  
18

**POR - Portugal**

No.	Name	Pos	Min	GF	GA	SG/S	PK	Fouls		Y	Red Cards	
								FC	FS		2Y=R	R
4	DA COSTA BRAS Gabriel (C)	DF	97			0/1						
5	OLIVEIRA D.	DF	97			1/1		4	2			
6	VILELA GAMA Joao Dinis	MF	81			0/1						
7	NOBREGA MARQUES Ricardo Miquel	FW	83			1/3		1	1			
8	FELIX SEQUEIRA Hugo	MF	81			1/5		2	6			
12	AZEVEDO RIBEIRO Goncalo Miquel	GK	97		2							
13	PINHEIRO MONTEIRO Diao	DF	97			1/2			1			
14	ALMEIDA MACEDO Jose Pedro	DF	97			2/2		3	1			
15	ALVES G.	MF	97			1/1		2	8			
17	RODRIGUES CARVALHO Lucas	FW	65			2/3		1	2			
18	MARIANO FALE Miquel Maria	FW	65			0/2		1				
<b>Substitutes</b>												
2	PARREIRA PARENTE Tiago	DF	14									
9	BUCANCIL NABIAN Herculano	FW	32					1	1			
10	SOUSA CRUZ Marco	MF	16			0/1		1	1			
11	MONTEIRO MEIRELES Jorge	FW	32					1	2			
16	AGUIAR GOMES Bernardo Martim	MF	16						1			
<b>Totals</b>					2	9/22		17	26			

**GRE - Greece**

No.	Name	Pos	Min	GF	GA	SG/S	PK	Fouls		Y	Red Cards	
								FC	FS		2Y=R	R
2	KOTTAS Dimitrios	DF	97					3	1			
3	TASIOURAS Eleftherios	DF	47					2	1			
4	KERAMITSIS Dimitrios	DF	97					1	2			
5	CHRISTOU Nikolaos	DF	97			0/1		4	2	1		
7	TSIKOS Zisis	MF	60					5		1		
9	SPYRAKOS Nikolaos	MF	91					4	1			
10	KOUTSIAS Georgios (C)	FW	97	2		6/6			3			
12	MONASTIRLIS Dimitrios	GK	97									
15	PRODRIMITIS Athanasios	DF	97					1	3			
17	SMYRLIS Lampros	MF	60					2	2			
19	FILON Marios Taxiarchis	DF	97					1	2			
<b>Substitutes</b>												
8	GKOLFINS Alexios	FW	6									
14	GEORGIADIS Charalampos	DF	50			1/1						
16	SYMEONIDIS Anastasios	MF	37					3				
18	GKITERSOS Ioannis	FW	36						1			
<b>Totals</b>				2		7/8		26	18	2		



Stade Sig  
Football  
Men  
Preliminary - Group B  
Match 9



THU 30 JUN 2022  
Start Time 17:00  
Game Duration: 01:55

**Match Report**  
**POR vs GRE**  
0:2 (0:0)

**LEGEND**

<b>(C)</b> Captain	<b>+nn</b> Time when player substituted in	<b>2Y=R</b> 2nd Yellow = Red Card	<b>AET</b> After Extra Time
<b>DF</b> Defender	<b>FC</b> Fouls Committed	<b>FS</b> Fouls Suffered	<b>FW</b> Forward
<b>GA</b> Goals Against	<b>GF</b> Goals for	<b>GK</b> Goalkeeper	<b>MF</b> Midfielder
<b>R</b> Red Cards (Expulsions)	<b>SG/S</b> Shots on Goal/Shots	<b>Y</b> Yellow Card	<b>PSO</b> Penalty Shoot-out





THU 30 JUN 2022  
Start Time 17:00  
Game Duration: 02:54

## Match Report

### TUR vs ITA

0:0

#### Match Officials:

**Referee:** Amir LOUCIF (TUN)  
**Assistant Referee 1:** Brahim HAMLAOUI (ALG)  
**Assistant Referee 2:** Sara KEMMAD (ALG)  
**4th Official:** Loutfi BEKOUASSA (ALG)

#### Goal Scored:

#### TUR - Turkiye

[1] YILMAZ Jankat (GK)  
[2] TUNALI Eren  
[3] TINTIS Emir  
[4] KAVAS Yasar (-39')  
[5] YILMAZ Ali Sahin  
[6] SATILMIS Sami (-71')  
[8] GUNDUZ Teoman (-70')  
[9] KARADENIR Ahmed  
[10] SENYURT Devran (-70')  
[16] KEFELI Yunus Emre (-57')  
[18] KILIC Ali

#### Substitutes

[7] BICER Habib (+57')  
[11] BUYUKSAYAR Mehmet Ali (+70')  
[12] SERHAT Oztasdelen (GK)  
[13] MEHMET ENES Gulalan  
[14] ORTAKAYA Emir (+39')  
[15] KABASAKAL Ulusoy Mert (+70')  
[17] PINARCI M. (+71')

**Coach** HACIOGLU Mehmet / BOLUKBASI Mehmet / BASOGLU Cihan Mert / YESILDA

#### Cautions:

#### Expulsions:

#### Additional Time:

1st Half: 2 min., 2nd Half: 4 min.

#### ITA - Italy

[1] MASTRANTONIO Davide (GK)  
[2] MISSORI Filippo (C) (-45')  
[3] REGONESI Iacopo  
[4] PALELLA Andrea (-40')  
[6] INDRAGOLI Gabriele  
[9] MANCINI Tommaso (-81')  
[10] ACCORNERO Federico (-45')  
[11] PATANE' Nicola  
[14] GUARINO Gabriele  
[15] AMATUCCI Lorenzo (-66')  
[16] IGNACCHITI Lorenzo

#### Substitutes

[5] DELLAVALLE Lorenzo (+45')  
[7] HASA Luis (+40')  
[8] KUMI Justin (+66')  
[12] BAGNOLINI Nicola (GK)  
[13] BOZZOLAN Andrea  
[17] D'ANDREA Luca (+45')  
[18] RAIMONDO Antonio (+81')

**Coach** VARESCO Nicolo / BARELLA Matteo / CAPODICI Fabrizio / FRANCESCHINI D



THU 30 JUN 2022  
Start Time 17:00  
Game Duration: 02:54

## Match Report

### TUR vs ITA

0:0

**TUR - Turkiye**

7  
3  
22  
5  
23  
0  
1  
0  
0  
0  
0  
0  
43%  
29

**STATISTICS**

Shots  
Shots on Goal  
Fouls  
Corner Kicks  
Free Kicks  
Penalty Kicks  
Offsides  
Own Goals  
Yellow Cards (Cautions)  
Expulsions (2nd Yellow)  
Red Cards (Expulsions)  
Ball Possession  
Actual Playing Time

**ITA - Italy**

7  
2  
16  
4  
23  
0  
6  
0  
0  
0  
0  
57%  
39

**TUR - Turkiye**

No.	Name	Pos	Min	GF	GA	SG/S	PK	Fouls		Y	Red Cards		
								FC	FS		2Y=R	R	
1	YILMAZ Jankat	GK	96						1				
2	TUNALI Eren	DF	96						3				
3	TINTIS Emir	DF	96			0/1		1					
4	KAVAS Yasar	DF	39					1	2				
5	YILMAZ Ali Sahin	DF	96			0/2		3	1				
6	SATILMIS Sami	MF	72			1/1		5	2				
8	GUNDUZ Teoman	MF	72			1/1							
9	KARADENIR Ahmed	FW	96					3	1				
10	SENYURT Devran	MF	72					2	1				
16	KEFELI Yunus Emre	FW	58			0/1		2					
18	KILIC Ali	FW	96					2	1				
<b>Substitutes</b>													
7	BICER Habib	FW	38					1	1				
11	BUYUKSAYAR Mehmet Ali	MF	24					2					
14	ORTAKAYA Emir	DF	57						1				
15	KABASAKAL Ulusoy Mert	MF	24			1/1							
17	PINARCI Muhammed Mustafa	MF	24										
<b>Totals</b>								3/7	22	14			

**ITA - Italy**

No.	Name	Pos	Min	GF	GA	SG/S	PK	Fouls		Y	Red Cards		
								FC	FS		2Y=R	R	
1	MASTRANTONIO Davide	GK	96										
2	MISSORI Filippo (C)	DF	47										
3	REGONESI Iacopo	DF	96					2	3				
4	PALELLA Andrea	MF	39						2				
6	INDRAGOLI Gabriele	DF	96					1	1				
9	MANCINI Tommaso	FW	82			1/1		2	4				
10	ACCORNERO Federico	MF	47			0/1		2					
11	PATANE' Nicola	MF	96					1	2				
14	GUARINO Gabriele	DF	96					2					
15	AMATUCCI Lorenzo	MF	68					2					
16	IGNACCHITI Lorenzo	MF	96					2	1				
<b>Substitutes</b>													
5	DELLAVALLE Lorenzo	DF	49						2				
7	HASA Luis	MF	57			0/2			5				
8	KUMI Justin	MF	28					1					
17	D'ANDREA Luca	FW	49			1/3		1					
18	RAIMONDO Antonio	FW	14										
<b>Totals</b>								2/7	16	20			



Stade Mers El Hadjadj

Football

Men

Preliminary - Group B

Match 10



THU 30 JUN 2022  
Start Time 17:00  
Game Duration: 02:54

**Match Report**  
**TUR vs ITA**  
0:0

**LEGEND**

<b>(C)</b> Captain	<b>+nn</b> Time when player substituted in	<b>2Y=R</b> 2nd Yellow = Red Card	<b>AET</b> After Extra Time
<b>DF</b> Defender	<b>FC</b> Fouls Committed	<b>FS</b> Fouls Suffered	<b>FW</b> Forward
<b>GA</b> Goals Against	<b>GF</b> Goals for	<b>GK</b> Goalkeeper	<b>MF</b> Midfielder
<b>R</b> Red Cards (Expulsions)	<b>SG/S</b> Shots on Goal/Shots	<b>Y</b> Yellow Card	<b>PSO</b> Penalty Shoot-out



SAT 2 JUL 2022  
Start Time 17:30  
Game Duration: 01:56

**Match Report**  
**FRA vs TUR**  
**2:0 (1:0)**

**Match Officials:**

**Referee:** Youcef GAMOUH (ALG)  
**Assistant Referee 1:** Mohammed SERRADJ (ALG)  
**Assistant Referee 2:** Karim del SABRY (ALG)  
**4th Official:** Hamzi BOUZIT (ALG)

**Goal Scored:**

MESSOUSSA 10' Action Goal, IKIA DIMI 84' Action Goal

**FRA - France**

[1] PATOUILLET Mathieu Franck (GK)  
[2] LOUIS-JEAN Johaneke Henri  
[3] KABA Kanfory (-83')  
[4] MERCIER Kevin Mathis  
[6] BUAYI KIALA Nathan (C)  
[9] KANOUTE Mahamadou (-45')  
[12] BOLUMBU D.  
[13] EL HANNACH Younes Mohamed  
[14] BONGEMBA Edvin (-66')  
[15] BOUANANI Badredine (-45')  
[17] MESSOUSSA A. (-66')

**Substitutes**

[5] CHIESA Ange (+83')  
[7] PIRRINGUEL Lenny Seive (+45')  
[8] DOUMBIA Cheick Mohamed  
[10] BELAHYANE Reda (+45')  
[11] BACAHA Mohamed Adel (+66')  
[16] ZADI Alain Georges (GK)  
[18] IKIA DIMI Yvan Junior (+66')

**Coach** ROUXEL Lionel

**Cautions:**

KEFELI 32' , TUNALI 56' , BELAHYANE 68'

**Expulsions:**

**Additional Time:**

1st Half: 3 min., 2nd Half: 4 min.

**TUR - Turkiye**

[1] YILMAZ Jankat (GK)  
[2] TUNALI Eren (-86')  
[3] TINTIS Emir (C)  
[4] KAVAS Yasar  
[6] SATILMIS Sami  
[8] GUNDUZ Teoman (-45')  
[9] KARADENIR Ahmed  
[10] SENYURT Devran (-45')  
[14] ORTAKAYA Emir  
[16] KEFELI Yunus Emre (-59')  
[18] KILIC Ali (-65')

**Substitutes**

[5] YILMAZ Ali Sahin  
[7] BICER Habib (+45')  
[11] BUYUKSAYAR Mehmet Ali (+65')  
[12] SERHAT Oztasdelen (GK)  
[13] MEHMET ENES Gulalan (+86')  
[15] KABASAKAL Ulusoy Mert (+45')  
[17] PINARCI M. (+59')

**Coach** HACIOGLU Mehmet / BOLUKBASI Mehmet / BASOGLU Cihan Mert / YESILDA

 SAT 2 JUL 2022  
 Start Time 17:30  
 Game Duration: 01:56

**Match Report**  
**FRA vs TUR**  
**2:0 (1:0)**
**FRA - France**

 3  
 3  
 12  
 0  
 18  
 0  
 3  
 0  
 1  
 0  
 0  
 0  
 39%  
 26

**STATISTICS**

 Shots  
 Shots on Goal  
 Fouls  
 Corner Kicks  
 Free Kicks  
 Penalty Kicks  
 Offsides  
 Own Goals  
 Yellow Cards (Cautions)  
 Expulsions (2nd Yellow)  
 Red Cards (Expulsions)  
 Ball Possession  
 Actual Playing Time

**TUR - Turkiye**

 11  
 6  
 14  
 5  
 15  
 0  
 4  
 0  
 2  
 0  
 0  
 61%  
 41

**FRA - France**

No.	Name	Pos	Min	GF	GA	SG/S	PK	Fouls		Y	Red Cards	
								FC	FS		2Y=R	R
1	PATOUILLET Mathieu Franck	GK	97									
2	LOUIS-JEAN Johaneke Henri	DF	97						2			
3	KABA Kanfory	DF	85					1	2			
4	MERCIER Kevin Mathis	DF	97					1				
6	BUAYI KIALA Nathan (C)	MF	97						2			
9	KANOUTE Mahamadou	FW	48			1/1		1				
12	BOLUMBU D.	DF	97						2			
13	EL HANNACH Younes Mohamed	DF	97						1			
14	BONGEMBA Edvin	MF	68						1			
15	BOUANANI Badredine	FW	48					1	1			
17	MESSOUSSA Amine Abdelrahmane	FW	68	1		1/1		4				
<b>Substitutes</b>												
5	CHIESA Ange	DF	12									
7	PIRRINGUEL Lenny Seive	MF	49						1			
10	BELAHYANE Reda	MF	49					2	2	1		
11	BACAHA Mohamed Adel	FW	29									
18	IKIA DIMI Yvan Junior	FW	29	1		1/1		2				
<b>Totals</b>				2		3/3		12	14	1		

**TUR - Turkiye**

No.	Name	Pos	Min	GF	GA	SG/S	PK	Fouls		Y	Red Cards	
								FC	FS		2Y=R	R
1	YILMAZ Jankat	GK	97		2				1			
2	TUNALI Eren	DF	89					1	2	1		
3	TINTIS Emir (C)	DF	97			1/1						
4	KAVAS Yasar	DF	97			1/1			3			
6	SATILMIS Sami	MF	97			0/1			3			
8	GUNDUZ Teoman	MF	48			0/1		1				
9	KARADENIR Ahmed	FW	97					5				
10	SENYURT Devran	MF	48			1/1						
14	ORTAKAYA Emir	DF	97			1/1		1				
16	KEFELI Yunus Emre	FW	62			1/1		3		1		
18	KILIC Ali	FW	67			0/1		1	1			
<b>Substitutes</b>												
7	BICER Habib	FW	49			1/2						
11	BUYUKSAYAR Mehmet Ali	MF	30			0/1						
13	MEHMET ENES Gulalan	DF	8									
15	KABASAKAL Ulusoy Mert	MF	49						1			
17	PINARCI Muhammed Mustafa	MF	35					2	1			
<b>Totals</b>				2		6/11		14	12	2		



Stade Ahmed Zabana

Football

Men

Semi-finals

Match 13



SAT 2 JUL 2022  
Start Time 17:30  
Game Duration: 01:56

**Match Report**  
**FRA vs TUR**  
2:0 (1:0)

**LEGEND**

<b>(C)</b> Captain	<b>+nn</b> Time when player substituted in	<b>2Y=R</b> 2nd Yellow = Red Card	<b>AET</b> After Extra Time
<b>DF</b> Defender	<b>FC</b> Fouls Committed	<b>FS</b> Fouls Suffered	<b>FW</b> Forward
<b>GA</b> Goals Against	<b>GF</b> Goals for	<b>GK</b> Goalkeeper	<b>MF</b> Midfielder
<b>R</b> Red Cards (Expulsions)	<b>SG/S</b> Shots on Goal/Shots	<b>Y</b> Yellow Card	<b>PSO</b> Penalty Shoot-out



SAT 2 JUL 2022  
Start Time 21:00  
Game Duration: 01:51

## Match Report ITA vs MAR 2:1 (0:0)

### Match Officials:

**Referee:** Jérémie PIGNARD (FRA)  
**Assistant Referee 1:** Mohamed BAKIR (TUN)  
**Assistant Referee 2:** Wael HANNACHI (TUN)  
**4th Official:** Zorbay KUCUK (TUR)

### Goal Scored:

RAIMONDO 55' Action Goal, RAIMONDO 63' Action Goal, KHALIFI 90'+3' Penalty Goal

### ITA - Italy

[1] MASTRANTONIO Davide (GK)  
[2] MISSORI Filippo (C) (-81')  
[5] DELLAVALLE Lorenzo  
[8] KUMI Justin (-81')  
[10] ACCORNERO Federico (-62')  
[13] BOZZOLAN Andrea  
[14] GUARINO Gabriele  
[15] AMATUCCI Lorenzo  
[16] IGNACCHITI Lorenzo  
[17] D'ANDREA Luca (-75')  
[18] RAIMONDO Antonio

#### Substitutes

[3] REGONESI Iacopo (+62')  
[4] PALELLA Andrea  
[6] INDRAGOLI Gabriele (+81')  
[7] HASA Luis  
[9] MANCINI Tommaso (+75')  
[11] PATANE' Nicola (+81')  
[12] BAGNOLINI Nicola (GK)

**Coach** VARESCO Nicolo / BARELLA Matteo / CAPODICI Fabrizio / FRANCESCHINI D

### MAR - Morocco

[1] MAGO Elias  
[2] LANTAKI Wassim (-61')  
[3] AKHARRAZ Youness  
[4] AMMAL Abdessamad (-66')  
[5] EL HAMMAMI Ayoub  
[6] BAALLAL Abdellah (-61')  
[8] JAZOULI Mohammed Younes  
[9] SADIK Omar  
[14] ANHARI Hamza (-66')  
[15] BOUKHRES Othmane (C)  
[18] KHALIFI Yassine

#### Substitutes

[7] LYAKOUBI Oussama (+61')  
[11] MAURER Aiman (+61')  
[12] HASBI Walid  
[13] KHATIR Ahmed (+66')  
[16] TAMOUNE Anouar Khalid  
[17] RAIHANI Abdellah (+66')

**Coach** BAHA Nabil / BAGUI Abdelilah / DELHOMEL Gregory Georges / OUAHBI Moha

### Cautions:

SADIK 39', KHALIFI 44', RAIMONDO 85', RAIHANI 88'

### Expulsions:

### Additional Time:

1st Half: 1 min., 2nd Half: 5 min.



SAT 2 JUL 2022  
Start Time 21:00  
Game Duration: 01:51

**Match Report**  
**ITA vs MAR**  
**2:1 (0:0)**

**ITA - Italy**

5  
3  
7  
3  
8  
0  
6  
0  
1  
0  
0  
48%  
23

**STATISTICS**

Shots  
Shots on Goal  
Fouls  
Corner Kicks  
Free Kicks  
Penalty Kicks  
Offsides  
Own Goals  
Yellow Cards (Cautions)  
Expulsions (2nd Yellow)  
Red Cards (Expulsions)  
Ball Possession  
Actual Playing Time

**MAR - Morocco**

6  
5  
7  
5  
13  
1  
1  
0  
3  
0  
0  
52%  
25

**ITA - Italy**

No.	Name	Pos	Min	GF	GA	SG/S	PK	Fouls		Y	Red Cards	
								FC	FS		2Y=R	R
1	MASTRANTONIO Davide	GK	96		1							
2	MISSORI Filippo (C)	DF	81									
5	DELLAVALLE Lorenzo	DF	96					1	1			
8	KUMI Justin	MF	82						1			
10	ACCORNERO Federico	MF	62									
13	BOZZOLAN Andrea	DF	96					1	1			
14	GUARINO Gabriele	DF	96									
15	AMATUCCI Lorenzo	MF	96			0/1		2	2			
16	IGNACCHITI Lorenzo	MF	96			0/1						
17	D'ANDREA Luca	FW	75									
18	RAIMONDO Antonio	FW	96	2		3/3			1	1		
<b>Substitutes</b>												
3	REGONESI Iacopo	DF	34									
6	INDRAGOLI Gabriele	DF	15					1	1			
9	MANCINI Tommaso	FW	21									
11	PATANE' Nicola	MF	14					2				
<b>Totals</b>				2	1	3/5		7	7	1		

**MAR - Morocco**

No.	Name	Pos	Min	GF	GA	SG/S	PK	Fouls		Y	Red Cards	
								FC	FS		2Y=R	R
1	MAGO Elias		96		2							
2	LANTAKI Wassim		61					1				
3	AKHARRAZ Youness		96									
4	AMMAL Abdessamad		66									
5	EL HAMMAMI Ayoub		96					1				
6	BAALLAL Abdellah		61			1/2						
8	JAZOULI Mohammed Younes		96						1			
9	SADIK Omar		96			2/2		4	1	1		
14	ANHARI Hamza		67			1/1			1			
15	BOUKHRES Othmane (C)		96									
18	KHALIFI Yassine		96	1		1/1	1/1	1	3	1		
<b>Substitutes</b>												
7	LYAKOUBI Oussama		35									
11	MAURER Aiman		35						1			
13	KHATIR Ahmed		30									
17	RAIHANI Abdellah		29							1		
<b>Totals</b>				1	2	5/6	1/1	7	7	3		





Stade Sig  
Football  
Men  
Semi-finals  
Match 14



SAT 2 JUL 2022  
Start Time 21:00  
Game Duration: 01:51

**Match Report**  
**ITA vs MAR**  
**2:1 (0:0)**

**LEGEND**

<b>(C)</b> Captain	<b>+nn</b> Time when player substituted in	<b>2Y=R</b> 2nd Yellow = Red Card	<b>AET</b> After Extra Time
<b>DF</b> Defender	<b>FC</b> Fouls Committed	<b>FS</b> Fouls Suffered	<b>FW</b> Forward
<b>GA</b> Goals Against	<b>GF</b> Goals for	<b>GK</b> Goalkeeper	<b>MF</b> Midfielder
<b>R</b> Red Cards (Expulsions)	<b>SG/S</b> Shots on Goal/Shots	<b>Y</b> Yellow Card	<b>PSO</b> Penalty Shoot-out



MON 4 JUL 2022  
Start Time 20:45  
Game Duration: 01:50

**Match Report**  
**FRA vs ITA**  
**1:0 (0:0)**

Spectators: 25000

**Match Officials:**

**Referee:** Loutfi BEKOUASSA (ALG)  
**Assistant Referee 1:** ZERHOUNI A. (ALG)  
**Assistant Referee 2:** Adel ABANE (ALG)  
**4th Official:** Lamia ATMAN (ALG)

**Goal Scored:**

PIRRINGUEL 68' Action Goal

**FRA - France**

[2] LOUIS-JEAN Johaneke Henri  
[4] MERCIER Kevin Mathis  
[6] BUAYI KIALA Nathan (C)  
[7] PIRRINGUEL Lenny Seive  
[12] BOLUMBU D. (-89')  
[13] EL HANNACH Younes Mohamed  
[14] BONGEMBA Edvin  
[15] BOUANANI Badredine (-82')  
[16] ZADI Alain Georges (GK)  
[17] MESSOUSSA A. (-89')  
[18] IKIA DIMI Yvan Junior (-63')

**Substitutes**

[1] PATOUILLET Mathieu Franck (GK)  
[3] KABA Kanfory  
[5] CHIESA Ange (+82')  
[8] DOUMBIA Cheick Mohamed (+89')  
[9] KANOUTE Mahamadou (+89')  
[10] BELAHYANE Reda (+63')  
[11] BACAHA Mohamed Adel

**Coach** ROUXEL Lionel

**Cautions:**

MERCIER 64' , BOUANANI 82' , D'ANDREA 89'

**Expulsions:**

**Additional Time:**

1st Half: 0 min., 2nd Half: 4 min.

**ITA - Italy**

[1] MASTRANTONIO Davide (GK)  
[2] MISSORI Filippo (C) (-90'+1')  
[3] REGONESI Iacopo (-86')  
[5] DELLAVALLE Lorenzo  
[8] KUMI Justin  
[10] ACCORNERO Federico (-76')  
[14] GUARINO Gabriele  
[15] AMATUCCI Lorenzo (-85')  
[16] IGNACCHITI Lorenzo  
[17] D'ANDREA Luca  
[18] RAIMONDO Antonio

**Substitutes**

[4] PALELLA Andrea (+85')  
[6] INDRAGOLI Gabriele  
[7] HASA Luis  
[9] MANCINI Tommaso (+76')  
[11] PATANE' Nicola (+90'+1')  
[12] BAGNOLINI Nicola (GK)  
[13] BOZZOLAN Andrea (+86')

**Coach** VARESCO Nicolo / BARELLA Matteo / CAPODICI Fabrizio / FRANCESCHINI D



MON 4 JUL 2022  
Start Time 20:45  
Game Duration: 01:50

**Match Report**  
**FRA vs ITA**  
**1:0 (0:0)**

Spectators: 25000

**FRA - France**

7  
4  
9  
3  
18  
0  
0  
0  
2  
0  
0  
45%  
24

**STATISTICS**

Shots  
Shots on Goal  
Fouls  
Corner Kicks  
Free Kicks  
Penalty Kicks  
Offsides  
Own Goals  
Yellow Cards (Cautions)  
Expulsions (2nd Yellow)  
Red Cards (Expulsions)  
Ball Possession  
Actual Playing Time

**ITA - Italy**

13  
3  
15  
10  
9  
0  
3  
0  
1  
0  
0  
55%  
29

**FRA - France**

No.	Name	Pos	Min	GF	GA	SG/S	PK	Fouls		Y	Red Cards	
								FC	FS		2Y=R	R
2	LOUIS-JEAN Johaneke Henri	DF	94									
4	MERCIER Kevin Mathis	DF	94			0/1		3		1		
6	BUAYI KIALA Nathan (C)	MF	94						3			
7	PIRRINGUEL Lenny Seive	MF	94	1		2/2		1	2			
12	BOLUMBU D.	DF	88			1/1						
13	EL HANNACH Younes Mohamed	DF	94						1			
14	BONGEMBA Edvin	MF	94					2	2			
15	BOUANANI Badredine	FW	82			1/2			4	1		
16	ZADI Alain Georges	GK	94						1			
17	MESSOUSSA Amine Abdelrahmane	FW	88			0/1		1				
18	IKIA DIMI Yvan Junior	FW	62					1	1			
<b>Substitutes</b>												
5	CHIESA Ange	DF	12									
8	DOUMBIA Cheick Mohamed	MF	6					1				
9	KANOUTE Mahamadou	FW	6									
10	BELAHYANE Reda	MF	32						1			
<b>Totals</b>				1		4/7		9	15	2		

**ITA - Italy**

No.	Name	Pos	Min	GF	GA	SG/S	PK	Fouls		Y	Red Cards	
								FC	FS		2Y=R	R
1	MASTRANTONIO Davide	GK	94		1							
2	MISSORI Filippo (C)	DF	90						3			
3	REGONESI Iacopo	DF	85					3				
5	DELLAVALLE Lorenzo	DF	94									
8	KUMI Justin	MF	94					2	1			
10	ACCORNERO Federico	MF	75			1/4			1			
14	GUARINO Gabriele	DF	94			0/1		1				
15	AMATUCCI Lorenzo	MF	85					4	1			
16	IGNACCHITI Lorenzo	MF	94					1				
17	D'ANDREA Luca	FW	94			1/5		2	1	1		
18	RAIMONDO Antonio	FW	94			1/2		1	1			
<b>Substitutes</b>												
4	PALELLA Andrea	MF	9					1				
9	MANCINI Tommaso	FW	19			0/1			1			
11	PATANE' Nicola	MF	4									
13	BOZZOLAN Andrea	DF	9									
<b>Totals</b>					1	3/13		15	9	1		



Stade Complexe Olympique

Football

Men

Gold-medal Match

Match 16



MON 4 JUL 2022  
Start Time 20:45  
Game Duration: 01:50

**Match Report**  
**FRA vs ITA**  
1:0 (0:0)

Spectators: 25000

**LEGEND**

<b>(C)</b> Captain	<b>+nn</b> Time when player substituted in	<b>2Y=R</b> 2nd Yellow = Red Card	<b>AET</b> After Extra Time
<b>DF</b> Defender	<b>FC</b> Fouls Committed	<b>FS</b> Fouls Suffered	<b>FW</b> Forward
<b>GA</b> Goals Against	<b>GF</b> Goals for	<b>GK</b> Goalkeeper	<b>MF</b> Midfielder
<b>R</b> Red Cards (Expulsions)	<b>SG/S</b> Shots on Goal/Shots	<b>Y</b> Yellow Card	<b>PSO</b> Penalty Shoot-out



MON 4 JUL 2022  
Start Time 17:00  
Game Duration: 02:00

## Match Report TUR vs MAR 2:4 (1:1)

### Match Officials:

**Referee:** RIBEIRO B. (POR)  
**Assistant Referee 1:** Brahim HAMLAOUI (ALG)  
**Assistant Referee 2:** Sara KEMMAD (ALG)  
**4th Official:** Amir LOUCIF (TUN)

### Goal Scored:

BICER 15' Head Goal , ANHARI 45'+1' Action Goal, RAIHANI 47' Action Goal, BICER 58' Action Goal, MAURER 73' Action Goal, SADIK 86' Action Goal

### TUR - Turkiye

[1] YILMAZ Jankat (GK)  
[2] TUNALI Eren  
[3] TINTIS Emir (C)  
[4] KAVAS Yasar  
[5] YILMAZ Ali Sahin  
[6] SATILMIS Sami (-46')  
[7] BICER Habib  
[9] KARADENIR Ahmed  
[15] KABASAKAL Ulusoy Mert (-80')  
[16] KEFELI Yunus Emre (-46')  
[17] PINARCI Muhammed Mustafa

### Substitutes

[8] GUNDUZ Teoman  
[10] SENYURT Devran (+46')  
[11] BUYUKSAYAR Mehmet Ali (+80')  
[12] SERHAT Oztasdelen (GK)  
[13] MEHMET ENES Gulalan  
[14] ORTAKAYA Emir  
[18] KILIC Ali (+46')

**Coach** HACIOGLU Mehmet

### Cautions:

SATILMIS 21' , TINTIS 33' , ARHOUN 70' , RAIHANI 79'

### Expulsions:

### Additional Time:

1st Half: 0 min., 2nd Half: 5 min.

### MAR - Morocco

[7] LYAKOUBI Oussama (-66')  
[8] JAZOULI Mohammed Younes  
[10] ARHOUN Usama  
[11] MAURER Aiman (-78')  
[12] HASBI Walid (GK)  
[13] KHATIR Ahmed  
[14] ANHARI Hamza  
[15] BOUKHRES Othmane (C)  
[16] TAMOUNE Anouar Khalid (-66')  
[17] RAIHANI Abdellah (-79')  
[18] KHALIFI Yassine

### Substitutes

[1] MAGO Elias (GK)  
[2] LANTAKI Wassim (+66')  
[3] AKHARRAZ Youness (+79')  
[4] AMMAL Abdessamad  
[5] EL HAMMAMI Ayoub  
[6] BAALLAL Abdellah (+78') (-79')  
[9] SADIK Omar (+66')

**Coach** OUAHBI Mohamed



MON 4 JUL 2022  
Start Time 17:00  
Game Duration: 02:00

**Match Report**  
**TUR vs MAR**  
2:4 (1:1)

**TUR - Turkiye**

6  
4  
13  
2  
11  
0  
1  
0  
2  
0  
0  
44%  
20

**STATISTICS**

Shots  
Shots on Goal  
Fouls  
Corner Kicks  
Free Kicks  
Penalty Kicks  
Offsides  
Own Goals  
Yellow Cards (Cautions)  
Expulsions (2nd Yellow)  
Red Cards (Expulsions)  
Ball Possession  
Actual Playing Time

**MAR - Morocco**

11  
8  
7  
7  
14  
0  
4  
0  
2  
0  
0  
56%  
25

**TUR - Turkiye**

No.	Name	Pos	Min	GF	GA	SG/S	PK	Fouls		Y	Red Cards	
								FC	FS		2Y=R	R
1	YILMAZ Jankat	GK	95		4							
2	TUNALI Eren	DF	95					1				
3	TINTIS Emir (C)	DF	95					1	1	1		
4	KAVAS Yasar	DF	95					1				
5	YILMAZ Ali Sahin	DF	95					2				
6	SATILMIS Sami	MF	45					1	1	1		
7	BICER Habib	FW	95	2		2/2		3				
9	KARADENIR Ahmed	FW	95			1/2		1	4			
15	KABASAKAL Ulusoy Mert	MF	80					2				
16	KEFELI Yunus Emre	FW	45					1				
17	PINARCI Muhammed Mustafa	MF	95			1/1			1			
<b>Substitutes</b>												
10	SENYURT Devran	MF	50			0/1						
11	BUYUKSAYAR Mehmet Ali	MF	15									
18	KILIC Ali	FW	50									
<b>Totals</b>				2	4	4/6		13	7	2		

**MAR - Morocco**

No.	Name	Pos	Min	GF	GA	SG/S	PK	Fouls		Y	Red Cards	
								FC	FS		2Y=R	R
7	LYAKOUBI Oussama		66			0/1			3			
8	JAZOULI Mohammed Younes		95			1/1		1				
10	ARHOUN Usama		95					2		1		
11	MAURER Aiman		85	1		2/3			1			
12	HASBI Walid	GK	95		2							
13	KHATIR Ahmed		95					1	1			
14	ANHARI Hamza		95	1		2/2		2	1			
15	BOUKHRES Othmane (C)		95						1			
16	TAMOUNE Anouar Khalid		66									
17	RAIHANI Abdellah		79	1		1/1				1		
18	KHALIFI Yassine		95			0/1			4			
<b>Substitutes</b>												
2	LANTAKI Wassim		29					1				
3	AKHARRAZ Youness		16									
6	BAALLAL Abdellah		10						1			
9	SADIK Omar		29	1		2/2			1			
<b>Totals</b>				4	2	8/11		7	13	2		



Stade Complexe Olympique

Football

Men

Bronze-medal Match

Match 15



MON 4 JUL 2022  
Start Time 17:00  
Game Duration: 02:00

**Match Report**  
**TUR vs MAR**  
2:4 (1:1)

**LEGEND**

<b>(C)</b> Captain	<b>+nn</b> Time when player substituted in	<b>2Y=R</b> 2nd Yellow = Red Card	<b>AET</b> After Extra Time
<b>DF</b> Defender	<b>FC</b> Fouls Committed	<b>FS</b> Fouls Suffered	<b>FW</b> Forward
<b>GA</b> Goals Against	<b>GF</b> Goals for	<b>GK</b> Goalkeeper	<b>MF</b> Midfielder
<b>R</b> Red Cards (Expulsions)	<b>SG/S</b> Shots on Goal/Shots	<b>Y</b> Yellow Card	<b>PSO</b> Penalty Shoot-out



## Cumulative Statistics

As of MON 4 JUL 2022 at 23:30

ALG - Algeria

Including Game 16

No.	Name	Pos.	MP	AS	GF	GA	SG/S	PK	Fouls		Y	Red Cards	
									FC	FS		2Y=R	R
1	BOUMENGOUCHE Abdelaziz C		3			3							
2	ZAOUI Salah Eddine		3		1		1/1		4	6	1		
3	HANFOUG Fouad		3						2	2	1	1	
4	BOUNACER Abdessamed		3				1/2		3	9	2		
5	BOUZAHZAH Ouanisse		3						1				
6	LAALLAM Abdelghani		3										
7	ZULLIANI Edhy Yvan		3				1/3		5	4	1		
8	PUCH-HERRANTZ Mehdi Guiller		3		1		1/4		5	10			
9	CHEGRA Ivane		3		1		3/8	1/1	3	4	4		
10	OMAR Mohamed Rafik		3	1			3/6		2	6	1		
11	DOUGUI Adam		3				1/2		1	3			
12	DJADI Adam Ghybril		3						1		1		
13	AID AI Amin Mohamed		3						1	6			
14	NOTTEBAERE Djibril		3				0/1		1				
15	AKHRIB Lahlou		3				1/1				1		
16	BOUALAM Hamza		3			2							
17	ABDELKADER Mohamed Islem		3						1	1			
18	BEN MAZOUZ Mohamed Said		3				2/4		3	3			
<b>Totals</b>				1	3	5	14/32	1/1	33	54	8		1

Corner Kicks: 13

Penalty Kicks Against (Goal/Shots): 1/1

Own Goals: 0

Own Goals Against: 0

### LEGEND

2Y=R 2nd Yellow = Red Card

FC Fouls Committed

GF Goals for

Min Minutes Played

PK Penalty Kicks (Goals/Shots)

S Substitute

-

-

AET After Extra Time

FS Fouls Suffered

GK Goalkeeper

GK Not eligible to play

Pos Position

SG/S Shots on Goal/Shots

-

-

AS Assists

FW Forward

I Injured

No. Number

PSO Penalty Shoot-out

Y Yellow Card

-

-

DF Defender

GA Goals Against

MF Midfielder

No. Shirt Number

R Red Cards (Expulsions)





## Cumulative Statistics

As of MON 4 JUL 2022 at 23:30

ESP - Spain

Including Game 16

No.	Name	Pos.	MP	AS	GF	GA	SG/S	PK	Fouls		Y	Red Cards	
									FC	FS		2Y=R	R
1	ASTRALAGA ARANGUREN Ande	GK	3			2							
2	ALEMAN CASTILLO Carlos	DF	3				1/1		3				
3	FRESNEDA CORRALIZA Ivan	DF	3										
4	MOSQUERA IBARGUEN Cristhian	DF	3						3	2			
5	CASAS ARCAS Arnau	DF	3						3	1			
6	MARTINEZ SANTAMARIA Roger	MF	3				2/3		3	5	2		
7	BLANCO GOMEZ Fabio	FW	3				4/6		3	4			
8	MORAN IBANEZ Manuel Angel	MF	3				1/6		3	4	1		
9	DENIA DIAZ Marcos	FW	3				2/3		4				
10	GUERRERO LANDABASO Julen	MF	3				1/5			2			
11	EL JEBARI Salim	FW	3				0/4		1	2			
12	RODRIGUEZ MUNOZ Alvaro Dani	FW	3		1		1/4		2				
13	FERNANDEZ GONZALEZ Cesar	GK	3			1				1			
14	BASTIDA MOYA Alvaro	MF	3				1/3		1	1	1		
15	MENDES MENDES Tomas	MF	3							2			
16	VALLE GOMEZ Alex	DF	3		1		3/3		4	5			
17	GHARBI ALVAREZ Ismael	MF	3				2/4		5	5			
18	PUJOL PORTORREAL Edgar Cli	DF	3				0/1				1		
<b>Totals</b>					2	3	18/43	0/0	35	34	5		

Corner Kicks: 11  
 Penalty Kicks Against (Goal/Shots): 0/0  
 Own Goals: 0  
 Own Goals Against: 0

### LEGEND

<b>2Y=R</b> 2nd Yellow = Red Card	<b>AET</b> After Extra Time	<b>AS</b> Assists	<b>DF</b> Defender
<b>FC</b> Fouls Committed	<b>FS</b> Fouls Suffered	<b>FW</b> Forward	<b>GA</b> Goals Against
<b>GF</b> Goals for	<b>GK</b> Goalkeeper	<b>I</b> Injured	<b>MF</b> Midfielder
<b>Min</b> Minutes Played	<b>GK</b> Not eligible to play	<b>No.</b> Number	<b>No.</b> Shirt Number
<b>PK</b> Penalty Kicks (Goals/Shots)	<b>Pos</b> Position	<b>PSO</b> Penalty Shoot-out	<b>R</b> Red Cards (Expulsions)
<b>S</b> Substitute	<b>SG/S</b> Shots on Goal/Shots	<b>Y</b> Yellow Card	
-	-	-	
-	-	-	



## Cumulative Statistics

As of MON 4 JUL 2022 at 23:30

FRA - France

### Including Game 16

No.	Name	Pos.	MP	AS	GF	GA	SG/S	PK	Fouls		Y	Red Cards	
									FC	FS		2Y=R	R
1	PATOUILLET Mathieu Franck	GK	5			1					1		
2	LOUIS-JEAN Johaneke Henri	DF	5				0/1		3	5			
3	KABA Kanfory	DF	5						2	4			
4	MERCIER Kevin Mathis	DF	5				0/1		6	3	1		
5	CHIESA Ange	DF	5				0/1		2	1			
6	BUAYI KIALA Nathan	MF	5						2	7			
7	PIRRINGUEL Lenny Seive	MF	4	1	1		3/3		6	4	1		
8	DOUMBIA Cheick Mohamed	MF	5				0/3		1	2			
9	KANOUTE Mahamadou	FW	5				1/1		2				
10	BELAHYANE Reda	MF	5						7	5	1		
11	BACAHA Mohamed Adel	FW	5				1/3		3	1			
12	BOLUMBU SOMBO Diabe Ousma	DF	5				1/1		1	3			
13	EL HANNACH Younes Mohamed	DF	5						3	2	1		
14	BONGEMBA Edvin	MF	5						6	9			
15	BOUANANI Badredine	FW	5		1		8/11	1/1	3	9	2		
16	ZADI Alain Georges	GK	5			2				2			
17	MESSOUSSA Amine Abdelrahma	FW	5		4		6/9	1/1	13	1	1		
18	IKIA DIMI Yvan Junior	FW	5		2		4/4		6	3			
<b>Totals</b>				1	8	3	24/38	2/2	67	61	8		

Corner Kicks: 17  
 Penalty Kicks Against (Goal/Shots): 2/2  
 Own Goals: 0  
 Own Goals Against: 0

#### LEGEND

<b>2Y=R</b> 2nd Yellow = Red Card	<b>AET</b> After Extra Time	<b>AS</b> Assists	<b>DF</b> Defender
<b>FC</b> Fouls Committed	<b>FS</b> Fouls Suffered	<b>FW</b> Forward	<b>GA</b> Goals Against
<b>GF</b> Goals for	<b>GK</b> Goalkeeper	<b>I</b> Injured	<b>MF</b> Midfielder
<b>Min</b> Minutes Played	<b>GK</b> Not eligible to play	<b>No.</b> Number	<b>No.</b> Shirt Number
<b>PK</b> Penalty Kicks (Goals/Shots)	<b>Pos</b> Position	<b>PSO</b> Penalty Shoot-out	<b>R</b> Red Cards (Expulsions)
<b>S</b> Substitute	<b>SG/S</b> Shots on Goal/Shots	<b>Y</b> Yellow Card	
-	-	-	
-	-	-	



## Cumulative Statistics

As of MON 4 JUL 2022 at 23:30

GRE - Greece

Including Game 16

No.	Name	Pos.	MP	AS	GF	GA	SG/S	PK	Fouls		Y	Red Cards	
									FC	FS		2Y=R	R
1	BOTIS Nikolaos Nestoras	GK	3			6							
2	KOTTAS Dimitrios	DF	3						4	1			
3	TASIOURAS Eleftherios	DF	3						2	1			
4	KERAMITSIS Dimitrios	DF	3				1/2		3	2			
5	CHRISTOU Nikolaos	DF	3				0/1		9	6	1		
6	KYRIOPOULOS Georgios	MF	3				0/1			1	1		
7	TSIKOS Zisis	MF	3	1			0/1		8	1	1		
8	GKOLFINOS Alexios	FW	3						1				
9	SPYRAKOS Nikolaos	MF	3				1/1		7	2			
10	KOUTSIAS Georgios	FW	3		2		6/7		1	8			
11	VOLAKIS Konstantinos	MF	3		1		1/1						
12	MONASTIRLIS Dimitrios	GK	3										
14	GEORGIADIS Charalampos	DF	3				1/1		1	2			
15	PRODROMITIS Athanasios	DF	3	1					4	5	1		
16	SYMEONIDIS Anastasios	MF	3						4	2			
17	SMYRLIS Lampros	MF	3				1/1		2	5			
18	GKITERSOS Ioannis	FW	3	1			1/2		6	3			
19	FILON Marios Taxiarchis	DF	3						3	5			
<b>Totals</b>				3	3	6	12/18	0/0	55	44	4		

Corner Kicks: 5  
 Penalty Kicks Against (Goal/Shots): 0/0  
 Own Goals: 0  
 Own Goals Against: 0

### LEGEND

<b>2Y=R</b> 2nd Yellow = Red Card	<b>AET</b> After Extra Time	<b>AS</b> Assists	<b>DF</b> Defender
<b>FC</b> Fouls Committed	<b>FS</b> Fouls Suffered	<b>FW</b> Forward	<b>GA</b> Goals Against
<b>GF</b> Goals for	<b>GK</b> Goalkeeper	<b>I</b> Injured	<b>MF</b> Midfielder
<b>Min</b> Minutes Played	<b>GK</b> Not eligible to play	<b>No.</b> Number	<b>No.</b> Shirt Number
<b>PK</b> Penalty Kicks (Goals/Shots)	<b>Pos</b> Position	<b>PSO</b> Penalty Shoot-out	<b>R</b> Red Cards (Expulsions)
<b>S</b> Substitute	<b>SG/S</b> Shots on Goal/Shots	<b>Y</b> Yellow Card	
-	-	-	
-	-	-	



## Cumulative Statistics

As of MON 4 JUL 2022 at 23:30

ITA - Italy

Including Game 16

No.	Name	Pos.	MP	AS	GF	GA	SG/S	PK	Fouls		Y	Red Cards	
									FC	FS		2Y=R	R
1	MASTRANTONIO Davide	GK	5			2							
2	MISSORI Filippo	DF	5						2	7			
3	REGONESI Iacopo	DF	5				1/1		6	6			
4	PALELLA Andrea	MF	5						3	8			
5	DELLAVALLE Lorenzo	DF	5						2	5			
6	INDRAGOLI Gabriele	DF	5						2	2			
7	HASA Luis	MF	5				2/6		1	12			
8	KUMI Justin	MF	5				1/3		6	2	1		
9	MANCINI Tommaso	FW	5	1			1/2		6	5			
10	ACCORNERO Federico	MF	5				2/7		5	2			
11	PATANE' Nicola	MF	5						4	2	1		
12	BAGNOLINI Nicola	GK	5										
13	BOZZOLAN Andrea	DF	5				0/1		5	3	1		
14	GUARINO Gabriele	DF	5				0/1		8	1			
15	AMATUCCI Lorenzo	MF	5				0/2		12	5			
16	IGNACCHITI Lorenzo	MF	5				0/2		9	3			
17	D'ANDREA Luca	FW	5		1		3/10	1/1	3	4	1		
18	RAIMONDO Antonio	FW	5		6		8/10	1/1	5	7	1		
<b>Totals</b>				1	7	2	18/45	2/2	79	74	5		

Corner Kicks: 25  
 Penalty Kicks Against (Goal/Shots): 2/2  
 Own Goals: 0  
 Own Goals Against: 0

### LEGEND

<b>2Y=R</b> 2nd Yellow = Red Card	<b>AET</b> After Extra Time	<b>AS</b> Assists	<b>DF</b> Defender
<b>FC</b> Fouls Committed	<b>FS</b> Fouls Suffered	<b>FW</b> Forward	<b>GA</b> Goals Against
<b>GF</b> Goals for	<b>GK</b> Goalkeeper	<b>I</b> Injured	<b>MF</b> Midfielder
<b>Min</b> Minutes Played	<b>GK</b> Not eligible to play	<b>No.</b> Number	<b>No.</b> Shirt Number
<b>PK</b> Penalty Kicks (Goals/Shots)	<b>Pos</b> Position	<b>PSO</b> Penalty Shoot-out	<b>R</b> Red Cards (Expulsions)
<b>S</b> Substitute	<b>SG/S</b> Shots on Goal/Shots	<b>Y</b> Yellow Card	
-	-	-	
-	-	-	



## Cumulative Statistics

As of MON 4 JUL 2022 at 23:30

MAR - Morocco

Including Game 16

No.	Name	Pos.	MP	AS	GF	GA	SG/S	PK	Fouls		Y	Red Cards	
									FC	FS		2Y=R	R
1	MAGO Elias		5			3				1	1		
2	LANTAKI Wassim		5	1					4	1			
3	AKHARRAZ Youness		5						1		1		
4	AMMAL Abdessamad		4				0/1		2	4	2		
5	EL HAMMAMI Ayoub		5				0/1		5	2			
6	BAALLAL Abdellah		5				1/2		1	4			
7	LYAKOUBI Oussama		5				0/5		1	4	1		
8	JAZOULI Mohammed Younes		5				2/3		8	5			
9	SADIK Omar		5		1		6/8		9	2	1		
10	ARHOUN Usama		4				0/2		5	2	3		
11	MAURER Aiman		5		1		4/7		7	9	1		
12	HASBI Walid		5			3							
13	KHATIR Ahmed		5						1	1			
14	ANHARI Hamza		5	2	1		3/3		7	6			
15	BOUKHRES Othmane		5		1		1/1		1	1			
16	TAMOUNE Anouar Khalid		5								2		
17	RAIHANI Abdellah		5		2		3/3		3	2	3		
18	KHALIFI Yassine		5		2		4/8	2/2	6	13	1		
<b>Totals</b>				3	8	6	24/44	2/2	61	57	16		

Corner Kicks: 18  
Penalty Kicks Against (Goal/Shots): 2/2  
Own Goals: 0  
Own Goals Against: 0

### LEGEND

<b>2Y=R</b> 2nd Yellow = Red Card	<b>AET</b> After Extra Time	<b>AS</b> Assists	<b>DF</b> Defender
<b>FC</b> Fouls Committed	<b>FS</b> Fouls Suffered	<b>FW</b> Forward	<b>GA</b> Goals Against
<b>GF</b> Goals for	<b>GK</b> Goalkeeper	<b>I</b> Injured	<b>MF</b> Midfielder
<b>Min</b> Minutes Played	<b>GK</b> Not eligible to play	<b>No.</b> Number	<b>No.</b> Shirt Number
<b>PK</b> Penalty Kicks (Goals/Shots)	<b>Pos</b> Position	<b>PSO</b> Penalty Shoot-out	<b>R</b> Red Cards (Expulsions)
<b>S</b> Substitute	<b>SG/S</b> Shots on Goal/Shots	<b>Y</b> Yellow Card	
-	-	-	-
-	-	-	-



## Cumulative Statistics

As of MON 4 JUL 2022 at 23:30

POR - Portugal

Including Game 16

No.	Name	Pos.	MP	AS	GF	GA	SG/S	PK	Fouls		Y	Red Cards	
									FC	FS		2Y=R	R
1	CARAPINHA CARVALHO Joao G	GK	3			1							
2	PARREIRA PARENTE Tiago	DF	3										
3	DA SILVA OLIVEIRA Hugo	DF	3							1			
4	DA COSTA BRAS Gabriel	DF	3				0/1			3			
5	OLIVEIRA MONTEIRO David Alex	DF	3				1/1		6	4			
6	VILELA GAMA Joao Dinis	MF	3				0/1		1	4			
7	NOBREGA MARQUES Ricardo Mi	FW	3				3/7		4	5			
8	FELIX SEQUEIRA Hugo	MF	3				3/11		3	8	1		
9	BUCANCIL NABIAN Herculano	FW	3						4	3			
10	SOUSA CRUZ Marco	MF	3				0/3		3	3			
11	MONTEIRO MEIRELES Jorge	FW	3				3/4	0/1	3	5			
12	AZEVEDO RIBEIRO Goncalo Mig	GK	3			2							
13	PINHEIRO MONTEIRO Diogo	DF	3				1/3			1			
14	ALMEIDA MACEDO Jose Pedro	DF	3				2/2		8	4			
15	ALVES DE FREITAS Gustavo Filip	MF	3		1		2/5	1/1	11	15			
16	AGUIAR GOMES Bernardo Martim	MF	3				1/1		3	1			
17	RODRIGUES CARVALHO Lucas	FW	3				4/8		3	3			
18	MARIANO FALE Miguel Maria	FW	3		1		2/4		2	2			
<b>Totals</b>					2	3	22/51	1/2	51	62	1		

Corner Kicks: 13  
 Penalty Kicks Against (Goal/Shots): 1/2  
 Own Goals: 0  
 Own Goals Against: 0

### LEGEND

<b>2Y=R</b> 2nd Yellow = Red Card	<b>AET</b> After Extra Time	<b>AS</b> Assists	<b>DF</b> Defender
<b>FC</b> Fouls Committed	<b>FS</b> Fouls Suffered	<b>FW</b> Forward	<b>GA</b> Goals Against
<b>GF</b> Goals for	<b>GK</b> Goalkeeper	<b>I</b> Injured	<b>MF</b> Midfielder
<b>Min</b> Minutes Played	<b>GK</b> Not eligible to play	<b>No.</b> Number	<b>No.</b> Shirt Number
<b>PK</b> Penalty Kicks (Goals/Shots)	<b>Pos</b> Position	<b>PSO</b> Penalty Shoot-out	<b>R</b> Red Cards (Expulsions)
<b>S</b> Substitute	<b>SG/S</b> Shots on Goal/Shots	<b>Y</b> Yellow Card	
-	-	-	
-	-	-	



## Cumulative Statistics

As of MON 4 JUL 2022 at 23:30

TUR - Turkiye

Including Game 16

No.	Name	Pos.	MP	AS	GF	GA	SG/S	PK	Fouls		Y	Red Cards	
									FC	FS		2Y=R	R
1	YILMAZ Jankat	GK	5			8				2			
2	TUNALI Eren	DF	5						2	6	1		
3	TINTIS Emir	DF	5	1			1/2		5	4	1		
4	KAVAS Yasar	DF	5				1/1		4	5			
5	YILMAZ Ali Sahin	DF	5		1		2/5		9	8	1		
6	SATILMIS Sami	MF	5				1/2		9	7	1		
7	BICER Habib	FW	5		3		7/9		5	4			
8	GUNDUZ Teoman	MF	5				1/2		2	1	1		
9	KARADENIR Ahmed	FW	5				1/2		10	6			
10	SENYURT Devran	MF	5				1/4		6	1	1		
11	BUYUKSAYAR Mehmet Ali	MF	5				0/3		3	3			
12	SERHAT Oztasdelen	GK	5			1							
13	MEHMET ENES Gulalan	DF	5						1		1	1	
14	ORTAKAYA Emir	DF	5				1/2		3	1	1		
15	KABASAKAL Ulusoy Mert	MF	5				1/1		3	1	1		
16	KEFELI Yunus Emre	FW	5				2/4		9		2		
17	PINARCI Muhammed Mustafa	MF	5	1			1/1		2	4			
18	KILIC Ali	FW	5				1/4		4	4			
<b>Totals</b>				2	4	9	21/42	0/0	77	57	11		1

Corner Kicks: 21  
Penalty Kicks Against (Goal/Shots): 0/0  
Own Goals: 0  
Own Goals Against: 0

### LEGEND

<b>2Y=R</b> 2nd Yellow = Red Card	<b>AET</b> After Extra Time	<b>AS</b> Assists	<b>DF</b> Defender
<b>FC</b> Fouls Committed	<b>FS</b> Fouls Suffered	<b>FW</b> Forward	<b>GA</b> Goals Against
<b>GF</b> Goals for	<b>GK</b> Goalkeeper	<b>I</b> Injured	<b>MF</b> Midfielder
<b>Min</b> Minutes Played	<b>GK</b> Not eligible to play	<b>No.</b> Number	<b>No.</b> Shirt Number
<b>PK</b> Penalty Kicks (Goals/Shots)	<b>Pos</b> Position	<b>PSO</b> Penalty Shoot-out	<b>R</b> Red Cards (Expulsions)
<b>S</b> Substitute	<b>SG/S</b> Shots on Goal/Shots	<b>Y</b> Yellow Card	
-	-	-	
-	-	-	



## Overall Team Statistics

As of MON 4 JUL 2022 at 23:31

Team	MP	AS	GF	GA	SG/S	PK	PKA	CK	Fouls		Y	Red Cards		
									FC/Avg	FS/Avg		2Y=R	R	
ALG	3	1	3	5	14/32	1/1	1/1	13	33/11.0	54/18.0	8	1		
ESP	3		2	3	18/43	0/0	1/1	11	35/11.7	34/11.3	5			
FRA	5	1	8	3	24/38	2/2	1/1	17	67/13.4	61/12.2	8			
GRE	3	3	3	6	12/18	0/0	2/2	5	55/18.3	44/14.7	4			
ITA	5	1	7	2	18/45	2/2	1/2	25	79/15.8	74/14.8	5			
MAR	5	3	8	6	24/44	2/2	1/1	18	61/12.2	57/11.4	16			
POR	3		2	3	22/51	1/2	0/0	13	51/17.0	62/20.7	1			
TUR	5	2	4	9	21/42	0/0	1/1	21	77/15.4	57/11.4	11	1		
Tournament	<b>Totals</b>		11	37	37	153/313	8/9	8/9	123	458/28.6	443/27.7	58	2	
	<b>Average (Per Match)</b>		0.7	2.3	2.3	9.6/19.6	0.5/0.6	0.5/0.6	7.7	28.6/28.6	27.7/27.7	3.6	0.1	0.0

### LEGEND

<b>2Y=R</b> 2nd Yellow = Red Card	<b>AS</b> Assists	<b>AVG</b> Average per Match	<b>CK</b> Corner kick
<b>FC</b> Fouls Committed	<b>FS</b> Fouls Suffered	<b>GA</b> Goals Against	<b>GF</b> Goals for
<b>MP</b> Matches Played	<b>PK</b> Penalty Kicks (Goals/Shots)	<b>PKA</b> Penalty Kicks Against (Goals/Shots)	<b>R</b> Red Cards (Expulsions)
<b>SG/S</b> Shots on Goal/Shots	<b>Y</b> Yellow Card	-	-
-	-	-	-





## Individual Statistics

As of MON 4 JUL 2022 at 23:31

### GOALSCORERS

Rank	Shirt No.	Name	Team	MP	Goals
1	18	RAIMONDO Antonio	ITA	5	6
2	17	MESSOUSSA Amine Abdelrahmane	FRA	5	4
3	7	BICER Habib	TUR	5	3
4	10	KOUTSIAS Georgios	GRE	3	2
5	17	RAIHANI Abdellah	MAR	5	2
5	18	KHALIFI Yassine	MAR	5	2
5	18	IKIA DIMI Yvan Junior	FRA	5	2
8	2	ZAOUI Salah Eddine	ALG	3	1
8	8	PUCH-HERRANTZ Mehdi Guillermo Moh	ALG	3	1
8	9	CHEGRA Ivane	ALG	3	1
8	11	VOLAKIS Konstantinos	GRE	3	1
8	12	RODRIGUEZ MUNOZ Alvaro Daniel	ESP	3	1
8	15	ALVES DE FREITAS Gustavo Filipe	POR	3	1
8	16	VALLE GOMEZ Alex	ESP	3	1
8	18	MARIANO FALE Miguel Maria	POR	3	1
16	7	PIRRINGUEL Lenny Seive	FRA	4	1
17	5	YILMAZ Ali Sahin	TUR	5	1
17	9	SADIK Omar	MAR	5	1
17	11	MAURER Aiman	MAR	5	1
17	14	ANHARI Hamza	MAR	5	1
17	15	BOUKHRES Othmane	MAR	5	1
17	15	BOUANANI Badredine	FRA	5	1
17	17	D'ANDREA Luca	ITA	5	1

### SHOTS ON GOAL

Rank	Shirt No.	Name	Team	MP	SG	AVG
1	15	BOUANANI Badredine	FRA	5	8	1.6
1	18	RAIMONDO Antonio	ITA	5	8	1.6
3	7	BICER Habib	TUR	5	7	1.4
4	10	KOUTSIAS Georgios	GRE	3	6	2.0
5	9	SADIK Omar	MAR	5	6	1.2
5	17	MESSOUSSA Amine Abdelrahman	FRA	5	6	1.2
7	7	BLANCO GOMEZ Fabio	ESP	3	4	1.3
7	17	RODRIGUES CARVALHO Lucas	POR	3	4	1.3
9	11	MAURER Aiman	MAR	5	4	0.8
9	18	KHALIFI Yassine	MAR	5	4	0.8
9	18	IKIA DIMI Yvan Junior	FRA	5	4	0.8
12	7	NOBREGA MARQUES Ricardo Mi	POR	3	3	1.0
12	8	FELIX SEQUEIRA Hugo	POR	3	3	1.0
12	9	CHEGRA Ivane	ALG	3	3	1.0
12	10	OMAR Mohamed Rafik	ALG	3	3	1.0
12	11	MONTEIRO MEIRELES Jorge	POR	3	3	1.0
12	16	VALLE GOMEZ Alex	ESP	3	3	1.0
18	7	PIRRINGUEL Lenny Seive	FRA	4	3	0.8
19	14	ANHARI Hamza	MAR	5	3	0.6



## Individual Statistics

As of MON 4 JUL 2022 at 23:31

Rank	Shirt No.	Name	Team	MP	SG	AVG
19	17	RAIHANI Abdellah	MAR	5	3	0.6
19	17	D'ANDREA Luca	ITA	5	3	0.6
22	6	MARTINEZ SANTAMARIA Roger	ESP	3	2	0.7
22	9	DENIA DIAZ Marcos	ESP	3	2	0.7
22	14	ALMEIDA MACEDO Jose Pedro	POR	3	2	0.7
22	15	ALVES DE FREITAS Gustavo Filip	POR	3	2	0.7
22	17	GHARBI ALVAREZ Ismael	ESP	3	2	0.7
22	18	BEN MAZOUZ Mohamed Said	ALG	3	2	0.7
22	18	MARIANO FALE Miguel Maria	POR	3	2	0.7
29	5	YILMAZ Ali Sahin	TUR	5	2	0.4
29	7	HASA Luis	ITA	5	2	0.4
29	8	JAZOULI Mohammed Younes	MAR	5	2	0.4
29	10	ACCORNERO Federico	ITA	5	2	0.4
29	16	KEFELI Yunus Emre	TUR	5	2	0.4
34	2	ALEMAN CASTILLO Carlos	ESP	3	1	0.3
34	2	ZAOUI Salah Eddine	ALG	3	1	0.3
34	4	BOUNACER Abdessamed	ALG	3	1	0.3
34	4	KERAMITSIS Dimitrios	GRE	3	1	0.3
34	5	OLIVEIRA MONTEIRO David Alexa	POR	3	1	0.3
34	7	ZULLIANI Edhy Yvan	ALG	3	1	0.3
34	8	PUCH-HERRANTZ Mehdi Guillem	ALG	3	1	0.3
34	8	MORAN IBANEZ Manuel Angel	ESP	3	1	0.3
34	9	SPYRAKOS Nikolaos	GRE	3	1	0.3
34	10	GUERRERO LANDABASO Julen J	ESP	3	1	0.3
34	11	DOUGUI Adam	ALG	3	1	0.3
34	11	VOLAKIS Konstantinos	GRE	3	1	0.3
34	12	RODRIGUEZ MUNOZ Alvaro Dani	ESP	3	1	0.3
34	13	PINHEIRO MONTEIRO Diogo	POR	3	1	0.3
34	14	BASTIDA MOYA Alvaro	ESP	3	1	0.3
34	14	GEORGIADIS Charalampos	GRE	3	1	0.3
34	15	AKHRIB Lahlou	ALG	3	1	0.3
34	16	AGUIAR GOMES Bernardo Martim	POR	3	1	0.3
34	17	SMYRLIS Lampros	GRE	3	1	0.3
34	18	GKITEROS Ioannis	GRE	3	1	0.3
54	3	TINTIS Emir	TUR	5	1	0.2
54	3	REGONESI Iacopo	ITA	5	1	0.2
54	4	KAVAS Yasar	TUR	5	1	0.2
54	6	SATILMIS Sami	TUR	5	1	0.2
54	6	BAALLAL Abdellah	MAR	5	1	0.2
54	8	GUNDUZ Teoman	TUR	5	1	0.2
54	8	KUMI Justin	ITA	5	1	0.2
54	9	MANCINI Tommaso	ITA	5	1	0.2
54	9	KANOUTE Mahamadou	FRA	5	1	0.2
54	9	KARADENIR Ahmed	TUR	5	1	0.2
54	10	SENYURT Devran	TUR	5	1	0.2
54	11	BACAHHA Mohamed Adel	FRA	5	1	0.2



## Individual Statistics

As of MON 4 JUL 2022 at 23:31

Rank	Shirt No.	Name	Team	MP	SG	AVG
54	12	BOLUMBU SOMBO Diabe Ousma	FRA	5	1	0.2
54	14	ORTAKAYA Emir	TUR	5	1	0.2
54	15	KABASAKAL Ulusoy Mert	TUR	5	1	0.2
54	15	BOUKHRES Othmane	MAR	5	1	0.2
54	17	PINARCI Muhammed Mustafa	TUR	5	1	0.2
54	18	KILIC Ali	TUR	5	1	0.2

## SHOTS

Rank	Shirt No.	Name	Team	MP	S	AVG
1	8	FELIX SEQUEIRA Hugo	POR	3	11	3.7
2	15	BOUANANI Badredine	FRA	5	11	2.2
3	17	D'ANDREA Luca	ITA	5	10	2.0
3	18	RAIMONDO Antonio	ITA	5	10	2.0
5	7	BICER Habib	TUR	5	9	1.8
5	17	MESSOUSSA Amine Abdelrahman	FRA	5	9	1.8
7	9	CHEGRA Ivane	ALG	3	8	2.7
7	17	RODRIGUES CARVALHO Lucas	POR	3	8	2.7
9	9	SADIK Omar	MAR	5	8	1.6
9	18	KHALIFI Yassine	MAR	5	8	1.6
11	7	NOBREGA MARQUES Ricardo Mi	POR	3	7	2.3
11	10	KOUTSIAS Georgios	GRE	3	7	2.3
13	10	ACCORNERO Federico	ITA	5	7	1.4
13	11	MAURER Aiman	MAR	5	7	1.4
15	7	BLANCO GOMEZ Fabio	ESP	3	6	2.0
15	8	MORAN IBANEZ Manuel Angel	ESP	3	6	2.0
15	10	OMAR Mohamed Rafik	ALG	3	6	2.0
18	7	HASA Luis	ITA	5	6	1.2
19	10	GUERRERO LANDABASO Julen J	ESP	3	5	1.7
19	15	ALVES DE FREITAS Gustavo Filip	POR	3	5	1.7
21	5	YILMAZ Ali Sahin	TUR	5	5	1.0
21	7	LYAKOUBI Oussama	MAR	5	5	1.0
23	8	PUCH-HERRANTZ Mehdi Guillem	ALG	3	4	1.3
23	11	EL JEBARI Salim	ESP	3	4	1.3
23	11	MONTEIRO MEIRELES Jorge	POR	3	4	1.3
23	12	RODRIGUEZ MUNOZ Alvaro Dani	ESP	3	4	1.3
23	17	GHARBI ALVAREZ Ismael	ESP	3	4	1.3
23	18	BEN MAZOUZ Mohamed Said	ALG	3	4	1.3
23	18	MARIANO FALE Miguel Maria	POR	3	4	1.3
30	10	SENYURT Devran	TUR	5	4	0.8
30	16	KEFELI Yunus Emre	TUR	5	4	0.8
30	18	KILIC Ali	TUR	5	4	0.8
30	18	IKIA DIMI Yvan Junior	FRA	5	4	0.8
34	6	MARTINEZ SANTAMARIA Roger	ESP	3	3	1.0
34	7	ZULLIANI Edhy Yvan	ALG	3	3	1.0
34	9	DENIA DIAZ Marcos	ESP	3	3	1.0
34	10	SOUSA CRUZ Marco	POR	3	3	1.0



## Individual Statistics

As of MON 4 JUL 2022 at 23:31

Rank	Shirt No.	Name	Team	MP	S	AVG
34	13	PINHEIRO MONTEIRO Diogo	POR	3	3	1.0
34	14	BASTIDA MOYA Alvaro	ESP	3	3	1.0
34	16	VALLE GOMEZ Alex	ESP	3	3	1.0
41	7	PIRRINGUEL Lenny Seive	FRA	4	3	0.8
42	8	DOUMBIA Cheick Mohamed	FRA	5	3	0.6
42	8	KUMI Justin	ITA	5	3	0.6
42	8	JAZOULI Mohammed Younes	MAR	5	3	0.6
42	11	BUYUKSAYAR Mehmet Ali	TUR	5	3	0.6
42	11	BACAHA Mohamed Adel	FRA	5	3	0.6
42	14	ANHARI Hamza	MAR	5	3	0.6
42	17	RAIHANI Abdellah	MAR	5	3	0.6
49	4	BOUNACER Abdessamed	ALG	3	2	0.7
49	4	KERAMITSIS Dimitrios	GRE	3	2	0.7
49	11	DOUGUI Adam	ALG	3	2	0.7
49	14	ALMEIDA MACEDO Jose Pedro	POR	3	2	0.7
49	18	GKITEROS Ioannis	GRE	3	2	0.7
54	10	ARHOUN Usama	MAR	4	2	0.5
55	3	TINTIS Emir	TUR	5	2	0.4
55	6	SATILMIS Sami	TUR	5	2	0.4
55	6	BAALLAL Abdellah	MAR	5	2	0.4
55	8	GUNDUZ Teoman	TUR	5	2	0.4
55	9	KARADENIR Ahmed	TUR	5	2	0.4
55	9	MANCINI Tommaso	ITA	5	2	0.4
55	14	ORTAKAYA Emir	TUR	5	2	0.4
55	15	AMATUCCI Lorenzo	ITA	5	2	0.4
55	16	IGNACCHITI Lorenzo	ITA	5	2	0.4
64	2	ZAOUI Salah Eddine	ALG	3	1	0.3
64	2	ALEMAN CASTILLO Carlos	ESP	3	1	0.3
64	4	DA COSTA BRAS Gabriel	POR	3	1	0.3
64	5	OLIVEIRA MONTEIRO David Alexa	POR	3	1	0.3
64	5	CHRISTOU Nikolaos	GRE	3	1	0.3
64	6	KYRIOPOULOS Georgios	GRE	3	1	0.3
64	6	VILELA GAMA Joao Dinis	POR	3	1	0.3
64	7	TSIKOS Zisis	GRE	3	1	0.3
64	9	SPYRAKOS Nikolaos	GRE	3	1	0.3
64	11	VOLAKIS Konstantinos	GRE	3	1	0.3
64	14	GEORGIADIS Charalampos	GRE	3	1	0.3
64	14	NOTTEBAERE Djibril	ALG	3	1	0.3
64	15	AKHRIB Lahlou	ALG	3	1	0.3
64	16	AGUIAR GOMES Bernardo Martim	POR	3	1	0.3
64	17	SMYRLIS Lampros	GRE	3	1	0.3
64	18	PUJOL PORTORREAL Edgar Clim	ESP	3	1	0.3
80	4	AMMAL Abdessamad	MAR	4	1	0.3
81	2	LOUIS-JEAN Johaneke Henri	FRA	5	1	0.2
81	3	REGONESI Iacopo	ITA	5	1	0.2
81	4	KAVAS Yasar	TUR	5	1	0.2



## Individual Statistics

As of MON 4 JUL 2022 at 23:31

Rank	Shirt No.	Name	Team	MP	S	AVG
81	4	MERCIER Kevin Mathis	FRA	5	1	0.2
81	5	EL HAMMAMI Ayoub	MAR	5	1	0.2
81	5	CHIESA Ange	FRA	5	1	0.2
81	9	KANOUTE Mahamadou	FRA	5	1	0.2
81	12	BOLUMBU SOMBO Diabe Ousma	FRA	5	1	0.2
81	13	BOZZOLAN Andrea	ITA	5	1	0.2
81	14	GUARINO Gabriele	ITA	5	1	0.2
81	15	KABASAKAL Ulusoy Mert	TUR	5	1	0.2
81	15	BOUKHRES Othmane	MAR	5	1	0.2
81	17	PINARCI Muhammed Mustafa	TUR	5	1	0.2

### LEGEND

AVG Average per Match

MP Matches Played

S Shots

SG Shots on Goal



ألعاب البحر الأبيض المتوسط  
MEDITERRANEAN GAMES  
JEUX MÉDITERRANÉENS  
du 25 juin au 06 juillet

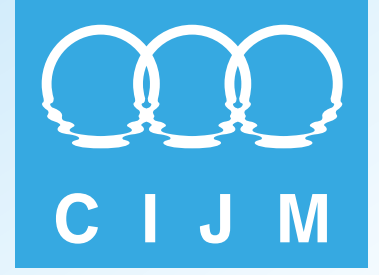

# Results Book



## Fencing



**TOSYALI  
ALGERIE**

Fer et Acier

سوناطراي



sonarach



microplus  
DATA PROCESSING & TIMING  
[www.microplustiming.com](http://www.microplustiming.com)



## Number of Entries by Country

As of TUE 5 JUL 2022

Country	Entries by Event						Number of Athletes		
	Men			Women			Men	Women	Total
	EI	FI	SI	EI	FI	SI			
ALG	3	3	3	3	3	3	9	9	18
CRO		1					1	0	1
CYP	1	1		1			2	1	3
EGY	3	3	3				9	0	9
ESP	1	1	1	1	2	2	3	5	8
FRA	3	3	3	3	3	3	9	9	18
ITA	3	3	3	3	3	3	9	9	18
LBA	3						3	0	3
LBN	1			1	1		1	1	2
MAR	3						3	0	3
MKD	1			1			1	1	2
POR	2	1			1		3	1	4
SLO			2				2	0	2
SRB		1		1			1	1	2
TUN			3	1		1	3	2	5
TUR	1	1	1	2	2	3	3	7	10
<b>Total: 16</b>	<b>25</b>	<b>18</b>	<b>19</b>	<b>17</b>	<b>15</b>	<b>15</b>	<b>62</b>	<b>46</b>	<b>108</b>

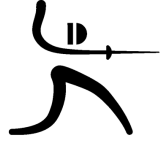

## Medallists by event

As of TUE 5 JUL 2022 at 21:58

After 6 of 6 events

Event	Date	Medal	Name	CTRY Code
Women Épée Individual	MON 4 JUL 2022	GOLD	RIZZI Giulia	ITA
		SILVER	FOIETTA Nicol	ITA
		BRONZE	MARZANI Roberta	ITA
		BRONZE	VANRYSEL Eloise	FRA
Women Foil Individual	TUE 5 JUL 2022	GOLD	CALISSI Olqa Rachele	ITA
		SILVER	PATRU Morgane	FRA
		BRONZE	DIAZ ESCALONA Maria Teresa	ESP
		BRONZE	KARAME TE Irem	TUR
Women Sabre Individual	SUN 3 JUL 2022	GOLD	BOUDI AF Saoussen Dlindah	ALG
		SILVER	MORMILE Chiara	ITA
		BRONZE	GARGANO Rebecca	ITA
		BRONZE	PASSARO Eloisa	ITA
Men Épée Individual	MON 4 JUL 2022	GOLD	ELSAYED Mohamed	EGY
		SILVER	CUOMO Valerio	ITA
		BRONZE	PAOLINI Giacomo	ITA
		BRONZE	TAGLIARIOL Matteo	ITA
Men Foil Individual	TUE 5 JUL 2022	GOLD	CUK Veliko	SRB
		SILVER	LLAVADOR Carlos	ESP
		BRONZE	FILIPPI Davide	ITA
		BRONZE	HAMZA Mohamed	EGY
Men Sabre Individual	SUN 3 JUL 2022	GOLD	ELSISSY Ziad	EGY
		SILVER	NUCCIO Riccardo	ITA
		BRONZE	BRAVO ARAMBURU Inaki	ESP
		BRONZE	CAVALIERE Dario	ITA



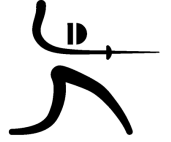

## Medal Standings

As of TUE 5 JUL 2022 at 22:01

After 6 of 6 events

Rank	Country	Men				Women				Team				Total				Rank by total
		G	S	B	Tot	G	S	B	Tot	G	S	B	Tot	G	S	B	Tot	
1	ITA - Italy		2	4	6	2	2	3	7					2	4	7	13	1
2	EGY - Egypt	2		1	3									2		1	3	= 2
3	ALG - Algeria					1			1					1			1	= 5
3	SRB - Serbia	1			1									1			1	= 5
5	ESP - Spain		1	1	2			1	1						1	2	3	= 2
6	FRA - France						1	1	2						1	1	2	4
7	TUR - Turkiye							1	1							1	1	= 5
	<b>Total:</b>	<b>3</b>	<b>3</b>	<b>6</b>	<b>12</b>	<b>3</b>	<b>3</b>	<b>6</b>	<b>12</b>					<b>6</b>	<b>6</b>	<b>12</b>	<b>24</b>	

### LEGEND

= Equal indicates the same rank  
Tot Total

B Bronze

G Gold

S Silver

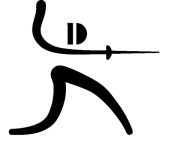

## Medallists

As of MON 4 JUL 2022 at 19:18

Medal	Name	CTRY
GOLD	ELSAYED Mohamed	EGY - Egypt
SILVER	CUOMO Valerio	ITA - Italy
BRONZE	PAOLINI Giacomo	ITA - Italy
BRONZE	TAGLIARIOL Matteo	ITA - Italy

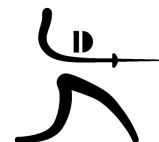

## Entry List by event

As of SAT 2 JUL 2022

CTRY	Name	Date of Birth	Handedness
ALG - Algeria	BENRE GUIA Menaouer	25 MAY 1996	Right
	HOAREAU-BERKANI Raphael Jacques	29 JUN 2002	
	KRARIA Mohamed Cherif	7 MAR 2004	
CYP - Cyprus	TALIOTIS Alexandros	23 JAN 2018	Right
EGY - Egypt	ELSAIED Mohamed	3 MAR 2002	
	ELSOKKARY Ahmad Ashraf	16 DEC 1997	
	YASSEEN Mohammed	5 JAN 2004	
ESP - Spain	FABREGAT PUJOL Angel	10 DEC 1996	Right
FRA - France	ALLEGRE Paul	2 JUN 1996	Right
	FAVA Alex	29 APR 1989	Right
	JERENT Daniel	4 JUN 1991	Right
ITA - Italy	CUOMO Valerio	18 APR 1998	Right
	PAOLINI Giacomo	20 JUL 1998	Right
	TAGLIARIOL Matteo	7 JAN 1983	Right
LBA - Libya	ABUJTELA Abdussalam	2 AUG 2000	Left
	ALGADI Abubaker	28 AUG 2002	Left
	ELJIBALI Mohamed	2 MAY 2001	Right
LBN - Lebanon	EL CHOUEIRI Antoine	26 FEB 1999	
MAR - Morocco	EL HAOUARI Abdelkarim	19 DEC 1993	
	ELKORD Houssam	24 FEB 1993	
	NAHI Omar	28 SEP 1993	
MKD - Rep. of North Mace	SRBINOSKI Petar	13 JUL 2004	
POR - Portugal	FRAZAO Filipe	31 MAR 2001	Right
	FRAZAO Miguel	25 JUL 2002	Right
TUR - Turkiye	EKENLER Hilmi Taha	7 DEC 2001	

Total number of fencers: 25



## Pool Results

### Pool No: 1 Piste No: 2 Time: 08:30

#	NAME	CTRY	a	b	c	d	e	f	g	V#	M#	Ind.	TG	TR	Diff.	Rk
1	PAOLINI Giacomo	ITA	---	4	V	V	V	V	V	5	6	0.833	29	9	20	1
1	ELSAYED Mohamed	EGY	V	---	4	V	V	V	V	5	6	0.833	29	14	15	2
1	FRAZAO Miguel	POR	0	V	---	V	V	V	4	4	6	0.666	24	20	4	3
1	HOAREAU-BERKANI Raphael Jac	ALG	1	2	0	---	V	V4	V	3	6	0.500	17	23	-6	4
1	SRBINOSKI Petar	MKD	0	2	2	3	---	V	V	2	6	0.333	17	26	-9	5
1	ABUJTELA Abdussalam	LBA	2	1	4	3	3	---	V	1	6	0.166	18	28	-10	6
1	NAHI Omar	MAR	1	0	V	2	3	4	---	1	6	0.166	15	29	-14	7

### Pool No: 2 Piste No: 3 Time: 08:40

#	NAME	CTRY	a	b	c	d	e	f	V#	M#	Ind.	TG	TR	Diff.	Rk
1	TAGLIARIOL Matteo	ITA	---	V4	V	V	V	V3	5	5	1.000	22	13	9	1
1	JERENT Daniel	FRA	3	---	V	V	V	V4	4	5	0.800	22	14	8	2
1	ELSOKKARY Ahmad Ashraf	EGY	2	3	---	V	V	V	3	5	0.600	20	15	5	3
1	ELKORD Houssam	MAR	4	1	3	---	V	V	2	5	0.400	18	17	1	4
1	EL CHOUERI Antoine	LBN	2	3	2	2	---	V	1	5	0.200	14	22	-8	5
1	ELJIBALI Mohamed	LBA	2	3	0	0	2	---	0	5	0.000	7	22	-15	6

### Pool No: 3 Piste No: 4 Time: 08:35

#	NAME	CTRY	a	b	c	d	e	f	V#	M#	Ind.	TG	TR	Diff.	Rk
1	YASSEEN Mohammed	EGY	---	0	V4	V	V	V	4	5	0.800	19	8	11	1
1	FAVA Alex	FRA	V1	---	V3	2	V4	V	4	5	0.800	15	8	7	2
1	FRAZAO Filipe	POR	2	1	---	3	V	V	2	5	0.400	16	13	3	3
1	EL HAOUARI Abdelkarim	MAR	1	V3	V	---	4	4	2	5	0.400	17	20	-3	4
1	ALGADI Abubaker	LBA	1	3	0	V	---	V	2	5	0.400	14	19	-5	5
1	BENRE GUIA Menaouer	ALG	3	1	1	V	1	---	1	5	0.200	11	24	-13	6

### Pool No: 4 Piste No: 5 Time: 08:40

#	NAME	CTRY	a	b	c	d	e	f	V#	M#	Ind.	TG	TR	Diff.	Rk
1	CUOMO Valerio	ITA	---	V	V	V	2	V	4	5	0.800	22	12	10	1
1	ALLEGRE Paul	FRA	3	---	2	V	V	V	3	5	0.600	20	15	5	2
1	EKENLER Hilmi Taha	TUR	0	V	---	4	V	V	3	5	0.600	19	20	-1	3
1	TALLOTIS Alexandros	CYP	1	2	V	---	V4	V	3	5	0.600	17	21	-4	4
1	FABREGAT PUJOL Angel	ESP	V	3	4	3	---	2	1	5	0.200	17	21	-4	5
1	KRARIA Mohamed Cherif	ALG	3	0	4	4	V	---	1	5	0.200	16	22	-6	6

#### LEGEND

<b>D</b> Defeat	<b>Diff.</b> Difference TG-TR	<b>DNF</b> Did Not Finish	<b>DNS</b> Did Not Start
<b>EXC</b> Exclusion	<b>Ind.</b> Calculate index (V#/M#)	<b>M#</b> Number of matches	<b>Rk</b> Rank in pool
<b>V#</b> Number of victories	<b>TG</b> Given touches	<b>TR</b> Received touches	<b>V</b> Victory



### Draw

Round of 32	Round of 16	Quarter Final	Semifinals	Gold Medal Match
1 TAGLIARIOL M. ITA	TAGLIARIOL M. ITA	TAGLIARIOL M. ITA	TAGLIARIOL M. ITA	CUOMO V. ITA
BYE	BYE	BYE	BYE	15-10
ALGADI A. LBA	11:30 Piste Blue EL HAOUARI A. MAR	15-7	16:30 Piste Final	15-10
10:50 Piste Blue EL HAOUARI A. MAR	15-12	12:30 Piste Blue	15-5	15-10
9 ALLEGRE P. FRA	ALLEGRE P. FRA	ALLEGRE P. FRA	15-5	15-10
BYE	11:50 Piste Blue	15-11	16:30 Piste Final	15-10
BYE	FRAZAO M. POR	15-11	16:30 Piste Final	15-10
4 FRAZAO M. POR	FRAZAO M. POR	15-11	16:30 Piste Final	15-10
5 CUOMO V. ITA	CUOMO V. ITA	CUOMO V. ITA	16:30 Piste Final	15-10
BYE	11:30 Piste Yellow	15-7	16:30 Piste Final	15-10
BYE	TALIOTIS A. CYP	15-7	16:30 Piste Final	15-10
10 TALIOTIS A. CYP	TALIOTIS A. CYP	15-7	16:30 Piste Final	15-10
HOAREAU-BERKANI ALG	11:50 Piste Yellow	12:30 Piste Yellow	16:30 Piste Final	15-10
10:50 Piste Yellow KRARIA M. ALG	15-11	12-8	16:30 Piste Final	15-10
BYE	YASSEEN M. EGY	15-5	16:30 Piste Final	15-10
3 YASSEEN M. EGY	YASSEEN M. EGY	15-5	16:30 Piste Final	15-10
11 ELSAYED M. EGY	ELSAIED M. EGY	ELSAIED M. EGY	18:00 Piste Final	15-13
BYE	11:30 Piste Green	15-12	18:00 Piste Final	15-13
FABREGAT A. ESP	FABREGAT A. ESP	15-12	18:00 Piste Final	15-13
10:50 Piste Green FRAZAO F. POR	15-11	15-12	18:00 Piste Final	15-13
10 EKENLER H. TUR	EKENLER H. TUR	12:30 Piste Green	18:00 Piste Final	15-13
BYE	11:50 Piste Green	15-5	18:00 Piste Final	15-13
BYE	JERENT D. FRA	15-5	18:00 Piste Final	15-13
5 JERENT D. FRA	JERENT D. FRA	15-5	18:00 Piste Final	15-13
6 FAVA A. FRA	FAVA A. FRA	ELSAIED M. EGY	16:50 Piste Final	15-14
BYE	11:30 Piste Red	11-10	16:50 Piste Final	15-14
BYE	ELSAIED M. EGY	11-10	16:50 Piste Final	15-14
9 ELSOKKARY A. EGY	ELSAIED M. EGY	11-10	16:50 Piste Final	15-14
ELKORD H. MAR	ELKORD H. MAR	12:30 Piste Red	16:50 Piste Final	15-14
10:50 Piste Red SRBINOSKI P. MKD	15-10	15-10	16:50 Piste Final	15-14
BYE	11:50 Piste Red	15-8	16:50 Piste Final	15-14
1 PAOLINI G. ITA	PAOLINI G. ITA	15-8	16:50 Piste Final	15-14
1 PAOLINI G. ITA	PAOLINI G. ITA	15-8	16:50 Piste Final	15-14

GOLD

ELSAIED Mohamed EGY  
15-13

SILVER

CUOMO Valerio ITA

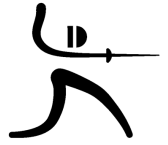

## Standings

As of MON 4 JUL 2022 at 18:44

Rank	Name	Country
Gold	ELSAYED Mohamed	EGY - Egypt
Silver	CUOMO Valerio	ITA - Italy
Bronze	PAOLINI Giacomo	ITA - Italy
Bronze	TAGLIARIOL Matteo	ITA - Italy
5	YASSEEN Mohammed	EGY - Egypt
6	JERENT Daniel	FRA - France
7	ALLEGRE Paul	FRA - France
7	ELSOKKARY Ahmad Ashraf	EGY - Egypt
9	FAVA Alex	FRA - France
10	FRAZAO Miquel	POR - Portugal
11	EKENLER Hilmi Taha	TUR - Turkiye
12	TALIOTIS Alexandros	CYP - Cyprus
13	HOAREAU-BERKANI Raphael Jacques	ALG - Algeria
14	ELKORD Houssam	MAR - Morocco
15	EL HAOUARI Abdelkarim	MAR - Morocco
16	FABREGAT PUJOL Angel	ESP - Spain
17	FRAZAO Filipe	POR - Portugal
18	ALGADI Abubaker	LBA - Libya
19	SRBINOSKI Petar	MKD - Rep. of North Macedonia
20	KRARIA Mohamed Cherif	ALG - Algeria
21	EL CHOUEIRI Antoine	LBN - Lebanon
22	BENRE GUIA Menaouer	ALG - Algeria
23	ABUJTELA Abdussalam	LBA - Libya
24	NAHI Omar	MAR - Morocco
25	ELJIBALI Mohamed	LBA - Libya



Centre MBA - Halle 01 et 02

Fencing

Men's Foil Individual

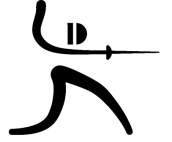

## Medallists

As of TUE 5 JUL 2022 at 20:06

Medal	Name	CTRY
GOLD	CUK Veljko	SRB - Serbia
SILVER	LLAVADOR Carlos	ESP - Spain
BRONZE	FILIPPI Davide	ITA - Italy
BRONZE	HAMZA Mohamed	EGY - Egypt



## Entry List by event

As of SAT 2 JUL 2022

CTRY	Name	Date of Birth	Handedness
ALG - Algeria	FELLAH Dani-Adam	22 SEP 2005	
	HEROUI Salim	19 MAR 1999	
	MADI Youcef	10 APR 1998	
CRO - Croatia	FILES Petar	26 JUL 1997	Right
CYP - Cyprus	TOFALIDES Alex	13 MAR 1993	
EGY - Egypt	ABOELKASEM Alaaeldin	25 NOV 1990	
	ESSAM Mohamed	6 DEC 1994	
	HAMZA Mohamed	11 SEP 2000	
ESP - Spain	LLAVADOR Carlos	26 APR 1992	Left
FRA - France	BIBARD Tyvan	22 MAY 1999	Right
	EDIRI Alexandre	30 JAN 1998	Right
	ELICE Meddy	7 FEB 1996	Left
ITA - Italy	BIANCHI Guillaume	30 JUL 1997	Right
	FILIPPI Davide	14 MAR 1998	Right
	LUPERI Edoardo	9 NOV 1993	Left
POR - Portugal	MACEDO Luis	23 NOV 2000	Left
SRB - Serbia	CUK Veljko	26 JAN 2000	Right
TUR - Turkiye	MINUTO Martino	7 APR 1988	

Total number of fencers: 18





## Pool Results

Pool No: 1 Piste No: 2 Time: 09:10

#	NAME	CTRY	a	b	c	d	e	f	V#	M#	Ind.	TG	TR	Diff.	Rk
1	CUK Veljko	SRB	---	V	V	V	V	V	5	5	1.000	25	15	10	1
1	BIANCHI Guillaume	ITA	2	---	V	3	V	V	3	5	0.600	20	16	4	2
1	TOFALIDES Alex	CYP	3	2	---	V	V	V	3	5	0.600	20	17	3	3
	ABOELKASEM Alaaeldin	EGY	4	V	3	---	4	V	2	5	0.400	21	22	-1	4
1	EDIRI Alexandre	FRA	4	2	3	V	---	V	2	5	0.400	19	22	-3	5
1	HEROUI Salim	ALG	2	2	1	4	3	---	0	5	0.000	12	25	-13	6

Pool No: 2 Piste No: 3 Time: 09:00

#	NAME	CTRY	a	b	c	d	e	f	V#	M#	Ind.	TG	TR	Diff.	Rk
1	FILIPPI Davide	ITA	---	V	V	V	V	V	5	5	1.000	25	14	11	1
1	HAMZA Mohamed	EGY	4	---	V	V	V	V	4	5	0.800	24	14	10	2
1	BIBARD Tyvan	FRA	3	4	---	V	V	V	3	5	0.600	22	17	5	3
1	MINUTO Martino	TUR	3	1	3	---	V	V	2	5	0.400	17	16	1	4
1	MACEDO Luis	POR	3	2	3	1	---	V	1	5	0.200	14	22	-8	5
1	MADI Youcef	ALG	1	2	1	0	2	---	0	5	0.000	6	25	-19	6

Pool No: 3 Piste No: 4 Time: 09:05

#	NAME	CTRY	a	b	c	d	e	f	V#	M#	Ind.	TG	TR	Diff.	Rk
1	LLAVADOR Carlos	ESP	---	V	V	V	V	V	5	5	1.000	25	7	18	1
1	LUPERI Edoardo	ITA	3	---	V	V	V	V	4	5	0.800	23	14	9	2
1	ELICE Meddy	FRA	1	2	---	V	V	V	3	5	0.600	18	17	1	3
1	ESSAM Mohamed	EGY	2	2	4	---	V	V	2	5	0.400	18	20	-2	4
1	FILES Petar	CRO	1	4	1	2	---	V	1	5	0.200	13	22	-9	5
1	FELLAH Dani-Adam	ALG	0	1	2	3	2	---	0	5	0.000	8	25	-17	6

### LEGEND

<b>D</b>	Defeat	<b>Diff.</b>	Difference TG-TR	<b>DNF</b>	Did Not Finish	<b>DNS</b>	Did Not Start
<b>EXC</b>	Exclusion	<b>Ind.</b>	Calculate index (V#/M#)	<b>M#</b>	Number of matches	<b>Rk</b>	Rank in pool
<b>V#</b>	Number of victories	<b>TG</b>	Given touches	<b>TR</b>	Received touches	<b>V</b>	Victory

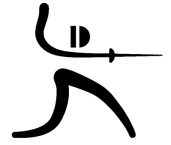

**Draw**

Round of 16	Quarter Final	Semifinals	Gold Medal Match
1 LLAVADOR C. ESP	LLAVADOR C. ESP	LLAVADOR C. ESP	LLAVADOR C. ESP
BYE	12:15 Piste Blue	15-11	15-12
ELICE M. FRA	ELICE M. FRA	15-11	
11:00 Piste Blue	15-11		
TOFALIDES A. CYP			
LUPERI E. ITA	LUPERI E. ITA	16:30 Piste Final	
11:00 Piste Yellow	15-8		
ESSAM M. EGY			
EDIRI A. FRA	12:15 Piste Yellow	HAMZA M. EGY	
11:25 Piste Yellow	HAMZA M. EGY	15-14	
HAMZA M. EGY	15-13		
CUK V. SRB	CUK V. SRB	18:00 Piste Final	GOLD
11:00 Piste Green	15-4		CUK Veljko SRB
MACEDO L. POR			15-9
ABOELKASEM A. EGY	12:15 Piste Green	CUK V. SRB	
11:25 Piste Green	15-4	15-13	
BIBARD T. FRA	ABOELKASEM A. EGY		
BIANCHI G. ITA	BIANCHI G. ITA	16:55 Piste Final	SILVER
11:00 Piste Red	15-4		LLAVADOR Carlos ESP
MINUTO M. TUR			
BYE	12:15 Piste Red	FILIPPI D. ITA	
		15-8	
2 FILIPPI D. ITA	FILIPPI D. ITA		

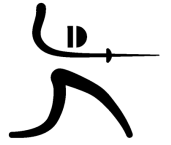

## Standings

As of TUE 5 JUL 2022 at 19:09

Rank	Name	Country
Gold	CUK Veljko	SRB - Serbia
Silver	LLAVADOR Carlos	ESP - Spain
Bronze	FILIPPI Davide	ITA - Italy
Bronze	HAMZA Mohamed	EGY - Egypt
5	LUPERI Edoardo	ITA - Italy
6	BIANCHI Guillaume	ITA - Italy
7	ELICE Meddy	FRA - France
8	ABOELKASEM Alaaeldin	EGY - Egypt
9	BIBARD Tyvan	FRA - France
10	TOFALIDES Alex	CYP - Cyprus
11	MINUTO Martino	TUR - Turkiye
12	ESSAM Mohamed	EGY - Egypt
13	EDIRI Alexandre	FRA - France
14	MACEDO Luis	POR - Portugal
15	FILES Petar	CRO - Croatia
16	HEROUI Salim	ALG - Algeria
17	FELLAH Dani-Adam	ALG - Algeria
18	MADI Youcef	ALG - Algeria

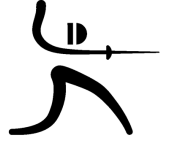

## Medallists

As of TUE 5 JUL 2022 at 20:06

Medal	Name	CTRY
GOLD	ELSISSY Ziad	EGY - Egypt
SILVER	NUCCIO Riccardo	ITA - Italy
BRONZE	BRAVO ARAMBURU Inaki	ESP - Spain
BRONZE	CAVALIERE Dario	ITA - Italy

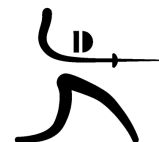

## Entry List by event

As of SAT 2 JUL 2022

CTRY	Name	Date of Birth	Handedness
ALG - Algeria	BOUNABI Akram	28 AUG 1999	
	IZEM Adem Abdelhacib	19 JUL 2001	Right
	SAAD Youcef Abdelaziz	4 JUL 2003	
EGY - Egypt	AMER Mohamed	18 DEC 1997	
	ELSISSY Ziad	15 DEC 1994	
	MOATAZ Adham	23 APR 2003	
ESP - Spain	BRAVO ARAMBURU Inaki	18 MAR 1998	Left
FRA - France	ANNIC Edern	19 JUL 1995	Right
	POGU Antoine	29 MAR 2002	Right
	SEITZ Tom	31 MAY 1994	Right
ITA - Italy	CAVALIERE Dario	16 MAR 1997	Right
	NUCCIO Riccardo	7 NOV 1991	Right
	REPETTI Giovanni	3 AUG 1988	
SLO - Slovenia	KRAJNC Peter	4 NOV 2003	Right
	ZAVIRSEK ZORZ Tei	26 MAR 2001	Right
TUN - Tunisia	FERJANI Ahmed	21 JUN 2000	
	FERJANI Fares	22 JUL 1997	
	HMISSI Amen Allah	12 JUL 2002	
TUR - Turkiye	YILDIRIM Enver	18 OCT 1995	

Total number of fencers: 19



## Pool Results

### Pool No: 1 Piste No: 2 Time: 11:02

#	NAME	CTRY	a	b	c	d	e	f	g	V#	M#	Ind.	TG	TR	Diff.	Rk
1	SEITZ Tom	FRA	---	3	V	V	V	V	V	5	6	0.833	28	11	17	1
1	REPETTI Giovanni	ITA	V	---	4	V	V	V	V	5	6	0.833	29	15	14	2
1	BRAVO ARAMBURU Inaki	ESP	1	V	---	V	V	V	V	5	6	0.833	26	15	11	3
1	FERJANI Fares	TUN	3	1	2	---	V	V	V	3	6	0.500	21	17	4	4
1	MOATAZ Adham	EGY	0	4	2	0	---	V	V	2	6	0.333	16	24	-8	5
1	SAAD Youcef Abdelaziz	ALG	0	1	1	2	3	---	V	1	6	0.166	12	28	-16	6
1	ZAVIRSEK ZORZ Tei	SLO	2	1	1	0	1	3	---	0	6	0.000	8	30	-22	7

### Pool No: 2 Piste No: 3 Time: 11:02

#	NAME	CTRY	a	b	c	d	e	f	V#	M#	Ind.	TG	TR	Diff.	Rk
1	CAVALIERE Dario	ITA	---	V	V	V	V	V	5	5	1.000	25	11	14	1
1	FERJANI Ahmed	TUN	4	---	V	V	3	V	3	5	0.600	22	14	8	2
1	AMER Mohamed	EGY	0	4	---	V	V	V	3	5	0.600	19	14	5	3
1	KRAJNC Peter	SLO	2	0	1	---	V	V	2	5	0.400	13	16	-3	4
1	POGU Antoine	FRA	3	V	3	0	---	V	2	5	0.400	16	20	-4	5
1	BOUNABI Akram	ALG	2	0	0	1	2	---	0	5	0.000	5	25	-20	6

### Pool No: 3 Piste No: 4 Time: 11:01

#	NAME	CTRY	a	b	c	d	e	f	V#	M#	Ind.	TG	TR	Diff.	Rk
1	NUCCIO Riccardo	ITA	---	V	V	V	V	V	5	5	1.000	25	10	15	1
1	ELSISSY Ziad	EGY	1	---	V	V	V	V	4	5	0.800	21	9	12	2
1	YILDIRIM Enver	TUR	3	2	---	V	V	V	3	5	0.600	20	15	5	3
1	ANNIC Edern	FRA	2	0	2	---	V	V	2	5	0.400	14	21	-7	4
1	IZEM Adem Abdelhacib	ALG	2	1	1	3	---	V	1	5	0.200	12	22	-10	5
1	HMISSI Amen Allah	TUN	2	1	2	3	2	---	0	5	0.000	10	25	-15	6

#### LEGEND

<b>D</b> Defeat	<b>Diff.</b> Difference TG-TR	<b>DNF</b> Did Not Finish	<b>DNS</b> Did Not Start
<b>EXC</b> Exclusion	<b>Ind.</b> Calculate index (V#/M#)	<b>M#</b> Number of matches	<b>Rk</b> Rank in pool
<b>V#</b> Number of victories	<b>TG</b> Given touches	<b>TR</b> Received touches	<b>V</b> Victory

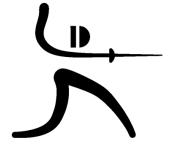

**Draw**

Round of 16	Quarter Final	Semifinals	Gold Medal Match
1 NUCCIO R. ITA	NUCCIO R. ITA	NUCCIO R. ITA	NUCCIO R. ITA
BYE			
YILDIRIM E. TUR	13:00 Piste Blue AMER M. EGY	15-6	
12:00 Piste Blue AMER M. EGY	15-11		
BRAVO I. ESP	13:30 Piste Yellow BRAVO I. ESP	16:30 Piste Final BRAVO I. ESP	15-11
12:00 Piste Yellow POGU A. FRA	15-12	15-13	
ANNIC E. FRA	13:15 Piste Yellow REPETTI G. ITA		
12:15 Piste Yellow REPETTI G. ITA	15-14		
MOATAZ A. EGY	13:00 Piste Green MOATAZ A. EGY	17:30 Piste Final ELSISSY Z. EGY	GOLD ELSISSY Ziad EGY
12:00 Piste Green SEITZ T. FRA	15-12	15-11	15-9
KRAJNC P. SLO	13:00 Piste Green ELSISSY Z. EGY		SILVER
12:15 Piste Green ELSISSY Z. EGY	15-7		
FERJANI F. TUN	13:15 Piste Red FERJANI F. TUN	16:45 Piste Final CAVALIERE D. ITA	NUCCIO Riccardo ITA
12:15 Piste Red FERJANI A. TUN	15-5	15-14	
IZEM A.A. ALG	13:15 Piste Red CAVALIERE D. ITA		
12:30 Piste Red CAVALIERE D. ITA	15-4		

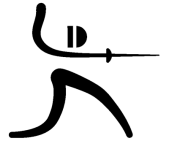

## Standings

As of TUE 5 JUL 2022 at 20:15

Rank	Name	Country
Gold	ELSISSY Ziad	EGY - Egypt
Silver	NUCCIO Riccardo	ITA - Italy
Bronze	BRAVO ARAMBURU Inaki	ESP - Spain
Bronze	CAVALIERE Dario	ITA - Italy
5	REPETTI Giovanni	ITA - Italy
6	AMER Mohamed	EGY - Egypt
7	FERJANI Fares	TUN - Tunisia
8	MOATAZ Adham	EGY - Egypt
9	SEITZ Tom	FRA - France
10	FERJANI Ahmed	TUN - Tunisia
11	YILDIRIM Enver	TUR - Turkiye
12	KRAJNC Peter	SLO - Slovenia
13	POGU Antoine	FRA - France
14	ANNIC Edern	FRA - France
15	IZEM Adem Abdelhacib	ALG - Algeria
16	SAAD Youcef Abdelaziz	ALG - Algeria
17	HMISSI Amen Allah	TUN - Tunisia
18	BOUNABI Akram	ALG - Algeria
19	ZAVIRSEK ZORZ Tei	SLO - Slovenia



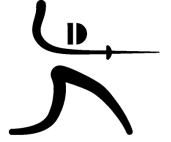

## Medallists

As of TUE 5 JUL 2022 at 20:08

Medal	Name	CTRY
GOLD	RIZZI Giulia	ITA - Italy
SILVER	FOIETTA Nicol	ITA - Italy
BRONZE	MARZANI Roberta	ITA - Italy
BRONZE	VANRYSSEL Eloise	FRA - France



## Entry List by event

As of SAT 2 JUL 2022

CTRY	Name	Date of Birth	Handedness
ALG - Algeria	GUEHAM Maroua	3 SEP 2002	
	MALEK Leia Racha	27 JAN 2004	
	ZEBOU DJ Yousra	22 JAN 2002	
CYP - Cyprus	MAVRIKIOU Iryna	25 MAY 1984	Right
ESP - Spain	FERNANDEZ CALLEJA Sara	19 AUG 1993	Right
FRA - France	LOUIS-MARIE Alexandra	3 MAR 1996	Right
	VANRYSSEL Eloise	1 MAY 1999	Right
	VITALIS Coraline	9 MAY 1995	Right
ITA - Italy	FOIETTA Nicol	6 OCT 1995	Right
	MARZANI Roberta	7 AUG 1996	Right
	RIZZI Giulia	20 JUN 1989	Right
LBN - Lebanon	ABOU JAOUDE Rita	13 JAN 1994	
MKD - Rep. of North Mace	DAMJANOSKA Iskra	6 MAR 2006	
SRB - Serbia	GRIJAK Jana	18 FEB 1999	Right
TUN - Tunisia	MAMI Nour El Houda	27 OCT 2000	
TUR - Turkiye	ERTURK Aleyna	18 AUG 2005	
	GUNAC Gokce	5 JUN 1986	

Total number of fencers: 17

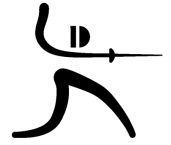

## Pool Results

Pool No: 1 Piste No: 2 Time: 13:00

#	NAME	CTRY	a	b	c	d	e	V#	M#	Ind.	TG	TR	Diff.	Rk
1	FOIETTA Nicol	ITA	---	V	V3	V	V	4	4	1.000	18	7	11	1
1	LOUIS-MARIE Alexandra	FRA	1	---	V4	V	V	3	4	0.750	15	11	4	2
1	FERNANDEZ CALLEJA Sara	ESP	1	2	---	V	V	2	4	0.500	13	11	2	3
1	MAVRIKIOU Iryna	CYP	1	3	3	---	V	1	4	0.250	12	16	-4	4
1	ZEBOUDJ Yousra	ALG	4	1	1	1	---	0	4	0.000	7	20	-13	5

Pool No: 2 Piste No: 3 Time: 13:05

#	NAME	CTRY	a	b	c	d	e	f	V#	M#	Ind.	TG	TR	Diff.	Rk
1	RIZZI Giulia	ITA	---	V	V	3	V	V	4	5	0.800	23	15	8	1
1	VITALIS Coraline	FRA	3	---	V	V	V	V	4	5	0.800	23	16	7	2
1	GRIJAK Jana	SRB	3	4	---	V	V	V	3	5	0.600	22	15	7	3
1	ERTURK Aleyna	TUR	V	1	4	---	V	V	3	5	0.600	20	13	7	4
1	MAMI Nour El Houda	TUN	1	3	0	0	---	V	1	5	0.200	9	24	-15	5
1	MALEK Leia Racha	ALG	3	3	1	0	4	---	0	5	0.000	11	25	-14	6

Pool No: 3 Piste No: 4 Time: 13:05

#	NAME	CTRY	a	b	c	d	e	f	V#	M#	Ind.	TG	TR	Diff.	Rk
1	MARZANI Roberta	ITA	---	V4	V	V4	V	V	5	5	1.000	23	11	12	1
1	VANRYSEL Eloise	FRA	3	---	V	V	V4	V	4	5	0.800	22	11	11	2
1	GUNAC Gokce	TUR	4	1	---	V	V	V	3	5	0.600	20	12	8	3
1	ABOU JAOUDE Rita	LBN	2	1	1	---	V2	V	2	5	0.400	11	19	-8	4
1	GUEHAM Maroua	ALG	1	3	0	1	---	V4	1	5	0.200	9	17	-8	5
1	DAMJANOSKA Iskra	MKD	1	2	1	4	1	---	0	5	0.000	9	24	-15	6

LEGEND

<b>D</b>	Defeat	<b>Diff.</b>	Difference TG-TR	<b>DNF</b>	Did Not Finish	<b>DNS</b>	Did Not Start
<b>EXC</b>	Exclusion	<b>Ind.</b>	Calculate index (V#/M#)	<b>M#</b>	Number of matches	<b>Rk</b>	Rank in pool
<b>V#</b>	Number of victories	<b>TG</b>	Given touches	<b>TR</b>	Received touches	<b>V</b>	Victory

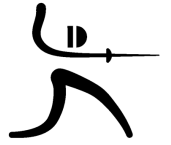

Draw

Round of 16	Quarter Final	Semifinals	Gold Medal Match
1 MARZANI R. ITA BYE	MARZANI R. ITA	MARZANI R. ITA 15-8	<b>GOLD</b>  <b>RIZZI Giulia ITA</b> 15-8    <b>SILVER</b>  <b>FOIETTA Nicol ITA</b>
ERTURK A. TUR 14:45 Piste Blue GRIJAK J. SRB	15:40 Piste Blue GRIJAK J. SRB 15-10	17:15 Piste Final RIZZI G. ITA 15-12	
VITALIS C. FRA 14:45 Piste Yellow MAVRIKIOU I. CYP	15:40 Piste Yellow RIZZI G. ITA 15-0	18:15 Piste Final	
GUEHAM M. ALG 15:05 Piste Yellow RIZZI G. ITA			
3 VANRYSEL E. FRA BYE	VANRYSEL E. FRA	VANRYSEL E. FRA 15-13	
ABOU JAOUDE LBN 14:45 Piste Green LOUIS-MARIE A. FRA	15:40 Piste Green LOUIS-MARIE A. FRA 15-5	17:35 Piste Final FOIETTA N. ITA 15-9	
GUNAC G. TUR 14:45 Piste Red FERNANDEZ S. ESP	15:40 Piste Red FOIETTA N. ITA		
BYE			
2 FOIETTA N. ITA			

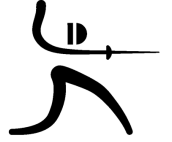

## Standings

As of MON 4 JUL 2022 at 18:44

Rank	Name	Country
Gold	RIZZI Giulia	ITA - Italy
Silver	FOIETTA Nicol	ITA - Italy
Bronze	MARZANI Roberta	ITA - Italy
Bronze	VANRYSSEL Eloise	FRA - France
5	VITALIS Coraline	FRA - France
6	LOUIS-MARIE Alexandra	FRA - France
7	GRIJAK Jana	SRB - Serbia
8	FERNANDEZ CALLEJA Sara	ESP - Spain
9	GUNAC Gokce	TUR - Turkiye
10	ERTURK Alevna	TUR - Turkiye
11	ABOU JAOUDE Rita	LBN - Lebanon
12	MAVRIKIOU Iryna	CYP - Cyprus
13	GUEHAM Maroua	ALG - Algeria
14	MAMI Nour El Houda	TUN - Tunisia
15	ZEBODJ Yousra	ALG - Algeria
16	MALEK Leia Racha	ALG - Algeria
17	DAMJANOSKA Iskra	MKD - Rep. of North Macedonia



Centre MBA - Halle 01 et 02

Fencing

Women's Foil Individual

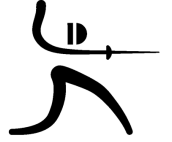

## Medallists

As of TUE 5 JUL 2022 at 20:07

Medal	Name	CTRY
GOLD	CALISSI Olga Rachele	ITA - Italy
SILVER	PATRU Morqane	FRA - France
BRONZE	DIAZ ESCALONA Maria Teresa	ESP - Spain
BRONZE	KARAMETE Irem	TUR - Turkiye



## Entry List by event

As of SAT 2 JUL 2022

CTRY	Name	Date of Birth	Handedness
ALG - Algeria	GUEMMAR Chaima Nihal	24 MAR 2003	
	MEBARKI Meriem	22 JUN 2003	
	ZEBBOUDJ Sonia	21 JUN 2003	
ESP - Spain	DIAZ ESCALONA Maria Teresa	12 DEC 1997	Right
	MARINO Maria Jesus	31 JAN 1993	Right
FRA - France	MARECHAL Jade	2 OCT 2000	Right
	PATRU Morgane	7 FEB 1998	Right
	RECHER Alice	6 APR 1999	Right
ITA - Italy	BATINI Martina	17 APR 1989	Right
	CALISSI Olga Rachele	23 MAR 1992	Left
	CIPRESSA Erica	18 MAY 1996	Right
LBN - Lebanon	ABOU JAOUDE Rita	13 JAN 1994	
POR - Portugal	OLIVEIRA Carolina	2 JUL 1999	Right
TUR - Turkiye	ISBIR Alisa	13 AUG 2005	
	KARAME TE Irem	20 JUN 1993	

Total number of fencers: 15



## Pool Results

Pool No: 1 Piste No: 2 Time: 09:10

#	NAME	CTRY	a	b	c	d	e	f	V#	M#	Ind.	TG	TR	Diff.	Rk
1	CUK Veljko	SRB	---	V	V	V	V	V	5	5	1.000	25	15	10	1
1	BIANCHI Guillaume	ITA	2	---	V	3	V	V	3	5	0.600	20	16	4	2
1	TOFALIDES Alex	CYP	3	2	---	V	V	V	3	5	0.600	20	17	3	3
	ABOELKASEM Alaaeldin	EGY	4	V	3	---	4	V	2	5	0.400	21	22	-1	4
1	EDIRI Alexandre	FRA	4	2	3	V	---	V	2	5	0.400	19	22	-3	5
1	HEROUI Salim	ALG	2	2	1	4	3	---	0	5	0.000	12	25	-13	6

Pool No: 2 Piste No: 3 Time: 09:00

#	NAME	CTRY	a	b	c	d	e	f	V#	M#	Ind.	TG	TR	Diff.	Rk
1	FILIPPI Davide	ITA	---	V	V	V	V	V	5	5	1.000	25	14	11	1
1	HAMZA Mohamed	EGY	4	---	V	V	V	V	4	5	0.800	24	14	10	2
1	BIBARD Tyvan	FRA	3	4	---	V	V	V	3	5	0.600	22	17	5	3
1	MINUTO Martino	TUR	3	1	3	---	V	V	2	5	0.400	17	16	1	4
1	MACEDO Luis	POR	3	2	3	1	---	V	1	5	0.200	14	22	-8	5
1	MADI Youcef	ALG	1	2	1	0	2	---	0	5	0.000	6	25	-19	6

Pool No: 3 Piste No: 4 Time: 09:05

#	NAME	CTRY	a	b	c	d	e	f	V#	M#	Ind.	TG	TR	Diff.	Rk
1	LLAVADOR Carlos	ESP	---	V	V	V	V	V	5	5	1.000	25	7	18	1
1	LUPERI Edoardo	ITA	3	---	V	V	V	V	4	5	0.800	23	14	9	2
1	ELICE Meddy	FRA	1	2	---	V	V	V	3	5	0.600	18	17	1	3
1	ESSAM Mohamed	EGY	2	2	4	---	V	V	2	5	0.400	18	20	-2	4
1	FILES Petar	CRO	1	4	1	2	---	V	1	5	0.200	13	22	-9	5
1	FELLAH Dani-Adam	ALG	0	1	2	3	2	---	0	5	0.000	8	25	-17	6

### LEGEND

<b>D</b>	Defeat	<b>Diff.</b>	Difference TG-TR	<b>DNF</b>	Did Not Finish	<b>DNS</b>	Did Not Start
<b>EXC</b>	Exclusion	<b>Ind.</b>	Calculate index (V#/M#)	<b>M#</b>	Number of matches	<b>Rk</b>	Rank in pool
<b>V#</b>	Number of victories	<b>TG</b>	Given touches	<b>TR</b>	Received touches	<b>V</b>	Victory



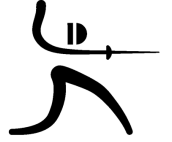

**Draw**

Round of 16	Quarter Final	Semifinals	Gold Medal Match
1 PATRU M. FRA	PATRU M. FRA	PATRU M. FRA 15-7	PATRU M. FRA 15-9
BYE			
MARECHAL J. FRA	15:20 Piste Blue	17:20 Piste Final	18:35 Piste Final
14:30 Piste Blue	ISBIR A. TUR 15-13		
ISBIR A. TUR	BATINI M. ITA	DIAZ M. ESP 15-10	GOLD
BYE	14:30 Piste Yellow		
BATINI M. ITA	15:20 Piste Yellow	CALISSI O. ITA 14-13	SILVER
ABOU JAOUDE LBN	DIAZ M. ESP		
4 DIAZ M. ESP	3 MARINO M.J. ESP	CALISSI O. ITA 15-9	PATRU Morgane FRA
BYE	15:20 Piste Green		
RECHER A. FRA	MARINO M.J. ESP	17:45 Piste Final	SILVER
14:30 Piste Green	CALISSI O. ITA 15-7		
CALISSI O. ITA	KARAMETE I. TUR	KARAMETE I. TUR 15-11	SILVER
BYE	14:30 Piste Red		
OLIVEIRA C. POR	15:20 Piste Red	CIPRESSA E. ITA	SILVER
BYE	KARAMETE I. TUR 15-11		
2 CIPRESSA E. ITA	CIPRESSA E. ITA		

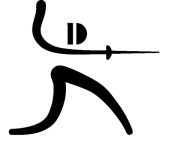

## Standings

As of TUE 5 JUL 2022 at 19:09

Rank	Name	Country
Gold	CALISSI Olga Rachele	ITA - Italy
Silver	PATRU Morgane	FRA - France
Bronze	DIAZ ESCALONA Maria Teresa	ESP - Spain
Bronze	KARAMETE Irem	TUR - Turkiye
5	CIPRESSA Erica	ITA - Italy
6	MARINO Maria Jesus	ESP - Spain
7	BATINI Martina	ITA - Italy
8	ISBIR Alisa	TUR - Turkiye
9	MARECHAL Jade	FRA - France
10	OLIVEIRA Carolina	POR - Portugal
11	RECHER Alice	FRA - France
12	ABOU JAOUDE Rita	LBN - Lebanon
13	MEBARKI Meriem	ALG - Algeria
14	ZEBBOUDJ Sonia	ALG - Algeria
15	GUEMMAR Chaima Nihal	ALG - Algeria

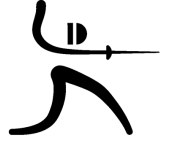

## Medallists

As of SUN 3 JUL 2022 at 18:38

Medal	Name	CTRY
GOLD	BOUDIAF Saoussen Dlindah	ALG - Algeria
SILVER	MORMILE Chiara	ITA - Italy
BRONZE	GARGANO Rebecca	ITA - Italy
BRONZE	PASSARO Eloisa	ITA - Italy

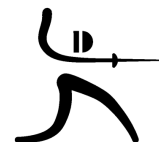

## Entry List by event

As of TUE 5 JUL 2022

CTRY	Name	Date of Birth	Handedness
ALG - Algeria	BOUDIAF Saoussen Dlindah	31 DEC 1993	
	KEHLI Zohra Nora	17 JAN 2001	
	MOHAMMED BELKBIR Kaouther	5 AUG 2003	
ESP - Spain	MARTIN PORTUGUES Lucia	22 OCT 1990	Right
	NAVARRO LASO Araceli	9 AUG 1989	Right
FRA - France	AIME Amalia	27 AUG 2002	Right
	LEMBACH Charlotte	1 APR 1988	Right
	VONGSAVADY Malina	17 MAY 1997	Right
ITA - Italy	GARGANO Rebecca	4 JUL 1996	Right
	MORMILE Chiara	30 MAY 1995	Right
	PASSARO Eloisa	12 JUL 1997	
TUN - Tunisia	DAGHFOUS Yasmine	1 JAN 2000	
TUR - Turkiye	ERBIL Nisanur	22 APR 2003	
	SHCHUKLA Iryna	13 OCT 1995	
	UNLUDAG Deniz Selin	19 APR 2001	

Total number of fencers: 15



## Pool Results

Pool No: 1 Piste No: 2 Time: 13:31

#	NAME	CTRY	a	b	c	d	e	f	g	V#	M#	Ind.	TG	TR	Diff.	Rk
1	VONGSAVADY Malina	FRA	---	V	V	V	V	V	V	6	6	1.000	30	18	12	1
1	LEMBACH Charlotte	FRA	4	---	V	V	V	V	V	5	6	0.833	29	15	14	2
1	KEHLI Zohra Nora	ALG	2	2	---	V	3	V	4	2	6	0.333	21	24	-3	4
1	PASSARO Eloisa	ITA	4	2	3	---	V	V	4	2	6	0.333	23	27	-4	5
1	MOHAMMED BELKBIR Kaouther	ALG	2	2	V	3	---	V	3	2	6	0.333	20	27	-7	6
1	DAGHFOUS Yasmine	TUN	2	1	1	4	4	---	1	0	6	0.000	13	30	-17	7
7	MARTIN PORTUGUES Lucia	ESP	4	3	V	V	V	V	---	4	6	0.666	27	22	5	3

Pool No: 2 Piste No: 4 Time: 13:31

#	NAME	CTRY	a	b	c	d	e	f	V#	M#	Ind.	TG	TR	Diff.	Rk
1	BOUDIAF Saoussen Dlindah	ALG	---	V	4	V	V	V	4	5	0.800	24	15	9	1
1	MORMILE Chiara	ITA	2	---	V	V	V	V	4	5	0.800	22	15	7	2
1	SHCHUKLA Iryna	TUR	V	2	---	4	V	V	3	5	0.600	21	18	3	3
1	GARGANO Rebecca	ITA	4	3	V	---	3	V	2	5	0.400	20	20	0	4
1	NAVARRO LASO Araceli	ESP	4	2	2	V	---	4	1	5	0.200	17	23	-6	5
1	AIME Amalia	FRA	0	3	2	1	V	---	1	5	0.200	11	24	-13	6

### LEGEND

<b>D</b>	Defeat	<b>Diff.</b>	Difference TG-TR	<b>DNF</b>	Did Not Finish	<b>DNS</b>	Did Not Start
<b>EXC</b>	Exclusion	<b>Ind.</b>	Calculate index (V#/M#)	<b>M#</b>	Number of matches	<b>Rk</b>	Rank in pool
<b>V#</b>	Number of victories	<b>TG</b>	Given touches	<b>TR</b>	Received touches	<b>V</b>	Victory

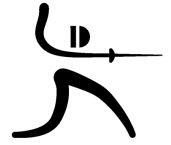

## Draw

Round of 16	Quarter Final	Semifinals	Gold Medal Match
1 VONGSAVADY FRA BYE	VONGSAVADY FRA 15:15 Piste Blue	PASSARO E. ITA 15-12	MORMILE C. ITA 15-12
PASSARO E. ITA 14:45 Piste Blue	PASSARO E. ITA 15-13		
5 MARTIN L. ESP BYE	MARTIN L. ESP 13:30 Piste Yellow	MORMILE C. ITA 15-6	MORMILE C. ITA 15-12
4 MORMILE C. ITA BYE	MORMILE C. ITA		
3 BOUDIAF S. ALG BYE	BOUDIAF S. ALG 15:15 Piste Green	BOUDIAF S. ALG 15-12	BOUDIAF Saoussen Dindah ALG 15-7
6 SHCHUKLA I. TUR BYE	SHCHUKLA I. TUR		
GARGANO R. ITA 14:45 Piste Red	GARGANO R. ITA 15-8	GARGANO R. ITA 15-12	MORMILE Chiara ITA
MOHAMMED K. ALG BYE	GARGANO R. ITA 15:30 Piste Red		
2 LEMBACH C. FRA BYE	LEMBACH C. FRA		



## Standings

As of TUE 5 JUL 2022 at 20:14

Rank	Name	Country
Gold	BOUDIAF Saoussen Dlindah	ALG - Algeria
Silver	MORMILE Chiara	ITA - Italy
Bronze	GARGANO Rebecca	ITA - Italy
Bronze	PASSARO Eloisa	ITA - Italy
5	VONGSAVADY Malina	FRA - France
6	LEMBACH Charlotte	FRA - France
7	MARTIN PORTUGUES Lucia	ESP - Spain
8	SHCHUKLA Iryna	TUR - Turkiye
9	KEHLI Zohra Nora	ALG - Algeria
10	MOHAMMED BELKBIR Kaouther	ALG - Algeria
11	NAVARRO LASO Araceli	ESP - Spain
12	AIME Amalia	FRA - France
13	DAGHFOUS Yasmine	TUN - Tunisia



ألعاب البحر الأبيض المتوسط  
MEDITERRANEAN GAMES  
JEUX MÉDITERRANÉENS  
du 25 juin au 06 juillet

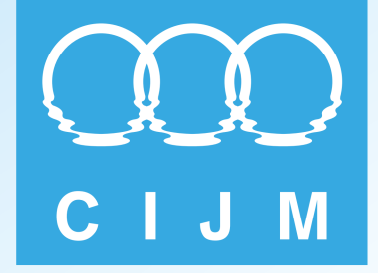

# Results Book



## Gymnastics



**TOSYALI  
ALGERIE**

Fer et Acier

سوناطراك



sonarach



microplus  
DATA PROCESSING & TIMING  
[www.microplustiming.com](http://www.microplustiming.com)





## Competition Schedule

As of WED 29 JUN 2022 at 18 :40

Date	Start Time	Estimated Finish Time	Event	Details
SUN 26 JUN 2022	15 :00	15 :40	Women's Qualifications and Team Final	Sub 1 - Rot 1
	15 :40	16 :20		Sub 1 - Rot 2
	16 :20	17 :00		Sub 1 - Rot 3
	17 :00	17 :40		Sub 1 - Rot 4
	19 :00	19 :30		Sub 2 - Rot 1
	19 :30	20 :00		Sub 2 - Rot 2
	20 :00	20 :30		Sub 2 - Rot 3
	20 :30	21 :00		Sub 2 - Rot 4
MON 27 JUN 2022	15 :00	15 :30	Men's Qualifications and Team Final	Sub 1 - Rot 1
	15 :30	16 :00		Sub 1 - Rot 2
	16 :00	16 :30		Sub 1 - Rot 3
	16 :30	17 :00		Sub 1 - Rot 4
	17 :00	17 :30		Sub 1 - Rot 5
	17 :30	18 :00		Sub 1 - Rot 6
	19 :00	19 :30		Sub 2 - Rot 1
	19 :30	20 :00		Sub 2 - Rot 2
	20 :00	20 :30		Sub 2 - Rot 3
	20 :30	21 :00		Sub 2 - Rot 4
	21 :00	21 :30		Sub 2 - Rot 5
	21 :30	22 :00		Sub 2 - Rot 6
TUE 28 JUN 2022	10 :00	10 :30	Women's Individual All-Around Final	Rotation 1
	10 :30	11 :00		Rotation 2
	11 :00	11 :30		Rotation 3
	11 :30	12 :00		Rotation 4
	16 :00	16 :30	Men's Individual All-Around Final	Rotation 1
	16 :30	17 :00		Rotation 2
	17 :00	17 :30		Rotation 3
	17 :30	18 :00		Rotation 4
	18 :00	18 :30		Rotation 5
	18 :30	19 :00		Rotation 6



## Competition Schedule

As of WED 29 JUN 2022 at 18 :40

Date	Start Time	Estimated Finish Time	Event	Details
WED 29 JUN 2022	09 :30	10 :00	Women's Apparatus Finals	Vault Final
	10 :00	10 :30		Uneven Bars Final
	10 :30	11 :00		Balance Beam Final
	11 :00	11 :30		Floor Final
	15 :00	15 :30	Men's Apparatus Finals	Floor Final
	15 :30	16 :00		Pommel Horse Final
	16 :00	16 :30		Rings Final
	16 :30	17 :00		Vault Final
	17 :00	17 :30		Parallel Bars Final
	17 :30	18 :00		Horizontal Bar Final



## ENTRY LIST BY NOC

As of SUN 26 JUL 2022

NOC		Number of Gymnasts
<b>ALG</b>	Algeria	<b>5</b>
<b>CRO</b>	Croatia	<b>3</b>
<b>CYP</b>	Cyprus	<b>2</b>
<b>EGY</b>	Egypt	<b>5</b>
<b>ESP</b>	Spain	<b>5</b>
<b>FRA</b>	France	<b>5</b>
<b>ITA</b>	Italy	<b>5</b>
<b>KOS</b>	Kosovo	<b>1</b>
<b>POR</b>	Portugal	<b>4</b>
<b>SLO</b>	Slovenia	<b>5</b>
<b>TUR</b>	Turkiye	<b>5</b>
<b>11</b>		<b>45</b>



## ENTRY LIST BY NOC

As of MON 27 JUL 2022

NOC		Number of Gymnasts
<b>ALB</b>	Albania	<b>1</b>
<b>ALG</b>	Algeria	<b>5</b>
<b>BIH</b>	Bosnie-Herzégovine	<b>1</b>
<b>CRO</b>	Croatia	<b>3</b>
<b>CYP</b>	Cyprus	<b>5</b>
<b>EGY</b>	Egypt	<b>5</b>
<b>ESP</b>	Spain	<b>5</b>
<b>FRA</b>	France	<b>5</b>
<b>GRE</b>	Greece	<b>5</b>
<b>ITA</b>	Italy	<b>5</b>
<b>KOS</b>	Kosovo	<b>1</b>
<b>MON</b>	Monaco	<b>1</b>
<b>POR</b>	Portugal	<b>4</b>
<b>SLO</b>	Slovenia	<b>2</b>
<b>SRB</b>	Serbia	<b>2</b>
<b>SYR</b>	Syrian Arab Rep.	<b>3</b>
<b>TUR</b>	Turkiye	<b>5</b>
<b>17</b>		<b>58</b>

## Medallists by Event

As of WED 29 JUN 2022 at 18 :40  
After 14 of 14 Events

Event	Date	Medal	Name	NOC Code
Women's Team Final	SUN 26 JUN	GOLD SYLVER BRONZE	Italy France Spain	ITA FRA ESP
Men's Team Final	MON 27 JUN	GOLD SYLVER BRONZE	Turkiye Italy France	TUR ITA FRA
Women's All-Around Final	TUE 28 JUN	GOLD SYLVER BRONZE	Martina MAGGIO Asia D'AMATO Carolann HEDUIT	ITA ITA FRA
Men's All-Around Final	TUE 28 JUN	GOLD SYLVER BRONZE	Adem ASIL Joel PLATA RODRIGUEZ Marios GEORGIOU	TUR ESP CYP
Women's Vault Final	WED 29 JUN	GOLD SYLVER BRONZE	Asia D'AMATO Morgane Angele OSYSSEK-REIMER Angela ANDREOLI	ITA FRA ITA
Women's Uneven Bars Final	WED 29 JUN	GOLD SYLVER BRONZE	Giorgia VILLA Martina MAGGIO Ana Filipa DA SILVA MARTINS	ITA ITA POR
Women's Balance Beam Final	WED 29 JUN	GOLD SYLVER BRONZE	Martina MAGGIO Asia D'AMATO Carolann HEDUIT	ITA ITA FRA
Women's Floor Exercise Final	WED 29 JUN	GOLD SYLVER BRONZE	Asia D'AMATO Martina MAGGIO Morgane Angele OSYSSEK-REIMER	ITA ITA FRA
Men's Floor Exercise Final	WED 29 JUN	GOLD SYLVER BRONZE	Nicola BARTOLINI Ahmet ONDER Adem ASIL	ITA TUR TUR
Men's Pommel Horse Final	WED 29 JUN	GOLD SYLVER BRONZE	Mateo ZUGEC Jakov VLAHEK Ferhat ARICAN	CRO CRO TUR
Men's Ring Final	WED 29 JUN	GOLD SYLVER BRONZE	Ibrahim COLAK Adem ASIL Ali ZAHARAN	TUR TUR EGY
Men's Vault Final	WED 29 JUN	GOLD SYLVER BRONZE	Adem ASIL Nicola BARTOLINI Matteo LEVANTESI	TUR ITA ITA



### Medallists by Event

Event	Date	Medal	Name	NOC Code
Men's Parallel Bars Final	WED 29 JUN	GOLD	Ferhat ARICAN	TUR
		SYLVER	Matteo LEVANTESI	ITA
		BRONZE	Cameron-lie BERNARD	FRA
Men's Horizontal Bar Final	WED 29 JUN	GOLD	Marios GEORGIU	CYP
		SYLVER	Adem ASIL	TUR
		BRONZE	Ahmet ONDER	TUR



## Medal Standings

As of WED 29 JUN 2022 at 18 :40  
After 14 of 14 Events

Rk	NOC	Nation	Men				Women				Total				Rank By Total
			Gold	Silver	Bronze	Total	Gold	Silver	Bronze	Total	Gold	Silver	Bronze	Total	
1	ITA	Italy	1	3	1	5	6	4	1	11	7	7	2	16	1
2	TUR	Turkiye	5	3	3	11					5	3	3	11	2
3	CRO	Croatia	1	1		2					1	1		2	4
4	CYP	Cyprus	1		1	2					1		1	2	4
5	FRA	France			2	2		2	3	5		2	5	7	3
6	ESP	Spain		1		1			1	1		1	1	2	4
7	EGY	Egypt			1	1							1	1	7
7	POR	Portugal							1	1			1	1	7
<b>Total :</b>			<b>8</b>	<b>8</b>	<b>8</b>	<b>24</b>	<b>6</b>	<b>6</b>	<b>6</b>	<b>18</b>	<b>14</b>	<b>14</b>	<b>14</b>	<b>42</b>	



## ENTRY LIST BY BIB NUMBER

As of SUN 26 JUL 2022

Bib	FIG License number	Name	NOC	Year of Birth
62	16149	SALEM Lahna	ALG	1996
64	49585	BOUKHATEM Fatma Zohra	ALG	2006
65	45080	NAIR Sofia	ALG	2006
66	35840	HAMIDI Sihem	ALG	2006
67	49599	SEDHANE Rihab Sidra	ALG	2006
68	35266	ZWICKER Christina	CRO	2002
69	21313	DEREK Ana	CRO	1998
70	3681	KORENT Tijana	CRO	1989
71	54931	BACHURINA Tatiana	CYP	2002
72	48186	DIMITRIOU Evangelina	CYP	2005
73	47537	ABDELSALAM Jana	EGY	2006
74	44584	ABOELHASAN Jana	EGY	2005
76	44582	MAHMOUD Jana	EGY	2004
77	35727	SHARAF Zeina	EGY	2003
78	49631	SWIDAN Nour	EGY	2006
79	54741	CASABUENA Laura	ESP	2005
80	35573	FERNANDEZ Emma	ESP	2002
82	40595	MEDINA Lorena	ESP	2003
83	44013	PETISCO Alba	ESP	2003
84	44132	VILLALBA Claudia	ESP	2004
86	31691	CHARPY Lorette	FRA	2001
87	39585	HEDUIT Carolann	FRA	2003
88	48297	LAROUJ Djenna	FRA	2005
89	34764	OSYSSEK-REIMER Morgane	FRA	2002
90	34761	SERBER Celia	FRA	2003
91	35298	D'AMATO Asia	ITA	2003
92	31859	MAGGIO Martina	ITA	2001
93	47313	ANDREOLI Angela	ITA	2006
94	35297	VILLA Giorgia	ITA	2003
95	55516	RAMA Valeza	KOS	2006
96	48024	COSTA Mafalda	POR	2005
97	12254	DA SILVA MARTINS Ana	POR	2006
98	44493	SOBRAL Lia	POR	2004
99	55679	PARENTE Mariana	POR	2006
100	31618	HRIBAR Lucija	SLO	2001
101	29120	KING Sara	SLO	1998
102	12206	BELAK Teja	SLO	1994
103	8686	KYSSELEF Tjasa	SLO	1993
104	51713	KAYISOGLU Sevgi	TUR	2005
105	38486	SAVRANBASI Nazli	TUR	2003
106	46275	TARHAN Bilge	TUR	2004
107	3801	UCTAS SANLI Goksu	TUR	1990

Report created FRI 1 JUL 2022 17:01:39

Data Processing and Timing by Microplus — [www.microplustiming.com](http://www.microplustiming.com)





Salle Complexe Olympique  
Artistic Gymnastics  
Women's Artistic Gymnastic



## ENTRY LIST BY BIB NUMBER

As of SUN 26 JUL 2022

Bib	FIG License number	Name	NOC	Year of Birth
108	51714	YILDIZ Bengisu	TUR	2006
109	35299	D'AMATO Alice	ITA	2003
111	49993	TRTNIK Zala	SLO	2006

Report created FRI 1 JUL 2022 17:01:39

Data Processing and Timing by Microplus — [www.microplustiming.com](http://www.microplustiming.com)





## START LIST

Women's Qualifications and Team Final  
SUBDIVISION 1 of 2 - ROTATION 1 of 4  
26 June 2022 - 15:00 to 15:40

**REVISED**  
**12:57 26 jun 2022**

### VAULT

Bib Name	NOC
096 COSTA Mafalda	POR
099 PARENTE Mariana	POR *
098 SOBRAL Lia	POR
097 DA SILVA MARTINS Ana	POR
074 ABOELHASAN Jana	EGY
073 ABDELSALAM Jana	EGY
076 MAHMOUD Jana	EGY *
078 SWIDAN Nour	EGY
071 BACHURINA Tatiana	CYP
072 DIMITRIOU Evangelina	CYP

### UNEVEN BARS

Bib Name	NOC
066 HAMIDI Sihem	ALG
065 NAIR Sofia	ALG
064 BOUKHATEM Fatma Zohra	ALG
062 SALEM Lahna	ALG
111 TRTNIK Zala	SLO
100 HRIBAR Lucija	SLO
101 KING Sara	SLO
095 RAMA Valeza	KOS

### BEAM

Bib Name	NOC
----------	-----

### FLOOR

Bib Name	NOC
----------	-----



## START LIST

### Women's Qualifications and Team Final SUBDIVISION 1 of 2 - ROTATION 2 of 4

26 June 2022 - 15:40 to 16:20

**REVISED**  
**12:57 26 jun 222**

### VAULT

Bib Name	NOC
----------	-----

### UNEVEN BARS

Bib Name	NOC
----------	-----

096 COSTA Mafalda	POR
099 PARENTE Mariana	POR
098 SOBRAL Lia	POR
097 DA SILVA MARTINS Ana	POR
074 ABOELHASAN Jana	EGY
077 SHARAF Zeina	EGY
076 MAHMOUD Jana	EGY
073 ABDELSALAM Jana	EGY
072 DIMITRIOU Evangelina	CYP
071 BACHURINA Tatiana	CYP

### BEAM

Bib Name	NOC
----------	-----

066 HAMIDI Sihem	ALG
064 BOUKHATEM Fatma Zohra	ALG
065 NAIR Sofia	ALG
062 SALEM Lahna	ALG
101 KING Sara	SLO
100 HRIBAR Lucija	SLO
103 KYSELEF Tjasa	SLO
069 DEREK Ana	CRO
095 RAMA Valeza	KOS

### FLOOR

Bib Name	NOC
----------	-----



## START LIST

### Women's Qualifications and Team Final SUBDIVISION 1 of 2 - ROTATION 3 of 4

26 June 2022 - 16:20 to 17:00

**REVISED**  
**12:57 26 jun 2022**

### VAULT

### UNEVEN BARS

Bib Name	NOC	Bib Name	NOC
----------	-----	----------	-----

### BEAM

### FLOOR

Bib Name	NOC	Bib Name	NOC
099 PARENTE Mariana	POR	066 HAMIDI Sihem	ALG
098 SOBRAL Lia	POR	064 BOUKHATEM Fatma Zohra	ALG
096 COSTA Mafalda	POR	065 NAIR Sofia	ALG
097 DA SILVA MARTINS Ana	POR	062 SALEM Lahna	ALG
073 ABDELSALAM Jana	EGY	101 KING Sara	SLO
077 SHARAF Zeina	EGY	100 HRIBAR Lucija	SLO
076 MAHMOUD Jana	EGY	069 DEREK Ana	CRO
074 ABOELHASAN Jana	EGY	095 RAMA Valeza	KOS
072 DIMITRIOU Evangelina	CYP		
071 BACHURINA Tatiana	CYP		



## START LIST

### Women's Qualifications and Team Final SUBDIVISION 1 of 2 - ROTATION 4 of 4

26 June 2022 - 17:00 to 17:40

**REVISED**  
**12:57 26 jun 2022**

### VAULT

Bib Name	NOC
066 HAMIDI Sihem	ALG
064 BOUKHATEM Fatma Zohra	ALG
062 SALEM Lahna	ALG
065 NAIR Sofia	ALG
100 HRIBAR Lucija	SLO
103 KYSELEF Tjasa	SLO *
101 KING Sara	SLO
070 KORENT Tijana	CRO *

### UNEVEN BARS

Bib Name	NOC
099 PARENTE Mariana	POR
098 SOBRAL Lia	POR
096 COSTA Mafalda	POR
097 DA SILVA MARTINS Ana	POR
078 SWIDAN Nour	EGY
073 ABDELSALAM Jana	EGY
076 MAHMOUD Jana	EGY
074 ABOELHASAN Jana	EGY
071 BACHURINA Tatiana	CYP
072 DIMITRIOU Evangelina	CYP

### BEAM

Bib Name	NOC
----------	-----

### FLOOR

Bib Name	NOC
099 PARENTE Mariana	POR
098 SOBRAL Lia	POR
096 COSTA Mafalda	POR
097 DA SILVA MARTINS Ana	POR
078 SWIDAN Nour	EGY
073 ABDELSALAM Jana	EGY
076 MAHMOUD Jana	EGY
074 ABOELHASAN Jana	EGY
071 BACHURINA Tatiana	CYP
072 DIMITRIOU Evangelina	CYP



## START LIST

### Women's Qualifications and Team Final SUBDIVISION 2 of 2 - ROTATION 1 of 4

26 June 2022 - 19:00 to 19:30

#### VAULT

Bib Name	NOC
086 CHARPY Lorette	FRA
089 OSYSSEK-REIMER Morgane	FRA *
087 HEDUIT Carolann	FRA
090 SERBER Celia	FRA
088 LAROUI Djenna	FRA
092 MAGGIO Martina	ITA
091 D'AMATO Asia	ITA *
109 D'AMATO Alice	ITA
093 ANDREOLI Angela	ITA *

#### UNEVEN BARS

Bib Name	NOC
080 FERNANDEZ Emma	ESP
079 CASABUENA Laura	ESP
083 PETISCO Alba	ESP
082 MEDINA Lorena	ESP
084 VILLALBA Claudia	ESP
108 YILDIZ Bengisu	TUR
104 KAYISOGLU Sevgi	TUR
106 TARHAN Bilge	TUR
105 SAVRANBASI Nazli	TUR
107 UCTAS SANLI Goksu	TUR

#### BEAM

Bib Name	NOC
----------	-----

#### FLOOR

Bib Name	NOC
----------	-----



## START LIST

Women's Qualifications and Team Final  
SUBDIVISION 2 of 2 - ROTATION 2 of 4  
26 June 2022 - 19:30 to 20:00

### VAULT

Bib Name	NOC
----------	-----

### UNEVEN BARS

Bib Name	NOC
----------	-----

088 LAROUJ Djenna	FRA
090 SERBER Celia	FRA
087 HEDUIT Carolann	FRA
086 CHARPY Lorette	FRA
089 OSYSSEK-REIMER Morgane	FRA
094 VILLA Giorgia	ITA
109 D'AMATO Alice	ITA
091 D'AMATO Asia	ITA
092 MAGGIO Martina	ITA
093 ANDREOLI Angela	ITA

### BEAM

Bib Name	NOC
----------	-----

084 VILLALBA Claudia	ESP
079 CASABUENA Laura	ESP
083 PETISCO Alba	ESP
080 FERNANDEZ Emma	ESP
082 MEDINA Lorena	ESP
108 YILDIZ Bengisu	TUR
104 KAYISOGLU Sevgi	TUR
106 TARHAN Bilge	TUR
107 UCTAS SANLI Goksu	TUR
105 SAVRANBASI Nazli	TUR

### FLOOR

Bib Name	NOC
----------	-----



## START LIST

Women's Qualifications and Team Final  
SUBDIVISION 2 of 2 - ROTATION 3 of 4  
26 June 2022 - 20:00 to 20:30

### VAULT

Bib Name	NOC
----------	-----

### UNEVEN BARS

Bib Name	NOC
----------	-----

### BEAM

Bib Name	NOC
087 HEDUIT Carolann	FRA
089 OSYSSEK-REIMER Morgane	FRA
086 CHARPY Lorette	FRA
090 SERBER Celia	FRA
094 VILLA Giorgia	ITA
092 MAGGIO Martina	ITA
091 D'AMATO Asia	ITA
093 ANDREOLI Angela	ITA
109 D'AMATO Alice	ITA

### FLOOR

Bib Name	NOC
080 FERNANDEZ Emma	ESP
079 CASABUENA Laura	ESP
083 PETISCO Alba	ESP
082 MEDINA Lorena	ESP
084 VILLALBA Claudia	ESP
108 YILDIZ Bengisu	TUR
106 TARHAN Bilge	TUR
104 KAYISOGLU Sevgi	TUR
107 UCTAS SANLI Goksu	TUR
105 SAVRANBASI Nazli	TUR





## START LIST

Women's Qualifications and Team Final  
SUBDIVISION 2 of 2 - ROTATION 4 of 4  
26 June 2022 - 20:30 to 21:00

### VAULT

Bib Name	NOC
080 FERNANDEZ Emma	ESP
079 CASABUENA Laura	ESP *
082 MEDINA Lorena	ESP *
083 PETISCO Alba	ESP
084 VILLALBA Claudia	ESP
105 SAVRANBASI Nazli	TUR
107 UCTAS SANLI Goksu	TUR
108 YILDIZ Bengisu	TUR *
106 TARHAN Bilge	TUR *
104 KAYISOGLU Sevgi	TUR

### UNEVEN BARS

Bib Name	NOC
----------	-----

### BEAM

Bib Name	NOC
----------	-----

### FLOOR

Bib Name	NOC
086 CHARPY Lorette	FRA
087 HEDUIT Carolann	FRA
089 OSYSSEK-REIMER Morgane	FRA
088 LAROUI Djenna	FRA
090 SERBER Celia	FRA
092 MAGGIO Martina	ITA
109 D'AMATO Alice	ITA
091 D'AMATO Asia	ITA
093 ANDREOLI Angela	ITA



## JUDGES ASSIGNMENT

### XIX Mediterranean Games Oran 2022

26-Jun-22

#### Qualification



#### Competition Superior Jury

Nehad ZAYED

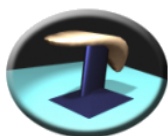

Number	JUDGES			Nation
--------	--------	--	--	--------

<b>D1</b>	4	AHMED ELMERIDI	Mariam	EGY
<b>D2</b>	6	MIQUEL	Stephane	FRA
<b>E1</b>	8	CORTIGIANI	Dora	ITA
<b>E2</b>	9	CARVALHO	Joana	POR
<b>E3</b>	10	HORVAT	Carmen	SLO
<b>E4</b>	3	MICHAIL	Elpida	CYP
<b>Line</b>	16	BELKHIR	IMENE	ALG



Number	JUDGES			Nation
--------	--------	--	--	--------

<b>D1</b>	7	COCUZZA	Maria	ITA
<b>D2</b>	2	LEDERER	Dunja	CRO
<b>E1</b>	12	GARCIA BEN	ZELTIA NATIVIDADE	ESP
<b>E2</b>	5	ASAAD	Heba	EGY
<b>E3</b>	11	PUSNIK	Vika	SLO
<b>E4</b>	14	GULER YILMAZ	MERGUL	TUR
<b>Timer</b>	19	IDDIR	LYLIA	ALG

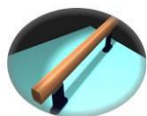

Number	JUDGES			Nation
--------	--------	--	--	--------

<b>D1</b>	4	AHMED ELMERIDI	Mariam	EGY
<b>D2</b>	6	MIQUEL	Stephane	FRA
<b>E1</b>	8	CORTIGIANI	Dora	ITA
<b>E2</b>	9	CARVALHO	Joana	POR
<b>E3</b>	10	HORVAT	Carmen	SLO
<b>E4</b>	3	MICHAIL	Elpida	CYP
<b>Time 1</b>	16	BELKHIR	IMENE	ALG
<b>Time 2</b>	18	HAMIDI	MAJDA	ALG

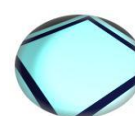

Number	JUDGES			Nation
--------	--------	--	--	--------

<b>D1</b>	7	COCUZZA	Maria	ITA
<b>D2</b>	2	LEDERER	Dunja	CRO
<b>E1</b>	12	GARCIA BEN	ZELTIA NATIVIDADE	ESP
<b>E2</b>	5	ASAAD	Heba	EGY
<b>E3</b>	11	PUSNIK	Vika	SLO
<b>E4</b>	13	DAGISTANLI	SIBEL	TUR
<b>Time</b>	21	AYAD	Dahbia	ALG
<b>Line 1</b>	15	KOUMIA	NEILA	ALG
<b>Line 2</b>	17	BENCHKH	AYA	ALG





0

0



## RESULTS

### WOMEN'S QUALIFICATIONS AND TEAM FINAL

Rank	Bib	NOC Name					Pen.	Total	Ind. Rk
<b>1</b>		<b>ITA - Italy</b>							
	092	MAGGIO Martina	13,650	13.800	13.750	13.500		54.700	( 1)
	091	D'AMATO Asia	13,850	13.600	13.750	13.200		54.400	( 2)
	109	D'AMATO Alice	13,800	12.750		11.200		37.750	(24)
	093	ANDREOLI Angela	12,700		13.000	12.000		37.700	(25)
	094	VILLA Giorgia		13.850	13.200			27.050	(30)
		<b>Total</b>	(1) 41.300	(1) 41.250	(1) 40.700	(1) 38.700		<b>161.950</b>	
<b>2</b>		<b>FRA - France</b>							
	087	HEDUIT Carolann	13,750	13.500	13.500	12.000		52.750	( 3)
	086	CHARPY Lorette	13,150	13.650	13.200	11.500		51.500	( 4)
	089	OSYSSEK-REIMER Morgane	13,300		13.400	12.850		39.550	(23)
	090	SERBER Celia	DNS	12.800	12.100			24.900	(35)
	088	LAROUI Djenna		12.350		11.200		23.550	(36)
		<b>Total</b>	(2) 40.200	(2) 39.950	(2) 40.100	(4) 36.350		<b>156.600</b>	
<b>3</b>		<b>ESP - Spain</b>							
	080	FERNANDEZ Emma	12,850	11.450	12.250	12.150		48.700	( 6)
	079	CASABUENA Laura	11,600	11.550	12.700	12.550		48.400	( 8)
	083	PETISCO Alba	13,200	12.050	10.650	12.350		48.250	( 9)
	082	MEDINA Lorena	12,950	11.850		12.000		36.800	(27)
	084	VILLALBA Claudia			12.000			12.000	(41)
		<b>Total</b>	(3) 39.000	(5) 35.450	(3) 36.950	(2) 37.050		<b>148.450</b>	
<b>4</b>		<b>TUR - Turkey</b>							
	108	YILDIZ Bengisu	13,000	11.800	11.600	12.050		48.450	( 7)
	106	TARHAN Bilge	12,900	11.850	11.250	11.600		47.600	(11)
	107	UCTAS SANLI Goksu	12,900		11.600	12.400		36.900	(26)
	104	KAYISOGLU Sevgi		11.300	11.900	11.950		35.150	(28)
	105	SAVRANBASI Nazli	12,650	12.750				25.400	(33)
		<b>Total</b>	(4) 38.800	(3) 36.400	(5) 35.100	(3) 36.400		<b>146.700</b>	
<b>5</b>		<b>POR - Portugal</b>							
	099	PARENTE Mariana	12,550	10.850	12.000	11.550		46.950	(12)
	098	SOBRAL Lia	12,250	11.100	11.250	11.450		46.050	(13)
	096	COSTA Mafalda	12,250	11.400	10.550	11.200		45.400	(15)
	097	DA SILVA MARTINS Ana	DNS	13.850	12.450	DNS		26.300	(31)
		<b>Total</b>	(7) 37.050	(4) 36.350	(4) 35.700	(6) 34.200		<b>143.300</b>	





Report created SUN 26 JUN 2022 21:07:23

Data Processing and Timing by Microplus — www.microplustiming.com



## RESULTS

### WOMEN'S QUALIFICATIONS AND TEAM FINAL

Rank	Bib	NOC Name					Pen.	Total	Ind. Rk
<b>6 EGY - Egypt</b>									
	073	ABDELSALAM Jana	12,900	11,900	11,350	11,450		47.600	(10)
	076	MAHMOUD Jana	12,950	11,800	9,250	11,900		45.900	(14)
	074	ABOELHASAN Jana	12,500	10,400	10,050	11,100		44.050	(17)
	077	SHARAF Zeina		11,200	11,300			22.500	(37)
	078	SWIDAN Nour				11,550		11.550	(42)
<b>Total</b>			(6) 38.350	(7) 34.900	(6) 32.700	(5) 34.900		<b>140.850</b>	
<b>7 SLO - Slovenia</b>									
	100	HRIBAR Lucija	13,000	12,850	11,650	11,650		49.150	(5)
	101	KING Sara	12,000	9,750	9,350	11,300		42.400	(19)
	103	KYSSELEF Tjasa	13,450		11,700			25.150	(34)
	111	TRTNIK Zala		12,400				12.400	(40)
<b>Total</b>			(5) 38.450	(6) 35.000	(7) 32.700	(8) 22.950		<b>129.100</b>	
<b>8 ALG - Algeria</b>									
	062	SALEM Lahna	12,500	11,250	9,250	10,300		43.300	(18)
	064	BOUKHATEM Fatma Zohra	12,300	10,600	8,450	10,350		41.700	(20)
	066	HAMIDI Sihem	12,000	10,050	9,750	8,800		40.600	(22)
	065	NAIR Sofia	DNS	9,300	9,300	9,200		27.800	(29)
<b>Total</b>			(8) 36.800	(8) 31.900	(8) 28.300	(7) 29.850		<b>126.850</b>	





























Report created SUN 26 JUN 2022 21:07:23

Data Processing and Timing by Microplus — [www.microplustiming.com](http://www.microplustiming.com)



## RESULTS

### WOMEN'S QUALIFICATIONS

Rank	Bib	Name	NOC Code	D	E1	E2	E3	E4	E5	E6	E Score	Pen.	Total	Rank by App.		
<b>1</b>	092	MAGGIO Martina	ITA								9,050		<b>13.650</b>	(4)		
					4.600								7,900		<b>13.800</b>	(3)
					5.900								8,350		<b>13.750</b>	(1)
					5.400								7,800		<b>13.500</b>	(1)
		<b>TOTAL :</b>											<b>54.700</b>			
													<b>Q</b>			
<b>2</b>	091	D'AMATO Asia	ITA								8,850		<b>13.850</b>	(1)		
					5.000								7,600		<b>13.600</b>	(5)
					6.000								8,150		<b>13.750</b>	(2)
					5.600								7,800		<b>13.200</b>	(2)
		<b>TOTAL :</b>											<b>54.400</b>			
													<b>Q</b>			
<b>3</b>	087	HEDUIT Carolann	FRA								8,850	-0.10	<b>13.750</b>	(3)		
					5.000								7,500		<b>13.500</b>	(6)
					6.000								7,900		<b>13.500</b>	(3)
					5.600								7,100	-0.10	<b>12.000</b>	(11)
		<b>TOTAL :</b>											<b>52.750</b>			
													<b>Q</b>			
<b>4</b>	086	CHARPY Lorette	FRA								8,950		<b>13.150</b>	(8)		
					4.200								7,950		<b>13.650</b>	(4)
					5.700								7,900		<b>13.200</b>	(6)
					5.300								8,300		<b>11.500</b>	(19)
		<b>TOTAL :</b>											<b>51.500</b>			
													<b>Q</b>			
<b>5</b>	100	HRIBAR Lucija	SLO								8,800		<b>13.000</b>	(10)		
					4.200								8,050		<b>12.850</b>	(7)
					4.800								6,950		<b>11.650</b>	(18)
					4.700								7,350		<b>11.650</b>	(15)
		<b>TOTAL :</b>											<b>49.150</b>			
													<b>Q</b>			
<b>6</b>	080	FERNANDEZ Emma	ESP								8,650		<b>12.850</b>	(16)		
					4.200								6,350		<b>11.450</b>	(20)
					5.100								7,150		<b>12.250</b>	(11)
					5.100								7,250		<b>12.150</b>	(8)
		<b>TOTAL :</b>											<b>48.700</b>			
													<b>Q</b>			
<b>7</b>	108	YILDIZ Bengisu	TUR								8,800		<b>13.000</b>	(9)		
					4.200								7,300		<b>11.800</b>	(17)
					4.500								6,800		<b>11.600</b>	(19)
					4.800								7,150		<b>12.050</b>	(9)
		<b>TOTAL :</b>											<b>48.450</b>			
													<b>Q</b>			





























Report created THU 28 JUN 2022 09:04:05

Data Processing and Timing by Microplus — [www.microplustiming.com](http://www.microplustiming.com)































## RESULTS

### WOMEN'S QUALIFICATIONS

Rank	Bib	Name	NOC Code	D	E1	E2	E3	E4	E5	E6	E Score	Pen.	Total	Rank by App.		
<b>8</b>	079	CASABUENA Laura	ESP								7,500	-0.10	<b>11.600</b>	(29)		
					4.200								6,550		<b>11.550</b>	(19)
					5.000								7,100		<b>12.700</b>	(8)
					5.600								4,900		<b>12.550</b>	(5)
<b>TOTAL : 48.400</b>																
<b>Q</b>																
<b>9</b>	083	PETISCO Alba	ESP								9,000		<b>13.200</b>	(7)		
					4.200								6,750		<b>12.050</b>	(13)
					5.300								5,250		<b>10.650</b>	(25)
					5.400								5,000		<b>12.350</b>	(7)
<b>TOTAL : 48.250</b>																
<b>Q</b>																
<b>10</b>	073	ABDELSALAM Jana	EGY								8,800	-0.10	<b>12.900</b>	(13)		
					4.200								7,100		<b>11.900</b>	(14)
					4.800								6,850	-0.30	<b>11.350</b>	(21)
					4.800								7,050	-0.10	<b>11.450</b>	(21)
<b>TOTAL : 47.600</b>																
<b>Q</b>																
<b>11</b>	106	TARHAN Bilge	TUR								8,700		<b>12.900</b>	(14)		
					4.200								6,850		<b>11.850</b>	(16)
					5.000								6,050		<b>11.250</b>	(24)
					5.200								7,100	-0.10	<b>11.600</b>	(16)
<b>TOTAL : 47.600</b>																
<b>Q</b>																
<b>12</b>	099	PARENTE Mariana	POR								3,600			8,950	<b>12.550</b>	(20)
					3.600								6,350		<b>10.850</b>	(26)
					4.500								7,400		<b>12.000</b>	(14)
					4.600								7,350	-0.10	<b>11.550</b>	(17)
<b>TOTAL : 46.950</b>																
<b>Q</b>																
<b>13</b>	098	SOBRAL Lia	POR								3,600			8,650	<b>12.250</b>	(24)
					3.600								7,100		<b>11.100</b>	(25)
					4.000								6,850		<b>11.250</b>	(23)
					4.400								7,350		<b>11.450</b>	(20)
<b>TOTAL : 46.050</b>																
<b>Q</b>																
<b>14</b>	076	MAHMOUD Jana	EGY								4,400			8,550	<b>12.950</b>	(12)
					4.400								6,900		<b>11.800</b>	(18)
					4.900								4,550		<b>9.250</b>	(33)
					4.700								7,200	-0.20	<b>11.900</b>	(14)
<b>TOTAL : 45.900</b>																
<b>Q</b>																































## RESULTS WOMEN'S QUALIFICATIONS

Rank	Bib	Name	NOC Code	D	E1	E2	E3	E4	E5	E6	E Score	Pen.	Total	Rank by App.		
<b>15</b>	096	COSTA Mafalda	POR								8,650		<b>12.250</b>	(25)		
					3.600								7,200		<b>11.400</b>	(21)
					4.200								6,050		<b>10.550</b>	(26)
					4.500								6,700		<b>11.200</b>	(23)
<b>TOTAL : 45.400</b>																
<b>16</b>	071	BACHURINA Tatiana	CYP								8,450		<b>11.650</b>	(28)		
					3.200								6,300		<b>10.700</b>	(27)
					4.400								7,150		<b>11.750</b>	(16)
					4.600								6,250		<b>10.550</b>	(28)
<b>TOTAL : 44.650</b>																
<b>Q</b>																
<b>17</b>	074	ABOELHASAN Jana	EGY								8,700		<b>12.500</b>	(22)		
					3.800								6,100		<b>10.400</b>	(29)
					4.300								5,550		<b>10.050</b>	(27)
					4.500								7,200	-0.40	<b>11.100</b>	(26)
<b>TOTAL : 44.050</b>																
<b>18</b>	062	SALEM Lahna	ALG								8,900		<b>12.500</b>	(21)		
					3.600								6,950		<b>11.250</b>	(23)
					4.300								5,650		<b>9.250</b>	(32)
					3.600								5,800		<b>10.300</b>	(30)
<b>TOTAL : 43.300</b>																
<b>Q</b>																
<b>19</b>	101	KING Sara	SLO								8,600		<b>12.000</b>	(26)		
					3.400								6,750		<b>9.750</b>	(31)
					3.000								5,550		<b>9.350</b>	(30)
					3.800								7,100		<b>11.300</b>	(22)
<b>TOTAL : 42.400</b>																
<b>Q</b>																
<b>20</b>	064	BOUKHATEM Fatma Zohra	ALG								8,700		<b>12.300</b>	(23)		
					3.600								7,600		<b>10.600</b>	(28)
					3.000								4,650		<b>8.450</b>	(34)
					3.800								6,250		<b>10.350</b>	(29)
<b>TOTAL : 41.700</b>																
<b>Q</b>																
<b>21</b>	072	DIMITRIOU Evangelina	CYP								8,300	-0.10	<b>11.600</b>	(30)		
					3.400								7,300		<b>9.400</b>	(32)
					2.100								5,100		<b>9.800</b>	(28)
					4.700								6,450	-0.30	<b>10.550</b>	(27)
<b>TOTAL : 41.350</b>																
<b>Q</b>																



## RESULTS

### WOMEN'S QUALIFICATIONS

Rank	Bib	Name	NOC Code	D	E1	E2	E3	E4	E5	E6	E Score	Pen.	Total	Rank by App.			
<b>22</b>	066	HAMIDI Sihem	ALG								8,400		<b>12.000</b>	(27)			
					3.600								2.000		8,050	<b>10.050</b>	(30)
						3.300								6,450		<b>9.750</b>	(29)
						3.200								6,300	-0.70	<b>8.800</b>	(32)
<b>23</b>	089	OSYSSEK-REIMER Morgane	FRA								8,700		<b>13.300</b>	(6)			
					4.600								7,800		<b>13.400</b>	(4)	
						5.300							7,650	-0.10	<b>12.850</b>	(4)	
<b>24</b>	109	D'AMATO Alice	ITA								8,800		<b>13.800</b>	(2)			
					5.000								6,750		<b>12.750</b>	(10)	
						5.000							6,500	-0.30	<b>11.200</b>	(24)	
<b>25</b>	093	ANDREOLI Angela	ITA								8,400	-0.30	<b>12.700</b>	(17)			
					4.600								7,100		<b>13.000</b>	(7)	
						5.700							6,600	-0.30	<b>12.000</b>	(12)	
<b>26</b>	107	UCTAS SANLI Goksu	TUR								8,700		<b>12.900</b>	(15)			
					4.200								6,500		<b>11.600</b>	(20)	
						4.800							7,600		<b>12.400</b>	(6)	
<b>27</b>	082	MEDINA Lorena	ESP								8,750		<b>12.950</b>	(11)			
					4.200								7,150		<b>11.850</b>	(15)	
						4.600							7,400		<b>12.000</b>	(10)	
<b>28</b>	104	KAYISOGLU Sevgi	TUR								6,600		<b>11.300</b>	(22)			
					4.700								6,800		<b>11.900</b>	(15)	
						4.800							7,150		<b>11.950</b>	(13)	
<b>29</b>	065	NAIR Sofia	ALG								DNS		DNS	DNS			
													2.100		7,200	<b>9.300</b>	(33)
													4.100		5,200	<b>9.300</b>	(31)
													3.400		5,800	<b>9.200</b>	(31)
<b>30</b>	094	VILLA Giorgia	ITA								8,050		<b>13.850</b>	(1)			
					5.800								8,100		<b>13.200</b>	(5)	

Report created SUN 3 JUL 2022 21:30:38

Data Processing and Timing by Microplus — [www.microplustiming.com](http://www.microplustiming.com)







## RESULTS

### WOMEN'S QUALIFICATIONS

Rank	Bib	Name	NOC Code	D	E1	E2	E3	E4	E5	E6	E Score	Pen.	Total	Rank by App.			
<b>31</b>	097	DA SILVA MARTINS Ana	POR								DNS		DNS				
		<b>TOTAL :</b>											<b>26.300</b>				
		<b>TOTAL :</b>											<b>25.450</b>				
		<b>TOTAL :</b>											<b>25.400</b>				
		<b>TOTAL :</b>											<b>25.150</b>				
		<b>TOTAL :</b>											<b>24.900</b>				
		<b>TOTAL :</b>											<b>23.550</b>				
		<b>TOTAL :</b>											<b>22.500</b>				
		<b>TOTAL :</b>											<b>15.150</b>				
		<b>TOTAL :</b>											<b>12.650</b>				
		<b>TOTAL :</b>											<b>12.400</b>				



## RESULTS WOMEN'S QUALIFICATIONS

Rank	Bib	Name	NOC Code	D	E1	E2	E3	E4	E5	E6	E Score	Pen.	Total	Rank by App.
<b>41</b>	084	VILLALBA Claudia	ESP 	4.500							7,500		<b>12.000</b>	(13)
		<b>TOTAL :</b>											<b>12.000</b>	
<b>42</b>	078	SWIDAN Nour	EGY 	4.300							7,250		<b>11.550</b>	(18)
		<b>TOTAL :</b>											<b>11.550</b>	



## RESULTS

### WOMEN'S QUALIFICATIONS ALL AROUND

Rank	Bib	Name	NOC Code	D	E1	E2	E3	E4	E5	E6	E Score	Pen.	Total	Rank by App.	
<b>1</b>	092	MAGGIO Martina	ITA								9,050		<b>13.650</b>	(4)	
					4.600							7,900		<b>13.800</b>	(3)
					5.900							8,350		<b>13.750</b>	(1)
					5.400							7,800		<b>13.500</b>	(1)
												<b>54.700</b>			
													<b>Q</b>		
<b>2</b>	091	D'AMATO Asia	ITA								8,850		<b>13.850</b>	(1)	
					5.000						7,600		<b>13.600</b>	(5)	
					6.000						8,150		<b>13.750</b>	(2)	
					5.600						7,800		<b>13.200</b>	(2)	
												<b>54.400</b>			
												<b>Q</b>			
<b>3</b>	087	HEDUIT Carolann	FRA								8,850	-0.10	<b>13.750</b>	(3)	
					5.000						7,500		<b>13.500</b>	(6)	
					6.000						7,900		<b>13.500</b>	(3)	
					5.600						7,100	-0.10	<b>12.000</b>	(11)	
												<b>52.750</b>			
												<b>Q</b>			
<b>4</b>	086	CHARPY Lorette	FRA								8,950		<b>13.150</b>	(8)	
					4.200						7,950		<b>13.650</b>	(4)	
					5.700						7,900		<b>13.200</b>	(6)	
					5.300						8,300		<b>11.500</b>	(19)	
												<b>51.500</b>			
												<b>Q</b>			
<b>5</b>	100	HRIBAR Lucija	SLO								4,200		8,800	<b>13.000</b>	(10)
					4.200						4,800		8,050	<b>12.850</b>	(7)
					4.800						4,700		6,950	<b>11.650</b>	(18)
					4.700						4,300		7,350	<b>11.650</b>	(15)
												<b>49.150</b>			
												<b>Q</b>			
<b>6</b>	080	FERNANDEZ Emma	ESP								4,200		8,650	<b>12.850</b>	(16)
					4.200						5,100		6,350	<b>11.450</b>	(20)
					5.100						5,100		7,150	<b>12.250</b>	(11)
					5.100						4,900		7,250	<b>12.150</b>	(8)
												<b>48.700</b>			
												<b>Q</b>			
<b>7</b>	108	YILDIZ Bengisu	TUR								4,200		8,800	<b>13.000</b>	(9)
					4.200						4,500		7,300	<b>11.800</b>	(17)
					4.500						4,800		6,800	<b>11.600</b>	(19)
					4.800						4,900		7,150	<b>12.050</b>	(9)
												<b>48.450</b>			
												<b>Q</b>			



































Report created THU 28 JUN 2022 09:04:05

Data Processing and Timing by Microplus — [www.microplustiming.com](http://www.microplustiming.com)



## RESULTS

### WOMEN'S QUALIFICATIONS ALL AROUND

Rank	Bib	Name	NOC Code	D	E1	E2	E3	E4	E5	E6	E Score	Pen.	Total	Rank by App.	
<b>8</b>	079	CASABUENA Laura	ESP								7,500	-0.10	<b>11.600</b>	(29)	
					4.200							6,550		<b>11.550</b>	(19)
					5.000							7,100		<b>12.700</b>	(8)
					5.600							7,650		<b>12.550</b>	(5)
					4.900										
<b>TOTAL : 48.400</b>															
		<b>Q</b>													
<b>9</b>	083	PETISCO Alba	ESP								9,000		<b>13.200</b>	(7)	
					4.200						6,750		<b>12.050</b>	(13)	
					5.300						5,250		<b>10.650</b>	(25)	
					5.400						7,350		<b>12.350</b>	(7)	
					5.000										
<b>TOTAL : 48.250</b>															
		<b>Q</b>													
<b>10</b>	073	ABDELSALAM Jana	EGY								8,800	-0.10	<b>12.900</b>	(13)	
					4.200						7,100		<b>11.900</b>	(14)	
					4.800						6,850	-0.30	<b>11.350</b>	(21)	
					4.800						7,050	-0.10	<b>11.450</b>	(21)	
					4.500										
<b>TOTAL : 47.600</b>															
		<b>Q</b>													
<b>11</b>	106	TARHAN Bilge	TUR								8,700		<b>12.900</b>	(14)	
					4.200						6,850		<b>11.850</b>	(16)	
					5.000						6,050		<b>11.250</b>	(24)	
					5.200						7,100	-0.10	<b>11.600</b>	(16)	
					4.600										
<b>TOTAL : 47.600</b>															
		<b>Q</b>													
<b>12</b>	099	PARENTE Mariana	POR								8,950		<b>12.550</b>	(20)	
					3.600						6,350		<b>10.850</b>	(26)	
					4.500						7,400		<b>12.000</b>	(14)	
					4.600						7,350	-0.10	<b>11.550</b>	(17)	
					4.300										
<b>TOTAL : 46.950</b>															
		<b>Q</b>													
<b>13</b>	098	SOBRAL Lia	POR								8,650		<b>12.250</b>	(24)	
					3.600						7,100		<b>11.100</b>	(25)	
					4.000						6,850		<b>11.250</b>	(23)	
					4.400						7,350		<b>11.450</b>	(20)	
					4.100										
<b>TOTAL : 46.050</b>															
		<b>Q</b>													
<b>14</b>	076	MAHMOUD Jana	EGY								8,550		<b>12.950</b>	(12)	
					4.400						6,900		<b>11.800</b>	(18)	
					4.900						4,550		<b>9.250</b>	(33)	
					4.700						7,200	-0.20	<b>11.900</b>	(14)	
					4.900										
<b>TOTAL : 45.900</b>															
		<b>Q</b>													





























Report created THU 28 JUN 2022 09:04:05

Data Processing and Timing by Microplus — www.microplustiming.com



## RESULTS

### WOMEN'S QUALIFICATIONS ALL AROUND

Rank	Bib	Name	NOC Code	D	E1	E2	E3	E4	E5	E6	E Score	Pen.	Total	Rank by App.	
<b>15</b>	096	COSTA Mafalda	POR								8,650		<b>12.250</b>	(25)	
					3.600							7,200		<b>11.400</b>	(21)
					4.200							6,050		<b>10.550</b>	(26)
					4.500							6,700		<b>11.200</b>	(23)
<b>TOTAL : 45.400</b>															
<b>16</b>	071	BACHURINA Tatiana	CYP								8,450		<b>11.650</b>	(28)	
					3.200							6,300		<b>10.700</b>	(27)
					4.400							7,150		<b>11.750</b>	(16)
					4.600							6,250		<b>10.550</b>	(28)
<b>TOTAL : 44.650</b>															
<b>Q</b>															
<b>17</b>	074	ABOELHASAN Jana	EGY								8,700		<b>12.500</b>	(22)	
					3.800							6,100		<b>10.400</b>	(29)
					4.300							5,550		<b>10.050</b>	(27)
					4.500							7,200	-0.40	<b>11.100</b>	(26)
<b>TOTAL : 44.050</b>															
<b>18</b>	062	SALEM Lahna	ALG								8,900		<b>12.500</b>	(21)	
					3.600							6,950		<b>11.250</b>	(23)
					4.300							5,650		<b>9.250</b>	(32)
					3.600							5,800		<b>10.300</b>	(30)
<b>TOTAL : 43.300</b>															
<b>Q</b>															
<b>19</b>	101	KING Sara	SLO								8,600		<b>12.000</b>	(26)	
					3.400							6,750		<b>9.750</b>	(31)
					3.000							5,550		<b>9.350</b>	(30)
					3.800							7,100		<b>11.300</b>	(22)
<b>TOTAL : 42.400</b>															
<b>Q</b>															
<b>20</b>	064	BOUKHATEM Fatma Zohra	ALG								8,700		<b>12.300</b>	(23)	
					3.600							7,600		<b>10.600</b>	(28)
					3.000							4,650		<b>8.450</b>	(34)
					3.800							6,250		<b>10.350</b>	(29)
<b>TOTAL : 41.700</b>															
<b>Q</b>															
<b>21</b>	072	DIMITRIOU Evangelina	CYP								8,300	-0.10	<b>11.600</b>	(30)	
					3.400							7,300		<b>9.400</b>	(32)
					2.100							5,100		<b>9.800</b>	(28)
					4.700							6,450	-0.30	<b>10.550</b>	(27)
<b>TOTAL : 41.350</b>															
<b>Q</b>															



## RESULTS

### WOMEN'S QUALIFICATIONS ALL AROUND

Rank	Bib	Name	NOC Code	D	E1	E2	E3	E4	E5	E6	E Score	Pen.	Total	Rank by App.
<b>22</b>	066	HAMIDI Sihem	ALG								8,400		<b>12.000</b>	(27)
		<b>TOTAL :</b>											<b>40.600</b>	
											2,000		8,050	10.050 (30)
											3,300		6,450	9.750 (29)
											3,200		6,300	-0.70 8.800 (32)

Report created SUN 3 JUL 2022 21:30:38

Data Processing and Timing by Microplus — [www.microplustiming.com](http://www.microplustiming.com)



## RESULTS WOMEN'S QUALIFICATIONS VAULT 1

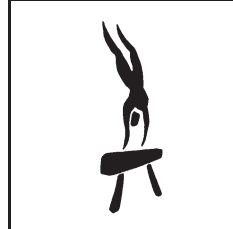

Rank	Bib	Nom Prénom Name Firstname	Fed	D DIF	E1 ITA	E2 POR	E3 SLO	E4 CYP	E5	E6	E Score	Pen.	Total
1.	091	D'AMATO Asia	ITA	5.00							8.85		13.850
2.	109	D'AMATO Alice	ITA	5.00							8.80		13.800
3.	087	HEDUIT Carolann	FRA	5.00							8.85	0.10	13.750
4.	092	MAGGIO Martina	ITA	4.60							9.05		13.650
5.	103	KYSSELEF Tjasa	SLO	4.60							8.85		13.450
6.	089	OSYSSEK-REIMER Morgane	FRA	4.60							8.70		13.300
7.	083	PETISCO Alba	ESP	4.20							9.00		13.200
8.	086	CHARPY Lorette	FRA	4.20							8.95		13.150
9.	108	YILDIZ Bengisu	TUR	4.20							8.80		13.000
9.	100	HRIBAR Lucija	SLO	4.20							8.80		13.000
11.	082	MEDINA Lorena	ESP	4.20							8.75		12.950
12.	076	MAHMOUD Jana	EGY	4.40							8.55		12.950
13.	073	ABDELSALAM Jana	EGY	4.20							8.80	0.10	12.900
14.	106	TARHAN Bilge	TUR	4.20							8.70		12.900
14.	107	UCTAS SANLI Goksu	TUR	4.20							8.70		12.900
16.	080	FERNANDEZ Emma	ESP	4.20							8.65		12.850
17.	093	ANDREOLI Angela	ITA	4.60							8.40	0.30	12.700
18.	070	KORENT Tijana	CRO	3.80							8.85		12.650
19.	105	SAVRANBASI Nazli	TUR	3.80							8.85		12.650
20.	099	PARENTE Mariana	POR	3.60							8.95		12.550
21.	062	SALEM Lahna	ALG	3.60							8.90		12.500
22.	074	ABOELHASAN Jana	EGY	3.80							8.70		12.500
23.	064	BOUKHATEM Fatma Zohra	ALG	3.60							8.70		12.300

Report created MON 27 JUN 2022 21:35:18

Data Processing and Timing by Microplus — www.microplustiming.com



## RESULTS WOMEN'S QUALIFICATIONS VAULT 1

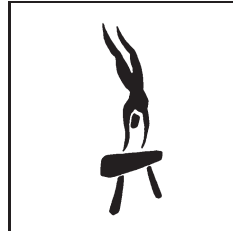

Rank	Bib	Nom Prénom Name Firstname	Fed	D DIF	E1 ITA	E2 POR	E3 SLO	E4 CYP	E5	E6	E Score	Pen.	Total
24.	098	<b>SOBRAL</b> Lia	<b>POR</b>	3.60							8.65		<b>12.250</b>
24.	096	<b>COSTA</b> Mafalda	<b>POR</b>	3.60							8.65		<b>12.250</b>
26.	101	<b>KING</b> Sara	<b>SLO</b>	3.40							8.60		<b>12.000</b>
27.	066	<b>HAMIDI</b> Sihem	<b>ALG</b>	3.60							8.40		<b>12.000</b>
28.	071	<b>BACHURINA</b> Tatiana	<b>CYP</b>	3.20							8.45		<b>11.650</b>
29.	072	<b>DIMITRIOU</b> Evangelina	<b>CYP</b>	3.40							8.30	0.10	<b>11.600</b>
30.	079	<b>CASABUENA</b> Laura	<b>ESP</b>	4.20							7.50	0.10	<b>11.600</b>
31.	095	<b>RAMA</b> Valeza	<b>KOS</b>	3.20							7.05	0.10	<b>10.150</b>
32.	065	<b>NAIR</b> Sofia	<b>ALG</b>	DNS							DNS		DNS
33.	090	<b>SERBER</b> Celia	<b>FRA</b>	DNS							DNS		DNS
33.	097	<b>DA SILVA MARTINS</b> Ana	<b>POR</b>	DNS							DNS		DNS





## RESULTS WOMEN'S VAULT QUALIFICATION

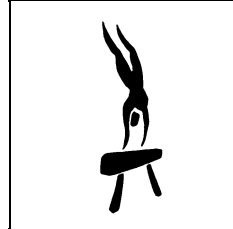

Rank	Bib	Nom Prénom Name Firstname	Fed	D DIF	E1 ITA	E2 POR	E3 SLO	E4 CYP	E5	E6	E Score	Pen.	Total		
1.	091	D'AMATO Asia	ITA	5,00							8.85		13,850	13.800	Q
				4,80							8.95		13,750		
2.	103	KYSSELEF Tjasa	SLO	4,60							8.85		13,450	13.225	Q
				4,20							8.80		13,000		
3.	089	OSYSSEK-REIMER Morgane	FRA	4,60							8.70		13,300	13.000	Q
				4,40							8.30		12,700		
4.	070	KORENT Tijana	CRO	3,80							8.85		12,650	12.750	Q
				4,20							8.65		12,850		
5.	076	MAHMOUD Jana	EGY	4,40							8.55		12,950	12.725	Q
				4,00							8.50		12,500		
6.	093	ANDREOLI Angela	ITA	4,60							8.40	0.30	12,700	12.675	Q
				4,00							8.65		12,650		
7.	108	YILDIZ Bengisu	TUR	4,20							8.80		13,000	12.650	Q
				3,80							8.50		12,300		
8.	106	TARHAN Bilge	TUR	4,20							8.70		12,900	12.650	Q
				4,00							8.40		12,400		
9.	082	MEDINA Lorena	ESP	4,20							8.75		12,950	12.575	R1
				3,60							8.60		12,200		
10.	099	PARENTE Mariana	POR	3,60							8.95		12,550	12.250	R2
				3,40							8.55		11,950		
11.	079	CASABUENA Laura	ESP	4,20							7.50	0.10	11,600	11.825	
				3,40							8.65		12,050		



## RESULTS WOMEN'S UNEVEN BARS QUALIFICATION

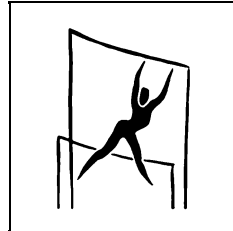

Rank	Bib	Nom Prénom Name Firstname	Fed	D DIF	E1 ESP	E2 EGY	E3 SLO	E4 TUR	E5	E6	E Score	Pen.	Total
1.	094	VILLA Giorgia	ITA	5,80							8.05		13.850 Q
2.	097	DA SILVA MARTINS Ana	POR	6,20							7.65		13.850 Q
3.	092	MAGGIO Martina	ITA	5,90							7.90		13.800 Q
4.	086	CHARPY Lorette	FRA	5,70							7.95		13.650 Q
5.	091	D'AMATO Asia	ITA	6,00							7.60		13.600
6.	087	HEDUIT Carolann	FRA	6,00							7.50		13.500 Q
7.	100	HRIBAR Lucija	SLO	4,80							8.05		12.850 Q
8.	090	SERBER Celia	FRA	5,60							7.20		12.800
9.	105	SAVRANBASI Nazli	TUR	5,20							7.55		12.750 Q
10.	109	D'AMATO Alice	ITA	6,00							6.75		12.750
11.	111	TRTNIK Zala	SLO	4,40							8.00		12.400 Q
12.	088	LAROUI Djenna	FRA	5,30							7.05		12.350
13.	083	PETISCO Alba	ESP	5,30							6.75		12.050 R1
14.	073	ABDELSALAM Jana	EGY	4,80							7.10		11.900 R2
15.	082	MEDINA Lorena	ESP	4,70							7.15		11.850
16.	106	TARHAN Bilge	TUR	5,00							6.85		11.850
17.	108	YILDIZ Bengisu	TUR	4,50							7.30		11.800
18.	076	MAHMOUD Jana	EGY	4,90							6.90		11.800
19.	079	CASABUENA Laura	ESP	5,00							6.55		11.550
20.	080	FERNANDEZ Emma	ESP	5,10							6.35		11.450
21.	096	COSTA Mafalda	POR	4,20							7.20		11.400
22.	104	KAYISOGLU Sevgi	TUR	4,70							6.60		11.300
23.	062	SALEM Lahna	ALG	4,30							6.95		11.250

Report created SUN 26 JUN 2022 21:26:07

Data Processing and Timing by Microplus — www.microplustiming.com



## RESULTS WOMEN'S UNEVEN BARS QUALIFICATION

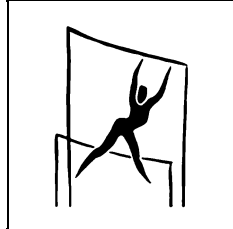

Rank	Bib	Nom Prénom Name Firstname	Fed	D DIF	E1 ESP	E2 EGY	E3 SLO	E4 TUR	E5	E6	E Score	Pen.	Total
24.	077	SHARAF Zeina	EGY	4,80							6.40		11.200
25.	098	SOBRAL Lia	POR	4,00							7.10		11.100
26.	099	PARENTE Mariana	POR	4,50							6.35		10.850
27.	071	BACHURINA Tatiana	CYP	4,40							6.30		10.700
28.	064	BOUKHATEM Fatma Zohra	ALG	3,00							7.60		10.600
29.	074	ABOELHASAN Jana	EGY	4,30							6.10		10.400
30.	066	HAMIDI Sihem	ALG	2,00							8.05		10.050
31.	101	KING Sara	SLO	3,00							6.75		9.750
32.	072	DIMITRIOU Evangelina	CYP	2,10							7.30		9.400
33.	065	NAIR Sofia	ALG	2,10							7.20		9.300
34.	095	RAMA Valeza	KOS	DNS							DNS		DNS



## RESULTS WOMEN'S BEAM QUALIFICATION

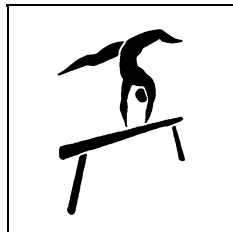

Rank	Bib	Nom Prénom Name Firstname	Fed	D DIF	E1 ITA	E2 POR	E3 SLO	E4 CYP	E5	E6	E Score	Pen.	Total
1.	092	MAGGIO Martina	ITA	5,40							8.35		13.750 Q
2.	091	D'AMATO Asia	ITA	5,60							8.15		13.750 Q
3.	087	HEDUIT Carolann	FRA	5,60							7.90		13.500 Q
4.	089	OSYSSEK-REIMER Morgane	FRA	5,60							7.80		13.400 Q
5.	094	VILLA Giorgia	ITA	5,10							8.10		13.200
6.	086	CHARPY Lorette	FRA	5,30							7.90		13.200
7.	093	ANDREOLI Angela	ITA	5,90							7.10		13.000
8.	079	CASABUENA Laura	ESP	5,60							7.10		12.700 Q
9.	069	DEREK Ana	CRO	5,30							7.20		12.500 Q
10.	097	DA SILVA MARTINS Ana	POR	4,90							7.55		12.450 Q
11.	080	FERNANDEZ Emma	ESP	5,10							7.15		12.250 Q
12.	090	SERBER Celia	FRA	4,90							7.20		12.100
13.	084	VILLALBA Claudia	ESP	4,50							7.50		12.000
14.	099	PARENTE Mariana	POR	4,60							7.40		12.000 R1
15.	104	KAYISOGLU Sevgi	TUR	5,10							6.80		11.900 R2
16.	071	BACHURINA Tatiana	CYP	4,60							7.15		11.750
17.	103	KYSSELEF Tjasa	SLO	4,70							7.00		11.700
18.	100	HRIBAR Lucija	SLO	4,70							6.95		11.650
19.	108	YILDIZ Bengisu	TUR	4,80							6.80		11.600
20.	107	UCTAS SANLI Goksu	TUR	5,10							6.50		11.600
21.	073	ABDELSALAM Jana	EGY	4,80							6.85		11.350
22.	077	SHARAF Zeina	EGY	4,70							6.60		11.300
23.	098	SOBRAL Lia	POR	4,40							6.85		11.250

Report created MON 27 JUN 2022 20:44:30

Data Processing and Timing by Microplus — www.microplustiming.com



## RESULTS WOMEN'S BEAM QUALIFICATION

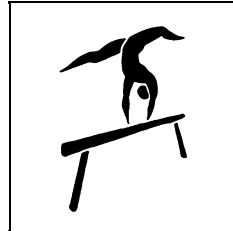

Rank	Bib	Nom Prénom Name Firstname	Fed	D DIF	E1 ITA	E2 POR	E3 SLO	E4 CYP	E5	E6	E Score	Pen.	Total
24.	106	TARHAN Bilge	TUR	5,20							6.05		11.250
25.	083	PETISCO Alba	ESP	5,40							5.25		10.650
26.	096	COSTA Mafalda	POR	4,50							6.05		10.550
27.	074	ABOELHASAN Jana	EGY	4,50							5.55		10.050
28.	072	DIMITRIOU Evangelina	CYP	4,70							5.10		9.800
29.	066	HAMIDI Sihem	ALG	3,30							6.45		9.750
30.	101	KING Sara	SLO	3,80							5.55		9.350
31.	065	NAIR Sofia	ALG	4,10							5.20		9.300
32.	062	SALEM Lahna	ALG	3,60							5.65		9.250
33.	076	MAHMOUD Jana	EGY	4,70							4.55		9.250
34.	064	BOUKHATEM Fatma Zohra	ALG	3,80							4.65		8.450



## RESULTS WOMEN'S FLOOR EXERCISE QUALIFICATION



Rank	Bib	Nom Prénom Name Firstname	Fed	D DIF	E1 ESP	E2 EGY	E3 SLO	E4 TUR	E5	E6	E Score	Pen.	Total
1.	092	MAGGIO Martina	ITA	5,70							7.80		13.500 Q
2.	091	D'AMATO Asia	ITA	5,40							7.80		13.200 Q
3.	069	DEREK Ana	CRO	5,10							7.85		12.950 Q
4.	089	OSYSSEK-REIMER Morgane	FRA	5,30							7.65	0.10	12.850 Q
5.	079	CASABUENA Laura	ESP	4,90							7.65		12.550 Q
6.	107	UCTAS SANLI Goksu	TUR	4,80							7.60		12.400 Q
7.	083	PETISCO Alba	ESP	5,00							7.35		12.350 Q
8.	080	FERNANDEZ Emma	ESP	4,90							7.25		12.150
9.	108	YILDIZ Bengisu	TUR	4,90							7.15		12.050 Q
10.	082	MEDINA Lorena	ESP	4,60							7.40		12.000
11.	087	HEDUIT Carolann	FRA	5,00							7.10	0.10	12.000 R1
12.	093	ANDREOLI Angela	ITA	5,70							6.60	0.30	12.000
13.	104	KAYISOGLU Sevgi	TUR	4,80							7.15		11.950
14.	076	MAHMOUD Jana	EGY	4,90							7.20	0.20	11.900 R1
15.	100	HRIBAR Lucija	SLO	4,30							7.35		11.650
16.	106	TARHAN Bilge	TUR	4,60							7.10	0.10	11.600
17.	099	PARENTE Mariana	POR	4,30							7.35	0.10	11.550
18.	078	SWIDAN Nour	EGY	4,30							7.25		11.550
19.	086	CHARPY Lorette	FRA	3,20							8.30		11.500
20.	098	SOBRAL Lia	POR	4,10							7.35		11.450
21.	073	ABDELSALAM Jana	EGY	4,50							7.05	0.10	11.450
22.	101	KING Sara	SLO	4,20							7.10		11.300
23.	096	COSTA Mafalda	POR	4,50							6.70		11.200

Report created MON 27 JUN 2022 20:44:58

Data Processing and Timing by Microplus — [www.microplustiming.com](http://www.microplustiming.com)



## RESULTS WOMEN'S FLOOR EXERCISE QUALIFICATION



Rank	Bib	Nom Prénom Name Firstname	Fed	D DIF	E1 ESP	E2 EGY	E3 SLO	E4 TUR	E5	E6	E Score	Pen.	Total
24.	109	D'AMATO Alice	ITA	5.00							6.50	0.30	11.200
25.	088	LAROUI Djenna	FRA	4.70							6.50		11.200
26.	074	ABOELHASAN Jana	EGY	4.30							7.20	0.40	11.100
27.	072	DIMITRIOU Evangelina	CYP	4.40							6.45	0.30	10.550
28.	071	BACHURINA Tatiana	CYP	4.30							6.25		10.550
29.	064	BOUKHATEM Fatma Zohra	ALG	4.10							6.25		10.350
30.	062	SALEM Lahna	ALG	4.50							5.80		10.300
31.	065	NAIR Sofia	ALG	3.40							5.80		9.200
32.	066	HAMIDI Sihem	ALG	3.20							6.30	0.70	8.800
33.	095	RAMA Valeza	KOS	2.90							2.10		5.000
34.	097	DA SILVA MARTINS Ana	POR	DNS							DNS		DNS



**Tie Break Report - women's qualifications  
All Around**

Rk	Bib	Name	NOC Code	Total	Sum of best scores											
					6	5	4	3	2	1						
10	073	ABDELSALAM Jana	TUR	47.600	Sum of best scores	36.350					Sum of execution scores					
					Sum of difficulty scores											
11	106	TARHAN Bilge	TUR	47.600	Sum of best scores	36.250					Sum of execution scores					
					Sum of difficulty scores											





### Tie Break Report - women's qualifications



### Vault Qualification

Rank	Bib	Name	NOC Code	Total	Highest Vault	Highest Execution Score	Highest Difficulty Score
7	108	YILDIZ Bengisu	TUR	12.650	13.000		
8	106	TARHAN Bilge	TUR	12.650	12.900		



### Tie Break Report - women's qualifications



#### Uneven Bars

Rank	Bib	Name	NOC Code	Total	Execution Score	Difficulty Score
1	094	VILLA Giorgia	ITA	13.850	8.05	
2	097	DA SILVA MARTINS Ana	POR	13.850	7.65	
9	105	SAVRANBASI Nazli	TUR	12.750	7.55	
10	109	D'AMATO Alice	ITA	12.750	6.75	
17	108	YILDIZ Bengisu	TUR	11.800	7.30	
18	076	MAHMOUD Jana	EGY	11.800	6.90	



### Tie Break Report - women's qualifications



#### Beam

Rank	Bib	Name	NOC Code	Total	Execution Score	Difficulty Score
1	092	MAGGIO Martina	ITA	13.750	8.35	
2	091	D'AMATO Asia	ITA	13.750	8.15	
5	094	VILLA Giorgia	ITA	13.200	8.10	
6	086	CHARPY Lorette	FRA	13.200	7.90	
19	108	YILDIZ Bengisu	TUR	11.600	6.80	
20	107	UCTAS SANLI Goksu	TUR	11.600	6.50	
32	062	SALEM Lahna	ALG	9.250	5.65	
33	076	MAHMOUD Jana	EGY	9.250	4.55	



### Tie Break Report - women's qualifications



#### Floor

Rank	Bib	Name	NOC Code	Total	Execution Score	Difficulty Score
10	082	MEDINA Lorena	ESP	12.000	7.40	
11	087	HEDUIT Carolann	FRA	12.000	7.10	
17	099	PARENTE Mariana	POR	11.550	7.35	
18	078	SWIDAN Nour	EGY	11.550	7.25	
20	098	SOBRAL Lia	POR	11.450	7.35	
21	073	ABDELSALAM Jana	EGY	11.450	7.25	
23	096	COSTA Mafalda	POR	11.200	6.70	
24	109	D'AMATO Al ice	ITA	11.200	6.50	5.00
25	088	LAROUI Djenna	FRA	11.200	6.50	4.70
27	072	DIMITRIOU Evangelina	CYP	10.550	6.45	
28	071	BACHURINA Tatiana	CYP	10.550	6.25	



## List of Qualifiers Women's All-Around Final

Qualifying Order	Bib	Name	NOC Code	Qualification Score
1	092	MAGGIO Martina	ITA	54,700
2	091	D'AMATO Asia	ITA	54,400
3	087	HEDUIT Carolann	FRA	52,750
4	086	CHARPY Lorette	FRA	51,500
5	100	HRIBAR Lucija	SLO	49,150
6	080	FERNANDEZ Emma	ESP	48,700
7	108	YILDIZ Bengisu	TUR	48,450
8	079	CASABUENA Laura	ESP	48,400
9	073	ABDELSALAM Jana	EGY	47,600
10	106	TARHAN Bilge	TUR	47,600
11	099	PARENTE Mariana	POR	46,950
12	098	SOBRAL Lia	POR	46,050
13	076	MAHMOUD Jana	EGY	45,900
14	071	BACHURINA Tatiana	CYP	44,650
15	062	SALEM Lahna	ALG	43,300
16	101	KING Sara	SLO	42,400
17	064	BOUKHATEM Fatma Zohra	ALG	41,700
18	072	DIMITRIOU Evangelina	CYP	41,350



### All Around Final Women Draw

Rotation	Vault	Uneven Bars	Beam	Floor
1	3-2-1-9	12-11-10-18		
	8-7-6-5-4	17-16-15-14-13		
2		2-1-9-8	11-10-18-17	
		7-6-5-4-3	16-15-14-13-12	
3			1-9-8-7	10-18-17-16
			6-5-4-3-2	15-14-13-12-11
4	18-17-16-15			9-8-7-6
	14-13-12-11-10			5-4-3-2-1



## START LIST

Women's Individual All-Around Final

ROTATION 1 of 4

28 June 2022 - 10:00 to 10:30

### VAULT

Bib Name	NOC Code
087 HEDUIT Carolann	FRA
091 D'AMATO Asia	ITA
092 MAGGIO Martina	ITA
074 ABOELHASAN Jana	EGY
079 CASABUENA Laura	ESP
108 YILDIZ Bengisu	TUR
080 FERNANDEZ Emma	ESP
100 HRIBAR Lucija	SLO

### UNEVEN BARS

Bib Name	NOC Code
098 SOBRAL Lia	POR
099 PARENTE Mariana	POR
106 TARHAN Bilge	TUR
072 DIMITRIOU Evangelina	CYP
064 BOUKHATEM Fatma Zohra	ALG
101 KING Sara	SLO
062 SALEM Lahna	ALG
071 BACHURINA Tatiana	CYP
076 MAHMOUD Jana	EGY

### BEAM

Bib Name	NOC Code
----------	----------

### FLOOR

Bib Name	NOC Code
----------	----------



## START LIST

Women's Individual All-Around Final

ROTATION 2 of 4

28 June 2022 - 10:30 to 11:00

### VAULT

Bib Name	NOC Code
----------	----------

### UNEVEN BARS

Bib Name	NOC Code
091 D'AMATO Asia	ITA
092 MAGGIO Martina	ITA
074 ABOELHASAN Jana	EGY
079 CASABUENA Laura	ESP
108 YILDIZ Bengisu	TUR
080 FERNANDEZ Emma	ESP
100 HRIBAR Lucija	SLO
087 HEDUIT Carolann	FRA

### BEAM

Bib Name	NOC Code
099 PARENTE Mariana	POR
106 TARHAN Bilge	TUR
072 DIMITRIOU Evangelina	CYP
064 BOUKHATEM Fatma Zohra	ALG
101 KING Sara	SLO
062 SALEM Lahna	ALG
071 BACHURINA Tatiana	CYP
076 MAHMOUD Jana	EGY
098 SOBRAL Lia	POR

### FLOOR

Bib Name	NOC Code
----------	----------





## START LIST

Women's Individual All-Around Final

ROTATION 3 of 4

28 June 2022 - 11:00 to 11:30

### VAULT

Bib Name	NOC Code
----------	----------

### UNEVEN BARS

Bib Name	NOC Code
----------	----------

### BEAM

Bib Name	NOC Code
092 MAGGIO Martina	ITA
074 ABOELHASAN Jana	EGY
079 CASABUENA Laura	ESP
108 YILDIZ Bengisu	TUR
080 FERNANDEZ Emma	ESP
100 HRIBAR Lucija	SLO
087 HEDUIT Carolann	FRA
091 D'AMATO Asia	ITA

### FLOOR

Bib Name	NOC Code
106 TARHAN Bilge	TUR
072 DIMITRIOU Evangelina	CYP
064 BOUKHATEM Fatma Zohra	ALG
101 KING Sara	SLO
062 SALEM Lahna	ALG
071 BACHURINA Tatiana	CYP
076 MAHMOUD Jana	EGY
098 SOBRAL Lia	POR
099 PARENTE Mariana	POR



## START LIST

Women's Individual All-Around Final

ROTATION 4 of 4

28 June 2022 - 11:30 to 12:00

### VAULT

Bib Name	NOC Code
072 DIMITRIOU Evangelina	CYP
064 BOUKHATEM Fatma Zohra	ALG
101 KING Sara	SLO
062 SALEM Lahna	ALG
071 BACHURINA Tatiana	CYP
076 MAHMOUD Jana	EGY
098 SOBRAL Lia	POR
099 PARENTE Mariana	POR
106 TARHAN Bilge	TUR

### UNEVEN BARS

Bib Name	NOC Code
----------	----------

### BEAM

Bib Name	NOC Code
----------	----------

### FLOOR

Bib Name	NOC Code
074 ABOELHASAN Jana	EGY
079 CASABUENA Laura	ESP
108 YILDIZ Bengisu	TUR
080 FERNANDEZ Emma	ESP
100 HRIBAR Lucija	SLO
087 HEDUIT Carolann	FRA
091 D'AMATO Asia	ITA
092 MAGGIO Martina	ITA



## JUDGES ASSIGNMENT

### XIX Mediterranean Games Oran 2022

28-Jun-22

#### All Around Final



#### Competition Superior Jury

Nehad ZAYED

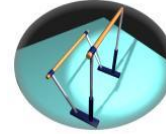
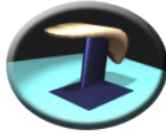

Number	JUDGES			Nation
--------	--------	--	--	--------

Number	JUDGES			Nation
--------	--------	--	--	--------

<b>D1</b>	4	AHMED ELMERIDI	Mariam	EGY
<b>D2</b>	6	MIQUEL	Stephane	FRA
<b>E1</b>	9	CARVALHO	Joana	POR
<b>E2</b>	10	HORVAT	Carmen	SLO
<b>E3</b>	13	DAGISTANLI	SIBEL	TUR
<b>E4</b>	8	CORTIGIANI	Dora	ITA
<b>E5</b>	1	SEBIHI	Ouahiba	ALG
<b>Line</b>	16	BELKHIR	IMENE	ALG

<b>D1</b>	7	COCUZZA	Maria	ITA
<b>D2</b>	2	LEDERER	Dunja	CRO
<b>E1</b>	3	MICHAIL	Elpida	CYP
<b>E2</b>	12	GARCIA BEN	ZELTIA NATIVIDADE	ESP
<b>E3</b>	14	GULER YILMAZ	MERGUL	TUR
<b>E4</b>	5	ASAAD	Heba	EGY
<b>E5</b>	11	PUSNIK	Vika	SLO
<b>Timer</b>	19	IDDIR	LYLIA	ALG

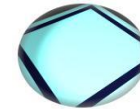
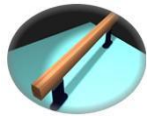

Number	JUDGES			Nation
--------	--------	--	--	--------

Number	JUDGES			Nation
--------	--------	--	--	--------

<b>D1</b>	4	AHMED ELMERIDI	Mariam	EGY
<b>D2</b>	6	MIQUEL	Stephane	FRA
<b>E1</b>	9	CARVALHO	Joana	POR
<b>E2</b>	10	HORVAT	Carmen	SLO
<b>E3</b>	13	DAGISTANLI	SIBEL	TUR
<b>E4</b>	8	CORTIGIANI	Dora	ITA
<b>E5</b>	1	SEBIHI	Ouahiba	ALG
<b>Time 1</b>	16	BELKHIR	IMENE	ALG
<b>Time 2</b>	18	HAMIDI	MAJDA	ALG

<b>D1</b>	7	COCUZZA	Maria	ITA
<b>D2</b>	2	LEDERER	Dunja	CRO
<b>E1</b>	3	MICHAIL	Elpida	CYP
<b>E2</b>	12	GARCIA BEN	ZELTIA NATIVIDADE	ESP
<b>E3</b>	14	GULER YILMAZ	MERGUL	TUR
<b>E4</b>	5	ASAAD	Heba	EGY
<b>E5</b>	11	PUSNIK	Vika	SLO
<b>Time</b>	19	IDDIR	LYLIA	ALG
<b>Line 1</b>	15	KOUIMIA	NEILA	ALG
<b>Line 2</b>	17	BENCHKH	AYA	ALG





0

0



**MEDITERRANEAN GAMES  
ORAN 2022**

**RESULTS  
WOMEN'S ALL-AROUND FINAL**

Rank	Bib	Name	NOC Code					Total
1	092	MAGGIO Martina	ITA	13,666	13,666	13,966	13,566	<b>54,864</b>
2	091	D'AMATO Asia	ITA	14,033	13,833	13,366	12,833	<b>54,065</b>
3	087	HEDUIT Carolann	FRA	13,933	13,666	12,433	13,033	<b>53,065</b>
4	100	HRIBAR Lucija	SLO	13,133	12,433	11,500	11,966	<b>49,032</b>
5	080	FERNANDEZ Emma	ESP	12,766	11,200	12,000	12,400	<b>48,366</b>
6	076	MAHMOUD Jana	EGY	12,933	12,100	10,633	11,766	<b>47,432</b>
7	079	CASABUENA Laura	ESP	12,666	12,500	9,400	12,266	<b>46,832</b>
8	108	YILDIZ Bengisu	TUR	12,833	11,700	10,966	11,333	<b>46,832</b>
9	106	TARHAN Bilge	TUR	12,966	11,733	10,466	10,966	<b>46,131</b>
10	072	DIMITRIOU Evangelina	CYP	11,800	10,066	11,300	11,333	<b>44,499</b>
11	071	BACHURINA Tatiana	CYP	11,666	11,966	10,433	10,400	<b>44,465</b>
12	099	PARENTE Mariana	POR	12,366	11,600	9,733	10,433	<b>44,132</b>
13	101	KING Sara	SLO	11,866	10,466	10,333	11,333	<b>43,998</b>
14	074	ABOELHASAN Jana	EGY	11,933	9,633	9,900	12,133	<b>43,599</b>
15	098	SOBRAL Lia	POR	12,133	9,066	10,666	11,533	<b>43,398</b>
16	064	BOUKHATEM Fatma Zohra	ALG	0,000	10,500	8,533	10,133	<b>29,166</b>







**Tie Break Report - women's qualifications  
All Around Final**

Rk	Bib	Name	NOC Code	Total	Sum of best scores											
					6	5	4	3	2	1						
7	079	CASABUENA Laura	ESP	46.832	Sum of best scores			37.432			Sum of execution scores			Sum of difficulty scores		
8	108	YILDIZ Bengisu	TUR	46.832	Sum of best scores			35.866			Sum of execution scores			Sum of difficulty scores		



## Apparatus Final Women Draw XIX Mediterranean Games Oran 2022

WAG INDIVIDUAL APPARATUS FINALS							
	Ranking after Qualification		Ranking after Qualification		Ranking after Qualification		Ranking after Qualification
1	<b>6</b>	1	<b>7</b>	1	<b>5</b>	1	<b>5</b>
2	<b>2</b>	2	<b>1</b>	2	<b>2</b>	2	<b>1</b>
3	<b>1</b>	3	<b>4</b>	3	<b>1</b>	3	<b>2</b>
4	<b>3</b>	4	<b>3</b>	4	<b>4</b>	4	<b>6</b>
5	<b>4</b>	5	<b>2</b>	5	<b>8</b>	5	<b>4</b>
6	<b>5</b>	6	<b>5</b>	6	<b>3</b>	6	<b>8</b>
7	<b>7</b>	7	<b>8</b>	7	<b>7</b>	7	<b>7</b>
8	<b>8</b>	8	<b>6</b>	8	<b>6</b>	8	<b>3</b>



START LISTS  
WOMEN'S APPARATUS FINALS

REVISED 28 JUN  
17:00



Qualifying Order	Bib Name	NOC Code	Qual. Score
1	093 ANDREOLI Angela	ITA	12,675
2	103 KYSSSELEF Tjasa	SLO	13,225
3	091 D'AMATO Asia	ITA	13,800
4	089 OSYSSEK-REIMER Morgane	FRA	13,000
5	070 KORENT Tijana	CRO	12,750
6	076 MAHMOUD Jana	EGY	12,725
7	108 YILDIZ Bengisu	TUR	12,650
8	106 TARHAN Bilge	TUR	12,650
<b>Reserves</b>			
R1	082 MEDINA Lorena	ESP	12,575
R2	099 PARENTE Mariana	POR	12,250

Qualifying Order	Bib Name	NOC Code	Qual. Score
1	105 SAVRANBASI Nazli	TUR	12,750
2	094 VILLA Giorgia	ITA	13,850
3	090 SERBER Celia	FRA	12,800
4	092 MAGGIO Martina	ITA	13,800
5	097 DA SILVA MARTINS Ana	POR	13,850
6	087 HEDUIT Carolann	FRA	13,500
7	111 TRTNIK Zala	SLO	12,400
8	100 HRIBAR Lucija	SLO	12,850
<b>Reserves</b>			
R1	083 PETISCO Alba	ESP	12,050
R2	073 ABDELSALAM Jana	EGY	11,900



Qualifying Order	Bib Name	NOC Code	Qual. Score
1	079 CASABUENA Laura	ESP	12,700
2	091 D'AMATO Asia	ITA	13,750
3	092 MAGGIO Martina	ITA	13,750
4	089 OSYSSEK-REIMER Morgane	FRA	13,400
5	080 FERNANDEZ Emma	ESP	12,250
6	087 HEDUIT Carolann	FRA	13,500
7	097 DA SILVA MARTINS Ana	POR	12,450
8	069 DEREK Ana	CRO	12,500
<b>Reserves</b>			
R1	099 PARENTE Mariana	POR	12,000
R2	104 KAYISOGLU Sevgi	TUR	11,900

Qualifying Order	Bib Name	NOC Code	Qual. Score
1	079 CASABUENA Laura	ESP	12,550
2	092 MAGGIO Martina	ITA	13,500
3	091 D'AMATO Asia	ITA	13,200
4	107 UCTAS SANLI Goksu	TUR	12,400
5	089 OSYSSEK-REIMER Morgane	FRA	12,850
6	108 YILDIZ Bengisu	TUR	12,050
7	083 PETISCO Alba	ESP	12,350
8	069 DEREK Ana	CRO	12,950
<b>Reserves</b>			
R1	087 HEDUIT Carolann	FRA	12,000
R2	076 MAHMOUD Jana	EGY	11,900

Report created MON 27 JUN 2022 13:22:46

Data Processing and Timing by Microplus — www.microplustiming.com



## JUDGES ASSIGNMENT

### XIX Mediterranean Games Oran 2022

29-Jun-22

#### Apparatus Finals



Competition Superior Jury  
Nehad ZAYED

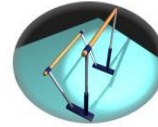
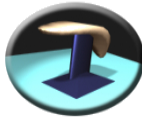

	Number	JUDGES		Nation
<b>D1</b>	4	AHMED ELMERIDI	Mariam	EGY
<b>D2</b>	6	MIQUEL	Stephane	FRA
<b>E1</b>	9	CARVALHO	Joana	POR
<b>E2</b>	12	GARCIA BEN	ZELTIA NATIVIDADE	ESP
<b>E3</b>	3	MICHAIL	Elpida	CYP
<b>E4</b>	1	SEBIHI	Ouahiba	ALG
<b>Line</b>	8	CORTIGIANI	Dora	ITA

	Number	JUDGES		Nation
<b>D1</b>	7	COCUZZA	Maria	ITA
<b>D2</b>	2	LEDERER	Dunja	CRO
<b>E1</b>	12	GARCIA BEN	ZELTIA NATIVIDADE	ESP
<b>E2</b>	1	SEBIHI	Ouahiba	ALG
<b>E3</b>	5	ASAAD	Heba	EGY
<b>E4</b>	3	MICHAIL	Elpida	CYP
<b>Timer</b>	13	DAGISTANLI	SIBEL	TUR

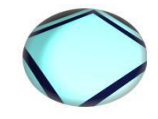
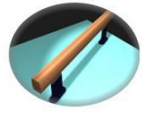

	Number	JUDGES		Nation
<b>D1</b>	4	AHMED ELMERIDI	Mariam	EGY
<b>D2</b>	6	MIQUEL	Stephane	FRA
<b>E1</b>	3	MICHAIL	Elpida	CYP
<b>E2</b>	11	PUSNIK	Vika	SLO
<b>E3</b>	14	GULER YILMAZ	MERGUL	TUR
<b>E4</b>	1	SEBIHI	Ouahiba	ALG
<b>Time 1</b>	12	GARCIA BEN	ZELTIA NATIVIDADE	ESP
<b>Time 2</b>	9	CARVALHO	Joana	POR

	Number	JUDGES		Nation
<b>D1</b>	7	COCUZZA	Maria	ITA
<b>D2</b>	2	LEDERER	Dunja	CRO
<b>E1</b>	10	HORVAT	Carmen	SLO
<b>E2</b>	9	CARVALHO	Joana	POR
<b>E3</b>	1	SEBIHI	Ouahiba	ALG
<b>E4</b>	3	MICHAIL	Elpida	CYP
<b>Time</b>	13	DAGISTANLI	SIBEL	TUR
<b>Line 1</b>	12	GARCIA BEN	ZELTIA NATIVIDADE	ESP
<b>Line 2</b>	5	ASAAD	Heba	EGY





## INDIVIDUAL JUDGES SCORES WOMEN'S VAULT FINAL

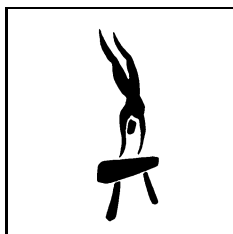

Rank	Bib	Name	NOC Code	D Score	E1	E2	E3	E4	E Score	Pen.	Total
1	091	D'AMATO Asia	ITA	1	5.000				8,850		13,850
				2	4.800				9,100		13,900
2	089	OSYSSEK-REIMER Morgane	FRA	1	4.600				9,000		13,600
				2	4.400				8,800		13,200
3	093	ANDREOLI Angela	ITA	1	4.600				9,100		13,700
				2	3.800				8,900		12,700
4	103	KYSSELEF Tjasa	SLO	1	4.600				8,800		13,400
				2	4.200				8,800		13,000
5	070	KORENT Tijana	CRO	1	4.200				8,600		12,800
				2	4.200				8,800		13,000
6	076	MAHMOUD Jana	EGY	1	4.400				8,550		12,950
				2	4.000				8,700		12,700
7	106	TARHAN Bilge	TUR	1	4.200				8,800		13,000
				2	4.000				8,400		12,400
8	108	YILDIZ Bengisu	TUR	1	4.200				8,400		12,600
				2	3.800				8,200		12,000



## RESULTS

### WOMEN'S UNEVEN BARS FINAL

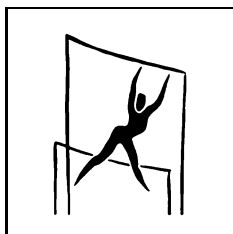

Rank	Bib	Name	NOC Code	D Score	E Score	Pen.	Total
1	094	VILLA Giorgia	ITA	5.800	8,200		<b>14,000</b>
2	092	MAGGIO Martina	ITA	6.000	7,850		<b>13,850</b>
3	097	DA SILVA MARTINS Ana	POR	6.200	7,650		<b>13,850</b>
4	100	HRIBAR Lucija	SLO	5.000	8,150		<b>13,150</b>
5	111	TRTNIK Zala	SLO	4.400	8,200		<b>12,600</b>
6	087	HEDUIT Carolann	FRA	5.800	6,600		<b>12,400</b>
7	090	SERBER Celia	FRA	5.300	6,950		<b>12,250</b>
8	105	SAVRANBASI Nazli	TUR	4.700	5,500		<b>10,200</b>



## RESULTS WOMEN'S BEAM FINAL

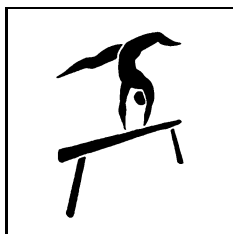

Rank	Bib	Name	NOC Code	D Score	E Score	Pen.	Total
1	092	MAGGIO Martina	ITA	5.600	7,950		<b>13,550</b>
2	091	D'AMATO Asia	ITA	5.600	7,650		<b>13,250</b>
3	087	HEDUIT Carolann	FRA	5.500	7,600		<b>13,100</b>
4	089	OSYSSEK-REIMER Morgane	FRA	5.600	7,250	<b>-0.10</b>	<b>12,750</b>
5	079	CASABUENA Laura	ESP	5.900	6,750		<b>12,650</b>
6	069	DEREK Ana	CRO	5.200	7,400		<b>12,600</b>
7	097	DA SILVA MARTINS Ana	POR	5.200	6,200		<b>11,400</b>
8	080	FERNANDEZ Emma	ESP	5.100	5,300		<b>10,400</b>



## RESULTS WOMEN'S FLOOR EXERCISE FINAL

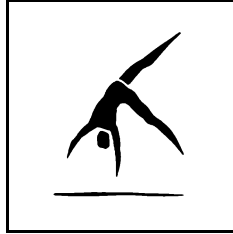

Rank	Bib	Name	NOC Code	D Score	E Score	Pen.	Total
1	091	D'AMATO Asia	ITA	5.500	8,000		<b>13,500</b>
2	092	MAGGIO Martina	ITA	5.600	7,700		<b>13,300</b>
3	089	OSYSSEK-REIMER Morgane	FRA	5.200	7,850		<b>13,050</b>
4	107	UCTAS SANLI Goksu	TUR	5.000	8,000		<b>13,000</b>
5	083	PETISCO Alba	ESP	5.000	7,950		<b>12,950</b>
6	069	DEREK Ana	CRO	5.200	7,650		<b>12,850</b>
7	079	CASABUENA Laura	ESP	4.900	7,400		<b>12,300</b>
8	108	YILDIZ Bengisu	TUR	5.000	6,450		<b>11,450</b>



### Tie Break Report - women's qualifications



#### Vault Qualification

Rank	Bib	Name	NOC Code	Total	Highest Vault	Highest Execution Score	Highest Difficulty Score
3	093	ANDREOLI Angela	ITA	13.200	13.700		
4	103	KYSSELEF Tjasa	SLO	13.200	13.400		



#### Uneven Bars

Rank	Bib	Name	NOC Code	Total	Execution Score	Difficulty Score
2	092	MAGGIO Martina	ITA	13.850	7.850	
3	097	DA SILVA MARTINS Ana	POR	13.850	7.650	



## ENTRY LIST BY NOC

As of MON 27 JUL 2022

NOC		Number of Gymnasts
<b>ALB</b>	Albania	<b>1</b>
<b>ALG</b>	Algeria	<b>5</b>
<b>BIH</b>	Bosnie-Herzégovine	<b>1</b>
<b>CRO</b>	Croatia	<b>3</b>
<b>CYP</b>	Cyprus	<b>5</b>
<b>EGY</b>	Egypt	<b>5</b>
<b>ESP</b>	Spain	<b>5</b>
<b>FRA</b>	France	<b>5</b>
<b>GRE</b>	Greece	<b>5</b>
<b>ITA</b>	Italy	<b>5</b>
<b>KOS</b>	Kosovo	<b>1</b>
<b>MON</b>	Monaco	<b>1</b>
<b>POR</b>	Portugal	<b>4</b>
<b>SLO</b>	Slovenia	<b>2</b>
<b>SRB</b>	Serbia	<b>2</b>
<b>SYR</b>	Syrian Arab Rep.	<b>3</b>
<b>TUR</b>	Turkiye	<b>5</b>
<b>17</b>		<b>58</b>



## ENTRY LIST BY BIB NUMBER

As of MON 27 JUL 2022

Bib	FIG License number	Name	NOC	Year of Birth
1	46727	PETROV Matvei	ALB	1990
2	13667	METIDJI Hillal	ALG	1992
3	16179	BOURGUIEG Mohamed Abdeldjalil	ALG	1996
4	21403	YOUSFI Mohamed Amine	ALG	1996
5	45086	DJABER Hmida	ALG	2003
6	46015	BELLAOUI Bilal	ALG	2003
7	33320	MALIC CORNI Sergej	BIH	2006
8	21548	SRBIC Tin	CRO	1996
9	23382	VLAHEK Jakov	CRO	1997
10	35515	ZUGEC Mateo	CRO	2002
11	43104	ANGONAS Georgios	CYP	2003
12	44697	CHARI Michalis	CYP	2002
13	21180	GEORGIOU Marios	CYP	1997
14	29890	GEORGIOU Ilias	CYP	1999
16	36657	PILAKOURIS Sokratis	CYP	1999
17	19697	ABDELRAHMAN Ahmed	EGY	2000
18	16152	ZAHARAN Ali	EGY	1989
19	15851	ELMARAGHY Ahmed	EGY	1996
20	35621	KHATER Zaid	EGY	2001
21	34217	MOHAMED Omar	EGY	1999
22	9877	ABAD Nestor	ESP	1993
23	34824	DIALLO Thierno	ESP	2000
24	32495	MIR Nicolau	ESP	2000
25	21410	PLATA Joel	ESP	1998
27	53464	WILLIAMS Joshua Jack	ESP	2000
28	25189	BERNARD Cameron-Lie	FRA	1998
29	19165	BOULET Edgar	FRA	1995
31	16978	PHILIPPE Mathias	FRA	1993
32	38078	SALADINO Leo	FRA	2002
33	48897	SALEUR Julien	FRA	1991
34	10984	ILIOPOULOS Nikolaos	GRE	1993
35	36160	KANELLOS Apostolos	GRE	2000
36	11002	KONSTANTINIDIS Christoforos	GRE	1993
37	21560	TANTALIDIS Antonios	GRE	1997
38	36180	TSOLAKIDIS Stefanos	GRE	2000
39	16155	BARTOLINI Nicola	ITA	1996
40	37949	CASALI Lorenzo Minh	ITA	2002
41	18106	LEVANTESI Matteo	ITA	1997
42	14914	LODADIO Marco	ITA	1992
44	55514	CITAKU Elvis	KOS	2003
45	16003	CROVETTO Kevin	MON	1992
46	40971	CAMPOS Guilherme	POR	2000

Report created FRI 1 JUL 2022 16:37:54

Data Processing and Timing by Microplus — [www.microplustiming.com](http://www.microplustiming.com)



## ENTRY LIST BY BIB NUMBER

As of MON 27 JUL 2022

Bib	FIG License number	Name	NOC	Year of Birth
47	40989	MARQUES Marcelo	POR	2001
48	40987	ALMEIDA Filipe	POR	2002
49	40969	NOGUEIRA Jose	POR	2002
50	24436	VEFIC Petar	SRB	1999
51	24479	DEJANOVIC Ivan	SRB	1999
52	46465	BOZIC Nikolaj	SLO	2002
53	23733	BOJANC Luka	SLO	1997
54	40936	AL SOULIMAN Yazan	SYR	2000
55	38411	KHALIL Mohamad	SYR	1999
56	37644	NAJJAR Lais	SYR	2002
57	12985	ARICAN Ferhat	TUR	1993
58	30933	ASIL Adem	TUR	1999
59	15842	COLAK Ibrahim	TUR	1995
60	33061	DEMIR Sercan	TUR	1999
61	16021	ONDER Ahmet	TUR	1996
112	35223	GIANNINI Lay	ITA	2001





## START LIST

Men's Qualifications and Team Final  
SUBDIVISION 1 of 2 - ROTATION 1 of 6  
27 June 2022 - 15:00 to 15:30

### FLOOR

Bib Name	NOC
005 DJABER Hmida	ALG
002 METIDJI Hillal	ALG
003 BOURGUIEG Mohamed Abdeldjalil	ALG
006 BELLAOUI Bilal	ALG
009 VLAHEK Jakov	CRO
001 PETROV Matvei	ALB

### POMMELS HORSE

Bib Name	NOC
020 KHATER Zaid	EGY
021 MOHAMED Omar	EGY
017 ABDELRAHMAN Ahmed	EGY
045 CROVETTO Kevin	MON
050 VEFIC Petar	SRB

### RINGS

Bib Name	NOC
046 CAMPOS Guilherme	POR
049 NOGUEIRA Jose	POR
048 ALMEIDA Filipe	POR
047 MARQUES Marcelo	POR
056 NAJJAR Lais	SYR
054 AL SOULIMAN Yazan	SYR
044 CITAKU Elvis	KOS

### VAULT

Bib Name	NOC
----------	-----

### PARALLEL BARS

Bib Name	NOC
----------	-----

### HORIZONTAL BAR

Bib Name	NOC
----------	-----



## START LIST

Men's Qualifications and Team Final  
SUBDIVISION 1 of 2 - ROTATION 2 of 6  
27 June 2022 - 15:30 to 16:00

### FLOOR

Bib Name	NOC
----------	-----

### POMMELS HORSE

Bib Name	NOC
005 DJABER Hmida	ALG
002 METIDJI Hillal	ALG
004 YOUSFI Mohamed Amine	ALG
003 BOURGUIEG Mohamed Abdeldjalil	ALG
010 ZUGEC Mateo	CRO
001 PETROV Matvei	ALB
009 VLAHEK Jakov	CRO

### RINGS

Bib Name	NOC
017 ABDELRAHMAN Ahmed	EGY
021 MOHAMED Omar	EGY
020 KHATER Zaid	EGY
018 ZAHARAN Ali	EGY
050 VEFIC Petar	SRB
045 CROVETTO Kevin	MON

### VAULT

Bib Name	NOC
046 CAMPOS Guilherme	POR *
049 NOGUEIRA Jose	POR *
048 ALMEIDA Filipe	POR *
047 MARQUES Marcelo	POR
054 AL SOULIMAN Yazan	SYR
055 KHALIL Mohamad	SYR
007 MALIC CORNI Sergej	BIH
044 CITAKU Elvis	KOS
056 NAJJAR Lais	SYR *

### PARALLEL BARS

Bib Name	NOC
----------	-----

### HORIZONTAL BAR

Bib Name	NOC
----------	-----



## START LIST

Men's Qualifications and Team Final  
SUBDIVISION 1 of 2 - ROTATION 3 of 6  
27 June 2022 - 16:00 to 16:30

### FLOOR

Bib Name	NOC
----------	-----

### POMMELS HORSE

Bib Name	NOC
----------	-----

### RINGS

Bib Name	NOC
005 DJABER Hmida	ALG
002 METIDJI Hillal	ALG
006 BELLAOUI Bilal	ALG
003 BOURGUIEG Mohamed Abdeldjalil	ALG
001 PETROV Matvei	ALB
009 VLAHEK Jakov	CRO

### VAULT

Bib Name	NOC
021 MOHAMED Omar	EGY *
017 ABDELRAHMAN Ahmed	EGY
020 KHATER Zaid	EGY
045 CROVETTO Kevin	MON
050 VEFIC Petar	SRB *

### PARALLEL BARS

Bib Name	NOC
048 ALMEIDA Filipe	POR
046 CAMPOS Guilherme	POR
049 NOGUEIRA Jose	POR
047 MARQUES Marcelo	POR
055 KHALIL Mohamad	SYR
044 CITAKU Elvis	KOS
056 NAJJAR Lais	SYR
054 AL SOULIMAN Yazan	SYR

### HORIZONTAL BAR

Bib Name	NOC
----------	-----



## START LIST

Men's Qualifications and Team Final  
SUBDIVISION 1 of 2 - ROTATION 4 of 6  
27 June 2022 - 16:30 to 17:00

### FLOOR

### POMMELS HORSE

Bib Name	NOC
----------	-----

Bib Name	NOC
----------	-----

### RINGS

### VAULT

Bib Name	NOC
----------	-----

Bib Name	NOC
----------	-----

005 DJABER Hmida	ALG
006 BELLAOUI Bilal	ALG
002 METIDJI Hillal	ALG
003 BOURGUIEG Mohamed Abdeldjalil	ALG
001 PETROV Matvei	ALB
009 VLAHEK Jakov	CRO

### PARALLEL BARS

### HORIZONTAL BAR

Bib Name	NOC
----------	-----

Bib Name	NOC
----------	-----

017 ABDELRAHMAN Ahmed	EGY
020 KHATER Zaid	EGY
021 MOHAMED Omar	EGY
045 CROVETTO Kevin	MON
050 VEFIC Petar	SRB

048 ALMEIDA Filipe	POR
046 CAMPOS Guilherme	POR
049 NOGUEIRA Jose	POR
047 MARQUES Marcelo	POR
044 CITAKU Elvis	KOS
056 NAJJAR Lais	SYR
054 AL SOULIMAN Yazan	SYR



## START LIST

Men's Qualifications and Team Final  
SUBDIVISION 1 of 2 - ROTATION 5 of 6  
27 June 2022 - 17:00 to 17:30

### FLOOR

Bib Name	NOC
048 ALMEIDA Filipe	POR
046 CAMPOS Guilherme	POR
049 NOGUEIRA Jose	POR
047 MARQUES Marcelo	POR
044 CITAKU Elvis	KOS
056 NAJJAR Lais	SYR
054 AL SOULIMAN Yazan	SYR
055 KHALIL Mohamad	SYR

### POMMELS HORSE

Bib Name	NOC
----------	-----

### RINGS

Bib Name	NOC
----------	-----

### VAULT

Bib Name	NOC
----------	-----

### PARALLEL BARS

Bib Name	NOC
006 BELLAOUI Bilal	ALG
005 DJABER Hmida	ALG
002 METIDJI Hillal	ALG
003 BOURGUIEG Mohamed Abdeldjalil	ALG
009 VLAHEK Jakov	CRO
001 PETROV Matvei	ALB

### HORIZONTAL BAR

Bib Name	NOC
020 KHATER Zaid	EGY
021 MOHAMED Omar	EGY
019 ELMARAGHY Ahmed	EGY
017 ABDELRAHMAN Ahmed	EGY
045 CROVETTO Kevin	MON
050 VEFIC Petar	SRB
051 DEJANOVIC Ivan	SRB



## START LIST

Men's Qualifications and Team Final  
SUBDIVISION 1 of 2 - ROTATION 6 of 6  
27 June 2022 - 17:30 to 18:00

### FLOOR

Bib Name	NOC
020 KHATER Zaid	EGY
021 MOHAMED Omar	EGY
017 ABDELRAHMAN Ahmed	EGY
050 VEFIC Petar	SRB
051 DEJANOVIC Ivan	SRB
052 BOZIC Nikolaj	SLO
045 CROVETTO Kevin	MON

### POMMELS HORSE

Bib Name	NOC
048 ALMEIDA Filipe	POR
046 CAMPOS Guilherme	POR
049 NOGUEIRA Jose	POR
047 MARQUES Marcelo	POR
056 NAJJAR Lais	SYR
054 AL SOULIMAN Yazan	SYR
044 CITAKU Elvis	KOS

### RINGS

Bib Name	NOC
----------	-----

### VAULT

Bib Name	NOC
----------	-----

### PARALLEL BARS

Bib Name	NOC
----------	-----

### HORIZONTAL BAR

Bib Name	NOC
006 BELLAOUI Bilal	ALG
005 DJABER Hmida	ALG
002 METIDJI Hillal	ALG
003 BOURGUIEG Mohamed Abdeldjalil	ALG
008 SRBIC Tin	CRO
001 PETROV Matvei	ALB
009 VLAHEK Jakov	CRO



## START LIST

Men's Qualifications and Team Final  
SUBDIVISION 2 of 2 - ROTATION 1 of 6  
27 June 2022 - 19:00 to 19:30

### FLOOR

Bib Name	NOC
011 ANGONAS Georgios	CYP
013 GEORGIU Marios	CYP
012 CHARI Michalis	CYP
016 PILAKOURIS Sokratis	CYP
027 WILLIAMS Joshua Jack	ESP
023 DIALLO Thierno	ESP
025 PLATA Joel	ESP
024 MIR Nicolau	ESP

### POMMELS HORSE

Bib Name	NOC
028 BERNARD Cameron-Lie	FRA
031 PHILIPPE Mathias	FRA
032 SALADINO Leo	FRA
033 SALEUR Julien	FRA
060 DEMIR Sercan	TUR
058 ASIL Adem	TUR
061 ONDER Ahmet	TUR
057 ARICAN Ferhat	TUR

### RINGS

Bib Name	NOC
037 TANTALIDIS Antonios	GRE
034 ILIOPOULOS Nikolaos	GRE
036 KONSTANTINIDIS Christoforos	GRE
038 TSOLAKIDIS Stefanos	GRE
041 LEVANTESI Matteo	ITA
039 BARTOLINI Nicola	ITA
040 CASALI Lorenzo Minh	ITA
042 LODADIO Marco	ITA

### VAULT

Bib Name	NOC
----------	-----

### PARALLEL BARS

Bib Name	NOC
----------	-----

### HORIZONTAL BAR

Bib Name	NOC
----------	-----



## START LIST

Men's Qualifications and Team Final  
SUBDIVISION 2 of 2 - ROTATION 2 of 6  
27 June 2022 - 19:30 to 20:00

### FLOOR

Bib Name	NOC
----------	-----

### POMMELS HORSE

Bib Name	NOC
----------	-----

011 ANGONAS Georgios	CYP
012 CHARI Michalis	CYP
013 GEORGIOU Marios	CYP
014 GEORGIOU Ilias	CYP
027 WILLIAMS Joshua Jack	ESP
024 MIR Nicolau	ESP
023 DIALLO Thierno	ESP
025 PLATA Joel	ESP

### RINGS

Bib Name	NOC
----------	-----

029 BOULET Edgar	FRA
028 BERNARD Cameron-Lie	FRA
032 SALADINO Leo	FRA
031 PHILIPPE Mathias	FRA
060 DEMIR Sercan	TUR
058 ASIL Adem	TUR
061 ONDER Ahmet	TUR
059 COLAK Ibrahim	TUR

### VAULT

Bib Name	NOC
----------	-----

036 KONSTANTINIDIS Christoforos	GRE
034 ILIOPOULOS Nikolaos	GRE
038 TSOLAKIDIS Stefanos	GRE
037 TANTALIDIS Antonios	GRE
041 LEVANTESI Matteo	ITA *
040 CASALI Lorenzo Minh	ITA
039 BARTOLINI Nicola	ITA *
042 LODADIO Marco	ITA

### PARALLEL BARS

Bib Name	NOC
----------	-----

### HORIZONTAL BAR

Bib Name	NOC
----------	-----





## START LIST

Men's Qualifications and Team Final  
SUBDIVISION 2 of 2 - ROTATION 3 of 6  
27 June 2022 - 20:00 to 20:30

### FLOOR

Bib Name	NOC
----------	-----

### POMMELS HORSE

Bib Name	NOC
----------	-----

### RINGS

Bib Name	NOC
012 CHARI Michalis	CYP
011 ANGONAS Georgios	CYP
013 GEORGIU Marios	CYP
016 PILAKOURIS Sokratis	CYP
023 DIALLO Thierno	ESP
024 MIR Nicolau	ESP
025 PLATA Joel	ESP
022 ABAD Nestor	ESP

### VAULT

Bib Name	NOC
031 PHILIPPE Mathias	FRA
029 BOULET Edgar	FRA
033 SALEUR Julien	FRA
032 SALADINO Leo	FRA *
060 DEMIR Sercan	TUR
058 ASIL Adem	TUR *
061 ONDER Ahmet	TUR *
057 ARICAN Ferhat	TUR

### PARALLEL BARS

Bib Name	NOC
037 TANTALIDIS Antonios	GRE
034 ILIOPOULOS Nikolaos	GRE
035 KANELLOS Apostolos	GRE
038 TSOLAKIDIS Stefanos	GRE
040 CASALI Lorenzo Minh	ITA
039 BARTOLINI Nicola	ITA
041 LEVANTESI Matteo	ITA
112 GIANNINI Lay	ITA

### HORIZONTAL BAR

Bib Name	NOC
----------	-----



## START LIST

Men's Qualifications and Team Final  
SUBDIVISION 2 of 2 - ROTATION 4 of 6  
27 June 2022 - 20:30 to 21:00

### FLOOR

### POMMELS HORSE

Bib Name	NOC
----------	-----

Bib Name	NOC
----------	-----

### RINGS

### VAULT

Bib Name	NOC
----------	-----

Bib Name	NOC
----------	-----

012 CHARI Michalis	CYP
013 GEORGIU Marios	CYP
014 GEORGIU Ilias	CYP
011 ANGONAS Georgios	CYP *
023 DIALLO Thierno	ESP
025 PLATA Joel	ESP
022 ABAD Nestor	ESP
024 MIR Nicolau	ESP

### PARALLEL BARS

### HORIZONTAL BAR

Bib Name	NOC
----------	-----

Bib Name	NOC
----------	-----

033 SALEUR Julien	FRA	037 TANTALIDIS Antonios	GRE
032 SALADINO Leo	FRA	034 ILIOPOULOS Nikolaos	GRE
031 PHILIPPE Mathias	FRA	035 KANELLOS Apostolos	GRE
028 BERNARD Cameron-Lie	FRA	038 TSOLAKIDIS Stefanos	GRE
060 DEMIR Sercan	TUR	040 CASALI Lorenzo Minh	ITA
058 ASIL Adem	TUR	039 BARTOLINI Nicola	ITA
061 ONDER Ahmet	TUR	041 LEVANTESI Matteo	ITA
057 ARICAN Ferhat	TUR	112 GIANNINI Lay	ITA



START LIST  
SUBDIVISION 2 of 2 - ROTATION 5 of 6  
27 June 2022 - 21:00 to 21:30

**FLOOR**

Bib Name	NOC
035 KANELLOS Apostolos	GRE
034 ILIOPOULOS Nikolaos	GRE
036 KONSTANTINIDIS Christoforos	GRE
037 TANTALIDIS Antonios	GRE
041 LEVANTESI Matteo	ITA
040 CASALI Lorenzo Minh	ITA
039 BARTOLINI Nicola	ITA
042 LODADIO Marco	ITA

**POMMELS HORSE**

Bib Name	NOC
----------	-----

**RINGS**

Bib Name	NOC
----------	-----

**VAULT**

Bib Name	NOC
----------	-----

**PARALLEL BARS**

Bib Name	NOC
012 CHARI Michalis	CYP
014 GEORGIU Ilias	CYP
013 GEORGIU Marios	CYP
011 ANGONAS Georgios	CYP
025 PLATA Joel	ESP
023 DIALLO Thierno	ESP
022 ABAD Nestor	ESP
024 MIR Nicolau	ESP

**HORIZONTAL BAR**

Bib Name	NOC
033 SALEUR Julien	FRA
032 SALADINO Leo	FRA
031 PHILIPPE Mathias	FRA
029 BOULET Edgar	FRA
060 DEMIR Sercan	TUR
058 ASIL Adem	TUR
061 ONDER Ahmet	TUR
057 ARICAN Ferhat	TUR



START LIST  
SUBDIVISION 2 of 2 - ROTATION 6 of 6  
27 June 2022 - 21:30 to 22:00

FLOOR

Bib Name	NOC
033 SALEUR Julien	FRA
029 BOULET Edgar	FRA
031 PHILIPPE Mathias	FRA
032 SALADINO Leo	FRA
060 DEMIR Sercan	TUR
059 COLAK Ibrahim	TUR
061 ONDER Ahmet	TUR
058 ASIL Adem	TUR

POMMELS HORSE

Bib Name	NOC
035 KANELLOS Apostolos	GRE
034 ILIOPOULOS Nikolaos	GRE
035 KANELLOS Apostolos	GRE
037 TANTALIDIS Antonios	GRE
041 LEVANTESI Matteo	ITA
040 CASALI Lorenzo Minh	ITA
039 BARTOLINI Nicola	ITA
112 GIANNINI Lay	ITA

RINGS

Bib Name	NOC
----------	-----

VAULT

Bib Name	NOC
----------	-----

PARALLEL BARS

Bib Name	NOC
----------	-----

HORIZONTAL BAR

Bib Name	NOC
012 CHARI Michalis	CYP
014 GEORGIU Ilias	CYP
013 GEORGIU Marios	CYP
011 ANGONAS Georgios	CYP
023 DIALLO Thierno	ESP
024 MIR Nicolau	ESP
022 ABAD Nestor	ESP
025 PLATA Joel	ESP



19th MEDITERANIAN GAMES  
26 - 29 JUNE 2022 ORAN, ALGERIA



## JUDGES ASSIGNMENT

### ALL AROUND

#### Competition Jury

Arturs Mickevics FIG



Number	JUDGES		Nation
--------	--------	--	--------

<b>D1</b>	DIAZ LOZA	ROBERTO JAVIER	ESP
<b>D2</b>	MANDICH	FLAVIO	ITA
<b>E1</b>	ABDELHAMID ELNADY	HESHAM	EGY
<b>E2</b>	STYLIANOU	SOTIRIS	CYP
<b>E3</b>	HADJI	ABDELMADJID	ALG
<b>E4</b>	TURKDOGAN	SENL	TUR
<b>T</b>	OUCHÉFOUN	MAHFOUDH	ALG
<b>L1</b>	KAID-SLIMANE	MAHAMMED SALIM	ALG
<b>L2</b>	BENNILA	ABDELKADER	ALG



Number	JUDGES		Nation
--------	--------	--	--------

<b>D1</b>	HODZIC LEDERER	ENES	SLO
<b>D2</b>	OZGOREN	ZIYA	TUR
<b>E1</b>	LE ROCH	TANGUY	FRA
<b>E2</b>	VUKOVIC	RATKO	CRO
<b>E3</b>	MAHMOUD	ARAFAT	EGY
<b>E4</b>	MOUDJEB	MISSOUM	ALG



Number	JUDGES		Nation
--------	--------	--	--------

<b>D1</b>	HADJI	MOHAMMED SAMIL	ALG
<b>D2</b>	ALYOUSEF	NEDAL	SYR
<b>E1</b>	TOR FERREIRA DA CC	MANUEL	POR
<b>E2</b>	MIKES	GEZA	SRB
<b>E3</b>	JOVANOVIC	DEJAN	SLO
<b>E4</b>	BARBOLINI	UBER	ITA



Number	JUDGES		Nation
--------	--------	--	--------

<b>D1</b>	DIAZ LOZA	ROBERTO JAVIER	ESP
<b>D2</b>	MANDICH	FLAVIO	ITA
<b>E1</b>	ABDELHAMID ELNADY	HESHAM	EGY
<b>E2</b>	STYLIANOU	SOTIRIS	CYP
<b>E3</b>	HADJI	ABDELMADJID	ALG
<b>E4</b>	TURKDOGAN	SENL	TUR
<b>L</b>	KAID-SLIMANE	MAHAMMED SALIM	ALG



Number	JUDGES		Nation
--------	--------	--	--------

<b>D1</b>	HODZIC LEDERER	ENES	SLO
<b>D2</b>	OZGOREN	ZIYA	TUR
<b>E1</b>	LE ROCH	TANGUY	FRA
<b>E2</b>	VUKOVIC	RATKO	CRO
<b>E3</b>	MAHMOUD	ARAFAT	EGY
<b>E4</b>	MOUDJEB	MISSOUM	ALG
<b>T</b>	BAXEVANIDIS	DIMITRIOS	GRE



Number	JUDGES		Nation
--------	--------	--	--------

<b>D1</b>	HADJI	MOHAMMED SAMIL	ALG
<b>D2</b>	ALYOUSEF	NEDAL	SYR
<b>E1</b>	ABDELHAMID ELNADY	HESHAM	EGY
<b>E2</b>	STYLIANOU	SOTIRIS	CYP
<b>E3</b>	HADJI	ABDELMADJID	ALG
<b>E4</b>	TURKDOGAN	SENL	TUR







R1

R1



## RESULTS

### MEN'S QUALIFICATIONS AND TEAM FINAL

Rank	Bib	NOC Name							Pen.	Total	Ind. Ran
<b>1</b>		<b>TUR - Turkiye</b>									
	061	ONDER Ahmet	14.250	13.150	13.900	13,950	15,150	13,650		84.050	( 1)
	058	ASIL Adem	14.400	13.300	14.600	13,500	14,050	13,800		83.650	( 2)
	060	DEMIR Sercan	13.450	10.400	13.250	13,150	14,000	13,100		77.350	(15)
	057	ARICAN Ferhat		13.800		14,100	14,450	12,700		55.050	(33)
	059	COLAK Ibrahim	12.400		14.650					27.050	(43)
		<b>Total</b>	(1) 42.100	(1) 40.250	(1) 43.150	(5) 41.550	(1) 43.650	(1) 40.550		<b>251.250</b>	
<b>2</b>		<b>ITA - Italy</b>									
	039	BARTOLINI Nicola	14.600	13.700	12.900	14,650	14,050	13,250		83.150	( 3)
	040	CASALI Lorenzo Minh	13.300	12.950	13.300	14,300	14,150	13,250		81.250	( 7)
	041	LEVANTESI Matteo	11.300	12.650	13.000	14,400	14,750	13,600		79.700	( 9)
	112	GIANNINI Lay		11.700			14,350	13,200		39.250	(40)
	042	LODADIO Marco	3.100		14.600	13,600				31.300	(41)
		<b>Total</b>	(5) 39.200	(5) 39.300	(3) 40.900	(1) 43.350	(2) 43.250	(2) 40.100		<b>246.100</b>	
<b>3</b>		<b>FRA - France</b>									
	031	PHILIPPE Mathias	13.350	12.650	13.700	13,300	14,300	13,500		80.800	( 8)
	032	SALADINO Leo	12.100	13.500	13.600	13,100	10,900	11,700		74.900	(20)
	033	SALEUR Julien	12.800	13.600		13,550	13,650	13,150		66.750	(31)
	029	BOULET Edgar	13.600		12.400	13,800		13,250		53.050	(37)
	028	BERNARD Cameron-Lie		12.250	12.950		14,650			39.850	(39)
		<b>Total</b>	(3) 39.750	(2) 39.750	(4) 40.250	(7) 40.650	(3) 42.600	(4) 39.900		<b>242.900</b>	
<b>4</b>		<b>ESP - Spain</b>									
	024	MIR Nicolau	13.900	12.500	13.100	14,300	14,250	13,350		81.400	( 6)
	025	PLATA Joel	13.800	13.450	13.350	13,800	12,250	11,850		78.500	(12)
	023	DIALLO Thierno	12.500	13.750	12.950	13,650	13,900	11,650		78.400	(13)
	022	ABAD Nestor			13.350	13,850	13,300	13,250		53.750	(36)
	027	WILLIAMS Joshua Jack	12.850	11.900						24.750	(44)
		<b>Total</b>	(2) 40.550	(3) 39.700	(5) 39.800	(2) 41.950	(4) 41.450	(6) 38.450		<b>241.900</b>	
<b>5</b>		<b>EGY - Egypt</b>									
	021	MOHAMED Omar	14.000	13.600	14.300	13,850	13,700	13,300		82.750	( 4)
	017	ABDELRAHMAN Ahmed	12.200	13.100	11.700	14,050	12,750	13,100		76.900	(17)
	020	KHATER Zaid	11.050	12.950	13.200	10,200	13,300	12,400		73.100	(24)
	018	ZAHARAN Ali			14.300					14.300	(50)
	019	ELMARAGHY Ahmed						13,650		13.650	(52)
		<b>Total</b>	(7) 37.250	(4) 39.650	(2) 41.800	(9) 38.100	(6) 39.750	(3) 40.050		<b>236.600</b>	







Report created MON 27 JUN 2022 22:00:37

Data Processing and Timing by Microplus — www.microplustiming.com



## RESULTS































### MEN'S QUALIFICATIONS AND TEAM FINAL

Rank	Bib	NOC Name							Pen.	Total	Ind. Ran
<b>6</b>		<b>CYP - Cyprus</b>									
	013	GEORGIU Marios	13.450	14.200	13.300	13,600	14,100	13,800		82.450	( 5)
	011	ANGONAS Georgios	10.750	11.150	12.150	13,900	12,950	12,900		73.800	(23)
	012	CHARI Michalis	12.650	11.400	11.750	12,650	11,600	11,500		71.550	(27)
	014	GEORGIU Ilias		12.400		14,400	14,200	13,050		54.050	(34)
	016	PILAKOURIS Sokratis	11.350		12.250					23.600	(46)
		<b>Total</b>	(6) 37.450	(8) 38.000	(7) 37.700	(3) 41.900	(5) 41.250	(5) 39.750		<b>236.050</b>	
<b>7</b>		<b>GRE - Greece</b>									
	037	TANTALIDIS Antonios	13.700	14.300	12.550	14,200	13,050	11,850		79.650	(10)
	034	ILIOPOULOS Nikolaos	12.550	12.450	13.500	13,850	13,800	13,350		79.500	(11)
	035	KANELLOS Apostolos	10.600	11.600			12,800	12,550		47.550	(38)
	036	KONSTANTINIDIS Christ	5.350		9.750	13,800				28.900	(42)
	038	TSOLAKIDIS Stefanos			11.400	12,450				23.850	(45)
		<b>Total</b>	(8) 36.850	(6) 38.350	(9) 37.450	(4) 41.850	(7) 39.650	(7) 37.750		<b>231.900</b>	
<b>8</b>		<b>POR - Portugal</b>									
	048	ALMEIDA Filipe	12.950	12.550	12.950	14,000	12,250	12,450		77.150	(16)
	049	NOGUEIRA Jose	13.200	12.600	12.900	12,250	12,800	12,650		76.400	(18)
	047	MARQUES Marcelo	13.100	12.950	11.650	12,850	11,700	11,950		74.200	(21)
	046	CAMPOS Guilherme	13.350	11.400	12.600	13,600	11,550	11,600		74.100	(22)
		<b>Total</b>	(4) 39.650	(7) 38.100	(6) 38.450	(8) 40.450	(9) 36.750	(8) 37.050		<b>230.450</b>	
<b>9</b>		<b>ALG - Algeria</b>									
	002	METIDJI Hillal	12.050	12.950	12.500	13,850	13,400	12,750		77.500	(14)
	003	BOURGUIEG Mohamed /	11.200	10.200	12.550	13,700	12,700	12,050		72.400	(25)
	005	DJABER Hmida	11.400	11.600	12.200	12,950	12,350	9,550		70.050	(29)
	006	BELLAOUI Bilal	12.850		12.500	13,150	11,900	11,650		62.050	(32)
	004	YOUSFI Mohamed Amine		12.400						12.400	(55)
		<b>Total</b>	(9) 36.300	(9) 36.950	(8) 37.550	(6) 40.700	(8) 38.450	(9) 36.450		<b>226.400</b>	



## RESULTS

### MEN'S QUALIFICATIONS ALL AROUND

Rank	Bib	Name	NOC Code	D	E1	E2	E3	E4	E5	E6	E Score	Pen.	Total	Rank by App.		
<b>1</b>	061	ONDER Ahmet	TUR		5.800						8,450		<b>14.250</b>	(3)		
					5.300							7,850		<b>13.150</b>	(15)	
					5.500								8,400		<b>13.900</b>	(6)
					5.200								8,850	-0.10	<b>13.950</b>	(10)
					6.400								8,750		<b>15.150</b>	(1)
					5.900								7,750		<b>13.650</b>	(4)
		<b>TOTAL :</b>											<b>84.050</b>			
		<b>Q</b>														
<b>2</b>	058	ASIL Adem	TUR		5.800						8,600		<b>14.400</b>	(2)		
					5.100							8,200		<b>13.300</b>	(14)	
					6.300								8,300		<b>14.600</b>	(2)
					5.600								8,000	-0.10	<b>13.500</b>	(26)
					5.600								8,450		<b>14.050</b>	(12)
					5.400								8,400		<b>13.800</b>	(2)
		<b>TOTAL :</b>											<b>83.650</b>			
		<b>Q</b>														
<b>3</b>	039	BARTOLINI Nicola	ITA		5.900						8,700		<b>14.600</b>	(1)		
					5.500							8,200		<b>13.700</b>	(8)	
					4.300								8,600		<b>12.900</b>	(22)
					5.200								9,450		<b>14.650</b>	(1)
					5.600								8,450		<b>14.050</b>	(11)
					4.500								8,750		<b>13.250</b>	(13)
		<b>TOTAL :</b>											<b>83.150</b>			
		<b>Q</b>														
<b>4</b>	021	MOHAMED Omar	EGY		5.500						8,500		<b>14.000</b>	(4)		
					5.300							8,300		<b>13.600</b>	(11)	
					5.600								8,700		<b>14.300</b>	(5)
					5.200								8,950	-0.30	<b>13.850</b>	(13)
					5.600								8,100		<b>13.700</b>	(16)
					4.800								8,500		<b>13.300</b>	(10)
		<b>TOTAL :</b>											<b>82.750</b>			
		<b>Q</b>														
<b>5</b>	013	GEORGIU Marios	CYP		5.600						7,850		<b>13.450</b>	(10)		
					5.700							8,500		<b>14.200</b>	(3)	
					4.900								8,400		<b>13.300</b>	(12)
					4.800								8,800		<b>13.600</b>	(22)
					5.800								8,300		<b>14.100</b>	(10)
					5.800								8,000		<b>13.800</b>	(1)
		<b>TOTAL :</b>											<b>82.450</b>			
		<b>Q</b>														

Report created MON 27 JUN 2022 22:38:29

























Data Processing and Timing by Microplus — www.microplustiming.com





## RESULTS































### MEN'S QUALIFICATIONS ALL AROUND

Rank	Bib	Name	NOC Code	D	E1	E2	E3	E4	E5	E6	E Score	Pen.	Total	Rank by App.		
6	024	MIR Nicolau	ESP								5.300		8,600	13.900 (5)		
													5.100		7,400	12.500 (25)
													4.900		8,200	13.100 (16)
													5.200		9,100	14.300 (4)
													5.500		8,750	14.250 (7)
													4.900		8,450	13.350 (7)
		<b>TOTAL :</b>											<b>81.400</b>			
													<b>Q</b>			
7	040	CASALI Lorenzo Minh	ITA								5.400		7,900	13.300 (13)		
													4.600		8,350	12.950 (17)
													4.800		8,500	13.300 (13)
													5.200		9,100	14.300 (5)
													5.600		8,550	14.150 (9)
													5.000		8,250	13.250 (14)
		<b>TOTAL :</b>											<b>81.250</b>			
													<b>Q</b>			
8	031	PHILIPPE Mathias	FRA								5.400		7,950	13.350 (11)		
													4.400		8,250	12.650 (22)
													5.500		8,200	13.700 (7)
													4.000		9,300	13.300 (27)
													6.100		8,200	14.300 (6)
													5.600		7,900	13.500 (6)
		<b>TOTAL :</b>											<b>80.800</b>			
													<b>Q</b>			
9	041	LEVANTESI Matteo	ITA								5.500		6,100	-0.30 11.300 (33)		
													4.700		7,950	12.650 (21)
													4.700		8,300	13.000 (17)
													5.200		9,200	14.400 (2)
													5.600		9,150	14.750 (2)
													5.100		8,500	13.600 (5)
		<b>TOTAL :</b>											<b>79.700</b>			



## RESULTS

### MEN'S QUALIFICATIONS ALL AROUND

Rank	Bib	Name	NOC Code	D	E1	E2	E3	E4	E5	E6	E Score	Pen.	Total	Rank by App.				
<b>10</b>	037	TANTALIDIS Antonios	GRE								8,100		<b>13.700</b>	(7)				
													5,700		8,600	<b>14.300</b>	(2)	
														3,900		8,650	<b>12.550</b>	(24)
														5,200		9,000	<b>14.200</b>	(6)
														4,000		9,050	<b>13.050</b>	(21)
														4,100		7,750	<b>11.850</b>	(32)
<b>TOTAL :</b>		<b>79.650</b>																
		<b>Q</b>																
<b>11</b>	034	ILIOPOULOS Nikolaos	GRE								7,850		<b>12.550</b>	(23)				
													4,400		8,050	<b>12.450</b>	(26)	
														4,800		8,700	<b>13.500</b>	(9)
														4,800		9,050	<b>13.850</b>	(15)
														5,500		8,300	<b>13.800</b>	(15)
														5,200		8,150	<b>13.350</b>	(9)
<b>TOTAL :</b>		<b>79.500</b>																
		<b>Q</b>																
<b>12</b>	025	PLATA Joel	ESP								8,200		<b>13.800</b>	(6)				
													5,400		8,050	<b>13.450</b>	(13)	
														5,000		8,350	<b>13.350</b>	(11)
														4,800		9,000	<b>13.800</b>	(18)
														5,500		6,750	<b>12.250</b>	(30)
														5,200		6,650	<b>11.850</b>	(31)
<b>TOTAL :</b>		<b>78.500</b>																
		<b>Q</b>																
<b>13</b>	023	DIALLO Thierno	ESP								7,600	-0.40	<b>12.500</b>	(24)				
													5,800		7,950	<b>13.750</b>	(7)	
														4,700		8,250	<b>12.950</b>	(20)
														4,800		8,850	<b>13.650</b>	(21)
														5,900		8,000	<b>13.900</b>	(14)
														4,700		6,950	<b>11.650</b>	(34)
<b>TOTAL :</b>		<b>78.400</b>																
		<b>Q</b>																
<b>14</b>	002	METIDJI Hillal	ALG								7,950		<b>12.050</b>	(29)				
													4,900		8,050	<b>12.950</b>	(20)	
														4,500		8,000	<b>12.500</b>	(27)
														5,200		8,950	<b>13.850</b>	(12)
														5,200		8,200	<b>13.400</b>	(18)
														4,400		8,350	<b>12.750</b>	(21)
<b>TOTAL :</b>		<b>77.500</b>																
		<b>Q</b>																































Report created MON 27 JUN 2022 22:38:29

Data Processing and Timing by Microplus — www.microplustiming.com



## RESULTS

### MEN'S QUALIFICATIONS ALL AROUND

Rank	Bib	Name	NOC Code	D	E1	E2	E3	E4	E5	E6	E Score	Pen.	Total	Rank by App.		
<b>15</b>	060	DEMIR Sercan	TUR		5.300						8,150		<b>13.450</b>	(9)		
					4.200							6,200		<b>10.400</b>	(40)	
					5.200								8,050		<b>13.250</b>	(14)
					4.000								9,150		<b>13.150</b>	(30)
					5.900								8,100		<b>14.000</b>	(13)
					4.800								8,300		<b>13.100</b>	(18)
<b>TOTAL : 77.350</b>																
<b>16</b>	048	ALMEIDA Filipe	POR		4.800						8,250	-0.10	<b>12.950</b>	(17)		
					4.100							8,450		<b>12.550</b>	(24)	
					4.100								8,850		<b>12.950</b>	(18)
					5.200								8,800		<b>14.000</b>	(9)
					3.600								8,650		<b>12.250</b>	(31)
					3.600								8,850		<b>12.450</b>	(26)
<b>TOTAL : 77.150</b>																
<b>Q</b>																
<b>17</b>	017	ABDELRAHMAN Ahmed	EGY		5.000						7,300	-0.10	<b>12.200</b>	(27)		
					4.600							8,500		<b>13.100</b>	(16)	
					4.600								7,100		<b>11.700</b>	(35)
					5.200								8,850		<b>14.050</b>	(8)
					4.700								8,050		<b>12.750</b>	(26)
					4.600								8,500		<b>13.100</b>	(17)
<b>TOTAL : 76.900</b>																
<b>Q</b>																
<b>18</b>	049	NOGUEIRA Jose	POR		5.300						7,900		<b>13.200</b>	(15)		
					4.100							8,500		<b>12.600</b>	(23)	
					4.200								8,700		<b>12.900</b>	(21)
					3.200								9,050		<b>12.250</b>	(38)
					4.100								8,700		<b>12.800</b>	(24)
					4.200								8,450		<b>12.650</b>	(23)
<b>TOTAL : 76.400</b>																
<b>Q</b>																
<b>19</b>	056	NAJJAR Lais	SYR		4.900						8,050		<b>12.950</b>	(18)		
					5.300							8,350		<b>13.650</b>	(9)	
					3.900								8,600		<b>12.500</b>	(28)
					4.800								9,150	-0.10	<b>13.850</b>	(16)
					4.600								5,500		<b>10.100</b>	(39)
					4.200								8,400		<b>12.600</b>	(24)
<b>TOTAL : 75.650</b>																
<b>Q</b>																

























Report created MON 27 JUN 2022 22:38:29

Data Processing and Timing by Microplus — www.microplustiming.com



## RESULTS































### MEN'S QUALIFICATIONS ALL AROUND

Rank	Bib	Name	NOC Code	D	E1	E2	E3	E4	E5	E6	E Score	Pen.	Total	Rank by App.				
<b>20</b>	032	SALADINO Leo	FRA								5.500		7,000	-0.40	<b>12.100</b> (28)			
													5.200		8,300		<b>13.500</b> (12)	
														5.100		8,500		<b>13.600</b> (8)
														5.600		7,800	-0.30	<b>13.100</b> (31)
														5.400		5,500		<b>10.900</b> (38)
														4.500		7,200		<b>11.700</b> (33)
<b>TOTAL :</b>		<b>74.900</b>													<b>Q</b>			
<b>21</b>	047	MARQUES Marcelo	POR								5.200		7,900		<b>13.100</b> (16)			
													5.200		7,750		<b>12.950</b> (18)	
														3.700		7,950		<b>11.650</b> (36)
														4.000		8,850		<b>12.850</b> (34)
														3.700		8,000		<b>11.700</b> (34)
														3.400		8,550		<b>11.950</b> (30)
<b>TOTAL :</b>		<b>74.200</b>																
<b>22</b>	046	CAMPOS Guilherme	POR								5.400		7,950		<b>13.350</b> (12)			
													3.500		7,900		<b>11.400</b> (35)	
														4.200		8,400		<b>12.600</b> (23)
														4.800		8,900	-0.10	<b>13.600</b> (24)
														3.800		7,750		<b>11.550</b> (36)
														3.700		7,900		<b>11.600</b> (36)
<b>TOTAL :</b>		<b>74.100</b>																
<b>23</b>	011	ANGONAS Georgios	CYP								4.800		6,250	-0.30	<b>10.750</b> (36)			
													4.300		6,850		<b>11.150</b> (38)	
														4.000		8,150		<b>12.150</b> (33)
														4.800		9,100		<b>13.900</b> (11)
														5.100		7,850		<b>12.950</b> (22)
														4.600		8,300		<b>12.900</b> (20)
<b>TOTAL :</b>		<b>73.800</b>													<b>Q</b>			



## RESULTS

### MEN'S QUALIFICATIONS ALL AROUND

Rank	Bib	Name	NOC Code	D	E1	E2	E3	E4	E5	E6	E Score	Pen.	Total	Rank by App.				
<b>24</b>	020	KHATER Zaid	EGY								4.700		7,050	-0.70	<b>11.050</b> (35)			
													5.100		7,850		<b>12.950</b> (19)	
														4.800		8,400		<b>13.200</b> (15)
														2.400		7,800		<b>10.200</b> (43)
														5.200		8,100		<b>13.300</b> (20)
														4.500		7,900		<b>12.400</b> (27)
<b>TOTAL :</b>		<b>73.100</b>																
<b>25</b>	003	BOURGUIEG Mohamed Abdeldjalil	ALG								4.400		7,400	-0.60	<b>11.200</b> (34)			
													3.600		6,600		<b>10.200</b> (41)	
														3.900		8,650		<b>12.550</b> (25)
														4.800		8,900		<b>13.700</b> (20)
														4.200		8,500		<b>12.700</b> (27)
														4.100		7,950		<b>12.050</b> (29)
<b>TOTAL :</b>		<b>72.400</b>													<b>Q</b>			
<b>26</b>	045	CROVETTO Kevin	MON								4.400		8,150	-0.10	<b>12.450</b> (25)			
													3.200		8,050		<b>11.250</b> (37)	
														3.800		7,600		<b>11.400</b> (38)
														4.400		8,750		<b>13.150</b> (29)
														3.800		8,450		<b>12.250</b> (29)
														3.800		7,350		<b>11.150</b> (39)
<b>TOTAL :</b>		<b>71.650</b>													<b>Q</b>			
<b>27</b>	012	CHARI Michalis	CYP								5.400		7,250		<b>12.650</b> (22)			
													4.000		7,400		<b>11.400</b> (36)	
														4.100		7,650		<b>11.750</b> (34)
														4.800		7,850		<b>12.650</b> (36)
														3.900		7,700		<b>11.600</b> (35)
														3.800		7,700		<b>11.500</b> (37)
<b>TOTAL :</b>		<b>71.550</b>																
<b>28</b>	050	VEFIC Petar	SRB								4.500		5,350		<b>9.850</b> (38)			
													3.800		7,800		<b>11.600</b> (33)	
														4.200		8,200		<b>12.400</b> (30)
														4.000		8,800	-0.10	<b>12.700</b> (35)
														5.500		7,350		<b>12.850</b> (23)
														4.500		7,000		<b>11.500</b> (38)
<b>TOTAL :</b>		<b>70.900</b>													<b>Q</b>			













Report created MON 27 JUN 2022 22:38:29

Data Processing and Timing by Microplus — www.microplustiming.com



## RESULTS







### MEN'S QUALIFICATIONS ALL AROUND

Rank	Bib	Name	NOC Code	D	E1	E2	E3	E4	E5	E6	E Score	Pen.	Total	Rank by App.				
<b>29</b>	005	DJABER Hmida	ALG								4.700		6,800	-0.10	<b>11.400</b> (31)			
													3.900		7,700		<b>11.600</b> (34)	
														4.200		8,000		<b>12.200</b> (32)
														4.000		8,950		<b>12.950</b> (33)
														4.400		7,950		<b>12.350</b> (28)
														4.000		5,550		<b>9.550</b> (41)
		<b>TOTAL :</b>											<b>70.050</b>					
<b>30</b>	054	AL SOULIMAN Yazan	SYR								4.800		7,150	-0.10	<b>11.850</b> (30)			
													4.300		6,350		<b>10.650</b> (39)	
														3.000		8,000		<b>11.000</b> (39)
														4.400		7,850	-0.30	<b>11.950</b> (39)
														4.000		7,900		<b>11.900</b> (32)
														3.200		6,800		<b>10.000</b> (40)
		<b>TOTAL :</b>											<b>67.350</b>		<b>Q</b>			



## RESULTS

### MEN'S QUALIFICATIONS ALL AROUND

Rank	Bib	Name	NOC Code	D	E1	E2	E3	E4	E5	E6	E Score	Pen.	Total	Rank by App.
31	009	VLAHEK Jakov	CRO		2.700						8,750	-3.30	8.150	(39)
					5.700						8,300		14.000	(4)
					1.600						9,000	-5.30	5.300	(41)
					1.600						9,200		10.800	(42)
					2.600						8,600		11.200	(37)
					1.400						9,000	-6.00	4.400	(42)
		<b>TOTAL :</b>											<b>53.850</b>	
		<b>Q</b>												



## RESULTS MEN'S FLOOR EXERCISE QUALIFICATION



Rank	Bib	Nom Prénom Name Firstname	Fed	D	E1	E2	E3	E4	E5	E6	E	Pen.	Total
1.	039	BARTOLINI Nicola	ITA	5.90							8.70		14.600
2.	058	ASIL Adem	TUR	5.80							8.60		14.400
3.	061	ONDER Ahmet	TUR	5.80							8.45		14.250
4.	021	MOHAMED Omar	EGY	5.50							8.50		14.000
5.	024	MIR Nicolau	ESP	5.30							8.60		13.900
6.	025	PLATA Joel	ESP	5.60							8.20		13.800
7.	037	TANTALIDIS Antonios	GRE	5.60							8.10		13.700
8.	029	BOULET Edgar	FRA	5.90							7.80	-0.10	13.600
9.	060	DEMIR Sercan	TUR	5.30							8.15		13.450
10.	013	GEORGIOU Marios	CYP	5.60							7.85		13.450
11.	031	PHILIPPE Mathias	FRA	5.40							7.95		13.350
11.	046	CAMPOS Guilherme	POR	5.40							7.95		13.350
13.	040	CASALI Lorenzo Minh	ITA	5.40							7.90		13.300
14.	052	BOZIC Nikolaj	SLO	5.30							7.95		13.250
15.	049	NOGUEIRA Jose	POR	5.30							7.90		13.200
16.	047	MARQUES Marcelo	POR	5.20							7.90		13.100
17.	048	ALMEIDA Filipe	POR	4.80							8.25	-0.10	12.950
18.	056	NAJJAR Lais	SYR	4.90							8.05		12.950
19.	006	BELLAOUI Bilal	ALG	4.50							8.35		12.850
20.	027	WILLIAMS Joshua Jack	ESP	4.70							8.15		12.850
21.	033	SALEUR Julien	FRA	5.00							7.80		12.800
22.	012	CHARI Michalis	CYP	5.40							7.25		12.650
23.	034	ILIOPOULOS Nikolaos	GRE	4.70							7.85		12.550

Report created THU 28 JUN 2022 13:50:16

Data Processing and Timing by Microplus — [www.microplustiming.com](http://www.microplustiming.com)





## RESULTS MEN'S FLOOR EXERCISE QUALIFICATION



Rank	Bib	Nom Prénom Name Firstname	Fed	D	E1	E2	E3	E4	E5	E6	E	Pen.	Total
24.	023	DIALLO Thierno	ESP	5.30							7.60	-0.40	12.500
25.	045	CROVETTO Kevin	MON	4.40							8.15	-0.10	12.450
26.	059	COLAK Ibrahim	TUR	5.00							7.40		12.400
27.	017	ABDELRAHMAN Ahmed	EGY	5.00							7.30	-0.10	12.200
28.	032	SALADINO Leo	FRA	5.50							7.00	-0.40	12.100
29.	002	METIDJI Hillal	ALG	4.10							7.95		12.050
30.	054	AL SOULIMAN Yazan	SYR	4.80							7.15	-0.10	11.850
31.	005	DJABER Hmida	ALG	4.70							6.80	-0.10	11.400
32.	016	PILAKOURIS Sokratis	CYP	4.40							6.95		11.350
33.	041	LEVANTESI Matteo	ITA	5.50							6.10	-0.30	11.300
34.	003	BOURGUIEG Mohamed Abdeldj	ALG	4.40							7.40	-0.60	11.200
35.	020	KHATER Zaid	EGY	4.70							7.05	-0.70	11.050
36.	011	ANGONAS Georgios	CYP	4.80							6.25	-0.30	10.750
37.	035	KANELLOS Apostolos	GRE	4.60							6.40	-0.40	10.600
38.	050	VEFIC Petar	SRB	4.50							5.35		9.850
39.	009	VLAHEK Jakov	CRO	2.70							8.75	-3.30	8.150
40.	044	CITAKU Elvis	KOS	3.70							4.00	-0.90	6.800
41.	036	KONSTANTINIDIS Christoforos	GRE	2.50							7.85	-5.00	5.350
42.	042	LODADIO Marco	ITA	1.70							8.40	-7.00	3.100



## RESULTS MEN'S POMMEL HORSE QUALIFICATION

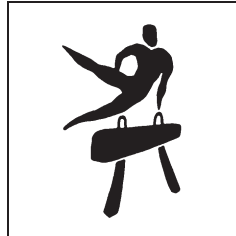

Rank	Nom Prénom Name Firstname	Fed	D	E1	E2	E3	E4	E5	E6	E Score	Pen.	Total
1.	ZUGEC Mateo	CRO	5,70							8.65	14,350	<b>14.350</b>
2.	TANTALIDIS Antonios	GRE	5,70							8.60	14,300	<b>14.300</b>
3.	GEORGIU Marios	CYP	5,70							8.50	14,200	<b>14.200</b>
4.	VLAHEK Jakov	CRO	5,70							8.30	14,000	<b>14.000</b>
5.	PETROV Matvei	ALB	5,70							8.25	13,950	<b>13.950</b>
6.	ARICAN Ferhat	TUR	5,80							8.00	13,800	<b>13.800</b>
7.	DIALLO Thierno	ESP	5,80							7.95	13,750	<b>13.750</b>
8.	BARTOLINI Nicola	ITA	5,50							8.20	13,700	<b>13.700</b>
9.	NAJJAR Lais	SYR	5,30							8.35	13,650	<b>13.650</b>
10.	SALEUR Julien	FRA	5,10							8.50	13,600	<b>13.600</b>
11.	MOHAMED Omar	EGY	5,30							8.30	13,600	<b>13.600</b>
12.	SALADINO Leo	FRA	5,20							8.30	13,500	<b>13.500</b>
13.	PLATA Joel	ESP	5,40							8.05	13,450	<b>13.450</b>
14.	ASIL Adem	TUR	5,10							8.20	13,300	<b>13.300</b>
15.	ONDER Ahmet	TUR	5,30							7.85	13,150	<b>13.150</b>
16.	ABDELRAHMAN Ahmed	EGY	4,60							8.50	13,100	<b>13.100</b>
17.	CASALI Lorenzo Minh	ITA	4,60							8.35	12,950	<b>12.950</b>



## RESULTS MEN'S POMMEL HORSE QUALIFICATION



Rank	Nom Prénom Name Firstname	Fed	D	E1	E2	E3	E4	E5	E6	E Score	Pen.	Total
18.	METIDJI Hillal	ALG	4,90							8.05	12,950	<b>12.950</b>
19.	KHATER Zaid	EGY	5,10							7.85	12,950	<b>12.950</b>
20.	MARQUES Marcelo	POR	5,20							7.75	12,950	<b>12.950</b>
21.	PHILIPPE Mathias	FRA	4,40							8.25	12,650	<b>12.650</b>
22.	LEVANTESI Matteo	ITA	4,70							7.95	12,650	<b>12.650</b>
23.	NOGUEIRA Jose	POR	4,10							8.50	12,600	<b>12.600</b>
24.	ALMEIDA Filipe	POR	4,10							8.45	12,550	<b>12.550</b>
25.	MIR Nicolau	ESP	5,10							7.40	12,500	<b>12.500</b>
26.	ILIOPOULOS Nikolaos	GRE	4,40							8.05	12,450	<b>12.450</b>
27.	GEORGIU Ilias	CYP	4,40							8.00	12,400	<b>12.400</b>
28.	YOUSFI Mohamed Amine	ALG	5,40							7.00	12,400	<b>12.400</b>
29.	BERNARD Cameron-Lie	FRA	5,20							7.05	12,250	<b>12.250</b>
30.	WILLIAMS Joshua Jack	ESP	4,40							7.50	11,900	<b>11.900</b>
31.	GIANNINI Lay	ITA	4,40							7.30	11,700	<b>11.700</b>
32.	VEFIC Petar	SRB	3,80							7.80	11,600	<b>11.600</b>
33.	DJABER Hmida	ALG	3,90							7.70	11,600	<b>11.600</b>
34.	KANELLOS Apostolos	GRE	5,70							5.90	11,600	<b>11.600</b>



## RESULTS MEN'S POMMEL HORSE QUALIFICATION

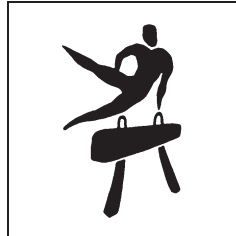

Rank	Nom Prénom Name Firstname	Fed	D	E1	E2	E3	E4	E5	E6	E Score	Pen.	Total
35.	CAMPOS Guilherme	POR	3,50							7.90	11,400	<b>11.400</b>
36.	CHARI Michalis	CYP	4,00							7.40	11,400	<b>11.400</b>
37.	CROVETTO Kevin	MON	3,20							8.05	11,250	<b>11.250</b>
38.	ANGONAS Georgios	CYP	4,30							6.85	11,150	<b>11.150</b>
39.	AL SOULIMAN Yazan	SYR	4,30							6.35	10,650	<b>10.650</b>
40.	DEMIR Sercan	TUR	4,20							6.20	10,400	<b>10.400</b>
41.	BOURGUIEG Mohamed Abdeldjalil	ALG	3,60							6.60	10,200	<b>10.200</b>



## RESULTS MEN'S RINGS QUALIFICATION

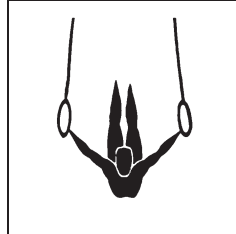

Rank	Bib	Nom Prénom Name Firstname	Fed	D	E1	E2	E3	E4	E5	E6	E	Pen.	Total
1.	059	COLAK Ibrahim	TUR	6,10							8.55		14.650
2.	058	ASIL Adem	TUR	6,30							8.30		14.600
2.	042	LODADIO Marco	ITA	6,30							8.30		14.600
4.	021	MOHAMED Omar	EGY	5,60							8.70		14.300
5.	018	ZHRAN Ali	EGY	6,10							8.20		14.300
6.	061	ONDER Ahmet	TUR	5,50							8.40		13.900
7.	031	PHILIPPE Mathias	FRA	5,50							8.20		13.700
8.	032	SALADINO Leo	FRA	5,10							8.50		13.600
9.	034	ILIOPOULOS Nikolaos	GRE	4,80							8.70		13.500
10.	022	ABAD Nestor	ESP	4,90							8.45		13.350
11.	025	PLATA Joel	ESP	5,00							8.35		13.350
12.	040	CASALI Lorenzo Minh	ITA	4,80							8.50		13.300
13.	013	GEORGIOU Marios	CYP	4,90							8.40		13.300
14.	060	DEMIR Sercan	TUR	5,20							8.05		13.250
15.	020	KHATER Zaid	EGY	4,80							8.40		13.200
16.	024	MIR Nicolau	ESP	4,90							8.20		13.100
17.	041	LEVANTESI Matteo	ITA	4,70							8.30		13.000
18.	048	ALMEIDA Filipe	POR	4,10							8.85		12.950
19.	023	DIALLO Thierno	ESP	4,70							8.25		12.950
20.	028	BERNARD Cameron-Lie	FRA	5,20							7.75		12.950
21.	049	NOGUEIRA Jose	POR	4,20							8.70		12.900
22.	039	BARTOLINI Nicola	ITA	4,30							8.60		12.900
23.	046	CAMPOS Guilherme	POR	4,20							8.40		12.600

Report created THU 28 JUN 2022 13:51:11

Data Processing and Timing by Microplus — [www.microplustiming.com](http://www.microplustiming.com)



## RESULTS MEN'S RINGS QUALIFICATION

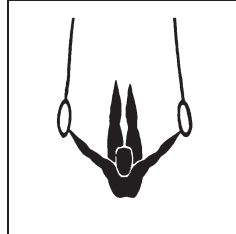

Rank	Bib	Nom Prénom Name Firstname	Fed	D	E1	E2	E3	E4	E5	E6	E	Pen.	Total
24.	003	BOURGUIEG Mohamed Abdeldj	ALG	3.90							8.65		12.550
24.	037	TANTALIDIS Antonios	GRE	3.90							8.65		12.550
26.	056	NAJJAR Lais	SYR	3.90							8.60		12.500
27.	006	BELLAOUI Bilal	ALG	4.00							8.50		12.500
28.	002	METIDJI Hillal	ALG	4.50							8.00		12.500
29.	050	VEFIC Petar	SRB	4.20							8.20		12.400
30.	029	BOULET Edgar	FRA	5.30							7.10		12.400
31.	016	PILAKOURIS Sokratis	CYP	5.80							6.75	-0.30	12.250
32.	005	DJABER Hmida	ALG	4.20							8.00		12.200
33.	011	ANGONAS Georgios	CYP	4.00							8.15		12.150
34.	012	CHARI Michalis	CYP	4.10							7.65		11.750
35.	017	ABDELRAHMAN Ahmed	EGY	4.60							7.10		11.700
36.	047	MARQUES Marcelo	POR	3.70							7.95		11.650
37.	045	CROVETTO Kevin	MON	3.80							7.60		11.400
38.	038	TSOLAKIDIS Stefanos	GRE	4.40							7.00		11.400
39.	054	AL SOULIMAN Yazan	SYR	3.00							8.00		11.000
40.	036	KONSTANTINIDIS Christoforos	GRE	4.60							8.15	-3.00	9.750
41.	009	VLAHEK Jakov	CRO	1.60							9.00	-5.30	5.300



## RESULTS MEN'S VAULT 1

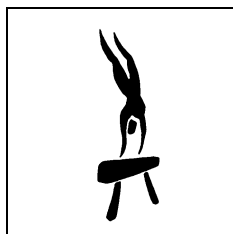

Rank	Bib	Nom Prénom Name Firstname	Fed	D	E1	E2	E3	E4	E5	E6	E	Pen.	Total	
1.	039	BARTOLINI Nicola	ITA	5,20							9.45		14,650	<b>14.650</b>
2.	014	GEORGIOU Ilias	CYP	5,20							9.20		14,400	<b>14.400</b>
2.	041	LEVANTESI Matteo	ITA	5,20							9.20		14,400	<b>14.400</b>
4.	024	MIR Nicolau	ESP	5,20							9.10		14,300	<b>14.300</b>
4.	040	CASALI Lorenzo Minh	ITA	5,20							9.10		14,300	<b>14.300</b>
6.	037	TANTALIDIS Antonios	GRE	5,20							9.00		14,200	<b>14.200</b>
7.	057	ARICAN Ferhat	TUR	5,20							9.00	-0.10	14,100	<b>14.100</b>
8.	017	ABDELRAHMAN Ahmed	EGY	5,20							8.85		14,050	<b>14.050</b>
9.	048	ALMEIDA Filipe	POR	5,20							8.80		14,000	<b>14.000</b>
10.	061	ONDER Ahmet	TUR	5,20							8.85	-0.10	13,950	<b>13.950</b>
11.	011	ANGONAS Georgios	CYP	4,80							9.10		13,900	<b>13.900</b>
12.	056	NAJJAR Lais	SYR	4,80							9.15	-0.10	13,850	<b>13.850</b>
13.	022	ABAD Nestor	ESP	4,80							9.05		13,850	<b>13.850</b>
13.	034	ILIOPOULOS Nikolaos	GRE	4,80							9.05		13,850	<b>13.850</b>
15.	021	MOHAMED Omar	EGY	5,20							8.95	-0.30	13,850	<b>13.850</b>
15.	002	METIDJI Hillal	ALG	5,20							8.95	-0.30	13,850	<b>13.850</b>



## RESULTS MEN'S VAULT 1

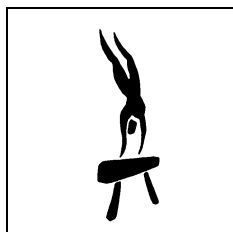

Rank	Bib	Nom Prénom Name Firstname	Fed	D	E1	E2	E3	E4	E5	E6	E	Pen.	Total	
17.	025	PLATA Joel	ESP	4,80							9.00		13,800	<b>13.800</b>
17.	029	BOULET Edgar	FRA	4,80							9.00		13,800	<b>13.800</b>
17.	036	KONSTANTINIDIS Christoforos	GRE	4,80							9.00		13,800	<b>13.800</b>
20.	003	BOURGUIEG Mohamed Abdeldja	ALG	4,80							8.90		13,700	<b>13.700</b>
21.	023	DIALLO Thierno	ESP	4,80							8.85		13,650	<b>13.650</b>
22.	046	CAMPOS Guilherme	POR	4,80							8.90	-0.10	13,600	<b>13.600</b>
23.	013	GEORGIU Marios	CYP	4,80							8.80		13,600	<b>13.600</b>
24.	042	LODADIO Marco	ITA	5,60							8.00		13,600	<b>13.600</b>
25.	033	SALEUR Julien	FRA	4,80							8.75		13,550	<b>13.550</b>
26.	058	ASIL Adem	TUR	5,60							8.00	-0.10	13,500	<b>13.500</b>
27.	031	PHILIPPE Mathias	FRA	4,00							9.30		13,300	<b>13.300</b>
28.	060	DEMIR Sercan	TUR	4,00							9.15		13,150	<b>13.150</b>
28.	006	BELLAOUI Bilal	ALG	4,00							9.15		13,150	<b>13.150</b>
30.	045	CROVETTO Kevin	MON	4,40							8.75		13,150	<b>13.150</b>
31.	032	SALADINO Leo	FRA	5,60							7.80	-0.30	13,100	<b>13.100</b>
32.	055	KHALIL Mohamad	SYR	4,00							9.00		13,000	<b>13.000</b>
33.	005	DJABER Hmida	ALG	4,00							8.95		12,950	<b>12.950</b>





## RESULTS MEN'S VAULT 1

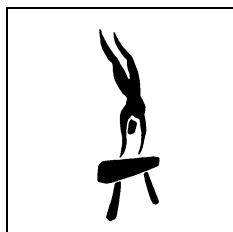

Rank	Bib	Nom Prénom Name Firstname	Fed	D	E1	E2	E3	E4	E5	E6	E	Pen.	Total	
34.	047	MARQUES Marcelo	POR	4,00							8.85		12,850	<b>12.850</b>
35.	050	VEFIC Petar	SRB	4,00							8.80	-0.10	12,700	<b>12.700</b>
36.	012	CHARI Michalis	CYP	4,80							7.85		12,650	<b>12.650</b>
37.	038	TSOLAKIDIS Stefanos	GRE	4,80							7.95	-0.30	12,450	<b>12.450</b>
38.	049	NOGUEIRA Jose	POR	3,20							9.05		12,250	<b>12.250</b>
39.	054	AL SOULIMAN Yazan	SYR	4,40							7.85	-0.30	11,950	<b>11.950</b>
40.	007	MALIC CORNI Sergej	BIH	3,20							8.70		11,900	<b>11.900</b>
41.	044	CITAKU Elvis	KOS	2,20							8.95		11,150	<b>11.150</b>
42.	009	VLAHEK Jakov	CRO	1,60							9.20		10,800	<b>10.800</b>
43.	020	KHATER Zaid	EGY	2,40							7.80		10,200	<b>10.200</b>



## RESULTS

### MEN'S VAULT 2 ATTEMPTS QUALIFICATION

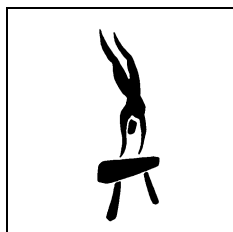

Rank	Bib	Nom Prénom Name Firstname	Fed	D	E1	E2	E3	E4	E5	E6	E	Pen.	Total		
1.	039	<b>BARTOLINI Nicola</b>	<b>ITA</b>	5,20							9.45		14,650	<b>14.350</b>	Q
				4,80							9.35	-0.10	14,050		
2.	041	<b>LEVANTESI Matteo</b>	<b>ITA</b>	5,20							9.20		14,400	<b>14.250</b>	Q
				4,80							9.30		14,100		
3.	061	<b>ONDER Ahmet</b>	<b>TUR</b>	5,20							8.85	-0.10	13,950	<b>14.150</b>	Q
				5,20							9.15		14,350		
4.	058	<b>ASIL Adem</b>	<b>TUR</b>	5,60							8.00	-0.10	13,500	<b>14.050</b>	Q
				5,60							9.00		14,600		
5.	056	<b>NAJJAR Lais</b>	<b>SYR</b>	4,80							9.15	-0.10	13,850	<b>13.575</b>	Q
				4,40							8.90		13,300		
6.	048	<b>ALMEIDA Filipe</b>	<b>POR</b>	5,20							8.80		14,000	<b>13.525</b>	Q
				4,00							9.05		13,050		
7.	021	<b>MOHAMED Omar</b>	<b>EGY</b>	5,20							8.95	-0.30	13,850	<b>13.525</b>	Q
				5,20							8.00		13,200		
8.	002	<b>METIDJI Hillal</b>	<b>ALG</b>	5,20							8.95	-0.30	13,850	<b>13.425</b>	Q
				4,00							9.00		13,000		
9.	046	<b>CAMPOS Guilherme</b>	<b>POR</b>	4,80							8.90	-0.10	13,600	<b>13.375</b>	R1
				4,00							9.15		13,150		
10.	003	<b>BOURGUIEG Mohamed Abdeldja</b>	<b>ALG</b>	4,80							8.90		13,700	<b>13.350</b>	R2
				4,00							9.00		13,000		
11.	011	<b>ANGONAS Georgios</b>	<b>CYP</b>	4,80							9.10		13,900	<b>13.100</b>	
				4,80							7.80	-0.30	12,300		
12.	032	<b>SALADINO Leo</b>	<b>FRA</b>	5,60							7.80	-0.30	13,100	<b>13.100</b>	
				5,20							7.90		13,100		
13.	049	<b>NOGUEIRA Jose</b>	<b>POR</b>	3,20							9.05		12,250	<b>12.725</b>	
				4,00							9.20		13,200		



## RESULTS

### MEN'S VAULT 2 ATTEMPTS QUALIFICATION

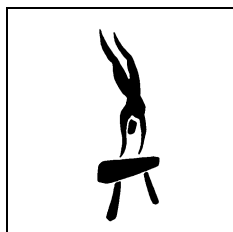

Rank	Bib	Nom Prénom Name Firstname	Fed	D	E1	E2	E3	E4	E5	E6	E	Pen.	Total
14.	050	VEFIC Petar	SRB	4,00							8.80	-0.10	12,700
				4,80							8.00	-0.20	12,600
15.	006	BELLAOUI Bilal	ALG	4,00							9.15		13,150
				4,40							7.95	-0.30	12,050
16.	007	MALIC CORNI Sergej	BIH	3,20							8.70		11,900
				4,00							8.55		12,550



## RESULTS

### MEN'S VAULT 2 ATTEMPTS QUALIFICATION

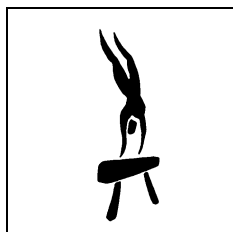

Rank	Bib	Nom Prénom Name Firstname	Fed	D	E1	E2	E3	E4	E5	E6	E	Score	Pen.	Total
41.	044	CITAKU Elvis	KOS	2,20							8.95			11,150
42.	009	VLAHEK Jakov	CRO	1,60							9.20			10,800
43.	020	KHATER Zaid	EGY	2,40							7.80			10,200



## RESULTS MEN'S PARALLEL BARS QUALIFICATION

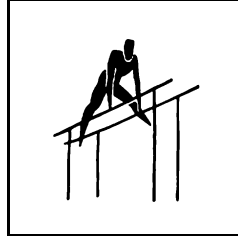

Rank	Bib	Nom Prénom Name Firstname	Fed	D	E1	E2	E3	E4	E5	E6	E	Pen.	Total
1.	061	ONDER Ahmet	TUR	6,40							8.75		15.150
2.	041	LEVANTESI Matteo	ITA	5,60							9.15		14.750
3.	028	BERNARD Cameron-Lie	FRA	6,30							8.35		14.650
4.	057	ARICAN Ferhat	TUR	6,50							7.95		14.450
5.	112	GIANNINI Lay	ITA	5,50							8.85		14.350
6.	031	PHILIPPE Mathias	FRA	6,10							8.20		14.300
7.	024	MIR Nicolau	ESP	5,50							8.75		14.250
8.	014	GEORGIOU Ilias	CYP	5,30							8.90		14.200
9.	040	CASALI Lorenzo Minh	ITA	5,60							8.55		14.150
10.	013	GEORGIOU Marios	CYP	5,80							8.30		14.100
11.	039	BARTOLINI Nicola	ITA	5,60							8.45		14.050
11.	058	ASIL Adem	TUR	5,60							8.45		14.050
13.	060	DEMIR Sercan	TUR	5,90							8.10		14.000
14.	023	DIALLO Thierno	ESP	5,90							8.00		13.900
15.	034	ILIOPOULOS Nikolaos	GRE	5,50							8.30		13.800
16.	021	MOHAMED Omar	EGY	5,60							8.10		13.700
17.	033	SALEUR Julien	FRA	5,20							8.45		13.650
18.	002	METIDJI Hillal	ALG	5,20							8.20		13.400
19.	020	KHATER Zaid	EGY	5,20							8.10		13.300
20.	022	ABAD Nestor	ESP	5,50							7.80		13.300
21.	037	TANTALIDIS Antonios	GRE	4,00							9.05		13.050
22.	011	ANGONAS Georgios	CYP	5,10							7.85		12.950
23.	050	VEFIC Petar	SRB	5,50							7.35		12.850

Report created THU 28 JUN 2022 13:51:56

Data Processing and Timing by Microplus — www.microplustiming.com



## RESULTS MEN'S PARALLEL BARS QUALIFICATION

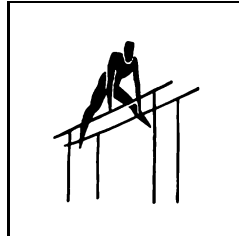

Rank	Bib	Nom Prénom Name Firstname	Fed	D	E1	E2	E3	E4	E5	E6	E	Score	Pen.	Total
24.	049	NOGUEIRA Jose	POR	4,10							8.70			12.800
25.	035	KANELLOS Apostolos	GRE	4,20							8.60			12.800
26.	017	ABDELRAHMAN Ahmed	EGY	4,70							8.05			12.750
27.	003	BOURGUIEG Mohamed Abdeldji	ALG	4,20							8.50			12.700
28.	005	DJABER Hmida	ALG	4,40							7.95			12.350
29.	048	ALMEIDA Filipe	POR	3,60							8.65			12.250
30.	045	CROVETTO Kevin	MON	3,80							8.45			12.250
31.	025	PLATA Joel	ESP	5,50							6.75			12.250
32.	006	BELLAOUI Bilal	ALG	3,80							8.10			11.900
33.	054	AL SOULIMAN Yazan	SYR	4,00							7.90			11.900
34.	047	MARQUES Marcelo	POR	3,70							8.00			11.700
35.	012	CHARI Michalis	CYP	3,90							7.70			11.600
36.	046	CAMPOS Guilherme	POR	3,80							7.75			11.550
37.	009	VLAHEK Jakov	CRO	2,60							8.60			11.200
38.	032	SALADINO Leo	FRA	5,40							5.50			10.900
39.	056	NAJJAR Lais	SYR	4,60							5.50			10.100
40.	055	KHALIL Mohamad	SYR	2,50							7.35	-3.00		6.850



## RESULTS MEN'S HORIZONTAL BAR QUALIFICATION

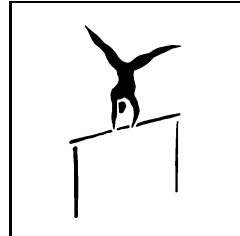

Rank	Bib	Nom Prénom Name Firstname	Fed	D	E1	E2	E3	E4	E5	E6	E	Pen.	Total
1.	058	ASIL Adem	TUR	5,40							8.40		13.800
2.	013	GEORGIU Marios	CYP	5,80							8.00		13.800
3.	019	ELMARAGHY Ahmed	EGY	5,30							8.35		13.650
4.	061	ONDER Ahmet	TUR	5,90							7.75		13.650
5.	041	LEVANTESI Matteo	ITA	5,10							8.50		13.600
6.	031	PHILIPPE Mathias	FRA	5,60							7.90		13.500
7.	024	MIR Nicolau	ESP	4,90							8.45		13.350
8.	034	ILIOPOULOS Nikolaos	GRE	5,20							8.15		13.350
9.	008	SRBIC Tin	CRO	5,30							8.05		13.350
10.	021	MOHAMED Omar	EGY	4,80							8.50		13.300
11.	039	BARTOLINI Nicola	ITA	4,50							8.75		13.250
12.	022	ABAD Nestor	ESP	4,90							8.35		13.250
13.	040	CASALI Lorenzo Minh	ITA	5,00							8.25		13.250
14.	029	BOULET Edgar	FRA	5,40							7.85		13.250
15.	112	GIANNINI Lay	ITA	4,80							8.40		13.200
16.	033	SALEUR Julien	FRA	4,70							8.45		13.150
17.	017	ABDELRAHMAN Ahmed	EGY	4,60							8.50		13.100
18.	060	DEMIR Sercan	TUR	4,80							8.30		13.100
19.	014	GEORGIU Ilias	CYP	5,30							7.75		13.050
20.	011	ANGONAS Georgios	CYP	4,60							8.30		12.900
21.	002	METIDJI Hillal	ALG	4,40							8.35		12.750
22.	057	ARICAN Ferhat	TUR	4,70							8.00		12.700
23.	049	NOGUEIRA Jose	POR	4,20							8.45		12.650

Report created THU 28 JUN 2022 13:52:26

Data Processing and Timing by Microplus — [www.microplustiming.com](http://www.microplustiming.com)



## RESULTS MEN'S HORIZONTAL BAR QUALIFICATION

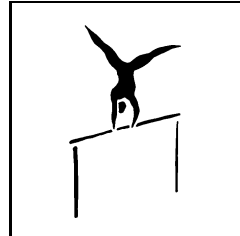

Rank	Bib	Nom Prénom Name Firstname	Fed	D	E1	E2	E3	E4	E5	E6	E	Score	Pen.	Total
24.	056	NAJJAR Lais	SYR	4,20							8.40			12.600
25.	035	KANELLOS Apostolos	GRE	4,70							7.85			12.550
26.	048	ALMEIDA Filipe	POR	3,60							8.85			12.450
27.	020	KHATER Zaid	EGY	4,50							7.90			12.400
28.	051	DEJANOVIC Ivan	SRB	5,00							7.20			12.200
29.	003	BOURGUIEG Mohamed Abdeldj	ALG	4,10							7.95			12.050
30.	047	MARQUES Marcelo	POR	3,40							8.55			11.950
31.	037	TANTALIDIS Antonios	GRE	4,10							7.75			11.850
32.	025	PLATA Joel	ESP	5,20							6.65			11.850
33.	032	SALADINO Leo	FRA	4,50							7.20			11.700
34.	006	BELLAOUI Bilal	ALG	4,00							7.65			11.650
35.	023	DIALLO Thierno	ESP	4,70							6.95			11.650
36.	046	CAMPOS Guilherme	POR	3,70							7.90			11.600
37.	012	CHARI Michalis	CYP	3,80							7.70			11.500
38.	050	VEFIC Petar	SRB	4,50							7.00			11.500
39.	045	CROVETTO Kevin	MON	3,80							7.35			11.150
40.	054	AL SOULIMAN Yazan	SYR	3,20							6.80			10.000
41.	005	DJABER Hmida	ALG	4,00							5.55			9.550
42.	009	VLAHEK Jakov	CRO	1,40							9.00	-6.00		4.400





### Tie Break Report - men's qualifications



#### Floor

Rank	Bib	Name	NOC Code	Total	Execution Score	Difficulty Score
9	060	DEMIR Sercan	TUR	13.450	8.15	
10	013	GEORGIU Marios	CYP	13.450	7.85	
11	031	PHILIPPE Mathias	FRA	13.350	7.95	5.40
11	046	CAMPOS Guilherme	POR	13.350	7.95	5.40
17	048	ALMEIDA Filipe	POR	12.950	8.25	
18	056	NAJJAR Lais	SYR	12.950	8.05	
19	006	BELLAOUI Bilal	ALG	12.850	8.35	
20	027	WILLIAMS Joshua Jack	ESP	12.850	8.15	



### Tie Break Report - men's qualifications



### Pommels Horse

Rank	Bib	Name	NOC Code	Total	Execution Score	Difficulty Score
10	033	SALEUR Julien	FRA	13.600	8.50	
11	021	MOHAMED Omar	EGY	13.600	8.30	
17	040	CASALI Lorenzo Minh	ITA	12.950	8.35	
18	002	METIDJI Hillal	ALG	12.950	8.05	
19	020	KHATER Zaid	EGY	12.950	7.85	
20	047	MARQUES Marcelo	POR	12.950	7.75	
21	031	PHILIPPE Mathias	FRA	12.650	8.25	
22	041	LEVANTESI Matteo	ITA	12.650	7.95	
27	014	GEORGIOU Ilias	CYP	12.400	8.00	
28	004	YOUSFI Mohamed Amine	ALG	12.400	7.00	
32	050	VEFIC Petar	SRB	11.600	7.80	
33	005	DJABER Hmida	ALG	11.600	7.70	
34	035	KANELLOS Apostolos	GRE	11.600	5.90	
35	046	CAMPOS Guilherme	POR	11.400	7.90	
36	012	CHARI Michalis	CYP	11.400	7.40	



Tie Break Report - men's qualifications



Vault 1

Rank	Bib	Name	NOC Code	Total	Execution Score	Difficulty Score
2	041	LEVANTES! Matteo	ITA	14.400	9.20	5.20
2	014	GEORGIOU Ilias	CYP	14.400	9.20	5.20
4	024	MIR Nicolau	ESP	14.300	9.10	5.20
4	040	CASALI Lorenzo Minh	ITA	14.300	9.10	5.20
12	056	NAJJAR Lais	SYR	13.850	9.15	
13	022	ABAD Nestor	ESP	13.850	9.05	4.80
13	034	ILIOPOULOS Nikolaos	GRE	13.850	9.05	4.80
15	021	MOHAMED Omar	EGY	13.850	8.95	5.20
15	002	METIDJI Hillal	ALG	13.850	8.95	5.20
17	025	PLATA Joel	ESP	13.800	9.00	4.80
17	029	BOULET Edgar	FRA	13.800	9.00	4.80
17	036	KONSTANTINIDIS Christoforos	GRE	13.800	9.00	4.80
22	046	CAMPOS Guilherme	POR	13.600	8.90	
23	013	GEORGIOU Marios	CYP	13.600	8.80	
24	042	LODADIO Marco	ITA	13.600	8.00	
28	060	DEMIR Sercan	TUR	13.150	9.15	4.00
28	006	BELLAOUI Bilal	ALG	13.150	9.15	4.00
30	045	CROVETTO Kevin	MON	13.150	8.75	
31	032	SALADINO Leo FRA	FRA	13.150	7.80	



### Tie Break Report - men's qualifications



### Vault Qualification

Rank	Bib	Name	NOC Code	Total	Highest Vault	Highest Execution Score	Highest Difficulty Score
6	048	ALMEIDA Filipe	POR	13.525	14.000		
7	021	MOHAMED Omar	EGY	13.525	13.850		
11	011	ANGONAS Georgios	CYP	13.100	13.900		
12	032	SALADINO Leo	FRA	13.100	13.100		



### Tie Break Report - men's qualifications



#### Parallel Bars

Rank	Bib	Name	NOC Code	Total	Execution Score	Difficulty Score
11	039	BARTOLINI Nicola	ITA	14.050	8.45	5.60
11	058	ASIL Adem	TUR	14.050	8.45	5.60
19	020	KHATER Zaid	EGY	13.300	8.10	
20	022	ABAD Nestor	ESP	13.300	7.80	
24	049	NOGUEIRA Jose	POR	12.800	8.70	
25	035	KANELLOS Apostolos	GRE	12.800	8.60	
29	048	ALMEIDA Filipe	POR	12.250	8.65	
30	045	CROVETTO Kevin	MON	12.250	8.45	
31	025	PLATA Joel	ESP	12.250	6.75	
32	006	BELLAOUI Bilal	ALG	11.900	8.10	
33	054	AL SOULIMAN Yazan	SYR	11.900	7.90	



### Tie Break Report - men's qualifications



#### Horizontal Bar

Rank	Bib	Name	NOC Code	Total	Execution Score	Difficulty Score
1	058	ASIL Adem	TUR	13.800	8.40	
2	013	GEORGIOU Marios	CYP	13.800	8.00	
3	019	ELMARAGHY Ahmed	EGY	13.650	8.35	
4	061	ONDER Ahmet	TUR	13.650	7.75	
7	024	MIR Nicolau	ESP	13.350	8.45	
8	034	ILIOPOULOS Nikolaos	GRE	13.350	8.15	
9	008	SRBIC Tin	CRO	13.350	8.05	
11	039	BARTOLINI Nicola	ITA	13.250	8.75	
12	022	ABAD Nestor	ESP	13.250	8.35	
13	040	CASALI Lorenzo Minh	ITA	13.250	8.25	
14	029	BOULET Edgar	FRA	13.250	7.85	
31	037	TANTALIDIS Antonios	GRE	11.850	7.75	
32	025	PLATA Joel	ESP	11.850	6.65	
34	006	BELLAOUI Bilal	ALG	11.650	7.65	
35	023	DIALLO Thierno	ESP	11.650	6.95	
37	012	CHARI Michalis	CYP	11.500	7.70	
38	050	VEFIC Petar	SRB	11.500	7.00	



**MEN'S INDIVIDUAL ALL-AROUND  
LIST OF QUALIFIERS**

Qualifying Order	Bib	Name	NOC Code	Qual. Score
1	061	ONDER Ahmet	TUR	84,050
2	058	ASIL Adem	TUR	83,650
3	039	BARTOLINI Nicola	ITA	83,150
4	021	MOHAMED Omar	EGY	82,750
5	013	GEORGIOU Marios	CYP	82,450
6	024	MIR Nicolau	ESP	81,400
7	040	CASALI Lorenzo Minh	ITA	81,250
8	031	PHILIPPE Mathias	FRA	80,800
9	037	TANTALIDIS Antonios	GRE	79,650
10	034	ILIOPOULOS Nikolaos	GRE	79,500
11	025	PLATA Joel	ESP	78,500
12	002	METIDJI Hillal	ALG	77,500
13	048	ALMEIDA Filipe	POR	77,150
14	017	ABDELRAHMAN Ahmed	EGY	76,900
15	049	NOGUEIRA Jose	POR	76,400
16	056	NAJJAR Lais	SYR	75,650
17	032	SALADINO Leo	FRA	74,900
18	011	ANGONAS Georgios	CYP	73,800
19	003	BOURGUIEG Mohamed Abdeldjalil	ALG	72,400
20	045	CROVETTO Kevin	MON	71,650
21	050	VEFIC Petar	SRB	70,900
22	054	AL SOULIMAN Yazan	SYR	67,350
23	009	VLAHEK Jakov	CRO	53,850



## All Around Final Men Draw

Rotation	FLOOR	POMMELS HORSE	RINGS	VAULT	PARALLEL BARS	HORIZONTAL BAR
1	7-6-5-4	15-14-13-12	23-22-21-20			
	3-2-1-8	11-10-9-16	19-18-17-24			
2		6-5-4-3	14-13-12-11	22-21-20-19		
		2-1-8-7	10-9-16-15	18-17-24-23		
3			5-4-3-2	13-12-11-10	21-20-19-18	
			1-8-7-6	9-16-15-14	17-24-23-22	
4				4-3-2-1	12-11-10-9	20-19-18-17
				8-7-6-5	16-15-14-13	24-23-22-21
5	19-18-17-24				3-2-1-8	11-10-9-16
	23-22-21-20				7-6-5-4	15-14-13-12
6	10-9-16-15	18-17-24-23				2-1-8-7
	14-13-12-11	21-21-20-19				6-5-4-3





REVISED 28 JUN  
17:15

## START LIST

Men's Individual All-Around Final

### ROTATION 1 of 6

28 June 2022 - 16:00 to 16:30

#### FLOOR

Bib Name	NOC Code
040 CASALI Lorenzo Minh	ITA
024 MIR Nicolau	ESP
013 GEORGIU Marios	CYP
021 MOHAMED Omar	EGY
039 BARTOLINI Nicola	ITA
058 ASIL Adem	TUR
060 DEMIR Sercan	TUR
031 PHILIPPE Mathias	FRA

#### POMMELS HORSE

Bib Name	NOC Code
049 NOGUEIRA Jose	POR
048 ALMEIDA Filipe	POR
025 PLATA Joel	ESP
034 ILIOPOULOS Nikolaos	GRE
037 TANTALIDIS Antonios	GRE
056 NAJJAR Lais	SYR

#### RINGS

Bib Name	NOC Code
054 AL SOULIMAN Yazan	SYR
050 VEFIC Petar	SRB
045 CROVETTO Kevin	MON
011 ANGONAS Georgios	CYP
032 SALADINO Leo	FRA
005 DJABER HMIDA	ALG

#### VAULT

Bib Name	NOC Code
----------	----------

#### PARALLEL BARS

Bib Name	NOC Code
----------	----------

#### HORIZONTAL BAR

Bib Name	NOC Code
----------	----------



## START LIST

Men's Individual All-Around Final

ROTATION 2 of 6

28 June 2022 - 16:30 to 17:00

### FLOOR

Bib Name	NOC Code
----------	----------

### POMMELS HORSE

Bib Name	NOC Code
024 MIR Nicolau	ESP
013 GEORGIOU Marios	CYP
021 MOHAMED Omar	EGY
039 BARTOLINI Nicola	ITA
058 ASIL Adem	TUR
060 DEMIR Sercan	TUR
031 PHILIPPE Mathias	FRA
040 CASALI Lorenzo Minh	ITA

### RINGS

Bib Name	NOC Code
048 ALMEIDA Filipe	POR
025 PLATA Joel	ESP
034 ILIOPOULOS Nikolaos	GRE
037 TANTALIDIS Antonios	GRE
056 NAJJAR Lais	SYR
049 NOGUEIRA Jose	POR

### VAULT

Bib Name	NOC Code
054 AL SOULIMAN Yazan	SYR
050 VEFIC Petar	SRB
045 CROVETTO Kevin	MON
011 ANGONAS Georgios	CYP
032 SALADINO Leo	FRA
005 DJABER HMIDA	ALG

### PARALLEL BARS

Bib Name	NOC Code
----------	----------

### HORIZONTAL BAR

Bib Name	NOC Code
----------	----------



## START LIST

Men's Individual All-Around Final

ROTATION 3 of 6

28 June 2022 - 17:00 to 17:30

### FLOOR

Bib Name	NOC Code
----------	----------

### POMMELS HORSE

Bib Name	NOC Code
----------	----------

### RINGS

Bib Name	NOC Code
013 GEORGIYOU Marios	CYP
021 MOHAMED Omar	EGY
039 BARTOLINI Nicola	ITA
058 ASIL Adem	TUR
060 DEMIR Sercan	TUR
031 PHILIPPE Mathias	FRA
040 CASALI Lorenzo Minh	ITA
024 MIR Nicolau	ESP

### VAULT

Bib Name	NOC Code
048 ALMEIDA Filipe	POR
025 PLATA Joel	ESP
034 ILIOPOULOS Nikolaos	GRE
037 TANTALIDIS Antonios	GRE
056 NAJJAR Lais	SYR
049 NOGUEIRA Jose	POR

### PARALLEL BARS

Bib Name	NOC Code
050 VEFIC Petar	SRB
045 CROVETTO Kevin	MON
011 ANGONAS Georgios	CYP
032 SALADINO Leo	FRA
054 AL SOULIMAN Yazan	SYR
005 DJABER HMIDA	ALG

### HORIZONTAL BAR

Bib Name	NOC Code
----------	----------



## START LIST

Men's Individual All-Around Final

ROTATION 4 of 6

28 June 2022 - 17:30 to 18:00

### FLOOR

Bib Name	NOC Code
----------	----------

### POMMELS HORSE

Bib Name	NOC Code
----------	----------

### RINGS

Bib Name	NOC Code
----------	----------

### VAULT

Bib Name	NOC Code
021 MOHAMED Omar	EGY
039 BARTOLINI Nicola	ITA
058 ASIL Adem	TUR
060 DEMIR Sercan	TUR
031 PHILIPPE Mathias	FRA
040 CASALI Lorenzo Minh	ITA
024 MIR Nicolau	ESP
013 GEORGIU Marios	CYP

### PARALLEL BARS

Bib Name	NOC Code
025 PLATA Joel	ESP
034 ILIOPOULOS Nikolaos	GRE
037 TANTALIDIS Antonios	GRE
056 NAJJAR Lais	SYR
049 NOGUEIRA Jose	POR
048 ALMEIDA Filipe	POR

### HORIZONTAL BAR

Bib Name	NOC Code
045 CROVETTO Kevin	MON
011 ANGONAS Georgios	CYP
032 SALADINO Leo	FRA
054 AL SOULIMAN Yazan	SYR
050 VEFIC Petar	SRB
005 DJABER HMIDA	ALG



## START LIST

Men's Individual All-Around Final

ROTATION 5 of 6

28 June 2022 - 18:00 to 18:30

### FLOOR

Bib Name	NOC Code
011 ANGONAS Georgios	CYP
032 SALADINO Leo	FRA
054 AL SOULIMAN Yazan	SYR
050 VEFIC Petar	SRB
045 CROVETTO Kevin	MON
005 DJABER HMIDA	ALG

### POMMELS HORSE

Bib Name	NOC Code
----------	----------

### RINGS

Bib Name	NOC Code
----------	----------

### VAULT

Bib Name	NOC Code
----------	----------

### PARALLEL BARS

Bib Name	NOC Code
039 BARTOLINI Nicola	ITA
058 ASIL Adem	TUR
060 DEMIR Sercan	TUR
031 PHILIPPE Mathias	FRA
040 CASALI Lorenzo Minh	ITA
024 MIR Nicolau	ESP
013 GEORGIU Marios	CYP
021 MOHAMED Omar	EGY

### HORIZONTAL BAR

Bib Name	NOC Code
025 PLATA Joel	ESP
034 ILIOPOULOS Nikolaos	GRE
037 TANTALIDIS Antonios	GRE
056 NAJJAR Lais	SYR
049 NOGUEIRA Jose	POR
048 ALMEIDA Filipe	POR



## START LIST

Men's Individual All-Around Final

ROTATION 6 of 6

28 June 2022 - 18:30 to 19:00

### FLOOR

Bib Name	NOC Code
034 ILIOPOULOS Nikolaos	GRE
037 TANTALIDIS Antonios	GRE
056 NAJJAR Lais	SYR
049 NOGUEIRA Jose	POR
048 ALMEIDA Filipe	POR
025 PLATA Joel	ESP

### POMMELS HORSE

Bib Name	NOC Code
011 ANGONAS Georgios	CYP
032 SALADINO Leo	FRA
054 AL SOULIMAN Yazan	SYR
050 VEFIC Petar	SRB
045 CROVETTO Kevin	MON
005 DJABER HMIDA	ALG

### RINGS

Bib Name	NOC Code
----------	----------

### VAULT

Bib Name	NOC Code
----------	----------

### PARALLEL BARS

Bib Name	NOC Code
----------	----------

### HORIZONTAL BAR

Bib Name	NOC Code
058 ASIL Adem	TUR
060 DEMIR Sercan	TUR
031 PHILIPPE Mathias	FRA
040 CASALI Lorenzo Minh	ITA
024 MIR Nicolau	ESP
013 GEORGIOU Marios	CYP
021 MOHAMED Omar	EGY
039 BARTOLINI Nicola	ITA



19th MEDITERANIAN GAMES  
26 - 29 JUNE 2022 ORAN, ALGERIA



## JUDGES ASSIGNMENT

### ALL AROUND

#### Competition Jury

Arturs Mickevics FIG



Number	JUDGES		Nation
--------	--------	--	--------

<b>D1</b>	DIAZ LOZA	ROBERTO JAVIER	ESP
<b>D2</b>	MANDICH	FLAVIO	ITA
<b>E1</b>	ABDELHAMID ELNADY	HESHAM	EGY
<b>E2</b>	STYLIANOU	SOTIRIS	CYP
<b>E3</b>	HADJI	ABDELMADJID	ALG
<b>E4</b>	TURKDOGAN	SENL	TUR
<b>T</b>	OUCHÉFOUN	MAHFOUDH	ALG
<b>L1</b>	KAID-SLIMANE	MAHAMMED SALIM	ALG
<b>L2</b>	BENNILA	ABDELKADER	ALG



Number	JUDGES		Nation
--------	--------	--	--------

<b>D1</b>	HODZIC LEDERER	ENES	SLO
<b>D2</b>	OZGOREN	ZIYA	TUR
<b>E1</b>	LE ROCH	TANGUY	FRA
<b>E2</b>	VUKOVIC	RATKO	CRO
<b>E3</b>	MAHMOUD	ARAFAT	EGY
<b>E4</b>	MOUDJEB	MISSOUM	ALG



Number	JUDGES		Nation
--------	--------	--	--------

<b>D1</b>	HADJI	MOHAMMED SAMIL	ALG
<b>D2</b>	ALYOUSEF	NEDAL	SYR
<b>E1</b>	TOR FERREIRA DA CC	MANUEL	POR
<b>E2</b>	MIKES	GEZA	SRB
<b>E3</b>	JOVANOVIC	DEJAN	SLO
<b>E4</b>	BARBOLINI	UBER	ITA



Number	JUDGES		Nation
--------	--------	--	--------

<b>D1</b>	DIAZ LOZA	ROBERTO JAVIER	ESP
<b>D2</b>	MANDICH	FLAVIO	ITA
<b>E1</b>	ABDELHAMID ELNADY	HESHAM	EGY
<b>E2</b>	STYLIANOU	SOTIRIS	CYP
<b>E3</b>	HADJI	ABDELMADJID	ALG
<b>E4</b>	TURKDOGAN	SENL	TUR
<b>L</b>	KAID-SLIMANE	MAHAMMED SALIM	ALG



Number	JUDGES		Nation
--------	--------	--	--------

<b>D1</b>	HODZIC LEDERER	ENES	SLO
<b>D2</b>	OZGOREN	ZIYA	TUR
<b>E1</b>	LE ROCH	TANGUY	FRA
<b>E2</b>	VUKOVIC	RATKO	CRO
<b>E3</b>	MAHMOUD	ARAFAT	EGY
<b>E4</b>	MOUDJEB	MISSOUM	ALG
<b>T</b>	BAXEVANIDIS	DIMITRIOS	GRE



Number	JUDGES		Nation
--------	--------	--	--------

<b>D1</b>	HADJI	MOHAMMED SAMIL	ALG
<b>D2</b>	ALYOUSEF	NEDAL	SYR
<b>E1</b>	ABDELHAMID ELNADY	HESHAM	EGY
<b>E2</b>	STYLIANOU	SOTIRIS	CYP
<b>E3</b>	HADJI	ABDELMADJID	ALG
<b>E4</b>	TURKDOGAN	SENL	TUR







R1

R1



**MEDITERRANEAN GAMES  
ORAN 2022**

**RESULTS  
MEN'S ALL-AROUND FINAL**

Rank	Bib	Name	NOC Code							Total
1	058	ASIL Adem	TUR	14,050	13,250	14,950	14,850	14,100	13,500	<b>84,700</b>
2	025	PLATA Joel	ESP	13,800	13,600	13,300	14,050	13,850	13,350	<b>81,950</b>
3	013	GEORGIOU Marios	CYP	12,850	12,800	13,700	14,100	14,300	14,050	<b>81,800</b>
4	021	MOHAMED Omar	EGY	14,100	13,600	14,000	14,450	13,300	12,150	<b>81,600</b>
5	040	CASALI Lorenzo Minh	ITA	13,150	13,000	13,500	14,600	14,100	13,250	<b>81,600</b>
6	024	MIR Nicolau	ESP	13,700	12,350	13,350	14,250	13,950	13,350	<b>80,950</b>
7	039	BARTOLINI Nicola	ITA	14,200	13,100	13,100	13,200	13,950	13,300	<b>80,850</b>
8	034	ILIOPOULOS Nikolaos	GRE	12,900	12,550	13,250	13,800	13,850	13,550	<b>79,900</b>
9	037	TANTALIDIS Antonios	GRE	13,650	14,000	12,700	14,000	13,050	12,450	<b>79,850</b>
10	060	DEMIR Sercan	TUR	13,100	12,250	13,500	13,050	14,250	12,850	<b>79,000</b>
11	032	SALADINO Leo	FRA	13,550	11,500	13,650	14,750	12,200	12,750	<b>78,400</b>
12	049	NOGUEIRA Jose	POR	13,600	12,250	12,750	13,750	12,800	12,600	<b>77,750</b>
13	031	PHILIPPE Mathias	FRA	13,750	10,950	13,400	13,150	13,100	13,250	<b>77,600</b>
14	011	ANGONAS Georgios	CYP	13,150	11,200	12,500	13,900	13,650	12,950	<b>77,350</b>
15	005	DJABER Hmida	ALG	13,450	11,600	12,350	13,200	12,700	11,600	<b>74,900</b>
16	048	ALMEIDA Filipe	POR	13,200	12,350	12,800	13,100	10,100	12,050	<b>73,600</b>
17	045	CROVETTO Kevin	MON	12,150	11,400	12,150	13,300	12,300	12,300	<b>73,600</b>
18	050	VEFIC Petar	SRB	12,950	12,000	12,450	12,650	12,050	11,300	<b>73,400</b>
19	056	NAJJAR Lais	SYR	13,450	11,700	12,000	14,050	13,700	6,550	<b>71,450</b>
20	054	AL SOULIMAN Yazan	SYR	12,350	11,900	11,250	10,900	12,450	10,450	<b>69,300</b>





**Tie Break Report – men's qualifications  
All Around Final**

Rk	Bib	Name	NOC Code	Total	Sum of best scores					
					6	5	4	3	2	1
4	021	MOHAMED Omar	EGY	81.600	69.450					
5	040	CASALI Lorenzo Minh	ITA	81.600	68.600					
16	048	ALMEIDA Filipe	POR	73.600	63.500					
17	045	CROVETTO Kevin	MON	73.600	62.200					



## Men's Apparatus Finals Draws

Floor Exercise	
Qualifying order	Final order
7	1
2	2
6	3
8	4
5	5
1	6
3	7
4	8

Pommel Horse	
Qualifying order	Final order
8	1
2	2
6	3
1	4
7	5
3	6
5	7
4	8

Rings	
Qualifying order	Final order
4	1
6	2
7	3
3	4
2	5
8	6
1	7
5	8

Vault	
Qualifying order	Final order
4	1
3	2
2	3
5	4
7	5
6	6
8	7
1	8

Parallel Bars	
Qualifying order	Final order
4	1
2	2
3	3
7	4
5	5
8	6
1	7
6	8

Horizontal Bar	
Qualifying order	Final order
5	1
1	2
8	3
3	4
4	5
6	6
7	7
2	8



**START LISTS**  
**MEN'S APPARATUS FINALS**

**REVISED 29 JUN**  
**10:45**

	Bib	Name	NOC Code	Qual. Score
1	025	PLATA Joel	ESP	13,800
2	058	ASIL Adem	TUR	14,400
3	037	TANTALIDIS Antonios	GRE	13,700
4	029	BOULET Edgar	FRA	13,600
5	024	MIR Nicolau	ESP	13,900
6	061	ONDER Ahmet	TUR	14,250
7	039	BARTOLINI Nicola	ITA	14,600
8	021	MOHAMED Omar	EGY	14,000

**Reserves**

<b>R1</b>	013	GEORGIU Marios	CYP	13,450
<b>R2</b>	031	PHILIPPE Mathias	FRA	13,350
<b>R2</b>	046	CAMPOS Guilherme	POR	13,350

	Bib	Name	NOC Code	Qual. Score
1	009	VLAHEK Jakov	CRO	14,000
2	037	TANTALIDIS Antonios	GRE	14,300
3	057	ARICAN Ferhat	TUR	13,800
4	039	BARTOLINI Nicola	ITA	13,700
5	023	DIALLO Thierno	ESP	13,750
6	013	GEORGIU Marios	CYP	14,200
7	001	PETROV Matvei	ALB	13,950
8	010	ZUGEC Mateo	CRO	14,350

**Reserves**

<b>R1</b>	056	NAJJAR Lais	SYR	13,650
<b>R2</b>	033	SALEUR Julien	FRA	13,600

	Bib	Name	NOC Code	Qual. Score
1	031	PHILIPPE Mathias	FRA	13,700
2	018	ZHRAN Ali	EGY	14,300
3	021	MOHAMED Omar	EGY	14,300
4	059	COLAK Ibrahim	TUR	14,650
5	032	SALADINO Leo	FRA	13,600
6	042	LODADIO Marco	ITA	14,600
7	058	ASIL Adem	TUR	14,600
8	034	ILIOPOULOS Nikolaos	GRE	13,500

**Reserves**

<b>R1</b>	022	ABAD Nestor	ESP	13,350
<b>R2</b>	025	PLATA Joel	ESP	13,350

	Bib	Name	NOC Code	Qual. Score
1	046	CAMPOS Guilherme	POR	13,375
2	061	ONDER Ahmet	TUR	14,150
3	041	LEVANTESI Matteo	ITA	14,250
4	039	BARTOLINI Nicola	ITA	14,350
5	058	ASIL Adem	TUR	14,050
6	048	ALMEIDA Filipe	POR	13,525
7	056	NAJJAR Lais	SYR	13,575
8	021	MOHAMED Omar	EGY	13,525

**Reserves**

<b>R1</b>	003	BOURGUIEG Mohamed Abdeldja	ALG	13,350
<b>R2</b>	011	ANGONAS Georgios	CYP	13,100

	Bib	Name	NOC Code	Qual. Score
1	024	MIR Nicolau	ESP	14,250
2	041	LEVANTESI Matteo	ITA	14,750
3	028	BERNARD Cameron-Lie	FRA	14,650
4	061	ONDER Ahmet	TUR	15,150
5	112	GIANNINI Lay	ITA	14,350
6	014	GEORGIU Ilias	CYP	14,200
7	057	ARICAN Ferhat	TUR	14,450
8	031	PHILIPPE Mathias	FRA	14,300

**Reserves**

<b>R1</b>	013	GEORGIU Marios	CYP	14,100
<b>R2</b>	023	DIALLO Thierno	ESP	13,900

	Bib	Name	NOC Code	Qual. Score
1	013	GEORGIU Marios	CYP	13,800
2	034	ILIOPOULOS Nikolaos	GRE	13,350
3	061	ONDER Ahmet	TUR	13,650
4	041	LEVANTESI Matteo	ITA	13,600
5	058	ASIL Adem	TUR	13,800
6	031	PHILIPPE Mathias	FRA	13,500
7	024	MIR Nicolau	ESP	13,350
8	019	ELMARAGHY Ahmed	EGY	13,650

**Reserves**

<b>R1</b>	008	SRBIC Tin	CRO	13,350
<b>R2</b>	021	MOHAMED Omar	EGY	13,300

Report created THU 28 JUN 2022 12:27:09

Data Processing and Timing by Microplus — www.microplustiming.com



19th MEDITERANIAN GAMES  
26 - 29 JUNE 2022 ORAN, ALGERIA



## JUDGES ASSIGNMENT

### APPARATUS FINALS

#### Competition Jury

Arturs Mickevics FIG



Number	JUDGES		Nation
--------	--------	--	--------

<b>D1</b>	DIAZ LOZA	ROBERTO JAVIER	ESP
<b>D2</b>	MANDICH	FLAVIO	ITA
<b>E1</b>	VUKOVIC	RATKO	CRO
<b>E2</b>	HADJI	MOHAMMED SAMIL	ALG
<b>E3</b>	JOVANOVIC	DEJAN	SLO
<b>E4</b>	MIKES	GEZA	SRB
<b>T</b>	OUCHFOUN	MAHFOUDH	ALG
<b>L1</b>	BENNILA	ABDELKADER	ALG
<b>L2</b>	KAID-SLIMANE	MAHAMMED SALIM	ALG



Number	JUDGES		Nation
--------	--------	--	--------

<b>D1</b>	HODZIC LEDERER	ENES	SLO
<b>D2</b>	OZGOREN	ZIYA	TUR
<b>E1</b>	MAHMOUD	ARAFAT	EGY
<b>E2</b>	STOR FERREIRA DA COS	MANUEL	POR
<b>E3</b>	MOUDJEB	MISSOUM	ALG
<b>E4</b>	MIKES	GEZA	SRB



Number	JUDGES		Nation
--------	--------	--	--------

<b>D1</b>	HADJI	MOHAMMED SAMIL	ALG
<b>D2</b>	ALYOUSEF	NEDAL	SYR
<b>E1</b>	STOR FERREIRA DA COS	MANUEL	POR
<b>E2</b>	MIKES	GEZA	SRB
<b>E3</b>	ANGONAS	DIMITRIOS	CYP
<b>E4</b>	VUKOVIC	RATKO	CRO



Number	JUDGES		Nation
--------	--------	--	--------

<b>D1</b>	DIAZ LOZA	ROBERTO JAVIER	ESP
<b>D2</b>	MANDICH	FLAVIO	ITA
<b>E1</b>	MIKES	GEZA	SRB
<b>E2</b>	JOVANOVIC	DEJAN	SLO
<b>E3</b>	VUKOVIC	RATKO	CRO
<b>E4</b>	LE ROCH	TANGUY	FRA
<b>L</b>	BENNILA	ABDELKADER	ALG



Number	JUDGES		Nation
--------	--------	--	--------

<b>D1</b>	HODZIC LEDERER	ENES	SLO
<b>D2</b>	OZGOREN	ZIYA	TUR
<b>E1</b>	MOUDJEB	MISSOUM	ALG
<b>E2</b>	VUKOVIC	RATKO	CRO
<b>E3</b>	STOR FERREIRA DA COS	MANUEL	POR
<b>E4</b>	MAHMOUD	ARAFAT	EGY
<b>T</b>	BAXEVANIDIS	DIMITRIOS	GRE



Number	JUDGES		Nation
--------	--------	--	--------

<b>D1</b>	HADJI	MOHAMMED SAM	ALG
<b>D2</b>	ALYOUSEF	NEDAL	SYR
<b>E1</b>	JOVANOVIC	DEJAN	SLO
<b>E2</b>	STOR FERREIRA DA COS	MANUEL	POR
<b>E3</b>	MIKES	GEZA	SRB
<b>E4</b>	VUKOVIC	RATKO	CRO

R1

R1



## RESULTS

### MEN'S FLOOR EXERCISE FINAL

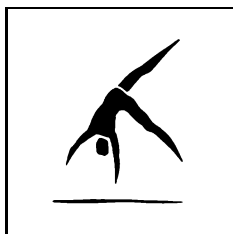

Rank	Bib	Name	NOC Code	D Score	E Score	Pen.	Total
1	039	BARTOLINI Nicola	ITA	5.900	8,950		<b>14,850</b>
2	061	ONDER Ahmet	TUR	5.800	8,500		<b>14,300</b>
3	058	ASIL Adem	TUR	5.800	8,400		<b>14,200</b>
4	024	MIR Nicolau	ESP	5.300	8,800		<b>14,100</b>
5	025	PLATA Joel	ESP	5.600	8,500		<b>14,100</b>
6	021	MOHAMED Omar	EGY	5.500	8,500		<b>14,000</b>
7	037	TANTALIDIS Antonios	GRE	5.600	8,200		<b>13,800</b>
8	029	BOULET Edgar	FRA	5.900	7,750		<b>13,650</b>



## RESULTS MEN'S POMMEL HORSE FINAL

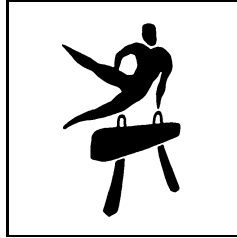

Rank	Bib	Name	NOC Code	D Score	E Score	Pen.	Total
1	010	ZUGEK Mateo	CRO	5.500	8,750		<b>14,250</b>
2	009	VLAHEK Jakov	CRO	5.700	8,450		<b>14,150</b>
3	057	ARICAN Ferhat	TUR	5.800	8,200		<b>14,000</b>
4	039	BARTOLINI Nicola	ITA	5.500	8,450		<b>13,950</b>
5	023	DIALLO Thierno	ESP	5.800	8,150		<b>13,950</b>
6	001	PETROV Matvei	ALB	5.300	8,100		<b>13,400</b>
7	013	GEORGIOU Marios	CYP	6.200	6,650		<b>12,850</b>
8	037	TANTALIDIS Antonios	GRE	4.800	7,350		<b>12,150</b>



## RESULTS MEN'S RINGS FINAL

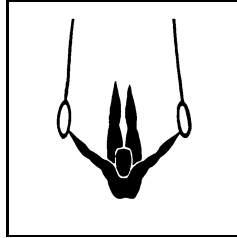

Rank	Bib	Name	NOC Code	D Score	E Score	Pen.	Total
1	059	COLAK Ibrahim	TUR	6.100	8,750		<b>14,850</b>
2	058	ASIL Adem	TUR	6.300	8,450		<b>14,750</b>
3	018	ZAHRAN Ali	EGY	6.100	8,500		<b>14,600</b>
4	042	LODADIO Marco	ITA	6.300	8,300		<b>14,600</b>
5	021	MOHAMED Omar	EGY	5.600	8,600		<b>14,200</b>
6	031	PHILIPPE Mathias	FRA	5.500	8,350		<b>13,850</b>
7	032	SALADINO Leo	FRA	5.100	8,600		<b>13,700</b>
8	034	ILIOPOULOS Nikolaos	GRE	4.700	8,000		<b>12,700</b>



## RESULTS MEN'S VAULT FINAL

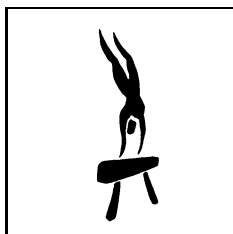

Rank	Bib	Name	NOC Code	D Score	E Score	Pen.	Total
1	058	ASIL Adem	TUR	5.600	9,500		<b>15,075</b>
				5.600	9,450		
2	039	BARTOLINI Nicola	ITA	5.200	9,400		<b>14,475</b>
				4.800	9,550		
3	041	LEVANTESI Matteo	ITA	5.200	9,050		<b>14,200</b>
				4.800	9,350		
4	048	ALMEIDA Filipe	POR	5.200	9,200		<b>13,825</b>
				4.000	9,250		
5	056	NAJJAR Lais	SYR	4.800	9,300		<b>13,775</b>
				4.400	9,050		
6	021	MOHAMED Omar	EGY	5.200	9,250	<b>-0.30</b>	<b>13,700</b>
				5.200	8,150	<b>-0.10</b>	
7	046	CAMPOS Guilherme	POR	4.800	9,300		<b>13,625</b>
				4.000	9,150		
8	061	ONDER Ahmet	TUR	5.200	8,150		<b>13,500</b>
				4.800	8,850		





## RESULTS MEN'S PARALLEL BARS FINAL

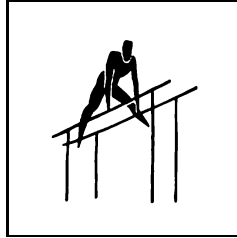

Rank	Bib	Name	NOC Code	D Score	E Score	Pen.	Total
1	057	ARICAN Ferhat	TUR	6.500	8,600		<b>15,100</b>
2	041	LEVANTESI Matteo	ITA	5.600	8,900		<b>14,500</b>
3	028	BERNARD Cameron-Lie	FRA	5.800	8,700		<b>14,500</b>
4	061	ONDER Ahmet	TUR	6.000	8,500		<b>14,500</b>
5	024	MIR Nicolau	ESP	5.500	8,900		<b>14,400</b>
6	014	GEORGIU Ilias	CYP	5.600	8,700		<b>14,300</b>
7	031	PHILIPPE Mathias	FRA	5.600	8,250		<b>13,850</b>
8	112	GIANNINI Lay	ITA	5.500	7,300		<b>12,800</b>



## RESULTS MEN'S HORIZONTAL BAR FINAL

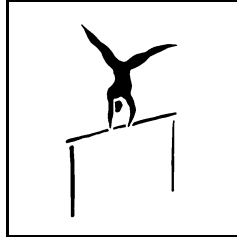

Rank	Bib	Name	NOC Code	D Score	E Score	Pen.	Total
1	013	GEORGIU Marios	CYP	5.800	8,500		<b>14,300</b>
2	058	ASIL Adem	TUR	5.400	8,550		<b>13,950</b>
3	061	ONDER Ahmet	TUR	5.900	7,750		<b>13,650</b>
4	031	PHILIPPE Mathias	FRA	5.600	8,000		<b>13,600</b>
5	041	LEVANTESI Matteo	ITA	5.100	8,350		<b>13,450</b>
6	019	ELMARAGHY Ahmed	EGY	4.900	7,800		<b>12,700</b>
7	034	ILIOPOULOS Nikolaos	GRE	4.600	7,300		<b>11,900</b>
8	024	MIR Nicolau	ESP	4.300	7,300		<b>11,600</b>



### Tie Break Report - men's qualifications



#### Floor

Rank	Bib	Name	NOC Code	Total	Execution Score	Difficulty Score
4	024	MIR Nicolau	ESP	14.100	8.80	
5	025	PLATA Joel	ESP	14.100	8.50	



#### Pommels Horse

Rank	Bib	Name	NOC Code	Total	Execution Score	Difficulty Score
4	039	BARTOLINI Nicola	ITA	13.950	8.45	
5	023	DIALLO Thierno	ESP	13.950	8.15	



### Tie Break Report - men's qualifications



#### Parallel Bars

Rank	Bib	Name	NOC Code	Total	Execution Score	Difficulty Score
2	041	LEVANTESI Matteo	ITA	14.500	8.90	
3	028	BERNARD Cameron-Lie	FRA	14.500	8.70	
4	061	ONDER Ahmet	TUR	14.500	8.50	



ألعاب البحر الأبيض المتوسط  
MEDITERRANEAN GAMES  
JEUX MÉDITERRANÉENS  
du 25 juin au 06 juillet

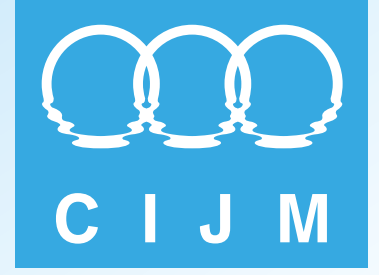

# Results Book



## Handball



**TOSYALI  
ALGERIE**

Fer et Acier

سوناطراي



sonarach



microplus  
DATA PROCESSING & TIMING  
[www.microplustiming.com](http://www.microplustiming.com)



## Medallists by event

As of WED 6 JUL 2022 at 18:09

Event	Date	Medal	Name	CTRY Code
Women	WED 6 JUL 2022	Gold	<b>SPAIN</b> CAMPOS COSTA Carmen ARROJERIA Esther HERNANDEZ SELVA Laura SPUGNINI SANTOME Alba Chiara GOMES DA COSTA Maria VEGUE I PENA Ona CUADRADO SANCHEZ Elena GASSAMA CISSOKHO Kaba LOIDI ETXANIZ June WIGGINS SANCHO Nicole AALLA ROTAEICHE Maddi VALERO JODAR Sara MBENGUE RODRIGUEZ Seynabou VALDIVIA MONSERRAT Paula Maria GASCO ARRANZ Clara ALVAREZ TORRADO Elba	ESP
		Silver	<b>CROATIA</b> BESEN Lucija SENVALD Sara POSAVEC Stela JAPUNDZA Tena PAVLOVIC Katarina SIMARA Andrea MALEC Ana BARISIC Tina PETIKA Tena TUCAKOVIC Antonija JARAK Lana VOJNOVIC Nika GUSKIC Ema BEBEK Josipa TUPEK Mia	CRO



## Medallists by event

As of WED 6 JUL 2022 at 18:09

Event	Date	Medal	Name	CTRY Code
Women	WED 6 JUL 2022	Bronze	<b>SERBIA</b> SIMIC Marija RADEVIC Dunja MIJAILOVIC Lana CETKOVIC Natasa OBRENOVIC Una VUKAJLOVIC Aleksandra INDIC Helena SUKUR Srna BOGUNOVIC Isidora DURASINOVIC Jelena JOVANOVIC Marija NUKOVIC Edita VELICKOVIC Teodora JOVOVIC Jovana TABAK Dunja BOJICIC Katarina	SRB



## Medallists by event

As of WED 6 JUL 2022 at 18:09

Event	Date	Medal	Name	CTRY Code
Men	WED 6 JUL 2022	Gold	<b>SPAIN</b> RODRIGUEZ LARIO Roberto GARCIANDIA ALUSTIZA Imanol BAZAN LEGASA Antonio VALERA ROVIRA Pol TARRAFETA SERRANO Ian MARTINEZ LOBATO Miguel IZQUIERDO LABAYEN Ander MARQUEZ COLOMA Jose Maria HERNANDEZ FERRER Sergey ODRIEZOLA YEREGUI Kauldi FOLQUES ORTIZ Josep SERRANO VILLALOBOS Jorge FERNANDEZ JIMENEZ Daniel GALLEGO MURO Jaime NIETO MARCOS Asier MARTIN BOTET Alberto	ESP
		Silver	<b>EGYPT</b> ABDU Abdelrahman NASRALLA Ahmed ABOUSALEM Mohamed ELMASRY Ibrahim ELWAKIL Omar ELDERAA Yehia KADDAH Hassan ELDERAA Seif ABDELHAK Mohab SAAD Akram ELAHMAR Ahmed MESILHY Ahmed HENDAWY Karim MOHAMED Ali SANAD Mohammed ELTAYAR Mohamed	EGY





## Medallists by event

As of WED 6 JUL 2022 at 18:09

Event	Date	Medal	Name	CTRY Code
Men	WED 6 JUL 2022	Bronze	<b>SERBIA</b> BOMASTAR Milan VORKAPIC Vukasin MILIC Milan BORZAS Uros JANDRIC Todor TRNAVAC Andrej KOJADINOVIC Uros PAVLOVIC Uros GOLUBOVIC Milan POPOVIC Veljko VIGNJEVIC Marko SOTIC Mladen PETRIC Stefan POPOVIC Ivan MILOSAVLJEVIC Marko GROZDANIC Milos	SRB



## Medallists

As of WED 6 JUL 2022 at 18:08

Gold	Silver	Bronze
<b>ESP - Spain</b>	<b>EGY - Egypt</b>	<b>SRB - Serbia</b>
16 RODRIGUEZ LARIO Roberto	10 ABDOL Abdelrahman	1 BOMASTAR Milan
18 GARCIANDIA ALUSTIZA Imanol	17 NASRALLA Ahmed	3 VORKAPIC Vukasin
23 BAZAN LEGASA Antonio	21 ABOUSALEM Mohamed	5 MILIC Milan
31 VALERA ROVIRA Pol	24 ELMASRY Ibrahim	6 BORZAS Uros
36 TARRAFETA SERRANO Ian	31 ELWAKIL Omar	12 JANDRIC Todor
49 MARTINEZ LOBATO Miguel	39 ELDERAA Yehia	16 TRNAVAC Andrej
55 IZQUIERDO LABAYEN Ander	42 KADDAH Hassan	17 KOJADINOVIC Uros
58 MARQUEZ COLOMA Jose Maria	45 ELDERAA Seif	18 PAVLOVIC Uros
61 HERNANDEZ FERRER Sergey	48 ABDELHAK Mohab	20 GOLUBOVIC Milan
62 ODRIEZOLA YEREGUI Kauldi	53 SAAD Akram	23 POPOVIC Veljko
63 FOLQUES ORTIZ Josep	66 ELAHMAR Ahmed	24 VIGNJEVIC Marko
64 SERRANO VILLALOBOS Jorge	80 MESILHY Ahmed	28 SOTIC Mladen
70 FERNANDEZ JIMENEZ Daniel	88 HENDAWY Karim	33 PETRIC Stefan
72 GALLEGO MURO Jaime	90 MOHAMED Ali	34 POPOVIC Ivan
73 NIETO MARCOS Asier	91 SANAD Mohammd	39 MILOSAVLJEVIC Marko
74 MARTIN BOTET Alberto	96 ELTAYAR Mohamed	69 GROZDANIC Milos



## Team Roster

As of MON 27 JUN 2022 at 21:18

### ALG - Algeria

No.	Name	Pos	L/R	Height m/ ft in	Weight kg / lbs	Date of Birt	Age	Club	Int. Matche Played	Int. G. Score
2	NAIM Zohir			1.75 / 5'	75 / 165	3 MAY 1996	26			
3	CHEHBOUR Nabil			1.75 / 5'	75 / 165	11 OCT 199	25			
4	HELLAL Nour-eddine			1.75 / 5'	75 / 165	23 MAY 199	26			
6	BERKOUS Messaoud			1.75 / 5'	75 / 165	20 JUN 1987	35			
10	REMILI Hamza			1.80 / 5'	70 / 154	12 MAR 198	35			
15	SAKER Redouane			1.85 / 6'	80 / 176	1 OCT 1991	30			
16	ZEMOUCHI Yahia A	GK		1.80 / 5'	70 / 154	17 SEP 1994	27			
17	DJEDID Yacine			1.75 / 5'	75 / 165	6 APR 1997	25			
18	KAABECHE Hichem			1.75 / 5'	75 / 165	12 MAR 199	32			
22	GHEDBANE Khalifa	GK		1.75 / 5'	75 / 165	26 NOV 199	25			
26	KOURI Mokhtar			1.75 / 5'	75 / 165	29 FEB 1996	26			
36	RAHIM Abdelkader			1.85 / 6'	80 / 176	12 JUL 1990	31			
44	HADJ SADOK Moustafa			1.75 / 5'	75 / 165	17 AUG 199	24			
77	ARIB Reda			1.75 / 5'	70 / 154	22 OCT 199	30			
87	ABDI Ayyoub			1.75 / 5'	75 / 165	16 FEB 1997	25			
94	KHERMOUCHE Bastien Jean R			1.85 / 6'	80 / 176	10 NOV 199	28			
				<b>Team averages</b>	1.78 / 5'	75.0 / 16				28.1

Coach	DJERANA Ahmed
Coach	GHERBI Rabah
Coach	TCHAKRABI Redouane
Doctor	REGGAD Djamel
Physiotherapist	MOUDJEBOUR Walid
Team Official	FAHIM Atallah
Team Official	SAIDOUNE Nabil

#### LEGEND

<b>B</b> Both Handed	<b>B</b> Back	<b>CB</b> Centre Back	<b>FP</b> Joueur
<b>GK</b> Goalkeeper	<b>Int.</b> International	<b>L</b> Left Handed	<b>LB</b> Left Back
<b>LW</b> Left Wing	<b>No.</b> Uniform Number	<b>P</b> Pivot	<b>Pos</b> Position
<b>R</b> Right Handed	<b>RB</b> Right Back	<b>RW</b> Right Wing	<b>W</b> Wing



## Team Roster

As of MON 27 JUN 2022 at 21:18

### EGY - Egypt

No.	Name	Pos	L/R	Height m/ ft in	Weight kg / lbs	Date of Birt	Age	Club	Int. Matche Played	Int. G. Score
10	ABDOU Abdelrahman					30 JAN 1996	26			
17	NASRALLA Ahmed			1.85 / 6'	80 / 176	15 SEP 1994	27			
21	ABOUSALEM Mohamed			2.02 / 6'	100 / 22	15 JAN 2002	20			
24	ELMASRY Ibrahim			1.90 / 6'	90 / 198	11 MAR 198	33			
31	ELWAKIL Omar			1.80 / 5'	80 / 176	14 MAY 198	34			
39	ELDERAA Yehia			1.89 / 6'	85 / 187	17 JUL 1995	26			
42	KADDAH Hassan			1.90 / 6'	85 / 187	1 MAY 2000	22			
45	ELDERAA Seif			1.80 / 5'	80 / 176	19 SEP 1998	23			
48	ABDELHAK Mohab			1.91 / 6'	87 / 192	20 JAN 2003	19			
53	SAAD Akram			1.90 / 6'	90 / 198	22 NOV 199	27			
66	ELAHMAR Ahmed			1.90 / 6'	90 / 198	27 JAN 1984	38			
80	MESILHY Ahmed			1.85 / 6'	80 / 176	25 NOV 199	27			
88	HENDAWY Karim	GK		1.90 / 6'	90 / 198	1 MAY 1988	34			
90	MOHAMED Ali			1.95 / 6'	90 / 198	14 DEC 199	31			
91	SANAD Mohammd			1.85 / 6'	89 / 196	16 JAN 1991	31			
96	ELTAYAR Mohamed	GK		1.85 / 6'	80 / 176	7 APR 1996	26			
<b>Team averages</b>				1.88 / 6'	86.4 / 19		27.8			

**Coach** LOSERT Venio  
**Assistant Coach** GARABAYA ARENAS Ruben  
**Physiotherapist** MOSA Mohamed

#### LEGEND

<b>B</b> Both Handed	<b>B</b> Back	<b>CB</b> Centre Back	<b>FP</b> Joueur
<b>GK</b> Goalkeeper	<b>Int.</b> International	<b>L</b> Left Handed	<b>LB</b> Left Back
<b>LW</b> Left Wing	<b>No.</b> Uniform Number	<b>P</b> Pivot	<b>Pos</b> Position
<b>R</b> Right Handed	<b>RB</b> Right Back	<b>RW</b> Right Wing	<b>W</b> Wing



## Team Roster

As of MON 27 JUN 2022 at 21:18

### ESP - Spain

No.	Name	Pos	L/R	Height m/ ft in	Weight kg / lbs	Date of Birt	Age	Club	Int. Matche Played	Int. G. Score
16	RODRIGUEZ LARIO Roberto	GK	Right	1.86 / 6'	84 / 185	19 JUL 2000	21	BM BENIDORM, BENIDORM (ES)		
18	GARCIANDIA ALUSTIZA Imano	RB	Left	2.02 / 6'	105 / 23	30 APR 1995	27	PICK SZEGED, SZEGED (HUN)	20	
23	BAZAN LEGASA Antonio	P	Right	1.96 / 6'	101 / 22	19 MAY 199	26	SC.D.R. ANAITASUNA, PAMPLO	13	
31	VALERA ROVIRA Pol	CB	Right	1.87 / 6'	77 / 170	19 AUG 199	23	FRAIKIN GRANOLLERS, GRANO	4	
36	TARRAFETA SERRANO Ian	CB	Right	1.88 / 6'	90 / 198	4 JAN 1999	23	PAUC HANDBALL, AIX EN PROV	22	
49	MARTINEZ LOBATO Miguel	RB	Left	1.94 / 6'	93 / 205	31 DEC 199	22	RECOLETAS VALLADOLID, VAL	8	
55	IZQUIERDO LABAYEN Ander	LB	Right	1.91 / 6'	86 / 190	1 MAY 2000	22	HELVETIA ANAITASUNA, PAMP	15	
58	MARQUEZ COLOMA Jose Mari	LB	Right	1.87 / 6'	96 / 212	20 DEC 199	25	FRAIKIN GRANOLLERS, GRANO	14	
61	HERNANDEZ FERRER Sergey	GK	Left	1.98 / 6'	97 / 214	17 JUN 1995	27	SL BENFICA, LISBOA (POR)	33	
62	ODRIOZOLA YEREGUI Kauldi	RW	Left	1.83 / 6'	82 / 181	7 JAN 1997	25	BIDASOA IRUN, IRUN (ESP)	28	
63	FOLQUES ORTIZ Josep	LW	Left	1.96 / 6'	90 / 198	8 APR 1996	26	SPORTING C DE PORTUGAL, LI	3	
64	SERRANO VILLALOBOS Jorge	RW	Left	1.84 / 6'	81 / 179	30 JUN 1997	24	RECOLETAS VALLADOLID, VAL	2	
70	FERNANDEZ JIMENEZ Daniel	LW	Right	1.77 / 5'	74 / 163	28 MAR 200	21	CANGAS DE MORRAZO, PONTE	6	
72	GALLEGO MURO Jaime	P	Right	1.99 / 6'	122 / 26	10 DEC 200	20	BM TORRELAVEGA, TORRELAV	2	
73	NIETO MARCOS Asier	LB	Right	1.90 / 6'	94 / 207	21 NOV 199	24	BM HUESCA, HUESCA (ESP)		
74	MARTIN BOTET Alberto	P	Right	1.95 / 6'	105 / 23	15 DEC 200	20	CLUB BALONMANO CANGAS, C		
<b>Team averages</b>									10.6	

#### Uniform Color (Shirts -

1st	Red	Blue
2nd	White	White

Coach	ALVAREZ ARRUTI Imanol
Coach	MARTINEZ MARTINEZ Jorge
Coach	MONTES AGUERA Cesar Jesus
Coach	PRADES PONS Jose Ignacio
Coach	RIBERA ROMANS Jordi
Doctor	MUNOZ BENITO Juan Jose
Physiotherapist	LLORENTE RUIZ Francisco Daniel
Physiotherapist	NAVARRO RIBERA Maria
Team Official	TORRESCUSA ALARCON Ignacio

#### LEGEND

<b>B</b> Both Handed	<b>B</b> Back	<b>CB</b> Centre Back	<b>FP</b> Joueur
<b>GK</b> Goalkeeper	<b>Int.</b> International	<b>L</b> Left Handed	<b>LB</b> Left Back
<b>LW</b> Left Wing	<b>No.</b> Uniform Number	<b>P</b> Pivot	<b>Pos</b> Position
<b>R</b> Right Handed	<b>RB</b> Right Back	<b>RW</b> Right Wing	<b>W</b> Wing



## Team Roster

As of MON 27 JUN 2022 at 21:18

### GRE - Greece

No.	Name	Pos	L/R	Height m/ ft in	Weight kg / lbs	Date of Birt	Age	Club	Int. Matche Played	Int. G. Score		
2	STEFANITSIS Ioannis	RW	Left	1.70 / 5'	70 / 154	15 OCT 200	18	ASE DOUKA, Athens (GRE)	4			
3	SINA Armando	LW	Right	1.80 / 5'	69 / 152	13 FEB 2002	20	DRAMA 1986, Drama (GRE)	4			
5	STATHIS Michail Nektarios			2.02 / 6'	95 / 209	14 OCT 200	19					
6	PAGIATIS Eleftherios	P	Right	1.85 / 6'	100 / 22	13 JUN 2002	20	ASE DOUKA, Athens (GRE)	4			
7	PAPAGIANNIS Christos	LW	Right	1.82 / 6'	74 / 163	2 JUL 2002	19	FILIPPOS VERIAS, Veroia (GRE)	4			
8	TZORTZINIS Nikolaos	RW	Left	1.96 / 6'	86 / 190	25 FEB 2002	20	P.A.O.K, Thessaloniki (GRE)	8			
9	PAPAZOGLU Athanasios	RB	Left	1.91 / 6'	85 / 187	28 JAN 2002	20	P.A.O.K, Thessaloniki (GRE)	6			
11	DIKAIOULIAS Nikolaos Marios	P	Right	1.90 / 6'	95 / 209	2 AUG 2003	18	AEK, ATHENS (GRE)	2			
12	BAMPATZANIDIS Dimitrios	GK	Right	1.94 / 6'	88 / 194	27 MAR 200	20	AESX PYLAIA, Thessaloniki (GR)	4			
13	ALEXANDRIDIS Pantelis Leoni	CB	Right	1.87 / 6'	102 / 22	9 FEB 2002	20	AESX PYLAIA, THESSALONIKI (	4			
15	TOSKAS Achilleas	RB	Left	1.92 / 6'	95 / 209	1 OCT 2004	17	DRAMA 1986, DRAMA (GRE)	4			
17	ANASTASIOU Eleftherios	LB	Right	1.95 / 6'	90 / 198	5 AUG 2002	19	ASE DOUKA, Athens (GRE)	4			
18	PANAGIOTOU Dimitrios	CB	Right	1.82 / 6'	85 / 187	21 MAY 200	18	ASE DOUKA, Athens (GRE)	2			
19	KOTSIONIS Konstantinos	CB	Right	1.90 / 6'	85 / 187	26 OCT 200	19	AEK, Athens (GRE)	4			
21	GEROULANOS Andreas	CB	Right	1.90 / 6'	102 / 22	2 JAN 2002	20	ASE DOUKA, Athens (GRE)	4			
30	ASLIS Nikolaos	GK	Right	1.96 / 6'	117 / 25	2 DEC 2002	19	ASE DOUKA, Athens (GRE)	4			
<b>Team averages</b>									1.89 / 6'	89.9 / 19	19.1	4.1

#### Uniform Color (Shirts -

1st	White	Blue
2nd	Blue	Blue

Coach	GEORGIADIS Nikolaos
Coach	PILALIDIS Ioannis
Physiotherapist	ELAVANOGLU Savvas
Team Official	CHRYSAFIS Georgios

#### LEGEND

<b>B</b> Both Handed	<b>B</b> Back	<b>CB</b> Centre Back	<b>FP</b> Joueur
<b>GK</b> Goalkeeper	<b>Int.</b> International	<b>L</b> Left Handed	<b>LB</b> Left Back
<b>LW</b> Left Wing	<b>No.</b> Uniform Number	<b>P</b> Pivot	<b>Pos</b> Position
<b>R</b> Right Handed	<b>RB</b> Right Back	<b>RW</b> Right Wing	<b>W</b> Wing



## Team Roster

As of MON 27 JUN 2022 at 21:18

### ITA - Italy

No.	Name	Pos	L/R	Height m/ ft in	Weight kg / lbs	Date of Birt	Age	Club	Int. Matche Played	Int. G. Score
1	VOLAREVIC Mate	GK	Right			4 JUN 1992	30	BRESSANONE, BRESSANONE (	13	
2	MORETTI Alessio	LB	Right			18 JUL 1994	27	CONVERSANO, CONVERSANO	54	
5	DAPIRAN Gianluca					9 MAY 1994	28			
6	BULZAMINI Davide	LB	Right			3 FEB 1995	27	BALONMANO CUENCA, CUENC	53	
8	SAVINI Giacomo	CB	Right			19 MAY 199	24	NIZZA, NIZZA (FRA)	39	
10	MENGON Marco	LB	Right			3 JAN 2000	22	CESSON RENNES, CESSON (F	28	
11	D'ANTINO Nicolo'	RW	Left			22 JUN 1999	23	BALONMANO, NAVA DE LA AS	37	
12	COLLELUORI Andrea	GK	Right	1.83 / 6'	82 / 181	17 MAY 200	22	17, CHERBOURG (FRA)		
13	BRONZO Umberto	RW	Left	1.83 / 6'	82 / 181	29 DEC 200	21	SASSARI, SASSARI (ITA)	15	
14	ARCIERI Stefano	LW	Right			8 MAY 1998	24	BRESSANONE, BRESSANONE (	35	
15	MENGON Simone	CB	Right			3 JAN 2000	22	BILLERE, BILLERE (FRA)	15	
18	MARTINI Oliver	P	Right			10 SEP 2001	20	MERANO, MERANO (ITA)	18	
19	BORTOLI Thomas					20 FEB 2002	20			
22	OPPEDISANO Axel	P	Right			22 DEC 199	25	NIZZA, NIZZA (FRA)	12	
32	PARISINI Andrea Carlo	P	Right			18 NOV 199	27	ISTRES PROVENCE, ISTRES (F	78	
66	PRANTNER Max	RB	Left	1.83 / 6'	82 / 181	24 JUN 2000	22	MERANO, MERANO (ITA)	7	
<b>Team averages</b>									31.1	

#### Uniform Color (Shirts -

1st	Blue	Blue
2nd	White	Blue

Coach	TRILLINI Riccardo
Coach	PRANTNER Juergen
Coach	MALAVASI PIGNATTI Luigi
Doctor	MORELLI Federico
Physiotherapist	ABBAFATI Giorgio
Physiotherapist	NUCELLI Matteo

#### LEGEND

<b>B</b> Both Handed	<b>B</b> Back	<b>CB</b> Centre Back	<b>FP</b> Joueur
<b>GK</b> Goalkeeper	<b>Int.</b> International	<b>L</b> Left Handed	<b>LB</b> Left Back
<b>LW</b> Left Wing	<b>No.</b> Uniform Number	<b>P</b> Pivot	<b>Pos</b> Position
<b>R</b> Right Handed	<b>RB</b> Right Back	<b>RW</b> Right Wing	<b>W</b> Wing



## Team Roster

As of MON 27 JUN 2022 at 21:18

### MKD - North Macedonia

No.	Name	Pos	L/R	Height m/ ft in	Weight kg / lbs	Date of Birt	Age	Club	Int. Matche Played	Int. G. Score
8	DJONOV Ivan			1.91 / 6'	82 / 181	15 JUL 1997	24			
9	GJORGIEV Igor			1.88 / 6'	81 / 179	2 JUN 2000	22			
10	MITEV Marko			1.84 / 6'	75 / 165	23 FEB 2003	19			
19	KOSTESKI Nenad			1.89 / 6'	76 / 168	4 MAR 2001	21			
20	KIZIKJ Marko	GK		1.98 / 6'	100 / 22	22 JAN 2001	21			
21	PETKOVSKI Aleksandar			1.86 / 6'	76 / 168	24 MAY 200	18			
23	IVANOSKI Mihail			1.93 / 6'	91 / 201	2 OCT 2002	19			
31	MLADENOVIKJ Mihajlo			1.95 / 6'	96 / 212	21 SEP 2000	21			
34	JAGURINOSKI Tomislav			1.88 / 6'	81 / 179	19 AUG 199	23			
42	STOJKOVIKJ Marko			2.04 / 6'	93 / 205	27 JUN 2003	19			
55	ATANASIJEVIKJ Petar			1.92 / 6'	83 / 183	9 JUL 2003	18			
77	SERAFIMOV Martin			1.90 / 6'	86 / 190	3 MAR 2000	22			
88	SIMONOSKI Kristijan			1.87 / 6'	90 / 198	29 MAY 200	22			
89	ATANASIJEVIKJ Pavle			1.95 / 6'	85 / 187	9 JUL 2003	18			
92	PETROV Kostadin			1.90 / 6'	105 / 23	30 MAR 199	30			
98	GGOV Vasil	GK		1.90 / 6'	100 / 22	3 NOV 2000	21			
<b>Team averages</b>				1.91 / 6'	87.5 / 19		21.1			

Coach **CRVENKOSKA Biljana**  
 Coach **BASNARKOV Petar**  
 Coach **LAZAROV Kiril**  
 Physiotherapist **VASILEVSKI Nebojsa**

#### LEGEND

<b>B</b> Both Handed	<b>B</b> Back	<b>CB</b> Centre Back	<b>FP</b> Joueur
<b>GK</b> Goalkeeper	<b>Int.</b> International	<b>L</b> Left Handed	<b>LB</b> Left Back
<b>LW</b> Left Wing	<b>No.</b> Uniform Number	<b>P</b> Pivot	<b>Pos</b> Position
<b>R</b> Right Handed	<b>RB</b> Right Back	<b>RW</b> Right Wing	<b>W</b> Wing





## Team Roster

As of MON 27 JUN 2022 at 21:18

### SLO - Slovenia

No.	Name	Pos	L/R	Height m/ ft in	Weight kg / lbs	Date of Birt	Age	Club	Int. Matche Played	Int. G. Score
1	SKLEDAR Alen	GK		1.89 / 6'	85 / 187	19 MAY 200	21			
4	MILICEVIC Uros			1.99 / 6'	104 / 22	29 SEP 1999	22			
5	HORVAT Gasper			1.98 / 6'	93 / 205	10 APR 1998	24			
6	MAZEJ Tadej			1.90 / 6'	90 / 198	31 JUL 1998	23			
7	ZAGAR Matevz					12 JUN 1999	23			
8	ROZMAN Tim			1.90 / 6'	95 / 209	11 DEC 199	23			
9	TAJNIK Domen			1.84 / 6'	86 / 190	31 OCT 200	21			
10	COKAN Tim			1.91 / 6'	86 / 190	7 JUN 2001	21			
11	PIPP Urban			1.87 / 6'	90 / 198	28 MAR 200	22			
13	GRMSEK Timotej			1.93 / 6'	97 / 214	19 MAY 200	22			
14	SLATINEK JOVICIC Stas			1.89 / 6'	88 / 194	6 DEC 2000	21			
15	SIKOSEK PELKO Domen			2.03 / 6'	118 / 26	18 AUG 199	24			
16	DOBAJ Gasper	GK				13 NOV 199	23			
17	KLJUN Tadej			1.96 / 6'	86 / 190	18 APR 2001	21			
18	KOTAR Marko			1.84 / 6'	82 / 181	6 MAR 1999	23			
20	DROBEZ Jernej			1.95 / 6'	106 / 23	6 JAN 2000	22			
				<b>Team averages</b>	1.92 / 6'	93.3 / 20	22.3			

#### Uniform Color (Shirts -

1st	Blue	Blue
2nd	White	White

Coach	SKOF Gorazd
Coach	KAVTICNIK Vid
Assistant Coach	ZVIZEJ Luka
Assistant Coach	ZORMAN Uros
Physiotherapist	LOTRIC Jan
Physiotherapist	SLOBODNIK Rudi
Team Official	MOCNIK Aljaz

#### LEGEND

<b>B</b> Both Handed	<b>B</b> Back	<b>CB</b> Centre Back	<b>FP</b> Joueur
<b>GK</b> Goalkeeper	<b>Int.</b> International	<b>L</b> Left Handed	<b>LB</b> Left Back
<b>LW</b> Left Wing	<b>No.</b> Uniform Number	<b>P</b> Pivot	<b>Pos</b> Position
<b>R</b> Right Handed	<b>RB</b> Right Back	<b>RW</b> Right Wing	<b>W</b> Wing
-			



## Team Roster

As of MON 27 JUN 2022 at 21:18

### SRB - Serbia

No.	Name	Pos	L/R	Height m/ ft in	Weight kg / lbs	Date of Birt	Age	Club	Int. Matche Played	Int. G. Score
1	BOMASTAR Milan	GK	Right	1.87 / 6'	80 / 176	10 JUL 1999	22	Ademar Leone, Leon (ESP)		
3	VORKAPIC Vukasin	RW	Left	1.83 / 6'	78 / 172	1 OCT 1997	24	Ivry, Ivry (FRA)	24	
5	MILIC Milan	RB	Left	1.77 / 5'	70 / 154	14 MAY 199	24	Nantes, Nantes (FRA)	24	
6	BORZAS Uros	LB	Right	1.79 / 5'	70 / 154	28 JUL 1999	22	Phenix Toulouse, Toulouse (FRA)	8	
12	JANDRIC Todor	GK	Right	1.90 / 6'	75 / 165	2 JUN 1998	24	Creteil, Creteil (FRA)	3	
16	TRNAVAC Andrej							(SRB)		
17	KOJADINOVIC Uros	RW	Left	1.75 / 5'	68 / 150	26 SEP 2000	21	Partizan, Beograd (SRB)		
18	PAVLOVIC Uros	P	Right	1.88 / 6'	80 / 176	20 OCT 199	23	Dinamo, Pancevo (SRB)		
20	GOLUBOVIC Milan			1.83 / 6'	77 / 170	21 SEP 2000	21			
23	POPOVIC Veljko	CB	Right	1.79 / 5'	70 / 154	18 FEB 2000	22	Partizan, Beograd (SRB)		
24	VIGNJEVIC Marko	LB	Right	1.81 / 5'	77 / 170	13 APR 1998	24	GWD Minden, Minden (GER)		
28	SOTIC Mladen	RW	Right	1.87 / 6'	80 / 176	5 FEB 1995	27	Vojvodina, Novi Sad (SRB)	11	
33	PETRIC Stefan	LB	Right	1.75 / 5'	68 / 150	14 JAN 2001	21	Partizan, Beograd (SRB)	1	
34	POPOVIC Ivan	P	Right	1.80 / 5'	75 / 165	21 MAR 199	28	Nice, Nice (FRA)	4	
39	MILOSAVLJEVIC Marko	CB	Right	1.79 / 5'	70 / 154	13 SEP 1998	23	Ademar Leon, Leon (ESP)	7	
69	GROZDANIC Milos	LW	Right	1.84 / 6'	75 / 165	18 FEB 1995	27	Coburg, Coburg (GER)	4	
<b>Team averages</b>									9.6	

#### Uniform Color (Shirts -

1st	Red	Red
2nd	White	White

Assistant Coach	JOVANOVIC Branka
Assistant Coach	BREGAR Uros
Assistant Coach	MARKOV Dragan
Assistant Coach	NOVAKOVIC Jovan
Assistant Coach	PEJANOVIC Dimitrije
Assistant Coach	MILOSAVLJEVIC Zikica
Physiotherapist	RADULOVIC Vladimir

#### LEGEND

<b>B</b> Both Handed	<b>B</b> Back	<b>CB</b> Centre Back	<b>FP</b> Joueur
<b>GK</b> Goalkeeper	<b>Int.</b> International	<b>L</b> Left Handed	<b>LB</b> Left Back
<b>LW</b> Left Wing	<b>No.</b> Uniform Number	<b>P</b> Pivot	<b>Pos</b> Position
<b>R</b> Right Handed	<b>RB</b> Right Back	<b>RW</b> Right Wing	<b>W</b> Wing



## Team Roster

As of MON 27 JUN 2022 at 21:18

### TUN - Tunisia

No.	Name	Pos	L/R	Height m/ ft in	Weight kg / lbs	Date of Birt	Age	Club	Int. Matche Played	Int. G. Score
9	BANNOUR Amine			1.96 / 6'	102 / 22	21 FEB 1990	32			
10	ABDELLI Bilel			1.89 / 6'	89 / 196	4 AUG 1995	26			
13	BHAR Mohamed Ali			1.83 / 6'	85 / 187	17 SEP 1989	32			
21	BOUGHANMI Oussama			1.85 / 6'	87 / 192	5 FEB 1990	32			
22	MAAREF Yousef			1.95 / 6'	85 / 187	21 JUL 1996	25			
27	RZIG Issam			1.82 / 6'	77 / 170	14 SEP 1989	32			
28	BACHA Hazem			2.05 / 6'	95 / 209	8 DEC 2001	20			
45	MUSTAPHA Ala			1.88 / 6'	90 / 198	15 APR 1999	23			
55	TOUMI Ghassen			1.80 / 5'	82 / 181	14 JUN 1997	25			
57	MAOUA Nouredine			1.86 / 6'	99 / 218	5 SEP 1998	23			
61	BELKAIED Yassine			1.97 / 6'	96 / 212	19 OCT 200	21			
69	JABALLAH Jihed			2.04 / 6'	119 / 26	29 JUL 1989	32			
71	DARMOUL Mohamed Amine			1.83 / 6'	81 / 179	4 FEB 1998	24			
90	CHOUIREF Marouan			1.95 / 6'	109 / 24	27 MAY 199	32			
92	JAZIRI Oussama			1.91 / 6'	96 / 212	6 NOV 1992	29			
94	HARBAOUI Mehdi Sadri			1.96 / 6'	92 / 203	11 SEP 1996	25			
				<b>Team averages</b>	1.91 / 6'	92.8 / 20				27.1

Coach	SAIDI Sami
Coach	MESSAOUED Zouhaier
Coach	SANAA Mohamed Riadh
Coach	BEN AMOR Moez
Coach	GRANDI Lotfi
Physiotherapist	HAMMAMI Naim
Physiotherapist	FEZZANI EP ABASSI Rania

#### LEGEND

<b>B</b> Both Handed	<b>B</b> Back	<b>CB</b> Centre Back	<b>FP</b> Joueur
<b>GK</b> Goalkeeper	<b>Int.</b> International	<b>L</b> Left Handed	<b>LB</b> Left Back
<b>LW</b> Left Wing	<b>No.</b> Uniform Number	<b>P</b> Pivot	<b>Pos</b> Position
<b>R</b> Right Handed	<b>RB</b> Right Back	<b>RW</b> Right Wing	<b>W</b> Wing
-			



## Team Roster

As of MON 27 JUN 2022 at 21:18

### TUR - Turkiye

No.	Name	Pos	L/R	Height m/ ft in	Weight kg / lbs	Date of Birt	Age	Club	Int. Matche Played	Int. G. Score
8	TINKIR Durmus Ali					17 MAR 199	28	(TUR)		
9	ILANC Genco					30 APR 2001	21	(TUR)		
12	YATKIN Enis	GK				7 OCT 1991	30	(TUR)		
16	GOKTEPE Coskun	GK				4 AUG 1988	33	(TUR)		
17	BICER Gorkem					2 JAN 1999	23	(TUR)		
24	OZTURK Halil Ibrahim					13 MAR 199	26	(TUR)		
27	SIRIN Atakan					14 MAY 200	22	(TUR)		
30	BABACAN Ali Emre					26 MAY 200	21	(TUR)		
32	KELESOGLU Ilkan					4 JUL 1999	22	(TUR)		
33	ATES Yasar Erdem					22 MAY 200	22	(TUR)		
34	YAGMUROGLU Sevket					10 JAN 2001	21	(TUR)		
52	AYDIN Alper					19 MAY 199	24	(TUR)		
53	KANBEROGLU Samet					23 MAR 199	24	(TUR)		
61	PEHLIVAN Omur					8 DEC 1997	24	(TUR)		
70	DURMAZ Tolga					18 JAN 2000	22	(TUR)		
77	BILIM Gokay					1 JAN 2002	20	(TUR)		
<b>Team averages</b>								23.9		

Coach	HALAY Okan Hulusi
Coach	AYDINLI Aydin
Coach	BUCESCHI Costica
Coach	INCI Mehmet Serkan

#### LEGEND

<b>B</b> Both Handed	<b>B</b> Back	<b>CB</b> Centre Back	<b>FP</b> Joueur
<b>GK</b> Goalkeeper	<b>Int.</b> International	<b>L</b> Left Handed	<b>LB</b> Left Back
<b>LW</b> Left Wing	<b>No.</b> Uniform Number	<b>P</b> Pivot	<b>Pos</b> Position
<b>R</b> Right Handed	<b>RB</b> Right Back	<b>RW</b> Right Wing	<b>W</b> Wing
-			



## Brackets

As of WED 6 JUL 2022 at 18:13

### Semi-finals

### Finals

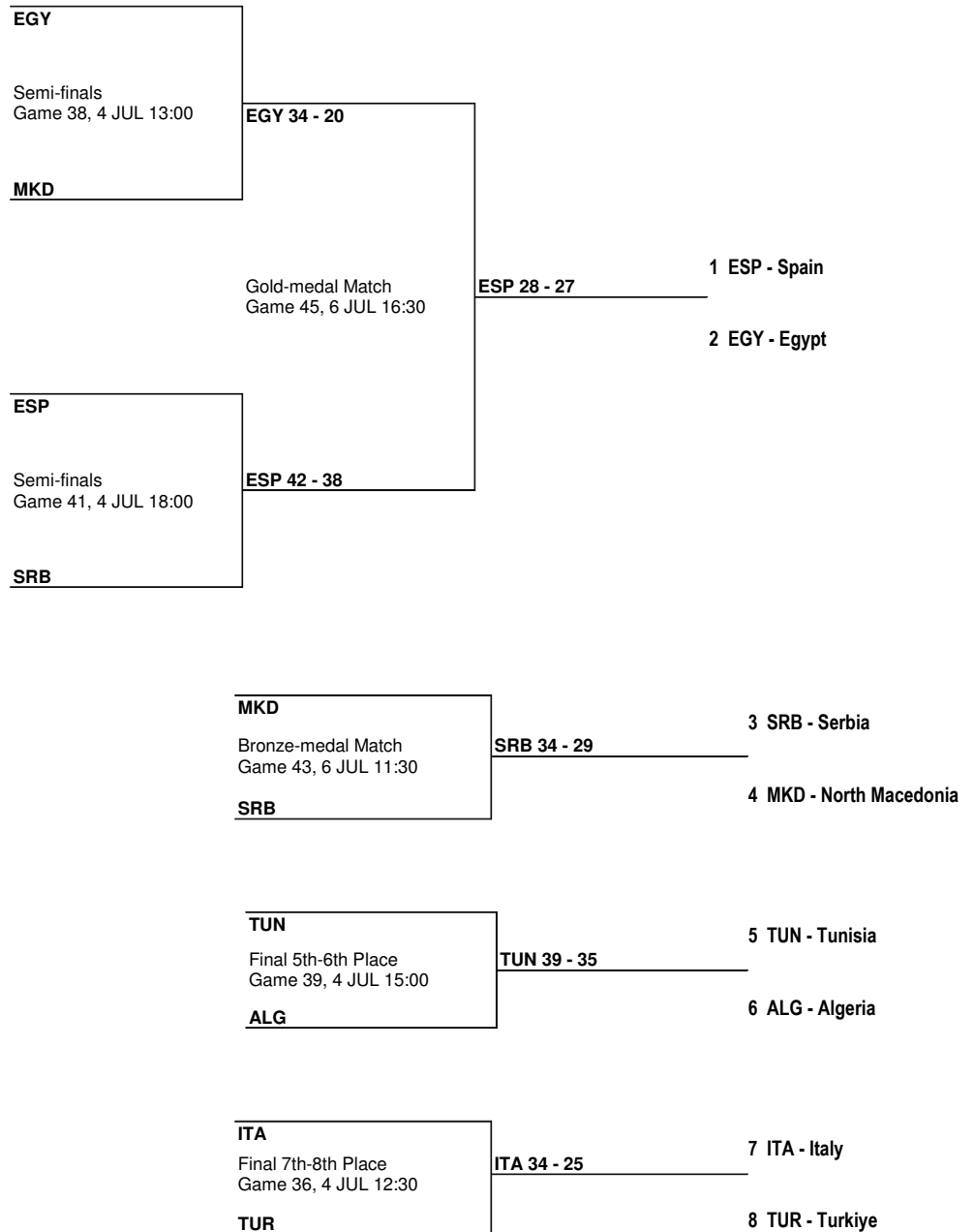



## Brackets

As of WED 6 JUL 2022 at 18:13

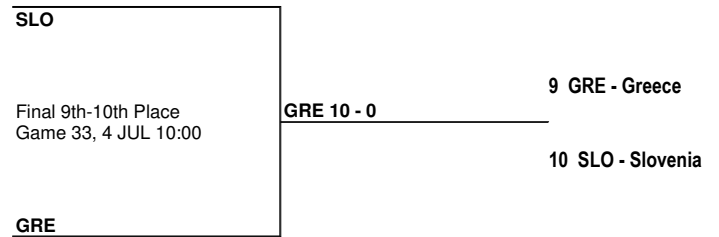



## Pool standings

As of SAT 2 JUL 2022 at 21:23

Group A							Matches				Goals			
Rank		EGY	SRB	TUN	ITA	SLO	Played	Won	Ties	Lost	For	Against	Diff.	Class. Point
1	<b>EGY</b>	---	35 - 28	30 - 26	38 - 35	10 - 0	4	4	0	0	113	89	24	8
2	<b>SRB</b>	28 - 35	---	35 - 29	34 - 33	10 - 0	4	3	0	1	107	97	10	6
3	<b>TUN</b>	26 - 30	29 - 35	---	34 - 29	10 - 0	4	2	0	2	99	94	5	4
4	<b>ITA</b>	35 - 38	33 - 34	29 - 34	---	10 - 0	4	1	0	3	107	106	1	2
5	<b>SLO</b>	0 - 10	0 - 10	0 - 10	0 - 10	---	4	0	0	4	0	40	-40	0

Group B							Matches				Goals			
Rank		ESP	MKD	ALG	TUR	GRE	Played	Won	Ties	Lost	For	Against	Diff.	Class. Point
1	<b>ESP</b>	---	31 - 22	31 - 19	46 - 19	46 - 21	4	4	0	0	154	81	73	8
2	<b>MKD</b>	22 - 31	---	24 - 24	31 - 22	39 - 21	4	2	1	1	116	98	18	5
3	<b>ALG</b>	19 - 31	24 - 24	---	32 - 27	35 - 25	4	2	1	1	110	107	3	5
4	<b>TUR</b>	19 - 46	22 - 31	27 - 32	---	28 - 26	4	1	0	3	96	135	-39	2
5	<b>GRE</b>	21 - 46	21 - 39	25 - 35	26 - 28	---	4	0	0	4	93	148	-55	0

## Match Results

Date	Start Time	Phase	Match	Teams	Result
MON 27 JUN	14:00	Preliminary Group A	1	SLO - SRB	0 - 10
MON 27 JUN	16:00	Preliminary Group A	2	EGY - ITA	38 - 35
MON 27 JUN	18:00	Preliminary Group B	3	TUR - ALG	27 - 32
MON 27 JUN	20:00	Preliminary Group B	4	MKD - GRE	39 - 21
TUE 28 JUN	14:00	Preliminary Group A	5	SRB - EGY	28 - 35
TUE 28 JUN	16:00	Preliminary Group A	6	TUN - SLO	10 - 0
TUE 28 JUN	18:00	Preliminary Group B	7	ALG - MKD	24 - 24
TUE 28 JUN	20:00	Preliminary Group B	8	ESP - TUR	46 - 19
THU 30 JUN	12:00	Preliminary Group A	9	EGY - TUN	30 - 26
THU 30 JUN	14:00	Preliminary Group A	11	ITA - SRB	33 - 34
THU 30 JUN	16:00	Preliminary Group B	13	MKD - ESP	22 - 31
THU 30 JUN	19:00	Preliminary Group B	15	GRE - ALG	25 - 35
FRI 1 JUL	12:00	Preliminary Group A	17	TUN - ITA	34 - 29
FRI 1 JUL	14:15	Preliminary Group A	19	SLO - EGY	0 - 10
FRI 1 JUL	17:00	Preliminary Group B	21	ESP - GRE	46 - 21
FRI 1 JUL	19:15	Preliminary Group B	23	TUR - MKD	22 - 31
SAT 2 JUL	12:00	Preliminary Group A	25	ITA - SLO	10 - 0
SAT 2 JUL	14:15	Preliminary Group A	27	SRB - TUN	35 - 29
SAT 2 JUL	17:00	Preliminary Group B	29	GRE - TUR	26 - 28
SAT 2 JUL	19:15	Preliminary Group B	31	ALG - ESP	19 - 31



MON 27 JUN 2022

## Results

Start Time 14:00

Game Duration: 00:40

### SLO 27 vs 31 SRB (15-15) (12-16)

Referees: Mustapha DECHE (ALG) Mohamed GUARDA (ALG)

#### SLO - Slovenia

Players		Shots								Punishment			
No.	Name	G / S	%	6m	Wing	9m	7m	FB	BT	YC	2Mi	RC	BC
1	SKLEDAR Alen												
4	MILICEVIC Uros	1/1	100					1/1					
5	HORVAT Gasper	2/2	100	1/1		1/1							
6	MAZEJ Tadej	0/2	0	0/1	0/1								
7	ZAGAR Matevz	1/1	100				1/1				1		
8	ROZMAN Tim	2/2	100	2/2									
9	TAJNIK Domen	2/2	100	2/2									
10	COKAN Tim	4/8	50	1/2	2/4		1/2						
11	PIPP Urban	6/6	100	2/2			4/4						
13	GRMSEK Timotej	1/3	33			0/2		1/1					
14	SLATINEK JOVICIC Stas	5/5	100		2/2			3/3					
15	SIKOSSEK PELKO Domen	1/1	100	1/1									
16	DOBAJ Gasper												
17	KLJUN Tadej	2/3	67	1/1		1/2				1	1		
18	KOTAR Marko												
20	DROBEZ Jernej												
<b>Bench/Team Totals</b>		27/36	75	10/12	4/7	2/5	6/7	5/5		1	2		

Goalkeepers		Saves							
No.	Name	S / S	%	6m	Win	9m	7m	FB	BT
1	SKLEDAR Alen	5/21	24	1/6	0/4	4/8	0/2	0/1	
16	DOBAJ Gasper	3/18	17	0/9	1/2	1/3	0/2	1/2	
<b>Totals</b>		8/39	21	1/15	1/6	5/11	0/4	1/3	

#### SRB - Serbia

Players		Shots								Punishment			
No.	Name	G / S	%	6m	Wing	9m	7m	FB	BT	YC	2Mi	RC	BC
1	BOMASTAR Milan												
3	VORKAPIC Vukasin	4/7	57		1/2	1/2		2/3			2		
5	MILIC Milan	7/7	100	4/4		3/3					1		
6	BORZAS Uros	2/3	67	1/2	1/1					1			
12	JANDRIC Todor												
17	KOJADINOVIC Uros										1		
18	PAVLOVIC Uros	1/1	100	1/1							1		
20	GOLUBOVIC Milan												
23	POPOVIC Veliko												
24	VIGNJEVIC Marko	0/1	0			0/1							
25	RATKOVIC Nemanja												
28	SOTIC Mladen	1/1	100	1/1									
33	PETRIC Stefan	1/2	50	1/1		0/1							
34	POPOVIC Ivan	2/3	67	2/2		0/1				1	3	1	
39	MILOSAVLJEVIC Marko	5/7	71	2/2		2/4	1/1				1		
69	GROZDANIC Milos	8/8	100	2/2	3/3		3/3						
<b>Bench/Team Totals</b>		31/40	78	14/15	5/6	6/12	4/4	2/3		2	9	1	

Goalkeepers		Saves							
No.	Name	S / S	%	6m	Win	9m	7m	FB	BT
1	BOMASTAR Milan	5/32	16	2/12	2/6	1/3	0/6	0/5	
12	JANDRIC Todor								
17	KOJADINOVIC Uros								
<b>Totals</b>		5/32	16	2/12	2/6	1/3	0/6	0/5	





MON 27 JUN 2022

Start Time 14:00

Game Duration: 00:40

## Results

### RUNNING SCORE

#### SLO - SRB

1st Half		2nd Half	
KLJUN T.	1 (2') 0	15 (35') 16	GROZDANIC M.
HORVAT G.	2 (3') 0	PIPP U.	16 (37') 16
	2 (4') 1	POPOVIC I.	16 (37') 17
	2 (6') 2	MILOSAVLJEVIC	ROZMAN T.
	2 (6') 3	MILIC M.	17 (38') 17
KLJUN T.	3 (7') 3		17 (38') 18
	3 (7') 4	VORKAPIC V.	17 (38') 19
TAJNIK D.	4 (8') 4		18 (39') 19
	4 (9') 5	GROZDANIC M.	18 (40') 20
	4 (11') 6	MILIC M.	PIPP U.
COKAN T.	5 (12') 6		19 (40') 20
	5 (13') 7	BORZAS U.	19 (41') 21
COKAN T.	6 (13') 7		PIPP U.
	6 (14') 8	BORZAS U.	20 (42') 21
	6 (15') 9	MILIC M.	20 (43') 22
	6 (17') 10	MILOSAVLJEVIC	ROZMAN T.
	6 (19') 11	VORKAPIC V.	21 (44') 22
SLATINEK S.	7 (19') 11		21 (45') 23
	7 (20') 12	PAVLOVIC U.	21 (46') 24
	8 (21') 12		PIPP U.
COKAN T.	8 (21') 12		22 (46') 24
SIKOSEK D.	9 (23') 12		22 (48') 25
GRMSEK T.	10 (23') 12		23 (49') 25
SLATINEK S.	11 (25') 12		23 (50') 26
	11 (25') 13	GROZDANIC M.	COKAN T.
SLATINEK S.	12 (26') 13		24 (53') 26
	12 (27') 14	VORKAPIC V.	24 (53') 27
	12 (28') 15	GROZDANIC M.	24 (53') 28
PIPP U.	13 (28') 15		SLATINEK S.
PIPP U.	14 (29') 15		25 (55') 28
MILICEVIC U.	15 (30') 15		25 (55') 29
			25 (56') 30
			ZAGAR M.
			26 (59') 30
			SLATINEK S.
			27 (59') 30
			27 (60') 31
			MILOSAVLJEVIC

### LEGEND

%	Efficiency	(C)	Captain	2Min	2 minutes suspension	6m	6 metre Shots
7m	7 metre Shots	7mS	7metre Saves	9m	9 metre Shots	BC	Blue Cards
BT	Break Through Shots	FB	Fast Break Shots	G / S	Goals/Shots	No.	Uniform Number
RC	Red Cards	S	Saves	Wing	Wing Shots	YC	Yellow Card



MON 27 JUN 2022

Results

Start Time 16:00

Game Duration: 01:26

EGY 38 vs 35 ITA  
(20-14) (18-21)

Referees: Mihajlo ILIEVSKI (MKD) Metodija ILIEVSKI (MKD)

EGY - Egypt

Players			Shots							Punishment			
No.	Name	G / S	%	6m	Wing	9m	7m	FB	BT	YC	2Mi	RC	BC
10	ABDOU Abdelrahman	0/1	0			0/1							
17	NASRALLA Ahmed												
21	ABOUSALEM Mohamed	1/1	100			1/1							
24	ELMASRY Ibrahim												
31	ELWAKIL Omar	2/2	100	2/2									
39	ELDERAA Yehia	3/3	100	2/2		1/1							
42	KADDAH Hassan	9/11	82	8/9		1/2					1		
45	ELDERAA Seif										1		
48	ABDELHAK Mohab	4/5	80	1/2		3/3					1		
53	SAAD Akram	2/3	67	1/1	1/1		0/1						
66	ELAHMAR Ahmed	6/6	100	3/3	1/1		2/2						
80	MESILHY Ahmed	7/10	70	6/7		1/3							
88	HENDAWY Karim												
91	SANAD Mohammad	4/5	80	1/1	2/3			1/1					
96	ELTAYAR Mohamed												
<b>Bench/Team</b>													
<b>Totals</b>		38/47	81	24/27	4/5	7/11	2/3	1/1			3		

Goalkeepers		Saves							
No.	Name	S / S	%	6m	Win	9m	7m	FB	BT
88	HENDAWY Karim	7/22	32	3/11	0/1	4/7	0/1	0/2	
96	ELTAYAR Mohamed	2/22	9	2/11	0/5	0/2	0/2	0/2	
<b>Totals</b>		9/44	20	5/22	0/6	4/9	0/3	0/4	

ITA - Italy

Players			Shots							Punishment			
No.	Name	G / S	%	6m	Wing	9m	7m	FB	BT	YC	2Mi	RC	BC
1	VOLAREVIC Mate												
2	MORETTI Alessio	3/5	60			2/4	1/1						
5	DAPIRAN Gianluca	4/5	80	1/2	2/2			1/1					
6	BULZAMINI Davide	1/4	25	0/1		1/3							
8	SAVINI Giacomo	3/3	100	2/2		1/1							
10	MENGON Marco	2/3	67	2/3						1			
11	D'ANTINO Nicolo'	5/5	100	1/1	3/3			1/1					
12	COLLELUORI Andrea												
13	BRONZO Umberto												
14	ARCIERI Stefano	1/1	100	1/1									
15	MENGON Simone	4/4	100		1/1	1/1		2/2					
18	MARTINI Oliver	1/1	100	1/1									
19	BORTOLI Thomas												
22	OPPEDISANO Axel	3/3	100	1/1			2/2						
32	PARISINI Andrea Carlo	8/9	89	8/9									
66	PRANTNER Max	0/2	0	0/1		0/1							
<b>Bench/Team</b>													
<b>Totals</b>		35/45	78	17/22	6/6	5/10	3/3	4/4			1		

Goalkeepers		Saves							
No.	Name	S / S	%	6m	Win	9m	7m	FB	BT
1	VOLAREVIC Mate	3/23	13	1/12	0/2	1/7	1/2		
12	COLLELUORI Andrea	4/22	18	1/14	0/2	3/4	0/1	0/1	
<b>Totals</b>		7/45	16	2/26	0/4	4/11	1/3	0/1	



MON 27 JUN 2022

Start Time 16:00

Game Duration: 01:26

## Results

### RUNNING SCORE

#### EGY - ITA

1st Half		2nd Half	
SAAD A.	1 (2') 0	MESILHY A.	21 (32') 14
KADDAH H.	2 (2') 0		21 (32') 15 DAPIRAN G.
	2 (2') 1 PARISINI A.	KADDAH H.	22 (33') 15
KADDAH H.	3 (3') 1		22 (33') 16 SAVINI G.
	3 (3') 2 ARCIERI S.	KADDAH H.	23 (34') 16
KADDAH H.	4 (4') 2		23 (36') 17 PARISINI A.
	4 (4') 3 MENGON M.	MESILHY A.	24 (37') 17
	4 (5') 4 D'ANTINO N.		24 (37') 18 MENGON S.
SAAD A.	5 (5') 4		24 (39') 19 PARISINI A.
MESILHY A.	6 (9') 4		24 (40') 20 D'ANTINO N.
	6 (9') 5 BULZAMINI D.		24 (41') 21 PARISINI A.
ELAHMAR A.	7 (10') 5		24 (42') 22 MENGON M.
ELAHMAR A.	8 (12') 5	MESILHY A.	25 (43') 22
KADDAH H.	9 (12') 5	ELAHMAR A.	26 (45') 22
	9 (12') 6 PARISINI A.		26 (45') 23 DAPIRAN G.
ELAHMAR A.	10 (13') 6	ELDERAA Y.	27 (45') 23
ELDERAA Y.	11 (14') 6		27 (46') 24 DAPIRAN G.
	11 (14') 7 PARISINI A.	SANAD M.	28 (46') 24
MESILHY A.	12 (15') 7		28 (47') 25 MORETTI A.
	12 (15') 8 MENGON S.		28 (48') 26 OPPEDISANO A.
ELDERAA Y.	13 (16') 8	ELWAKIL O.	29 (49') 26
	13 (17') 9 D'ANTINO N.		29 (49') 27 SAVINI G.
ABDELHAK M.	14 (18') 9	KADDAH H.	30 (49') 27
	14 (18') 10 MARTINI O.		30 (50') 28 PARISINI A.
MESILHY A.	15 (19') 10		30 (50') 29 MENGON S.
MESILHY A.	16 (20') 10	SANAD M.	31 (51') 29
ABDELHAK M.	17 (23') 10	KADDAH H.	32 (53') 29
	17 (23') 11 MORETTI A.	ELAHMAR A.	33 (54') 29
ABOUSALEM M.	18 (24') 11		33 (55') 30 MENGON S.
	18 (25') 12 DAPIRAN G.	SANAD M.	34 (56') 30
	18 (26') 13 PARISINI A.		34 (57') 31 OPPEDISANO A.
ABDELHAK M.	19 (26') 13	ELWAKIL O.	35 (57') 31
ABDELHAK M.	20 (28') 13		35 (58') 32 MORETTI A.
	20 (30') 14 OPPEDISANO A.	SANAD M.	36 (58') 32
			36 (59') 33 D'ANTINO N.
		KADDAH H.	37 (59') 33
			37 (60') 34 SAVINI G.
		ELAHMAR A.	38 (60') 34
			38 (60') 35 D'ANTINO N.

#### LEGEND

%	Efficiency	(C)	Captain	2Min	2 minutes suspension	6m	6 metre Shots
7m	7 metre Shots	7mS	7metre Saves	9m	9 metre Shots	BC	Blue Cards
BT	Break Through Shots	FB	Fast Break Shots	G / S	Goals/Shots	No.	Uniform Number
RC	Red Cards	S	Saves	Wing	Wing Shots	YC	Yellow Card



TUE 28 JUN 2022

Results

Start Time 14:00

Game Duration: 01:29

SRB 28 vs 35 EGY  
(12-16) (16-19)

Referees: Marta SA (POR) Vania SA (POR)

SRB - Serbia

Players		Shots								Punishment			
No.	Name	G / S	%	6m	Wing	9m	7m	FB	BT	YC	2Mi	RC	BC
1	BOMASTAR Milan												
3	VORKAPIC Vukasin	4/5	80		2/3			2/2			1		
5	MILIC Milan	3/6	50	1/1		2/5					2		
6	BORZAS Uros	2/5	40	1/3		1/2				1			
12	JANDRIC Todor												
16	TRNAVAC Andrej												
17	KOJADINOVIC Uros	1/3	33	1/1	0/1	0/1					1		
18	PAVLOVIC Uros	1/1	100	1/1									
20	GOLUBOVIC Milan	1/1	100			1/1							
23	POPOVIC Veliko	1/2	50	0/1				1/1			1		
24	VIGNJEVIC Marko												
28	SOTIC Mladen	2/4	50	1/1	1/1	0/2							
33	PETRIC Stefan	2/3	67	1/1		1/2							
34	POPOVIC Ivan	3/4	75	3/4						1			
39	MILOSAVLJEVIC Marko	1/6	17	0/3		1/2		0/1					
69	GROZDANIC Milos	7/8	88	1/1	3/4		2/2	1/1			1		
<b>Bench/Team Totals</b>		28/48	58	10/17	6/9	6/15	2/2	4/5		2	6		

Goalkeepers		Saves							
No.	Name	S / S	%	6m	Win	9m	7m	FB	BT
1	BOMASTAR Milan								
12	JANDRIC Todor	13/48	27	5/16	0/4	5/16	1/6	2/6	
<b>Totals</b>		13/48	27	5/16	0/4	5/16	1/6	2/6	

EGY - Egypt

Players		Shots								Punishment			
No.	Name	G / S	%	6m	Wing	9m	7m	FB	BT	YC	2Mi	RC	BC
10	ABDOU Abdelrahman												
17	NASRALLA Ahmed	0/1	0	0/1									
21	ABOUSALEM Mohamed	2/2	100	2/2									
24	ELMASRY Ibrahim										1		
31	ELWAKIL Omar	4/7	57	2/4	1/1			1/2					
39	ELDERAA Yehia	4/6	67	1/3		3/3							
42	KADDAH Hassan	3/5	60	0/1		3/4							
45	ELDERAA Seif	3/7	43	1/2		2/5							
48	ABDELHAK Mohab	3/5	60	1/1		2/4					1		
53	SAAD Akram	2/3	67		1/1		0/1	1/1					
66	ELAHMAR Ahmed	6/7	86		1/1	1/2	4/4						
80	MESILHY Ahmed	4/8	50	4/8							1		
88	HENDAWY Karim												
90	MOHAMED Ali												
91	SANAD Mohammd	4/6	67		1/1		1/2	2/3					
96	ELTAYAR Mohamed												1
<b>Bench/Team Totals</b>		35/57	61	11/22	4/4	11/18	5/7	4/6			3		1

Goalkeepers		Saves							
No.	Name	S / S	%	6m	Win	9m	7m	FB	BT
88	HENDAWY Karim	7/23	30	4/9	0/2	3/7	0/2	0/3	
96	ELTAYAR Mohamed	6/18	33	2/7	0/4	3/5		1/2	
<b>Totals</b>		13/41	32	6/16	0/6	6/12	0/2	1/5	



TUE 28 JUN 2022

Start Time 14:00

Game Duration: 01:29

## Results

### RUNNING SCORE

#### SRB - EGY

1st Half	2nd Half
<b>0 (2') 1</b> ELAHMAR A.	<b>12 (31') 17</b> KADDAH H.
VORKAPIC V. <b>1 (2') 1</b>	<b>12 (33') 18</b> MESILHY A.
VORKAPIC V. <b>2 (3') 1</b>	GROZDANIC M. <b>13 (33') 18</b>
VORKAPIC V. <b>3 (4') 1</b>	POPOVIC I. <b>14 (35') 18</b>
<b>3 (6') 2</b> ABOUSALEM M.	GOLUBOVIC M. <b>15 (35') 18</b>
BORZAS U. <b>4 (8') 2</b>	<b>15 (36') 19</b> ABDELHAK M.
<b>4 (9') 3</b> ELAHMAR A.	<b>15 (37') 20</b> KADDAH H.
<b>4 (10') 4</b> ABDELHAK M.	<b>15 (37') 21</b> ABDELHAK M.
POPOVIC I. <b>5 (11') 4</b>	POPOVIC I. <b>16 (38') 21</b>
BORZAS U. <b>6 (13') 4</b>	<b>16 (38') 22</b> KADDAH H.
<b>6 (13') 5</b> ELDERAA S.	GROZDANIC M. <b>17 (39') 22</b>
SOTIC M. <b>7 (13') 5</b>	VORKAPIC V. <b>18 (40') 22</b>
<b>7 (13') 6</b> ELWAKIL O.	<b>18 (40') 23</b> ELDERAA Y.
MILOSAVLJEVIC <b>8 (14') 6</b>	<b>18 (41') 24</b> SAAD A.
<b>8 (14') 7</b> ABOUSALEM M.	MILIC M. <b>19 (41') 24</b>
MILIC M. <b>9 (16') 7</b>	MILIC M. <b>20 (42') 24</b>
<b>9 (19') 8</b> SANAD M.	<b>20 (43') 25</b> ELAHMAR A.
<b>9 (19') 9</b> ELWAKIL O.	PETRIC S. <b>21 (44') 25</b>
GROZDANIC M. <b>10 (21') 9</b>	<b>21 (44') 26</b> ELDERAA Y.
<b>10 (22') 10</b> ELWAKIL O.	<b>21 (47') 27</b> ELDERAA S.
<b>10 (22') 11</b> SANAD M.	GROZDANIC M. <b>22 (48') 27</b>
<b>10 (25') 12</b> SANAD M.	PETRIC S. <b>23 (49') 27</b>
<b>10 (27') 13</b> MESILHY A.	<b>23 (50') 28</b> ELAHMAR A.
PAVLOVIC U. <b>11 (27') 13</b>	GROZDANIC M. <b>24 (51') 28</b>
SOTIC M. <b>12 (28') 13</b>	<b>24 (52') 29</b> SAAD A.
<b>12 (29') 14</b> MESILHY A.	GROZDANIC M. <b>25 (53') 29</b>
<b>12 (30') 15</b> SANAD M.	POPOVIC V. <b>26 (55') 29</b>
<b>12 (30') 16</b> MESILHY A.	<b>26 (56') 30</b> ELAHMAR A.
	<b>26 (57') 31</b> ELDERAA S.
	KOJADINOVIC U. <b>27 (57') 31</b>
	<b>27 (57') 32</b> ELDERAA Y.
	<b>27 (58') 33</b> ELDERAA Y.
	<b>27 (59') 34</b> ELWAKIL O.
	GROZDANIC M. <b>28 (59') 34</b>
	<b>28 (60') 35</b> ELAHMAR A.

### LEGEND

% Efficiency	(C) Captain	2Min 2 minutes suspension	6m 6 metre Shots
7m 7 metre Shots	7mS 7metre Saves	9m 9 metre Shots	BC Blue Cards
BT Break Through Shots	FB Fast Break Shots	G / S Goals/Shots	No. Uniform Number
RC Red Cards	S Saves	Wing Wing Shots	YC Yellow Card



TUE 28 JUN 2022

## Results

Start Time 16:00

Game Duration: 01:31

### TUN 36 vs 34 SLO

(22-12) (14-22)

Referees: Luis DIAZ FLORES GOMEZ (ESP) Enrique PEREZ GONZALEZ (ES)

#### TUN - Tunisia

Players		Shots								Punishment			
No.	Name	G / S	%	6m	Wing	9m	7m	FB	BT	YC	2Mi	RC	BC
9	BANNOUR Amine	2/5	40	1/2		1/3							
10	ABDELLI Bilel	1/1	100			1/1							
13	BHAR Mohamed Ali										1		
21	BOUGHANMI Oussama	5/6	83	0/1	2/2	1/1	2/2				1		
22	MAAREF Yousef	8/10	80	3/3		4/6		1/1					
27	RZIG Issam	4/5	80		0/1		2/2	2/2					
28	BACHA Hazem	4/5	80	3/3		1/2							
45	MUSTAPHA Ala												
55	TOUMI Ghassen	3/4	75	1/1	1/1	0/1		1/1					
57	MAOUA Nouredine	1/3	33	1/1		0/2					1		
61	BELKAIED Yassine												
69	JABALLAH Jihed	3/3	100	3/3									
71	DARMOUL Mohamed Amine	4/10	40	1/5		3/5							
90	CHOUREF Marouan	1/2	50	1/2							2		
92	JAZIRI Oussama												
94	HARBAOUI Mehdi Sadri												
<b>Bench/Team</b>													
<b>Totals</b>		36/54	67	14/21	3/4	11/21	4/4	4/4			5		

Goalkeepers		Saves							
No.	Name	S / S	%	6m	Win	9m	7m	FB	BT
61	BELKAIED Yassine	6/20	30	3/6	0/3	2/4	0/2	1/5	
94	HARBAOUI Mehdi Sadri	9/29	31	2/12	1/5	5/7	1/3	0/1	0/1
<b>Totals</b>		15/49	31	5/18	1/8	7/11	1/5	1/6	0/1

#### SLO - Slovenia

Players		Shots								Punishment			
No.	Name	G / S	%	6m	Wing	9m	7m	FB	BT	YC	2Mi	RC	BC
1	SKLEDAR Alen												
4	MILICEVIC Uros	2/3	67	1/1		1/2							
5	HORVAT Gasper	1/4	25	0/1	1/1	0/2					3		
6	MAZEJ Tadej	0/1	0		0/1						1		
7	ZAGAR Matevz	5/11	45	1/5		1/3	2/2	1/1					
8	ROZMAN Tim	0/2	0			0/2							
9	TAJNIK Domen	1/2	50	1/1	0/1								
10	COKAN Tim	5/6	83		3/3		0/1	2/2					
11	PIPP Urban	4/5	80	1/1			2/3	1/1			1		
13	GRMSEK Timotej	1/2	50	0/1		1/1							
14	SLATINEK JOVICIC Stas	7/10	70	2/4	3/4			1/1	1/1				
15	SIKOSSEK PELKO Domen	1/1	100	1/1									
16	DOBAJ Gasper												
17	KLJUN Tadej	2/5	40	2/2		0/2		0/1			1		
18	KOTAR Marko	3/3	100	3/3									
20	DROBEZ Jernej	2/2	100	1/1		1/1							
<b>Bench/Team</b>													
<b>Totals</b>		34/57	60	13/21	7/10	4/13	4/6	5/6	1/1		6		

Goalkeepers		Saves							
No.	Name	S / S	%	6m	Win	9m	7m	FB	BT
1	SKLEDAR Alen	10/44	23	6/20	0/3	4/15	0/3	0/3	
7	ZAGAR Matevz								
16	DOBAJ Gasper	0/1	0			0/1			
<b>Totals</b>		10/45	22	6/20	0/3	4/15	0/4	0/3	



TUE 28 JUN 2022

Start Time 16:00

Game Duration: 01:31

## Results

### RUNNING SCORE

#### TUN - SLO

1st Half	2nd Half
BACHA H. 1 (2') 0	22 (32') 13 SLATINEK S.
MAOUA N. 2 (2') 0	22 (33') 14 PIPP U.
DARMOUL M. 3 (3') 0	BACHA H. 23 (34') 14
3 (4') 1 SLATINEK S.	23 (34') 15 SIKOSEK D.
3 (4') 2 SLATINEK S.	23 (35') 16 KLJUN T.
BACHA H. 4 (4') 2	23 (36') 17 PIPP U.
4 (5') 3 KLJUN T.	JABALLAH J. 24 (36') 17
BACHA H. 5 (6') 3	24 (37') 18 PIPP U.
TOUMI G. 6 (8') 3	24 (41') 19 ZAGAR M.
6 (8') 4 HORVAT G.	BOUGHANMI O. 25 (42') 19
RZIG I. 7 (9') 4	BOUGHANMI O. 26 (42') 19
7 (10') 5 DROBEZ J.	26 (43') 20 SLATINEK S.
CHOUIREF M. 8 (10') 5	26 (44') 21 GRMSEK T.
8 (12') 6 SLATINEK S.	ABDELLI B. 27 (44') 21
DARMOUL M. 9 (13') 6	27 (45') 22 ZAGAR M.
MAAREF Y. 10 (14') 6	27 (45') 23 ZAGAR M.
DARMOUL M. 11 (15') 6	DARMOUL M. 28 (46') 23
11 (16') 7 PIPP U.	28 (46') 24 COKAN T.
11 (16') 8 MILICEVIC U.	BOUGHANMI O. 29 (47') 24
MAAREF Y. 12 (17') 8	29 (48') 25 COKAN T.
RZIG I. 13 (17') 8	29 (49') 26 SLATINEK S.
BOUGHANMI O. 14 (19') 8	MAAREF Y. 30 (50') 26
MAAREF Y. 15 (20') 8	TOUMI G. 31 (50') 26
MAAREF Y. 16 (20') 8	31 (51') 27 KOTAR M.
MAAREF Y. 17 (22') 8	JABALLAH J. 32 (52') 27
RZIG I. 18 (24') 8	32 (53') 28 KOTAR M.
18 (25') 9 ZAGAR M.	MAAREF Y. 33 (53') 28
MAAREF Y. 19 (25') 9	33 (54') 29 TAJNIK D.
RZIG I. 20 (26') 9	33 (56') 30 COKAN T.
20 (27') 10 COKAN T.	33 (58') 31 SLATINEK S.
BOUGHANMI O. 21 (27') 10	BANNOUR A. 34 (58') 31
21 (28') 11 KOTAR M.	34 (59') 32 COKAN T.
21 (28') 12 MILICEVIC U.	TOUMI G. 35 (60') 32
JABALLAH J. 22 (30') 12	35 (60') 33 ZAGAR M.
	BANNOUR A. 36 (60') 33
	36 (60') 34 DROBEZ J.

#### LEGEND

% Efficiency	(C) Captain	2Min 2 minutes suspension	6m 6 metre Shots
7m 7 metre Shots	7mS 7metre Saves	9m 9 metre Shots	BC Blue Cards
BT Break Through Shots	FB Fast Break Shots	G / S Goals/Shots	No. Uniform Number
RC Red Cards	S Saves	Wing Wing Shots	YC Yellow Card



THU 30 JUN 2022

Results

Start Time 12:00

Game Duration: 01:35

EGY 30 vs 26 TUN

(15-13) (15-13)

Referees: Marta SA (POR) Vania SA (POR)

EGY - Egypt

Players		Shots								Punishment			
No.	Name	G / S	%	6m	Wing	9m	7m	FB	BT	YC	2Min	RC	BC
10	ABDOU Abdelrahman												
17	NASRALLA Ahmed	0/1	0	0/1									
21	ABOUSALEM Mohamed												
24	ELMASRY Ibrahim										1		
31	ELWAKIL Omar	1/3	33	0/1	1/1			0/1					
39	ELDERAA Yehia	5/7	71	3/5		2/2					1		
42	KADDAH Hassan	4/7	57	2/3		2/4					1		
45	ELDERAA Seif	2/4	50	2/2	0/1	0/1							
48	ABDELHAK Mohab	4/8	50	1/3		3/5							
53	SAAD Akram												
66	ELAHMAR Ahmed (C)	4/8	50		1/2	0/2	3/3	0/1					
80	MESILHY Ahmed	6/8	75	6/8							1		
88	HENDAWY Karim												
90	MOHAMED Ali	2/3	67	2/2		0/1							
91	SANAD Mohammd	2/2	100		2/2								
96	ELTAYAR Mohamed												
<b>Bench/Team Totals</b>		30/51	59	16/25	4/6	7/15	3/3	0/2			4		

Goalkeepers		Saves							
No.	Name	S / S	%	6m	Wing	9m	7m	FB	BT
88	HENDAWY Karim	1/10	10	1/3	0/3	0/1	0/1	0/2	
96	ELTAYAR Mohamed	9/26	35	1/6	3/3	3/10	1/3	1/4	
<b>Totals</b>		10/36	28	2/9	3/6	3/11	1/4	1/6	

TUN - Tunisia

Players		Shots								Punishment			
No.	Name	G / S	%	6m	Wing	9m	7m	FB	BT	YC	2Min	RC	BC
9	BANNOUR Amine (C)	3/5	60	2/2	1/2	0/1							
10	ABDELLI Bilel	3/7	43	0/1		3/5		0/1					
13	BHAR Mohamed Ali												
21	BOUGHANMI Oussama	6/7	86		1/2		2/2	3/3			2		
22	MAAREF Yousef	4/7	57	1/2		3/5					1		
27	RZIG Issam	2/4	50		0/1		1/2	1/1					
28	BACHA Hazem												
45	MUSTAPHA Ala	0/1	0			0/1							
55	TOUMI Ghassen	1/3	33		1/2			0/1					
57	MAOUA Nouredine	0/2	0		0/1	0/1					1	1	
61	BELKAIED Yassine												
69	JABALLAH Jihed	1/1	100	1/1							1		
71	DARMOUL Mohamed Amine	4/7	57	2/4		2/3							
90	CHOUREF Marouan	2/2	100	1/1				1/1			1		
92	JAZIRI Oussama	0/1	0			0/1					1		
94	HARBAOUI Mehdi Sadri												
<b>Bench/Team Totals</b>		26/47	55	7/11	3/8	8/17	3/4	5/7		1	6	1	

Goalkeepers		Saves							
No.	Name	S / S	%	6m	Wing	9m	7m	FB	BT
61	BELKAIED Yassine	17/46	37	8/24	2/6	5/12	0/2	2/2	
94	HARBAOUI Mehdi Sadri	0/1	0			0/1			
<b>Totals</b>		17/47	36	8/24	2/6	5/12	0/3	2/2	





THU 30 JUN 2022

Start Time 12:00

Game Duration: 01:35

## Results

## RUNNING SCORE

## EGY - TUN

1st Half	2nd Half
0 (1') 1 CHOUIREF M.	MESILHY A. 16 (31') 13
KADDAH H. 1 (2') 1	16 (31') 14 DARMOUL M.
1 (2') 2 BANNOUR A.	16 (32') 15 MAAREF Y.
KADDAH H. 2 (4') 2	ELDERAA Y. 17 (33') 15
ABDELHAK M. 3 (4') 2	17 (37') 16 CHOUIREF M.
ABDELHAK M. 4 (5') 2	KADDAH H. 18 (38') 16
4 (6') 3 TOUMI G.	18 (38') 17 DARMOUL M.
ELDERAA Y. 5 (7') 3	ABDELHAK M. 19 (39') 17
5 (9') 4 BOUGHANMI O.	19 (39') 18 RZIG I.
KADDAH H. 6 (11') 4	MESILHY A. 20 (40') 18
6 (11') 5 JABALLAH J.	20 (41') 19 DARMOUL M.
ELDERAA Y. 7 (12') 5	ELAHMAR A. 21 (42') 19
7 (13') 6 BOUGHANMI O.	21 (44') 20 BOUGHANMI O.
ELWAKIL O. 8 (14') 6	ELDERAA S. 22 (45') 20
MESILHY A. 9 (16') 6	ABDELHAK M. 23 (46') 20
ELDERAA Y. 10 (17') 6	23 (47') 21 ABDELLI B.
10 (17') 7 BOUGHANMI O.	MESILHY A. 24 (47') 21
SANAD M. 11 (18') 7	24 (48') 22 BOUGHANMI O.
11 (20') 8 RZIG I.	24 (49') 23 ABDELLI B.
MOHAMED A. 12 (20') 8	MESILHY A. 25 (49') 23
12 (21') 9 DARMOUL M.	ELAHMAR A. 26 (51') 23
12 (22') 10 BANNOUR A.	ELDERAA Y. 27 (54') 23
ELAHMAR A. 13 (25') 10	27 (54') 24 MAAREF Y.
13 (26') 11 MAAREF Y.	SANAD M. 28 (57') 24
MOHAMED A. 14 (27') 11	28 (58') 25 ABDELLI B.
14 (29') 12 BANNOUR A.	ELDERAA S. 29 (59') 25
ELAHMAR A. 15 (29') 12	MESILHY A. 30 (60') 25
15 (30') 13 MAAREF Y.	30 (60') 26 BOUGHANMI O.

## LEGEND

%	Efficiency	(C)	Captain	2Min	2 minutes suspension	6m	6 metre Shots
7m	7 metre Shots	7mS	7metre Saves	9m	9 metre Shots	BC	Blue Cards
BT	Break Through Shots	FB	Fast Break Shots	G / S	Goals/Shots	No.	Uniform Number
RC	Red Cards	S	Saves	Wing	Wing Shots	YC	Yellow Card



THU 30 JUN 2022

Results

Start Time 14:00

Game Duration: 01:33

ITA 33 vs 34 SRB  
(16-15) (17-19)

Referees: Mahieddine GHOUL (ALG) Oussama CHERGUI (ALG)

ITA - Italy

Players		Shots							Punishment				
No.	Name	G / S	%	6m	Wing	9m	7m	FB	BT	YC	2Min	RC	BC
1	VOLAREVIC Mate												
2	MORETTI Alessio	1/5	20	0/2		0/2	1/1						
4	PRANTNER Leo												
5	DAPIRAN Gianluca												
6	BULZAMINI Davide	1/2	50	1/2									
8	SAVINI Giacomo	3/4	75	3/3		0/1							
10	MENGON Marco	5/7	71	2/3		2/3		1/1					
11	D'ANTINO Nicolo'	6/8	75	2/2	3/5			1/1					
12	COLLELUORI Andrea												
14	ARCIERI Stefano	7/9	78	2/2	5/6			0/1					
15	MENGON Simone	2/7	29	1/1		0/5		1/1			1		
18	MARTINI Oliver												
19	BORTOLI Thomas	2/2	100	1/1	1/1								
22	OPPEDISANO Axel	0/1	0				0/1						
32	PARISINI Andrea Carlo (C)	5/8	63	4/6		0/1		1/1					
66	PRANTNER Max	1/2	50	1/2									
<b>Bench/Team</b>													
<b>Totals</b>		33/55	60	17/24	9/12	2/12	1/2	4/5			1		

Goalkeepers		Saves							
No.	Name	S / S	%	6m	Wing	9m	7m	FB	BT
1	VOLAREVIC Mate	12/46	26	4/20	2/3	4/15	0/2	2/6	
12	COLLELUORI Andrea								
<b>Totals</b>		12/46	26	4/20	2/3	4/15	0/2	2/6	

SRB - Serbia

Players		Shots							Punishment				
No.	Name	G / S	%	6m	Wing	9m	7m	FB	BT	YC	2Min	RC	BC
1	BOMASTAR Milan												
3	VORKAPIC Vukasin	2/4	50	1/1	0/1			1/2					
5	MILIC Milan	8/12	67	3/4		5/7		0/1		1	2		
6	BORZAS Uros	4/13	31	1/3		3/10					2		
12	JANDRIC Todor												
16	TRNAVAC Andrej												
17	KOJADINOVIC Uros	2/2	100	1/1				1/1					
18	PAVLOVIC Uros											1	
20	GOLUBOVIC Milan												
23	POPOVIC Veljko	1/2	50	1/1				0/1					
24	VIGNJEVIC Marko												
28	SOTIC Mladen (C)	1/1	100	1/1									
33	PETRIC Stefan	0/1	0	0/1									
34	POPOVIC Ivan	7/7	100	6/6				1/1			1		
39	MILOSAVLJEVIC Marko	4/8	50	1/3		3/5					1		
69	GROZDANIC Milos	5/6	83	1/1	1/2		2/2	1/1					
<b>Bench/Team</b>										1			
<b>Totals</b>		34/56	61	16/22	1/3	11/22	2/2	4/7		2	6	1	

Goalkeepers		Saves							
No.	Name	S / S	%	6m	Wing	9m	7m	FB	BT
1	BOMASTAR Milan	18/51	35	7/24	3/12	6/8	1/2	1/5	
12	JANDRIC Todor								
<b>Totals</b>		18/51	35	7/24	3/12	6/8	1/2	1/5	



THU 30 JUN 2022

Start Time 14:00

Game Duration: 01:33

## Results

### RUNNING SCORE

1st Half		2nd Half	
0 (2')	1 VORKAPIC V.	MENGON M.	17 (32') 15
BULZAMINI D.	1 (2') 1	PARISINI A.	18 (33') 15
PRANTNER M.	2 (4') 1	18 (34') 16 MILIC M.	
2 (4') 2 BORZAS U.		18 (35') 17 VORKAPIC V.	
2 (5') 3 BORZAS U.		SAVINI G.	19 (36') 17
2 (7') 4 GROZDANIC M.		PARISINI A.	20 (36') 17
ARCIERI S.	3 (8') 4	20 (38') 18 GROZDANIC M.	
3 (8') 5 MILOSAVLJEVIC		MENGON M.	21 (39') 18
MENGON M.	4 (8') 5	21 (40') 19 KOJADINOVIC U.	
MENGON M.	5 (9') 5	ARCIERI S.	22 (40') 19
MENGON S.	6 (10') 5	22 (40') 20 BORZAS U.	
6 (11') 6 POPOVIC I.		ARCIERI S.	23 (41') 20
6 (14') 7 MILOSAVLJEVIC		23 (42') 21 MILOSAVLJEVIC	
D'ANTINO N.	7 (15') 7	MENGON S.	24 (42') 21
PARISINI A.	8 (16') 7	24 (43') 22 SOTIC M.	
8 (16') 8 POPOVIC I.		ARCIERI S.	25 (43') 22
8 (17') 9 POPOVIC I.		D'ANTINO N.	26 (44') 22
D'ANTINO N.	9 (18') 9	26 (45') 23 POPOVIC I.	
ARCIERI S.	10 (19') 9	D'ANTINO N.	27 (45') 23
PARISINI A.	11 (20') 9	27 (47') 24 KOJADINOVIC U.	
ARCIERI S.	12 (22') 9	D'ANTINO N.	28 (47') 24
12 (24') 10 GROZDANIC M.		28 (48') 25 POPOVIC I.	
BORTOLI T.	13 (24') 10	28 (49') 26 POPOVIC I.	
13 (25') 11 MILIC M.		28 (50') 27 GROZDANIC M.	
13 (25') 12 POPOVIC V.		28 (50') 28 MILIC M.	
MENGON M.	14 (27') 12	28 (53') 29 MILOSAVLJEVIC	
14 (27') 13 MILIC M.		MORETTI A.	29 (54') 29
D'ANTINO N.	15 (27') 13	29 (54') 30 MILIC M.	
15 (29') 14 GROZDANIC M.		PARISINI A.	30 (55') 30
BORTOLI T.	16 (30') 14	30 (57') 31 MILIC M.	
16 (30') 15 POPOVIC I.		30 (58') 32 MILIC M.	
		SAVINI G.	31 (58') 32
		31 (58') 33 BORZAS U.	
		SAVINI G.	32 (58') 33
		32 (60') 34 MILIC M.	
		ARCIERI S.	33 (60') 34

#### LEGEND

%	Efficiency	(C)	Captain	2Min	2 minutes suspension	6m	6 metre Shots
7m	7 metre Shots	7mS	7 metre Saves	9m	9 metre Shots	BC	Blue Cards
BT	Break Through Shots	FB	Fast Break Shots	G / S	Goals/Shots	No.	Uniform Number
RC	Red Cards	S	Saves	Wing	Wing Shots	YC	Yellow Card



FRI 1 JUL 2022

Results

Start Time 12:00

Game Duration: 01:41

**TUN 34 vs 29 ITA**  
(18-15) (16-14)

Referees: Metodija ILIEVSKI (MKD) Mihajlo ILIEVSKI (MKD)

**TUN - Tunisia**

No.	Name	Players		Shots						Punishment			
		G / S	%	6m	Wing	9m	7m	FB	BT	YC	2Min	RC	BC
9	BANNOUR Amine (C)	1/1	100			1/1							
10	ABDELLI Bilel	5/8	63	1/1	2/4	1/2		1/1					
13	BHAR Mohamed Ali	8/9	89	2/2	3/3			3/4					
21	BOUGHANMI Oussama	8/11	73	1/1		0/1	4/4	3/5					
22	MAAREF Yousef	2/3	67			2/3							
27	RZIG Issam												
28	BACHA Hazem	5/9	56			5/8		0/1					
45	MUSTAPHA Ala												
55	TOUMI Ghassen												
57	MAOUA Noureddine	0/1	0		0/1						1		
61	BELKAIED Yassine												
69	JABALLAH Jihed	2/5	40	1/3	1/1	0/1							
71	DARMOUL Mohamed Amine												
90	CHOUREF Marouan	3/5	60	3/5							1		
92	JAZIRI Oussama												
94	HARBAOUI Mehdi Sadri												
<b>Bench/Team</b>											1		
<b>Totals</b>		34/52	65	8/12	6/9	9/16	4/4	7/11			1	2	

Goalkeepers		Saves							
No.	Name	S / S	%	6m	Wing	9m	7m	FB	BT
61	BELKAIED Yassine	6/20	30	5/11	1/3	0/3		0/3	
94	HARBAOUI Mehdi Sadri	7/22	32	3/13	1/2	1/2	2/4	0/1	
<b>Totals</b>		13/42	31	8/24	2/5	1/5	2/4	0/4	

**ITA - Italy**

No.	Name	Players		Shots						Punishment			
		G / S	%	6m	Wing	9m	7m	FB	BT	YC	2Min	RC	BC
1	VOLAREVIC Mate												
2	MORETTI Alessio	6/12	50	2/4	0/1	2/4	2/3				2		
4	PRANTNER Leo	7/7	100	2/2	2/2			3/3					
5	DAPIRAN Gianluca	3/4	75	2/2	1/2								
6	BULZAMINI Davide	2/3	67	1/1		1/2					1		
8	SAVINI Giacomo	0/1	0	0/1									
9	MENGON Marco	3/6	50	2/4		1/2					1		
11	D'ANTINO Nicolo'												
12	COLLELUORI Andrea												
14	ARCIERI Stefano	1/1	100					1/1			1		
15	MENGON Simone	1/2	50	1/2									
18	MARTINI Oliver												
19	BORTOLI Thomas	4/5	80	4/4	0/1								
22	OPPEDISANO Axel	0/1	0				0/1						
32	PARISINI Andrea Carlo (C)	2/6	33	2/6									
66	PRANTNER Max												
<b>Bench/Team</b>											1		
<b>Totals</b>		29/48	60	16/26	3/6	4/8	2/4	4/4			1	5	

Goalkeepers		Saves							
No.	Name	S / S	%	6m	Wing	9m	7m	FB	BT
1	VOLAREVIC Mate	2/13	15	1/3	0/3	1/2	0/2	0/3	
12	COLLELUORI Andrea	6/29	21	3/9	0/3	1/9	0/2	2/6	
<b>Totals</b>		8/42	19	4/12	0/6	2/11	0/4	2/9	



FRI 1 JUL 2022

Start Time 12:00

Game Duration: 01:41

## Results

### RUNNING SCORE

1st Half	
0 (2)	1 BORTOLI T.
BACHA H. 1 (2)	1
1 (2)	2 BORTOLI T.
1 (4)	3 MORETTI A.
BACHA H. 2 (4)	3
2 (5)	4 BORTOLI T.
BOUGHANMI O. 3 (6)	4
3 (7)	5 MORETTI A.
BACHA H. 4 (8)	5
4 (8)	6 PARISINI A.
BANNOUR A. 5 (9)	6
BACHA H. 6 (10)	6
6 (11)	7 BORTOLI T.
CHOUIREF M. 7 (11)	7
BOUGHANMI O. 8 (12)	7
8 (13)	8 DAPIRAN G.
BOUGHANMI O. 9 (13)	8
9 (14)	9 DAPIRAN G.
BOUGHANMI O. 10 (14)	9
10 (15)	10 BULZAMINI D.
BOUGHANMI O. 11 (15)	10
CHOUIREF M. 12 (16)	10
BHAR M. 13 (17)	10
13 (18)	11 DAPIRAN G.
BHAR M. 14 (18)	11
14 (22)	12 MORETTI A.
14 (25)	13 PRANTNER L.
ABDELLI B. 15 (28)	13
15 (28)	14 MENGON M.
MAAREF Y. 16 (29)	14
ABDELLI B. 17 (30)	14
17 (30)	15 MENGON M.
MAAREF Y. 18 (30)	15

2nd Half	
BOUGHANMI O. 19 (33)	15
ABDELLI B. 20 (33)	15
20 (34)	16 PRANTNER L.
ABDELLI B. 21 (35)	16
BHAR M. 22 (36)	16
22 (37)	17 PARISINI A.
22 (38)	18 PRANTNER L.
BOUGHANMI O. 23 (39)	18
23 (40)	19 MORETTI A.
23 (40)	20 ARCIERI S.
JABALLAH J. 24 (41)	20
24 (42)	21 MORETTI A.
24 (42)	22 PRANTNER L.
24 (44)	23 MENGON S.
24 (45)	24 PRANTNER L.
BACHA H. 25 (46)	24
25 (46)	25 MORETTI A.
ABDELLI B. 26 (47)	25
BOUGHANMI O. 27 (48)	25
27 (49)	26 BULZAMINI D.
JABALLAH J. 28 (50)	26
28 (54)	27 MENGON M.
BHAR M. 29 (54)	27
BHAR M. 30 (55)	27
BHAR M. 31 (56)	27
31 (57)	28 PRANTNER L.
BHAR M. 32 (59)	28
CHOUIREF M. 33 (60)	28
BHAR M. 34 (60)	28
34 (60)	29 PRANTNER L.

#### LEGEND

%	Efficiency	(C)	Captain	2Min	2 minutes suspension	6m	6 metre Shots
7m	7 metre Shots	7mS	7metre Saves	9m	9 metre Shots	BC	Blue Cards
BT	Break Through Shots	FB	Fast Break Shots	G / S	Goals/Shots	No.	Uniform Number
RC	Red Cards	S	Saves	Wing	Wing Shots	YC	Yellow Card



SAT 2 JUL 2022

Results

Start Time 14:15

Game Duration: 01:33

SRB 35 vs 29 TUN  
(19-13) (16-16)

Referees: Luis DIAZ FLORES GOMEZ (ESP) Enrique PEREZ GONZALEZ (ESP)

SRB - Serbia

No.	Name	Players		Shots						Punishment				
		G / S	%	6m	Wing	9m	7m	FB	BT	YC	2Min	RC	BC	
1	BOMASTAR Milan													
3	VORKAPIC Vukasin	7/11	64	2/2	2/6			3/3						
5	MILIC Milan	3/6	50	1/1	0/1	2/4								
6	BORZAS Uros	6/8	75	3/4	1/1	1/2		1/1						
12	JANDRIC Todor													
16	TRNAVAC Andrej													
17	KOJADINOVIC Uros	1/1	100	1/1										
18	PAVLOVIC Uros	2/3	67	2/2	0/1									
20	GOLUBOVIC Milan													
23	POPOVIC Veliko													
24	VIGNJEVIC Marko													
28	SOTIC Mladen (C)													
33	PETRIC Stefan	3/3	100			3/3								
34	POPOVIC Ivan	4/5	80	4/5						1	3			
39	MILOSAVLJEVIC Marko	4/5	80	2/2		1/2		1/1						
69	GROZDANIC Milos	5/6	83	0/1	1/1		4/4							
<b>Bench/Team</b>														
<b>Totals</b>		35/48	73	15/18	4/10	7/11	4/4	5/5		1	3			

Goalkeepers		Saves							
No.	Name	S / S	%	6m	Wing	9m	7m	FB	BT
1	BOMASTAR Milan								
12	JANDRIC Todor	18/47	38	4/21	5/9	6/8	2/4	1/5	
<b>Totals</b>		18/47	38	4/21	5/9	6/8	2/4	1/5	

TUN - Tunisia

No.	Name	Players		Shots						Punishment				
		G / S	%	6m	Wing	9m	7m	FB	BT	YC	2Min	RC	BC	
9	BANNOUR Amine (C)	1/5	20	1/1		0/4								
10	ABDELLI Bilel	2/3	67	2/2		0/1								
13	BHAR Mohamed Ali													
21	BOUGHANMI Oussama	3/9	33	1/1	1/5	0/1	1/2							
22	MAAREF Yousef	0/1	0		0/1									
27	RZIG Issam	8/9	89	2/2	2/2		1/2	3/3						
28	BACHA Hazem	4/7	57	2/3		2/4								
45	MUSTAPHA Ala													
55	TOUMI Ghassen	2/2	100	1/1				1/1			1			
57	MAOUA Nouredine	1/1	100		1/1									
61	BELKAIED Yassine													
69	JABALLAH Jihed	6/7	86	6/7							1			
71	DARMOUL Mohamed Amine	1/5	20	1/3		0/1		0/1						
90	CHOUIREF Marouan	1/2	50	1/2							1			
92	JAZIRI Oussama										1			
<b>Bench/Team</b>										1				
<b>Totals</b>		29/51	57	17/22	4/9	2/11	2/4	4/5		1	4			

Goalkeepers		Saves							
No.	Name	S / S	%	6m	Wing	9m	7m	FB	BT
61	BELKAIED Yassine	4/20	20	1/9	3/3	0/4	0/2	0/2	
<b>Totals</b>		4/20	20	1/9	3/3	0/4	0/2	0/2	



SAT 2 JUL 2022

Start Time 14:15

Game Duration: 01:33

## Results

### RUNNING SCORE

1st Half		2nd Half	
POPOVIC I.	1 (1') 0	19 (32') 14	BACHA H.
MILOSAVLJEVIC	2 (2') 0	19 (33') 15	RZIG I.
	2 (3') 1	20 (34') 15	PETRIC S.
	CHOUIREF M.	20 (34') 16	ABDELLI B.
POPOVIC I.	3 (3') 1	21 (35') 16	POPOVIC I.
VORKAPIC V.	4 (4') 1	21 (35') 17	JABALLAH J.
	4 (5') 2	22 (36') 17	PETRIC S.
	BOUGHANMI O.	23 (37') 17	MILOSAVLJEVIC
MILOSAVLJEVIC	5 (5') 2	23 (37') 18	JABALLAH J.
BORZAS U.	6 (8') 2	24 (38') 18	VORKAPIC V.
VORKAPIC V.	7 (9') 2	25 (39') 18	VORKAPIC V.
	7 (10') 3	25 (39') 19	BACHA H.
	BANNOUR A.	26 (41') 19	PETRIC S.
	BOUGHANMI O.	26 (42') 20	RZIG I.
GROZDANIC M.	8 (11') 4	26 (43') 21	RZIG I.
	8 (12') 5	26 (45') 22	RZIG I.
	RZIG I.	26 (47') 23	RZIG I.
	8 (14') 6	26 (47') 24	TOUMI G.
	BOUGHANMI O.	27 (49') 24	MILIC M.
BORZAS U.	9 (15') 6	27 (49') 25	DARMOUL M.
VORKAPIC V.	10 (15') 6	28 (50') 25	GROZDANIC M.
	10 (16') 7	28 (51') 26	JABALLAH J.
	BACHA H.	29 (52') 26	BORZAS U.
BORZAS U.	11 (17') 7	30 (52') 26	KOJADINOVIC U.
BORZAS U.	12 (18') 7	31 (55') 26	GROZDANIC M.
	12 (19') 8	31 (55') 27	JABALLAH J.
	BACHA H.	32 (57') 27	POPOVIC I.
VORKAPIC V.	13 (19') 8	33 (58') 27	MILOSAVLJEVIC
VORKAPIC V.	14 (21') 8	33 (59') 28	JABALLAH J.
	14 (22') 9	34 (60') 28	BORZAS U.
	MAOUA N.	35 (60') 28	PAVLOVIC U.
PAVLOVIC U.	15 (22') 9	35 (60') 29	TOUMI G.
GROZDANIC M.	16 (23') 9		
	16 (24') 10		
	ABDELLI B.		
	16 (26') 11		
	RZIG I.		
MILIC M.	17 (28') 11		
	17 (28') 12		
	JABALLAH J.		
	17 (29') 13		
	RZIG I.		
MILIC M.	18 (29') 13		
GROZDANIC M.	19 (30') 13		

#### LEGEND

%	Efficiency	(C)	Captain	2Min	2 minutes suspension	6m	6 metre Shots
7m	7 metre Shots	7mS	7 metre Saves	9m	9 metre Shots	BC	Blue Cards
BT	Break Through Shots	FB	Fast Break Shots	G / S	Goals/Shots	No.	Uniform Number
RC	Red Cards	S	Saves	Wing	Wing Shots	YC	Yellow Card



MON 27 JUN 2022

**Results**

Start Time 18:00

Game Duration: 01:38

**TUR 27 vs 32 ALG**

(14-15) (13-17)

Referees: Marta SA (POR) Vania SA (POR)

**TUR - Turkiye**

Players		Shots								Punishment			
No.	Name	G / S	%	6m	Wing	9m	7m	FB	BT	YC	2Mi	RC	BC
8	TINKIR Durmus Ali	2/2	100	1/1		1/1							
9	ILANC Genco	0/2	0			0/2				1			
12	YATKIN Enis												
16	GOKTEPE Coskun												
17	BICER Gorkem	4/6	67	1/2	1/2		1/1	1/1					
24	OZTURK Halil Ibrahim	4/7	57	2/3		2/4							
30	BABACAN Ali Emre	0/1	0			0/1							
32	KELESOGLU Ilkan	1/1	100			1/1				2			
33	ATES Yasar Erdem	0/3	0	0/1	0/1			0/1					
34	YAGMUROGLU Sevket	4/4	100		3/3			1/1					
52	AYDIN Alper	1/2	50	1/2						2			
53	KANBEROGLU Samet	0/1	0		0/1						1		
61	PEHLIVAN Omur	5/6	83	4/4		1/2							
70	DURMAZ Tolga	3/3	100	3/3									
77	BILIM Gokay	1/1	100			1/1							
78	SIRIN Atakan	2/4	50	2/3		0/1							
<b>Bench/Team Totals</b>		27/43	63	14/19	4/7	6/13	1/1	2/3			5	2	1

Goalkeepers		Saves							
No.	Name	S / S	%	6m	Win	9m	7m	FB	BT
12	YATKIN Enis								
16	GOKTEPE Coskun	15/46	33	3/18	4/7	7/17	1/1	0/3	
61	PEHLIVAN Omur								
<b>Totals</b>		15/46	33	3/18	4/7	7/17	1/1	0/3	

**ALG - Algeria**

Players		Shots								Punishment			
No.	Name	G / S	%	6m	Wing	9m	7m	FB	BT	YC	2Mi	RC	BC
2	NAIM Zohir	0/1	0			0/1							
3	CHEHBOUR Nabil												
4	HELLAL Nour-eddine	3/3	100	1/1		1/1		1/1		2			
6	BERKOUS Messaoud	6/11	55	3/4		3/6	0/1						
10	REMILI Hamza												
15	SAKER Redouane	1/3	33		1/3								
16	ZEMOUCHI Yahia A												
17	DJEDID Yacine	3/5	60	1/1	0/2			2/2		1			
18	KAABECHE Hichem	1/1	100	1/1									
22	GHEDBANE Khalifa	1/1	100			1/1							
26	KOURI Mokhtar	1/3	33	1/2		0/1							
36	RAHIM Abdelkader	4/4	100	2/2		2/2							
44	HADJ SADOK Moustafa	2/5	40	2/2		0/2	0/1			1	1	1	
77	ARIB Reda	4/5	80	1/1	2/3	1/1							
87	ABDI Ayyoub	5/9	56	2/3		2/5		1/1		1			
94	KHERMOUCHE Bastien Jean R	1/1	100	1/1									
<b>Bench/Team Totals</b>		32/52	62	15/18	3/8	10/20	0/2	4/4		1	5	1	

Goalkeepers		Saves							
No.	Name	S / S	%	6m	Win	9m	7m	FB	BT
4	HELLAL Nour-eddine								
16	ZEMOUCHI Yahia A								
22	GHEDBANE Khalifa	13/40	33	5/19	2/6	5/11	0/1	1/3	
<b>Totals</b>		13/40	33	5/19	2/6	5/11	0/1	1/3	





MON 27 JUN 2022

Start Time 18:00

Game Duration: 01:38

## Results

### RUNNING SCORE

#### TUR - ALG

1st Half	2nd Half
<b>0</b> (2') <b>1</b> ABDI A.	OZTURK H. <b>15</b> (31') <b>15</b>
<b>0</b> (4') <b>2</b> RAHIM A.	<b>15</b> (31') <b>16</b> HADJ SADOK M.
<b>0</b> (5') <b>3</b> KHERMOUCHE B.	TINKIR D. <b>16</b> (33') <b>16</b>
BICER G. <b>1</b> (5') <b>3</b>	<b>16</b> (33') <b>17</b> ABDI A.
<b>1</b> (6') <b>4</b> ABDI A.	<b>16</b> (33') <b>18</b> ARIB R.
BILIM G. <b>2</b> (6') <b>4</b>	DURMAZ T. <b>17</b> (36') <b>18</b>
<b>2</b> (7') <b>5</b> ABDI A.	<b>17</b> (37') <b>19</b> HADJ SADOK M.
<b>2</b> (8') <b>6</b> RAHIM A.	<b>17</b> (37') <b>20</b> HELLAL N.
OZTURK H. <b>3</b> (9') <b>6</b>	<b>17</b> (38') <b>21</b> DJEDID Y.
<b>3</b> (9') <b>7</b> BERKOUS M.	<b>17</b> (40') <b>22</b> ARIB R.
OZTURK H. <b>4</b> (10') <b>7</b>	<b>17</b> (42') <b>23</b> ARIB R.
<b>4</b> (10') <b>8</b> BERKOUS M.	BICER G. <b>18</b> (43') <b>23</b>
PEHLIVAN O. <b>5</b> (11') <b>8</b>	TINKIR D. <b>19</b> (44') <b>23</b>
<b>5</b> (12') <b>9</b> RAHIM A.	BICER G. <b>20</b> (45') <b>23</b>
AYDIN A. <b>6</b> (12') <b>9</b>	OZTURK H. <b>21</b> (45') <b>23</b>
BICER G. <b>7</b> (13') <b>9</b>	<b>21</b> (46') <b>24</b> ARIB R.
<b>7</b> (16') <b>10</b> KOURI M.	<b>21</b> (49') <b>25</b> BERKOUS M.
<b>7</b> (18') <b>11</b> GHEDBANE K.	<b>21</b> (50') <b>26</b> BERKOUS M.
DURMAZ T. <b>8</b> (18') <b>11</b>	<b>21</b> (50') <b>27</b> DJEDID Y.
YAGMUROGLU S. <b>9</b> (19') <b>11</b>	PEHLIVAN O. <b>22</b> (51') <b>27</b>
<b>9</b> (20') <b>12</b> ABDI A.	PEHLIVAN O. <b>23</b> (52') <b>27</b>
YAGMUROGLU S. <b>10</b> (22') <b>12</b>	<b>23</b> (54') <b>28</b> HELLAL N.
YAGMUROGLU S. <b>11</b> (23') <b>12</b>	SIRIN A. <b>24</b> (54') <b>28</b>
<b>11</b> (24') <b>13</b> BERKOUS M.	<b>24</b> (55') <b>29</b> KAABECHE H.
DURMAZ T. <b>12</b> (24') <b>13</b>	PEHLIVAN O. <b>25</b> (57') <b>29</b>
<b>12</b> (27') <b>14</b> RAHIM A.	<b>25</b> (58') <b>30</b> BERKOUS M.
YAGMUROGLU S. <b>13</b> (28') <b>14</b>	PEHLIVAN O. <b>26</b> (58') <b>30</b>
<b>13</b> (28') <b>15</b> SAKER R.	<b>26</b> (58') <b>31</b> HELLAL N.
KELESOGLU I. <b>14</b> (30') <b>15</b>	<b>26</b> (59') <b>32</b> DJEDID Y.
	SIRIN A. <b>27</b> (60') <b>32</b>

#### LEGEND

% Efficiency	(C) Captain	2Min 2 minutes suspension	6m 6 metre Shots
7m 7 metre Shots	7mS 7metre Saves	9m 9 metre Shots	BC Blue Cards
BT Break Through Shots	FB Fast Break Shots	G / S Goals/Shots	No. Uniform Number
RC Red Cards	S Saves	Wing Wing Shots	YC Yellow Card



MON 27 JUN 2022

Results

Start Time 20:00

Game Duration: 01:24

**MKD 39 vs 21 GRE**  
(20-13) (19-8)

Referees: Dragana JAKOVLJEVIC (SRB) Danieja KOVACEVIC (SRB)

**MKD - North Macedonia**

Players		Shots								Punishment			
No.	Name	G / S	%	6m	Wing	9m	7m	FB	BT	YC	2Mi	RC	BC
8	DJONOV Ivan	6/6	100	1/1	4/4	1/1							
9	GJORGIEV Igor	4/5	80	3/3		1/2							
10	MITEV Marko	1/3	33		0/1	1/2							
19	KOSTESKI Nenad	5/6	83	1/1	2/2	1/1		1/1	0/1				
20	KIZIKJ Marko												
21	PETKOVSKI Aleksandar	3/4	75		3/3	0/1							
23	IVANOSKI Mihail	0/1	0	0/1									
31	MLADENOVIKJ Mihailo												
34	JAGURINOSKI Tomislav	0/1	0			0/1							
42	STOJKOVIKJ Marko	1/1	100	1/1									
55	ATANASIJEVIKJ Petar	5/6	83	2/2	3/3			0/1			1		
77	SERAFIMOV Martin	7/10	70	2/2		2/4	3/4						
88	SIMONOSKI Kristijan	2/3	67	2/2			0/1						
89	ATANASIJEVIKJ Pavle	3/4	75		0/1	2/2		1/1					
92	PETROV Kostadin	2/2	100	2/2									
98	GOGOVI Vasil												
<b>Bench/Team Totals</b>		39/52	75	14/15	12/14	8/14	3/5	2/3	0/1		1		

Goalkeepers		Saves							
No.	Name	S / S	%	6m	Win	9m	7m	FB	BT
20	KIZIKJ Marko	19/40	48	3/13	4/5	12/19	0/2	0/1	
98	GOGOVI Vasil								
<b>Totals</b>		19/40	48	3/13	4/5	12/19	0/2	0/1	

**GRE - Greece**

Players		Shots								Punishment			
No.	Name	G / S	%	6m	Wing	9m	7m	FB	BT	YC	2Mi	RC	BC
2	STEFANITSIS Ioannis	2/2	100				2/2						
3	SINA Armando	3/5	60	2/2	1/3								
5	STATHIS Michail Nektarios	0/1	0			0/1							
6	PAGIATIS Eleftherios	5/8	63	4/7				1/1					
7	PAPAGIANNIS Christos	1/2	50			1/2							
8	TZORTZINIS Nikolaos	0/1	0		0/1								
9	PAPAZOGLU Athanasios	2/4	50		0/1	2/3							
11	DIKAIOLIAS Nikolaos Marios	2/2	100	2/2								1	
12	BAMPATZANIDIS Dimitrios												
13	ALEXANDRIDIS Pantelis Leonidas												
15	TOSKAS Achilleas	1/4	25	1/1		0/3					1		
17	ANASTASIOU Eleftherios	2/4	50	0/1		2/3					1		
18	PANAGIOTOU Dimitrios	0/3	0	0/1		0/2					1		
19	KOTSIONIS Konstantinos	3/9	33	1/1		2/8							
21	GEROULANOS Andreas												
30	ASLIS Nikolaos												
<b>Bench/Team Totals</b>		21/45	47	10/15	1/5	7/22	2/2	1/1		1	3	1	

Goalkeepers		Saves							
No.	Name	S / S	%	6m	Win	9m	7m	FB	BT
12	BAMPATZANIDIS Dimitrios	8/41	20	1/14	1/11	4/11	0/1	1/3	1/1
30	ASLIS Nikolaos	2/8	25	0/1	0/2	1/2	1/3		
<b>Totals</b>		10/49	20	1/15	1/13	5/13	1/4	1/3	1/1



MON 27 JUN 2022

## Results

Start Time 20:00

Game Duration: 01:24

### RUNNING SCORE

#### MKD - GRE

1st Half	2nd Half
ATANASIJEVIKJ <b>1</b> (1') <b>0</b>	SERAFIMOV M. <b>21</b> (32') <b>13</b>
<b>1</b> (3') <b>1</b> SINA A.	PETKOVSKI A. <b>22</b> (33') <b>13</b>
KOSTESKI N. <b>2</b> (3') <b>1</b>	ATANASIJEVIKJ <b>23</b> (34') <b>13</b>
<b>2</b> (3') <b>2</b> DIKAIOLIAS N.	ATANASIJEVIKJ <b>24</b> (35') <b>13</b>
<b>2</b> (6') <b>3</b> ANASTASIOU E.	<b>24</b> (38') <b>14</b> PAPAGIANNIS C.
KOSTESKI N. <b>3</b> (8') <b>3</b>	SERAFIMOV M. <b>25</b> (38') <b>14</b>
<b>3</b> (8') <b>4</b> DIKAIOLIAS N.	GJORGIEV I. <b>26</b> (39') <b>14</b>
ATANASIJEVIKJ <b>4</b> (9') <b>4</b>	<b>26</b> (40') <b>15</b> TOSKAS A.
KOSTESKI N. <b>5</b> (10') <b>4</b>	SERAFIMOV M. <b>27</b> (41') <b>15</b>
<b>5</b> (11') <b>5</b> KOTSIONIS K.	PETKOVSKI A. <b>28</b> (42') <b>15</b>
KOSTESKI N. <b>6</b> (12') <b>5</b>	<b>28</b> (43') <b>16</b> PAGIATIS E.
<b>6</b> (13') <b>6</b> ANASTASIOU E.	SIMONOSKI K. <b>29</b> (44') <b>16</b>
GJORGIEV I. <b>7</b> (14') <b>6</b>	<b>29</b> (45') <b>17</b> STEFANITSIS I.
<b>7</b> (14') <b>7</b> SINA A.	STOJKOVIKJ M. <b>30</b> (46') <b>17</b>
GJORGIEV I. <b>8</b> (15') <b>7</b>	<b>30</b> (46') <b>18</b> PAGIATIS E.
<b>8</b> (15') <b>8</b> STEFANITSIS I.	MITEV M. <b>31</b> (47') <b>18</b>
DJONOV I. <b>9</b> (16') <b>8</b>	ATANASIJEVIKJ <b>32</b> (48') <b>18</b>
<b>9</b> (16') <b>9</b> PAGIATIS E.	PETKOVSKI A. <b>33</b> (50') <b>18</b>
ATANASIJEVIKJ <b>10</b> (17') <b>9</b>	<b>33</b> (50') <b>19</b> KOTSIONIS K.
<b>10</b> (18') <b>10</b> PAGIATIS E.	DJONOV I. <b>34</b> (51') <b>19</b>
GJORGIEV I. <b>11</b> (18') <b>10</b>	<b>34</b> (52') <b>20</b> PAPAZOGLU A.
KOSTESKI N. <b>12</b> (18') <b>10</b>	SIMONOSKI K. <b>35</b> (52') <b>20</b>
SERAFIMOV M. <b>13</b> (21') <b>10</b>	PETROV K. <b>36</b> (53') <b>20</b>
SERAFIMOV M. <b>14</b> (22') <b>10</b>	DJONOV I. <b>37</b> (54') <b>20</b>
<b>14</b> (22') <b>11</b> SINA A.	DJONOV I. <b>38</b> (56') <b>20</b>
SERAFIMOV M. <b>15</b> (23') <b>11</b>	ATANASIJEVIKJ <b>39</b> (58') <b>20</b>
SERAFIMOV M. <b>16</b> (25') <b>11</b>	<b>39</b> (60') <b>21</b> PAPAZOGLU A.
DJONOV I. <b>17</b> (27') <b>11</b>	
ATANASIJEVIKJ <b>18</b> (29') <b>11</b>	
PETROV K. <b>19</b> (30') <b>11</b>	
<b>19</b> (30') <b>12</b> KOTSIONIS K.	
DJONOV I. <b>20</b> (30') <b>12</b>	
<b>20</b> (30') <b>13</b> PAGIATIS E.	

#### LEGEND

% Efficiency	(C) Captain	2Min 2 minutes suspension	6m 6 metre Shots
7m 7 metre Shots	7mS 7metre Saves	9m 9 metre Shots	BC Blue Cards
BT Break Through Shots	FB Fast Break Shots	G / S Goals/Shots	No. Uniform Number
RC Red Cards	S Saves	Wing Wing Shots	YC Yellow Card



TUE 28 JUN 2022

**Results**

Start Time 18:00

Game Duration: 01:43

**ALG 24 vs 24 MKD**  
 (15-15) (9-9)

**Referees:** Joana Filipa FERREIRA DA SILVA (POR) Lia Barbara DA SILVA PIN

**ALG - Algeria**

Players			Shots							Punishment			
No.	Name	G / S	%	6m	Wing	9m	7m	FB	BT	YC	2Mi	RC	BC
2	NAIM Zohir	4/12	33	3/4		1/8							
3	CHEHBOUR Nabil	0/1	0			0/1							
4	HELLAL Nour-eddine										1	1	
6	BERKOUS Messaoud	3/6	50	3/3		0/2	0/1						
10	REMILI Hamza												
15	SAKER Redouane	7/8	88	1/1	2/2	1/1	2/3	1/1					
16	ZEMOUCHI Yahia A												
17	DJEDID Yacine	5/6	83		4/4			1/2			1		
18	KAABECHE Hichem	0/1	0	0/1									
22	GHEDBANE Khalifa												
26	KOURI Mokhtar	0/1	0			0/1					2		
36	RAHIM Abdelkader	0/1	0			0/1							
44	HADJ SADOK Moustafa	2/3	67	2/2		0/1							
77	ARIB Reda	2/3	67	0/1	1/1		1/1						
87	ABDI Avyoub	1/6	17	0/1		1/5					1		
94	KHERMOUCHE Bastien Jean R												
<b>Bench/Team</b>													
<b>Totals</b>		24/48	50	9/13	7/7	3/20	3/5	2/3			5	1	

Goalkeepers		Saves							
No.	Name	S / S	%	6m	Win	9m	7m	FB	BT
16	ZEMOUCHI Yahia A	0/2	0	0/1			0/1		
22	GHEDBANE Khalifa	16/38	42	7/15	2/4	4/9	2/6	1/4	
<b>Totals</b>		16/40	40	7/16	2/4	4/9	2/7	1/4	

**MKD - North Macedonia**

Players			Shots							Punishment			
No.	Name	G / S	%	6m	Wing	9m	7m	FB	BT	YC	2Mi	RC	BC
8	DJONOV Ivan	3/8	38	1/3		1/3	1/2						
9	GJORGIEV Igor	3/4	75	1/2		2/2							
10	MITEV Marko	3/4	75	3/4						1			
19	KOSTESKI Nenad	1/4	25		1/2	0/1		0/1					
20	KIZIKJ Marko												
21	PETKOVSKI Aleksandar	1/3	33		1/2		0/1						
23	IVANOSKI Mihail												
31	MLADENOVIKJ Mihailo	0/1	0	0/1							1		
34	JAGURINOSKI Tomislav	3/7	43	1/2		0/3		2/2					
42	STOJKOVIKJ Marko	1/1	100	1/1							1		
55	ATANASIJEVIKJ Petar	1/2	50	1/1		0/1					1		
77	SERAFIMOV Martin	5/9	56			1/3	4/6				1		
88	SIMONOSKI Kristijan												
89	ATANASIJEVIKJ Pavle	2/3	67	0/1		1/1		1/1			1		
92	PETROV Kostadin	1/3	33	1/3									
98	GOGOVI Vasil												
<b>Bench/Team</b>										1			
<b>Totals</b>		24/49	49	9/18	2/4	5/14	5/9	3/4		2	5		

Goalkeepers		Saves							
No.	Name	S / S	%	6m	Win	9m	7m	FB	BT
20	KIZIKJ Marko	10/20	50	3/6	0/1	6/8	1/4	0/1	
98	GOGOVI Vasil	6/20	30	0/6	0/6	5/6		1/2	
<b>Totals</b>		16/40	40	3/12	0/7	11/14	1/4	1/3	



TUE 28 JUN 2022

Start Time 18:00

Game Duration: 01:43

## Results

### RUNNING SCORE

#### ALG - MKD

1st Half	2nd Half
<b>0</b> (1') <b>1</b> STOJKOVIKJ M.	SAKER R. <b>16</b> (31') <b>15</b>
<b>0</b> (3') <b>2</b> ATANASIJEVIKJ	NAIM Z. <b>17</b> (35') <b>15</b>
SAKER R. <b>1</b> (3') <b>2</b>	ARIB R. <b>18</b> (36') <b>15</b>
<b>1</b> (5') <b>3</b> JAGURINOSKI T.	<b>18</b> (37') <b>16</b> DJONOV I.
<b>1</b> (6') <b>4</b> JAGURINOSKI T.	<b>18</b> (38') <b>17</b> GJORGIEV I.
BERKOUS M. <b>2</b> (9') <b>4</b>	<b>18</b> (41') <b>18</b> GJORGIEV I.
DJEDID Y. <b>3</b> (9') <b>4</b>	ABDI A. <b>19</b> (42') <b>18</b>
<b>3</b> (10') <b>5</b> DJONOV I.	<b>19</b> (43') <b>19</b> PETROV K.
SAKER R. <b>4</b> (10') <b>5</b>	<b>19</b> (45') <b>20</b> KOSTESKI N.
<b>4</b> (11') <b>6</b> JAGURINOSKI T.	<b>19</b> (46') <b>21</b> GJORGIEV I.
BERKOUS M. <b>5</b> (15') <b>6</b>	<b>19</b> (51') <b>22</b> SERAFIMOV M.
<b>5</b> (16') <b>7</b> SERAFIMOV M.	ARIB R. <b>20</b> (52') <b>22</b>
DJEDID Y. <b>6</b> (16') <b>7</b>	NAIM Z. <b>21</b> (55') <b>22</b>
<b>6</b> (17') <b>8</b> SERAFIMOV M.	NAIM Z. <b>22</b> (55') <b>22</b>
BERKOUS M. <b>7</b> (17') <b>8</b>	HADJ SADOK M. <b>23</b> (57') <b>22</b>
<b>7</b> (18') <b>9</b> MITEV M.	DJEDID Y. <b>24</b> (58') <b>22</b>
HADJ SADOK M. <b>8</b> (20') <b>9</b>	<b>24</b> (58') <b>23</b> DJONOV I.
NAIM Z. <b>9</b> (20') <b>9</b>	<b>24</b> (59') <b>24</b> MITEV M.
<b>9</b> (21') <b>10</b> SERAFIMOV M.	
SAKER R. <b>10</b> (21') <b>10</b>	
<b>10</b> (22') <b>11</b> PETKOVSKI A.	
SAKER R. <b>11</b> (24') <b>11</b>	
<b>11</b> (24') <b>12</b> MITEV M.	
SAKER R. <b>12</b> (25') <b>12</b>	
<b>12</b> (25') <b>13</b> SERAFIMOV M.	
SAKER R. <b>13</b> (26') <b>13</b>	
DJEDID Y. <b>14</b> (26') <b>13</b>	
<b>14</b> (27') <b>14</b> ATANASIJEVIKJ	
DJEDID Y. <b>15</b> (29') <b>14</b>	
<b>15</b> (30') <b>15</b> ATANASIJEVIKJ	

#### LEGEND

% Efficiency	(C) Captain	2Min 2 minutes suspension	6m 6 metre Shots
7m 7 metre Shots	7mS 7metre Saves	9m 9 metre Shots	BC Blue Cards
BT Break Through Shots	FB Fast Break Shots	G / S Goals/Shots	No. Uniform Number
RC Red Cards	S Saves	Wing Wing Shots	YC Yellow Card



TUE 28 JUN 2022

Results

Start Time 20:00

Game Duration: 01:16

ESP 46 vs 19 TUR  
(26-7) (20-12)

Referees: Sid Ali HAMIDI (ALG) Youcef BELKHIRI (ALG)

ESP - Spain

Players		Shots								Punishment			
No.	Name	G / S	%	6m	Wing	9m	7m	FB	BT	YC	2Mi	RC	BC
16	RODRIGUEZ LARIO Roberto												
18	GARCIANDIA ALUSTIZA Imanol	3/4	75	1/2	1/1	1/1							
23	BAZAN LEGASA Antonio	1/1	100		1/1						2		
31	VALERA ROVIRA Pol	2/2	100	2/2									
36	TARRAFETA SERRANO Ian	3/3	100	1/1		2/2							
49	MARTINEZ LOBATO Miquel	4/6	67	2/2		0/1		2/3					
55	IZQUIERDO LABAYEN Ander	1/2	50	1/1		0/1							
58	MARQUEZ COLOMA Jose Maria	2/3	67	0/1		1/1		1/1					
61	HERNANDEZ FERRER Sergey												
62	ODRIOZOLA YEREGUI Kauldi	4/6	67	1/2			3/3	0/1					
63	FOLQUES ORTIZ Josep	6/7	86	1/1	1/2	1/1		3/3					
64	SERRANO VILLOBOS Jorge	7/9	78	4/4	2/3	0/1	1/1						
70	FERNANDEZ JIMENEZ Daniel	5/5	100	1/1	1/1			3/3					
72	GALLEGO MURO Jaime	2/2	100	2/2									
73	NIETO MARCOS Asier	5/6	83	3/3	1/1			1/2					
74	MARTIN BOTET Alberto	1/1	100	1/1									
<b>Bench/Team</b>													
<b>Totals</b>		46/57	81	20/23	7/9	5/8	4/4	10/13			2		

Goalkeepers		Saves							
No.	Name	S / S	%	6m	Win	9m	7m	FB	BT
16	RODRIGUEZ LARIO Roberto	7/20	35	2/11	1/2	4/6	0/1		
61	HERNANDEZ FERRER Sergey	10/16	63	1/6	1/1	7/8		1/1	
<b>Totals</b>		17/36	47	3/17	2/3	11/14	0/1	1/1	

TUR - Turkiye

Players		Shots								Punishment			
No.	Name	G / S	%	6m	Wing	9m	7m	FB	BT	YC	2Mi	RC	BC
8	TINKIR Durmus Ali	1/3	33	0/1		1/2							
9	ILANC Genco	1/4	25			1/4					2		
12	YATKIN Enis												
16	GOKTEPE Coskun												
17	BICER Gorkem	2/4	50	2/2	0/1	0/1							
24	OZTURK Halil Ibrahim	2/5	40	1/1		1/4					1		
30	BABACAN Ali Emre	1/2	50	1/1		0/1							
32	KELESOGLU Ilkan	3/3	100	3/3									
33	ATES Yasar Erdem												
34	YAGMUROGLU Sevket	0/3	0	0/1	0/1			0/1					
52	AYDIN Alper									1			
53	KANBEROGLU Samet	0/2	0		0/1		0/1						
61	PEHLIVAN Omur	4/7	57	3/3	1/1	0/3					1		
70	DURMAZ Tolga	4/5	80	4/5									
77	BILIM Gokay	1/3	33			0/2	1/1						
78	SIRIN Atakan	0/1	0	0/1									
<b>Bench/Team</b>													
<b>Totals</b>		19/42	45	14/18	1/4	3/17	1/2	0/1		1	4		

Goalkeepers		Saves							
No.	Name	S / S	%	6m	Win	9m	7m	FB	BT
12	YATKIN Enis	2/22	9	0/11	1/6	0/2	0/2	1/3	
16	GOKTEPE Coskun	2/28	7	0/9	0/2	0/5	0/2	2/10	
<b>Totals</b>		4/50	8	0/20	1/8	0/5	0/4	3/13	



TUE 28 JUN 2022

Start Time 20:00

Game Duration: 01:16

## Results

### RUNNING SCORE

#### ESP - TUR

1st Half		2nd Half	
TARRAFETA I.	1 (1') 0	SERRANO J.	27 (32') 7
GARCIANDIA I.	2 (3') 0	SERRANO J.	28 (34') 7
FERNANDEZ D.	3 (4') 0	28 (34') 8	ILANC G.
ODRIOZOLA K.	4 (5') 0	SERRANO J.	29 (35') 8
GARCIANDIA I.	5 (6') 0	29 (35') 9	PEHLIVAN O.
5 (7') 1	DURMAZ T.	MARTINEZ M.	30 (36') 9
TARRAFETA I.	6 (8') 1	30 (36') 10	BICER G.
FERNANDEZ D.	7 (8') 1	VALERA P.	31 (37') 10
FERNANDEZ D.	8 (9') 1	31 (37') 11	DURMAZ T.
8 (9') 2	DURMAZ T.	SERRANO J.	32 (38') 11
BAZAN A.	9 (10') 2	32 (39') 12	OZTURK H.
MARQUEZ J.	10 (12') 2	SERRANO J.	33 (40') 12
FERNANDEZ D.	11 (12') 2	FOLQUES J.	34 (41') 12
MARQUEZ J.	12 (12') 2	34 (42') 13	PEHLIVAN O.
ODRIOZOLA K.	13 (14') 2	ODRIOZOLA K.	35 (43') 13
13 (15') 3	BILIM G.	SERRANO J.	36 (44') 13
TARRAFETA I.	14 (15') 3	FOLQUES J.	37 (45') 13
GALLEGO J.	15 (17') 3	37 (46') 14	PEHLIVAN O.
FOLQUES J.	16 (19') 3	FERNANDEZ D.	38 (46') 14
16 (21') 4	KELESOGLU I.	38 (48') 15	KELESOGLU I.
MARTINEZ M.	17 (21') 4	GALLEGO J.	39 (48') 15
FOLQUES J.	18 (22') 4	NIETO A.	40 (49') 15
NIETO A.	19 (23') 4	MARTINEZ M.	41 (50') 15
MARTIN A.	20 (23') 4	41 (51') 16	OZTURK H.
20 (23') 5	DURMAZ T.	41 (51') 17	BICER G.
VALERA P.	21 (24') 5	NIETO A.	42 (52') 17
MARTINEZ M.	22 (25') 5	42 (52') 18	PEHLIVAN O.
22 (25') 6	BABACAN A.	NIETO A.	43 (55') 18
NIETO A.	23 (26') 6	43 (55') 19	KELESOGLU I.
FOLQUES J.	24 (27') 6	IZQUIERDO A.	44 (56') 19
FOLQUES J.	25 (28') 6	GARCIANDIA I.	45 (58') 19
25 (29') 7	TINKIR D.	ODRIOZOLA K.	46 (60') 19
SERRANO J.	26 (30') 7		

#### LEGEND

%	Efficiency	(C)	Captain	2Min	2 minutes suspension	6m	6 metre Shots
7m	7 metre Shots	7mS	7metre Saves	9m	9 metre Shots	BC	Blue Cards
BT	Break Through Shots	FB	Fast Break Shots	G / S	Goals/Shots	No.	Uniform Number
RC	Red Cards	S	Saves	Wing	Wing Shots	YC	Yellow Card



THU 30 JUN 2022

**Results**

Start Time 17:00

Game Duration: 01:21

**MKD 22 vs 31 ESP**

(8-14) (14-17)

Referees: Danijela SANDO KOVACEVIC (SRB) Dragana JAKOVLJEVIC (SRB)

**MKD - North Macedonia**

No.	Name	G / S	%	Shots					Punishment					
				6m	Wing	9m	7m	FB	BT	YC	2Min	RC	BC	
8	DJONOV Ivan	2/4	50	1/2		1/2						1		
9	GJORGIEV Igor	1/2	50	1/1		0/1								
10	MITEV Marko	2/5	40	1/2	0/1	1/2								
19	KOSTESKI Nenad	1/2	50	1/1	0/1									
20	KIZIKJ Marko													
21	PETKOVSKI Aleksandar	1/2	50		1/2									
23	IVANOSKI Mihail										1	1		
31	MLADENOVIKJ Mihajlo	1/4	25	1/1		0/3								
34	JAGURINOSKI Tomislav (C)	1/1	100			1/1						1		
42	STOJKOVIKJ Marko	1/1	100	1/1										
55	ATANASIJEVIKJ Petar	1/2	50			0/1			1/1					
77	SERAFIMOV Martin	8/15	53	0/1	0/1	1/6	7/7							
88	SIMONOSKI Kristijan	0/1	0			0/1								
89	ATANASIJEVIKJ Pavle	1/6	17		0/1	1/5								
92	PETROV Kostadin	2/2	100	2/2										
98	GGOV Vasil													
<b>Bench/Team</b>												1		
<b>Totals</b>		22/47	47	8/11	1/6	5/22	7/7	1/1			2	3		

Goalkeepers		Saves							
No.	Name	S / S	%	6m	Wing	9m	7m	FB	BT
20	KIZIKJ Marko	14/41	34	5/14	2/8	7/13	0/1	0/5	
98	GGOV Vasil	3/7	43	2/3	1/1		0/3		
<b>Totals</b>		17/48	35	7/17	3/9	7/13	0/4	0/5	

**ESP - Spain**

No.	Name	G / S	%	Shots					Punishment					
				6m	Wing	9m	7m	FB	BT	YC	2Min	RC	BC	
16	RODRIGUEZ LARIO Roberto													
18	GARCIANDIA ALUSTIZA Imanol	1/8	13	0/1	0/1	1/6								
23	BAZAN LEGASA Antonio	3/4	75	2/3				1/1				1		
31	VALERA ROVIRA Pol	2/4	50	1/1		1/3								
36	TARRAFETA SERRANO Ian	2/6	33	1/2	0/1	1/3								
49	MARTINEZ LOBATO Miquel	3/4	75	2/3		1/1								
55	IZQUIERDO LABAYEN Ander	1/4	25	0/2		1/2								
58	MARQUEZ COLOMA Jose Maria	2/3	67			1/2		1/1				1		
61	HERNANDEZ FERRER Sergey (C)											1		
62	ODRIOZOLA YEREGUI Kauldi	4/4	100		1/1		2/2	1/1						
63	FOLQUES ORTIZ Josep	2/2	100		1/1			1/1						
64	SERRANO VILLALOBOS Jorge	4/6	67		1/3		2/2	1/1						
70	FERNANDEZ JIMENEZ Daniel	4/6	67	1/2	3/4									
72	GALLEGO MURO Jaime	2/3	67	2/3										
73	NIETO MARCOS Asier	1/2	50	1/2										
74	MARTIN BOTET Alberto													
<b>Bench/Team</b>														
<b>Totals</b>		31/56	55	10/19	6/11	6/17	4/4	5/5				3		

Goalkeepers		Saves							
No.	Name	S / S	%	6m	Wing	9m	7m	FB	BT
16	RODRIGUEZ LARIO Roberto	0/4	0	0/1			0/3		
61	HERNANDEZ FERRER Sergey	17/35	49	3/10	3/4	11/16	0/4	0/1	
<b>Totals</b>		17/39	44	3/11	3/4	11/16	0/7	0/1	





THU 30 JUN 2022

Start Time 17:00

Game Duration: 01:21

## Results

### RUNNING SCORE

1st Half		MKD - ESP		2nd Half	
0 (2)	1 MARQUEZ J.	SERAFIMOV M.	9 (31)	14	
0 (3)	2 FERNANDEZ D.		9 (32)	15 GALLEGO J.	
SERAFIMOV M.	1 (3)	2	SERAFIMOV M.	10 (33)	15
GJORGIEV I.	2 (5)	2	10 (33)	16 MARTINEZ M.	
SERAFIMOV M.	3 (8)	2	DJONOV I.	11 (34)	16
3 (8)	3 BAZAN A.		11 (35)	17 IZQUIERDO A.	
MLADENOVIKJ M.	4 (8)	3	11 (35)	18 FOLQUES J.	
4 (9)	4 ODRIOZOLA K.		11 (36)	19 BAZAN A.	
4 (10)	5 FERNANDEZ D.		DJONOV I.	12 (36)	19
4 (11)	6 MARQUEZ J.		12 (39)	20 MARTINEZ M.	
4 (14)	7 GALLEGO J.		JAGURINOSKI T.	13 (40)	20
SERAFIMOV M.	5 (15)	7	13 (41)	21 BAZAN A.	
5 (16)	8 ODRIOZOLA K.		13 (43)	22 VALERA P.	
STOJKOVIKJ M.	6 (16)	8	13 (43)	23 SERRANO J.	
ATANASJJEVIKJ	7 (19)	8	13 (44)	24 SERRANO J.	
7 (21)	9 FERNANDEZ D.		13 (45)	25 TARRAFETA I.	
7 (22)	10 TARRAFETA I.		MITEV M.	14 (45)	25
7 (23)	11 ODRIOZOLA K.		PETROV K.	15 (46)	25
7 (25)	12 VALERA P.		15 (47)	26 GARCIANDIA I.	
7 (28)	13 ODRIOZOLA K.		SERAFIMOV M.	16 (48)	26
PETKOVSKI A.	8 (29)	13	KOSTESKI N.	17 (49)	26
8 (30)	14 MARTINEZ M.		17 (49)	27 FOLQUES J.	
			ATANASJJEVIKJ	18 (50)	27
			18 (51)	28 FERNANDEZ D.	
			18 (52)	29 SERRANO J.	
			MITEV M.	19 (55)	29
			19 (56)	30 NIETO A.	
			SERAFIMOV M.	20 (56)	30
			SERAFIMOV M.	21 (58)	30
			21 (60)	31 SERRANO J.	
			PETROV K.	22 (60)	31

#### LEGEND

%	Efficiency	(C)	Captain	2Min	2 minutes suspension	6m	6 metre Shots
7m	7 metre Shots	7mS	7metre Saves	9m	9 metre Shots	BC	Blue Cards
BT	Break Through Shots	FB	Fast Break Shots	G / S	Goals/Shots	No.	Uniform Number
RC	Red Cards	S	Saves	Wing	Wing Shots	YC	Yellow Card



THU 30 JUN 2022

Results

Start Time 19:00

Game Duration: 01:26

GRE 25 vs 35 ALG

(13-17) (12-18)

Referees: Luis DIAZ FLORES GOMEZ (ESP) Enrique PEREZ GONZALEZ (ESP)

GRE - Greece

No.	Name	Players				Shots					Punishment			
		G / S	%	6m	Wing	9m	7m	FB	BT	YC	2Min	RC	BC	
2	STEFANITSIS Ioannis	3/3	100		2/2		1/1							
3	SINA Armando													
5	STATHIS Michail Nektarios													
6	PAGIATIS Eleftherios	1/2	50	1/1		0/1								
7	PAPAGIANNIS Christos	3/6	50	1/2	2/4									
8	TZORTZINIS Nikolaos (C)	2/3	67	0/1	2/2									
9	PAPAZOGLU Athanasios	3/7	43	1/1		1/5		1/1						
11	DIKAIOULIAS Nikolaos Marios	4/6	67	4/6							1			
12	BAMPATZANIDIS Dimitrios													
13	ALEXANDRIDIS Pantelis Leonidas	0/2	0	0/1		0/1					1			
15	TOSKAS Achilleas	1/4	25				1/4							
17	ANASTASIOU Eleftherios	2/4	50			2/4								
18	PANAGIOTOU Dimitrios	3/6	50	1/2	0/1	2/3					1			
19	KOTSIONIS Konstantinos	3/8	38			3/8					1			
21	GEROULANOS Andreas													
30	ASLIS Nikolaos													
Bench/Team														
Totals		25/51	49	8/14	6/9	9/26	1/1	1/1			4			

Goalkeepers		Saves							
No.	Name	S / S	%	6m	Wing	9m	7m	FB	BT
6	PAGIATIS Eleftherios								
12	BAMPATZANIDIS Dimitrios	8/43	19	3/11	3/9	2/11	0/3	0/9	
30	ASLIS Nikolaos								
Totals		8/43	19	3/11	3/9	2/11	0/3	0/9	

ALG - Algeria

No.	Name	Players				Shots					Punishment			
		G / S	%	6m	Wing	9m	7m	FB	BT	YC	2Min	RC	BC	
2	NAIM Zohir	7/13	54	3/6		4/7								
3	CHEHBOUR Nabil	0/2	0		0/2									
4	HELLAL Nour-eddine	2/2	100	1/1				1/1		1				
6	BERKOUS Messaoud (C)													
9	MELAZEM Wail	2/2	100			1/1	1/1				1			
10	REMILI Hamza													
15	SAKER Redouane	6/7	86		1/1		2/3	3/3						
16	ZEMOUCHI Yahia A													
17	DJEDID Yacine	6/8	75		2/4			4/4						
18	KAABECHE Hichem	1/3	33	1/2		0/1								
22	GHEDBANE Khalifa													
26	KOURI Mokhtar	1/1	100			1/1					1			
36	RAHIM Abdelkader	2/3	67	1/2				1/1						
44	HADJ SADOK Moustafa	3/5	60	0/2		3/3								
77	ARIB Reda	3/4	75	0/1	3/3									
94	KHERMOUCHE Bastien Jean R	2/3	67	2/3										
Bench/Team														
Totals		35/53	66	8/17	6/10	9/13	3/4	9/9		1	2			

Goalkeepers		Saves							
No.	Name	S / S	%	6m	Wing	9m	7m	FB	BT
16	ZEMOUCHI Yahia A	5/17	29	2/4	1/4	2/8		0/1	
22	GHEDBANE Khalifa	11/24	46	3/9	1/4	7/10	0/1		
Totals		16/41	39	5/13	2/8	9/18	0/1	0/1	



THU 30 JUN 2022

Start Time 19:00

Game Duration: 01:26

## Results

## RUNNING SCORE

1st Half		2nd Half	
PAPAGIANNIS C.	1 (2') 0	13 (31') 18	NAIM Z.
KOTSIONIS K.	2 (4') 0	13 (32') 19	DJEDID Y.
	2 (4') 1	14 (32') 19	STEFANITSIS I.
	2 (4') 2	14 (33') 20	HELLAL N.
	2 (5') 3	15 (33') 20	TOSKAS A.
	2 (6') 4	15 (34') 21	NAIM Z.
DIKAIOLIAS N.	3 (8') 4	15 (35') 22	DJEDID Y.
	3 (8') 5	16 (35') 22	KOTSIONIS K.
	3 (9') 6	16 (35') 23	NAIM Z.
	3 (10') 7	17 (35') 23	PAGIATIS E.
	3 (12') 8	17 (39') 24	ARIB R.
DIKAIOLIAS N.	4 (14') 8	18 (40') 24	TZORTZINIS N.
ANASTASIOU E.	5 (16') 8	18 (40') 25	DJEDID Y.
	5 (17') 9	18 (42') 26	KHERMOUCHE B.
	5 (18') 10	19 (42') 26	KOTSIONIS K.
STEFANITSIS I.	6 (19') 10	19 (44') 27	MELAZEM W.
PANAGIOTOU D.	7 (20') 10	20 (45') 27	ANASTASIOU E.
PAPAGIANNIS C.	8 (21') 10	20 (45') 28	MELAZEM W.
	8 (22') 11	21 (48') 28	DIKAIOLIAS N.
	9 (22') 11	21 (48') 29	NAIM Z.
PANAGIOTOU D.	9 (22') 11	22 (51') 29	PAPAZOGLU A.
PAPAGIANNIS C.	10 (23') 11	22 (51') 30	NAIM Z.
	10 (24') 12	23 (53') 30	PAPAZOGLU A.
	10 (24') 13	23 (53') 31	NAIM Z.
	10 (25') 14	23 (53') 31	NAIM Z.
	10 (26') 15	24 (55') 31	TZORTZINIS N.
DIKAIOLIAS N.	11 (29') 15	24 (56') 32	ARIB R.
	11 (29') 16	24 (57') 33	ARIB R.
STEFANITSIS I.	12 (29') 16	24 (58') 34	KAABECHE H.
	12 (30') 17	24 (59') 35	DJEDID Y.
PAPAZOGLU A.	13 (30') 17	25 (59') 35	PANAGIOTOU D.

## LEGEND

%	Efficiency	(C)	Captain	2Min	2 minutes suspension	6m	6 metre Shots
7m	7 metre Shots	7mS	7metre Saves	9m	9 metre Shots	BC	Blue Cards
BT	Break Through Shots	FB	Fast Break Shots	G / S	Goals/Shots	No.	Uniform Number
RC	Red Cards	S	Saves	Wing	Wing Shots	YC	Yellow Card



FRI 1 JUL 2022

## Results

Start Time 17:00

Game Duration: 01:16

ESP 46 vs 21 GRE  
(24-10) (22-11)

Referees: Joana Filipa FERREIRA DA SILVA (POR) Lia Barbara DA SILVA PINHERIO (POR)

## ESP - Spain

No.	Name	Players		Shots						Punishment			
		G / S	%	6m	Wing	9m	7m	FB	BT	YC	2Min	RC	BC
16	RODRIGUEZ LARIO Roberto												
18	GARCIANDIA ALUSTIZA Imanol	3/3	100	3/3									
23	BAZAN LEGASA Antonio	1/2	50	1/2									
31	VALERA ROVIRA Pol	2/2	100	2/2									
36	TARRAFETA SERRANO Ian	2/2	100			2/2							
49	MARTINEZ LOBATO Miquel	3/3	100	1/1		2/2							
55	IZQUIERDO LABAYEN Ander	3/3	100	2/2		1/1					2		
58	MARQUEZ COLOMA Jose Maria	5/7	71	1/2		4/5							
61	HERNANDEZ FERRER Sergey (C)												
62	ODRIOZOLA YEREGUI Kauldi	6/6	100	1/1	3/3	1/1		1/1					
63	FOLQUES ORTIZ Josep	6/8	75	1/1	3/5			2/2					
64	SERRANO VILLALOBOS Jorge	4/5	80		2/2		1/1	1/2					
70	FERNANDEZ JIMENEZ Daniel												
72	GALLEGO MURO Jaime	4/4	100	4/4									
73	NIETO MARCOS Asier	2/3	67	1/1	1/1	0/1							
74	MARTIN BOTET Alberto	5/5	100	4/4		1/1							
Bench/Team													
Totals		46/53	87	21/23	9/11	11/13	1/1	4/5			2		

Goalkeepers		Saves							
No.	Name	S / S	%	6m	Wing	9m	7m	FB	BT
16	RODRIGUEZ LARIO Roberto	18/39	46	8/19	3/6	7/14			
61	HERNANDEZ FERRER Sergey								
Totals		18/39	46	8/19	3/6	7/14			

## GRE - Greece

No.	Name	Players		Shots						Punishment			
		G / S	%	6m	Wing	9m	7m	FB	BT	YC	2Min	RC	BC
2	STEFANITSIS Ioannis	1/1	100		1/1								
3	SINA Armando	0/2	0	0/2									
5	STATHIS Michail Nektarios												
6	PAGIATIS Eleftherios	0/1	0			0/1							
7	PAPAGIANNIS Christos	1/2	50	1/1	0/1								
8	TZORTZINIS Nikolaos (C)	4/11	36	2/3	2/4	0/4					1		
9	PAPAZOGLOU Athanasios	3/4	75	2/2		1/2					1		
11	DIKAIOLIAS Nikolaos Marios	0/4	0	0/4									
12	BAMPATZANIDIS Dimitrios												
13	ALEXANDRIDIS Pantelis Leonidas	3/3	100	3/3									
15	TOSKAS Achilleas	4/7	57	2/2		2/5							
17	ANASTASIOU Eleftherios	1/3	33	0/1		1/2							
18	PANAGIOTOU Dimitrios	0/1	0	0/1									
21	GEROULANOS Andreas	4/7	57	1/1		3/6							
30	ASLIS Nikolaos												
Bench/Team													
Totals		21/46	46	11/20	3/6	7/20					2		

Goalkeepers		Saves							
No.	Name	S / S	%	6m	Wing	9m	7m	FB	BT
12	BAMPATZANIDIS Dimitrios	3/35	9	0/15	2/10	1/7		0/3	
30	ASLIS Nikolaos	2/16	13	1/7	0/1	1/6	0/1	0/1	
Totals		5/51	10	1/22	2/11	2/13	0/1	0/4	



FRI 1 JUL 2022

Start Time 17:00

Game Duration: 01:16

## Results

### RUNNING SCORE

#### ESP - GRE

1st Half		2nd Half	
TARRAFETA I.	1 (3') 0	VALERA P.	25 (31') 10
FOLQUES J.	2 (4') 0	ODRIOZOLA K.	26 (32') 10
GARCIANDIA I.	3 (5') 0		26 (32') 11 TOSKAS A.
TARRAFETA I.	4 (6') 0	MARTINEZ M.	27 (33') 11
	4 (7') 1 TOSKAS A.	ODRIOZOLA K.	28 (33') 11
NIETO A.	5 (7') 1		28 (34') 12 GEROULANOS A.
FOLQUES J.	6 (8') 1		28 (35') 13 TOSKAS A.
	6 (9') 2 TOSKAS A.	IZQUIERDO A.	29 (36') 13
SERRANO J.	7 (9') 2		29 (36') 14 PAPAGIANNIS C.
GARCIANDIA I.	8 (10') 2	MARTIN A.	30 (37') 14
FOLQUES J.	9 (10') 2		30 (38') 15 GEROULANOS A.
GARCIANDIA I.	10 (11') 2	IZQUIERDO A.	31 (38') 15
	10 (12') 3 TZORTZINIS N.	MARTIN A.	32 (39') 15
SERRANO J.	11 (12') 3	ODRIOZOLA K.	33 (40') 15
SERRANO J.	12 (14') 3		33 (41') 16 ALEXANDRIDIS P.
	12 (15') 4 PAPAZOGLOU A.	VALERA P.	34 (41') 16
BAZAN A.	13 (16') 4	ODRIOZOLA K.	35 (43') 16
MARQUEZ J.	14 (17') 4	IZQUIERDO A.	36 (44') 16
	14 (18') 5 PAPAZOGLOU A.		36 (45') 17 ANASTASIOU E.
	14 (19') 6 ALEXANDRIDIS P.	MARTIN A.	37 (47') 17
ODRIOZOLA K.	15 (20') 6	MARQUEZ J.	38 (49') 17
	15 (20') 7 ALEXANDRIDIS P.	FOLQUES J.	39 (50') 17
GALLEGO J.	16 (21') 7	FOLQUES J.	40 (51') 17
ODRIOZOLA K.	17 (22') 7		40 (52') 18 TZORTZINIS N.
	17 (23') 8 STEFANITSIS I.	FOLQUES J.	41 (52') 18
MARTINEZ M.	18 (23') 8		41 (55') 19 PAPAZOGLOU A.
GALLEGO J.	19 (24') 8	SERRANO J.	42 (56') 19
GALLEGO J.	20 (25') 8		42 (56') 20 TZORTZINIS N.
	20 (26') 9 TZORTZINIS N.	MARQUEZ J.	43 (57') 20
MARQUEZ J.	21 (26') 9	NIETO A.	44 (58') 20
GALLEGO J.	22 (28') 9	MARTIN A.	45 (59') 20
MARQUEZ J.	23 (29') 9		45 (60') 21 GEROULANOS A.
MARTINEZ M.	24 (29') 9	MARTIN A.	46 (60') 21
	24 (30') 10 GEROULANOS A.		

#### LEGEND

%	Efficiency	(C)	Captain	2Min	2 minutes suspension	6m	6 metre Shots
7m	7 metre Shots	7mS	7 metre Saves	9m	9 metre Shots	BC	Blue Cards
BT	Break Through Shots	FB	Fast Break Shots	G / S	Goals/Shots	No.	Uniform Number
RC	Red Cards	S	Saves	Wing	Wing Shots	YC	Yellow Card



FRI 1 JUL 2022

**Results**

Start Time 19:15

Game Duration: 01:28

**TUR 22 vs 31 MKD**

(12-13) (10-18)

Referees: Luis DIAZ FLORES GOMEZ (ESP) Enrique PEREZ GONZALEZ (ESP)

**TUR - Turkiye**

Players		Shots								Punishment			
No.	Name	G / S	%	6m	Wing	9m	7m	FB	BT	YC	2Min	RC	BC
8	TINKIR Durmus Ali	1/5	20	1/1	0/1	0/3					1		
9	ILANC Genco	1/1	100			1/1							
12	YATKIN Enis												
16	GOKTEPE Coskun										1		
17	BICER Gorkem	3/7	43		2/3	0/1	1/1	0/2					
24	OZTURK Halil Ibrahim (C)	1/5	20			1/5					1	1	
30	BABACAN Ali Emre	1/3	33	1/1		0/2							
32	KELESOGLU Ilkan										2		
33	ATES Yasar Erdem												
34	YAGMUROGLU Sevket	1/1	100		1/1								
52	AYDIN Alper	3/4	75	3/4							2		
53	KANBEROGLU Samet	1/4	25		1/2			0/2					
61	PEHLIVAN Omur	1/2	50	1/1		0/1						1	
70	DURMAZ Tolga	5/7	71	5/7							1		
77	BILIM Gokay	1/2	50	1/1		0/1							
78	SIRIN Atakan	3/6	50	2/3		1/3							
<b>Bench/Team</b>										1			
<b>Totals</b>		22/47	47	14/18	4/7	3/17	1/1	0/4		1	8	2	

Goalkeepers		Saves							
No.	Name	S / S	%	6m	Wing	9m	7m	FB	BT
12	YATKIN Enis	11/33	33	2/7	1/4	7/9	1/8	0/5	
16	GOKTEPE Coskun	6/15	40	1/3	2/5	2/4	1/2	0/1	
<b>Totals</b>		17/48	35	3/10	3/9	9/13	2/10	0/6	

**MKD - North Macedonia**

Players		Shots								Punishment			
No.	Name	G / S	%	6m	Wing	9m	7m	FB	BT	YC	2Min	RC	BC
8	DJONOV Ivan	2/4	50	0/1	1/2	1/1					1		
9	GJORGIEV Igor	4/7	57	1/1		2/5		1/1					
10	MITEV Marko	0/1	0			0/1							
19	KOSTESKI Nenad	2/2	100		1/1			1/1					
20	KIZIKJ Marko												
21	PETKOVSKI Aleksandar	11/12	92		2/2		8/9	1/1					
23	IVANOSKI Mihail										1		
31	MLADENOVIKJ Mihajlo	0/1	0			0/1							
34	JAGURINOSKI Tomislav (C)	1/1	100	1/1									
42	STOJKOVIKJ Marko	1/1	100					1/1					
55	ATANASIJEVIKJ Petar	4/8	50	1/1	2/5			1/2					
77	SERAFIMOV Martin	2/6	33	1/1		0/3	0/1	1/1			1		
88	SIMONOSKI Kristijan	1/2	50	1/2									
89	ATANASIJEVIKJ Pavle	0/2	0			0/2							
92	PETROV Kostadin	2/3	67	2/3									
98	GGOV Vasil	1/1	100			1/1							
<b>Bench/Team</b>													
<b>Totals</b>		31/51	61	7/10	6/10	4/14	8/10	6/7			3		

Goalkeepers		Saves							
No.	Name	S / S	%	6m	Wing	9m	7m	FB	BT
20	KIZIKJ Marko								
98	GGOV Vasil	18/40	45	3/17	2/6	9/12	0/1	4/4	
<b>Totals</b>		18/40	45	3/17	2/6	9/12	0/1	4/4	



FRI 1 JUL 2022

Start Time 19:15

Game Duration: 01:28

## Results

### RUNNING SCORE

1st Half	
DURMAZ T.	1 (1') 0
	1 (2') 1 ATANASIJEVIKJ
	1 (2') 2 JAGURINOSKI T.
	1 (4') 3 SIMONOSKI K.
KANBEROGLU S.	2 (8') 3
	2 (9') 4 PETKOVSKI A.
	2 (10') 5 PETKOVSKI A.
	2 (11') 6 GJORGIEV I.
BICER G.	3 (13') 6
BICER G.	4 (15') 6
BICER G.	5 (16') 6
TINKIR D.	6 (17') 6
	6 (18') 7 GJORGIEV I.
	6 (19') 8 PETKOVSKI A.
ILANC G.	7 (19') 8
	7 (21') 9 PETKOVSKI A.
	7 (22') 10 GJORGIEV I.
DURMAZ T.	8 (24') 10
	8 (25') 11 PETKOVSKI A.
	8 (26') 12 PETKOVSKI A.
YAGMUROGLU S.	9 (27') 12
DURMAZ T.	10 (28') 12
SIRIN A.	11 (29') 12
	11 (30') 13 DJONOV I.
SIRIN A.	12 (30') 13

2nd Half	
	12 (33') 14 PETKOVSKI A.
	12 (34') 15 KOSTESKI N.
OZTURK H.	13 (35') 15
	13 (36') 16 DJONOV I.
	13 (38') 17 SERAFIMOV M.
DURMAZ T.	14 (38') 17
DURMAZ T.	15 (42') 17
	15 (42') 18 PETROV K.
	15 (43') 19 SERAFIMOV M.
	15 (44') 20 ATANASIJEVIKJ
	15 (45') 21 STOJKOVIKJ M.
	15 (46') 22 PETKOVSKI A.
	15 (47') 23 GJORGIEV I.
SIRIN A.	16 (47') 23
	16 (48') 24 PETKOVSKI A.
AYDIN A.	17 (49') 24
	17 (49') 25 ATANASIJEVIKJ
PEHLIVAN O.	18 (50') 25
	18 (50') 26 PETKOVSKI A.
	18 (51') 27 ATANASIJEVIKJ
AYDIN A.	19 (52') 27
	19 (53') 28 PETROV K.
BILIM G.	20 (55') 28
AYDIN A.	21 (56') 28
BABACAN A.	22 (58') 28
	22 (58') 29 PETKOVSKI A.
	22 (59') 30 KOSTESKI N.
	22 (60') 31 GOGOV V.

#### LEGEND

%	Efficiency	(C)	Captain	2Min	2 minutes suspension	6m	6 metre Shots
7m	7 metre Shots	7mS	7metre Saves	9m	9 metre Shots	BC	Blue Cards
BT	Break Through Shots	FB	Fast Break Shots	G / S	Goals/Shots	No.	Uniform Number
RC	Red Cards	S	Saves	Wing	Wing Shots	YC	Yellow Card



SAT 2 JUL 2022

**Results**

Start Time 17:00

Game Duration: 01:28

**GRE 26 vs 28 TUR**

(14-11) (12-17)

Referees: Mohammed Amine FARSI (ALG) Boumediene KAHOUADJI (ALG)

**GRE - Greece**

No.	Name	Players		Shots						Punishment			
		G / S	%	6m	Wing	9m	7m	FB	BT	YC	2Min	RC	BC
2	STEFANITSIS Ioannis	4/5	80		2/3		2/2						
3	SINA Armando	3/4	75		3/4						1		
5	STATHIS Michail Nektarios												
6	PAGIATIS Eleftherios	2/2	100	1/1				1/1			1		
7	PAPAGIANNIS Christos												
8	TZORTZINIS Nikolaos (C)	2/4	50		2/3	0/1							
9	PAPAZOGLU Athanasios	3/6	50			3/6							
11	DIKAIOLIAS Nikolaos Marios	3/3	100	3/3							1		
12	BAMPATZANIDIS Dimitrios												
13	ALEXANDRIDIS Pantelis Leonidas	1/1	100			1/1					1		
15	TOSKAS Achilleas	3/4	75	1/1		2/3							
17	ANASTASIOU Eleftherios	2/5	40			2/5					2		
18	PANAGIOTOU Dimitrios	1/1	100			1/1							
21	GEROULANOS Andreas	2/5	40			2/5							
30	ASLIS Nikolaos												
<b>Bench/Team</b>													
<b>Totals</b>		26/40	65	5/5	7/10	11/22	2/2	1/1			6		

Goalkeepers		Saves							
No.	Name	S / S	%	6m	Wing	9m	7m	FB	BT
12	BAMPATZANIDIS Dimitrios	1/9	11	0/5	1/1	0/3			
30	ASLIS Nikolaos	6/26	23	1/8	0/4	3/10	1/1	1/3	
<b>Totals</b>		7/35	20	1/13	1/5	3/13	1/1	1/3	

**TUR - Turkiye**

No.	Name	Players		Shots						Punishment			
		G / S	%	6m	Wing	9m	7m	FB	BT	YC	2Min	RC	BC
8	TINKIR Durmus Ali	4/5	80	2/2		2/3					1		
9	ILANC Genco	0/1	0			0/1							
12	YATKIN Enis												
16	GOKTEPE Coskun												
17	BICER Gorkem	6/7	86	1/1	4/5			1/1			1		
24	OZTURK Halil Ibrahim (C)	2/5	40			2/5							
30	BABACAN Ali Emre	0/1	0			0/1							
32	KELESOGLU Ilkan	1/1	100	1/1									
33	ATES Yasar Erdem	2/2	100			1/1		1/1					
34	YAGMUROGLU Sevket												
52	AYDIN Alper									1	1		
53	KANBEROGLU Samet	0/2	0				0/1	0/1					
61	PEHLIVAN Omur	4/5	80	2/2		2/3							
70	DURMAZ Tolga	2/2	100	2/2								1	
77	BILIM Gokay												
78	SIRIN Atakan	7/9	78	4/5		3/3	0/1						
<b>Bench/Team</b>										1			
<b>Totals</b>		28/40	70	12/13	4/5	10/17	0/2	2/3		2	3	1	

Goalkeepers		Saves							
No.	Name	S / S	%	6m	Wing	9m	7m	FB	BT
12	YATKIN Enis	0/2	0			0/1	0/1		
16	GOKTEPE Coskun	10/34	29	0/5	2/9	8/18	0/1	0/1	
<b>Totals</b>		10/36	28	0/5	2/9	8/19	0/2	0/1	





SAT 2 JUL 2022

Start Time 17:00

Game Duration: 01:28

## Results

### RUNNING SCORE

1st Half		2nd Half	
PAGIATIS E.	1 (3') 0	14 (31') 12 BICER G.	
	1 (3') 1 PEHLIVAN O.	14 (32') 13 ATES Y.	
ANASTASIOU E.	2 (5') 1	GEROULANOS A.	15 (32') 13
GEROULANOS A.	3 (7') 1		15 (33') 14 TINKIR D.
	3 (8') 2 DURMAZ T.	ANASTASIOU E.	16 (33') 14
PAPAZOGLU A.	4 (8') 2		16 (34') 15 BICER G.
	4 (10') 3 SIRIN A.	TZORTZINIS N.	17 (35') 15
DIKAIOLIAS N.	5 (11') 3		17 (35') 16 SIRIN A.
	5 (11') 4 BICER G.		17 (36') 17 DURMAZ T.
	5 (12') 5 PEHLIVAN O.		17 (38') 18 BICER G.
TOSKAS A.	6 (14') 5		17 (40') 19 TINKIR D.
	6 (14') 6 SIRIN A.	TOSKAS A.	18 (40') 19
DIKAIOLIAS N.	7 (15') 6	ALEXANDRIDIS P.	19 (42') 19
	7 (16') 7 SIRIN A.	SINA A.	20 (45') 19
DIKAIOLIAS N.	8 (17') 7		20 (46') 20 ATES Y.
	8 (20') 8 SIRIN A.	STEFANITSIS I.	21 (47') 20
TZORTZINIS N.	9 (22') 8		21 (48') 21 PEHLIVAN O.
STEFANITSIS I.	10 (23') 8	TOSKAS A.	22 (49') 21
	10 (24') 9 TINKIR D.		22 (49') 22 BICER G.
SINA A.	11 (24') 9	STEFANITSIS I.	23 (50') 22
	11 (25') 10 TINKIR D.		23 (51') 23 SIRIN A.
	11 (26') 11 KELESOGLU I.		23 (52') 24 SIRIN A.
PANAGIOTOU D.	12 (27') 11	PAPAZOGLU A.	24 (53') 24
SINA A.	13 (28') 11		24 (53') 25 OZTURK H.
STEFANITSIS I.	14 (30') 11		24 (55') 26 OZTURK H.
		PAPAZOGLU A.	25 (57') 26
			25 (58') 27 BICER G.
		PAGIATIS E.	26 (60') 27
			26 (60') 28 PEHLIVAN O.

#### LEGEND

%	Efficiency	(C)	Captain	2Min	2 minutes suspension	6m	6 metre Shots
7m	7 metre Shots	7mS	7 metre Saves	9m	9 metre Shots	BC	Blue Cards
BT	Break Through Shots	FB	Fast Break Shots	G / S	Goals/Shots	No.	Uniform Number
RC	Red Cards	S	Saves	Wing	Wing Shots	YC	Yellow Card



SAT 2 JUL 2022

Results

Start Time 19:15

Game Duration: 01:21

ALG 19 vs 31 ESP  
(7-22) (12-9)

Referees: Marta SA (POR) Vania SA (POR)

ALG - Algeria

Players		Shots								Punishment			
No.	Name	G / S	%	6m	Wing	9m	7m	FB	BT	YC	2Min	RC	BC
2	NAIM Zohir	3/8	38	2/3	1/1	0/4							
3	CHEHBOUR Nabil	3/7	43	2/4		0/2		1/1					
4	HELLAL Nour-eddine										1		
6	BERKOUS Messaoud (C)												
9	MELAZEM Wail	3/9	33			3/9							
10	REMILI Hamza	2/2	100	2/2									
15	SAKER Redouane	4/4	100	1/1	1/1		2/2						
16	ZEMOUCHI Yahia A												
17	DJEDID Yacine	2/5	40	0/2	2/2	0/1							
18	KAABECHE Hichem	0/1	0			0/1					1		
22	GHEDBANE Khalifa												
26	KOURI Mokhtar	1/4	25	1/1		0/3							
36	RAHIM Abdelkader	1/2	50			1/2							
44	HADJ SADOK Moustafa	0/1	0			0/1							
77	ARIB Reda	0/2	0		0/1	0/1							
94	KHERMOUCHE Bastien Jean R	0/2	0	0/2							1		
<b>Bench/Team</b>													
<b>Totals</b>		19/47	40	8/15	4/5	4/24	2/2	1/1		1	2		

Goalkeepers		Saves							
No.	Name	S / S	%	6m	Wing	9m	7m	FB	BT
16	ZEMOUCHI Yahia A	0/3	0		0/1	0/1		0/1	
22	GHEDBANE Khalifa	15/43	35	4/14	2/5	5/12	1/5	3/7	
<b>Totals</b>		15/46	33	4/14	2/6	5/13	1/5	3/8	

ESP - Spain

Players		Shots								Punishment			
No.	Name	G / S	%	6m	Wing	9m	7m	FB	BT	YC	2Min	RC	BC
16	RODRIGUEZ LARIO Roberto												
18	GARCIANDIA ALUSTIZA Imanol	2/3	67			2/2		0/1					
23	BAZAN LEGASA Antonio	1/2	50	1/2									
31	VALERA ROVIRA Pol	1/4	25	1/2		0/2							
36	TARRAFETA SERRANO Ian	2/2	100	2/2									
49	MARTINEZ LOBATO Miquel	1/3	33		0/1	1/2							
55	IZQUIERDO LABAYEN Ander	2/4	50	1/2		1/2							
58	MARQUEZ COLOMA Jose Maria	5/9	56	3/4		2/5							
61	HERNANDEZ FERRER Sergey (C)												
62	ODRIOZOLA YEREGUI Kauldi	4/7	57		2/2		0/1	2/4					
63	FOLQUES ORTIZ Josep	2/2	100		1/1			1/1			2		
64	SERRANO VILLALOBOS Jorge	3/4	75		0/1		3/3						
70	FERNANDEZ JIMENEZ Daniel	4/5	80		1/2	1/1	1/1	1/1					
72	GALLEGO MURO Jaime	2/3	67	2/3									
73	NIETO MARCOS Asier	2/2	100			1/1		1/1					
74	MARTIN BOTET Alberto												
<b>Bench/Team</b>													
<b>Totals</b>		31/50	62	10/15	4/7	8/15	4/5	5/8			2		

Goalkeepers		Saves							
No.	Name	S / S	%	6m	Wing	9m	7m	FB	BT
16	RODRIGUEZ LARIO Roberto	1/6	17	0/1	0/3	1/1	0/1		
61	HERNANDEZ FERRER Sergey	15/29	52	5/12	1/2	9/13	0/1	0/1	
<b>Totals</b>		16/35	46	5/13	1/5	10/14	0/2	0/1	



SAT 2 JUL 2022

Start Time 19:15

Game Duration: 01:21

## Results

### RUNNING SCORE

#### ALG - ESP

1st Half		2nd Half	
0 (1')	1 NIETO A.	7 (31')	23 SERRANO J.
0 (3')	2 ODRIEZOLA K.	7 (33')	24 IZQUIERDO A.
0 (3')	3 FOLQUES J.	8 (33')	24 REMILI H.
0 (4')	4 TARRAFETA I.	8 (35')	25 MARTINEZ M.
0 (5')	5 NIETO A.	9 (35')	25 CHEHBOUR N.
0 (6')	6 GALLEGO J.	10 (38')	25 NAIM Z.
1 (7')	6 MELAZEM W.	10 (39')	26 GALLEGO J.
1 (8')	7 FOLQUES J.	11 (39')	26 CHEHBOUR N.
1 (8')	8 ODRIEZOLA K.	11 (39')	27 IZQUIERDO A.
1 (10')	9 GARCIAINDIA I.	12 (41')	27 NAIM Z.
2 (10')	9 MELAZEM W.	13 (44')	27 SAKER R.
2 (11')	10 GARCIAINDIA I.	13 (47')	28 TARRAFETA I.
2 (13')	11 ODRIEZOLA K.	14 (47')	28 REMILI H.
3 (16')	11 RAHIM A.	14 (48')	29 MARQUEZ J.
3 (17')	12 SERRANO J.	15 (50')	29 NAIM Z.
4 (18')	12 MELAZEM W.	16 (53')	29 SAKER R.
4 (19')	13 MARQUEZ J.	17 (56')	29 KOURI M.
4 (20')	14 FERNANDEZ D.	17 (56')	30 FERNANDEZ D.
4 (22')	15 BAZAN A.	18 (57')	30 DJEDID Y.
4 (23')	16 MARQUEZ J.	18 (58')	31 ODRIEZOLA K.
4 (25')	17 MARQUEZ J.	19 (58')	31 SAKER R.
4 (26')	18 VALERA P.		
5 (27')	18 SAKER R.		
5 (28')	19 SERRANO J.		
6 (28')	19 CHEHBOUR N.		
6 (29')	20 FERNANDEZ D.		
6 (29')	21 FERNANDEZ D.		
7 (30')	21 DJEDID Y.		
7 (30')	22 MARQUEZ J.		

#### LEGEND

%	Efficiency	(C)	Captain	2Min	2 minutes suspension	6m	6 metre Shots
7m	7 metre Shots	7mS	7 metre Saves	9m	9 metre Shots	BC	Blue Cards
BT	Break Through Shots	FB	Fast Break Shots	G / S	Goals/Shots	No.	Uniform Number
RC	Red Cards	S	Saves	Wing	Wing Shots	YC	Yellow Card



MON 4 JUL 2022

## Results

Start Time 13:00

Game Duration: 01:27

### EGY 34 vs 20 MKD (16-10) (18-10)

Referees: Mohamed GHOUARDA (ALG) Mustapha DECHE (ALG)

#### EGY - Egypt

Players		Shots								Punishment			
No.	Name	G / S	%	6m	Wing	9m	7m	FB	BT	YC	2Min	RC	BC
10	ABDOU Abdelrahman	1/3	33	0/1			0/1	1/1			1		
17	NASRALLA Ahmed	2/3	67	2/3									
21	ABOUSALEM Mohamed												
24	ELMASRY Ibrahim	1/1	100	1/1							2		
31	ELWAKIL Omar	3/4	75		1/2			2/2					
39	ELDERAA Yehia	1/2	50	0/1		1/1							
42	KADDAH Hassan	3/4	75	2/3		1/1					1		
45	ELDERAA Seif	3/3	100	1/1				2/2					
48	ABDELHAK Mohab	1/3	33	1/1		0/2							
53	SAAD Akram	3/5	60		1/3		1/1	1/1					
66	ELAHMAR Ahmed (C)	4/8	50	3/3	0/1	0/2	1/2						
80	MESILHY Ahmed	4/8	50	4/8									
88	HENDAWY Karim												
90	MOHAMED Ali									1			
91	SANAD Mohammd	8/11	73	2/2	2/3		1/3	3/3					
96	ELTAYAR Mohamed												
<b>Bench/Team Totals</b>		34/55	62	16/24	4/9	2/6	3/7	9/9		1	4		

Goalkeepers		Saves							
No.	Name	S / S	%	6m	Wing	9m	7m	FB	BT
88	HENDAWY Karim	9/19	47	4/11	2/4	3/3		0/1	
96	ELTAYAR Mohamed	4/14	29	1/6	0/2	2/5	1/1		
<b>Totals</b>		13/33	39	5/17	2/6	5/8	1/1	0/1	

#### MKD - North Macedonia

Players		Shots								Punishment			
No.	Name	G / S	%	6m	Wing	9m	7m	FB	BT	YC	2Min	RC	BC
8	DJONOV Ivan	3/4	75	2/2	1/1	0/1					1		
9	GJORGIEV Igor	1/5	20			1/5							
10	MITEV Marko									1			
19	KOSTESKI Nenad	2/2	100		2/2						1		
20	KIZIKJ Marko												
21	PETKOVSKI Aleksandar	1/4	25		1/3		0/1						
23	IVANOSKI Mihail												
31	MLADENOVIKJ Mihajlo	1/1	100			1/1							
34	JAGURINOSKI Tomislav	3/5	60	2/2		1/3				1			
42	STOJKOVIKJ Marko	3/4	75	3/4							1		
55	ATANASIJEVIKJ Petar	1/2	50	0/1				1/1					
77	SERAFIMOV Martin	0/3	0			0/2	0/1						
88	SIMONOSKI Kristijan	0/2	0	0/2									
89	ATANASIJEVIKJ Pavle	3/5	60	3/3		0/2					1		
92	PETROV Kostadin (C)	2/4	50	2/3		0/1							
98	GGOV Vasil												
<b>Bench/Team Totals</b>		20/41	49	12/17	4/6	3/15	0/2	1/1		1	4		

Goalkeepers		Saves							
No.	Name	S / S	%	6m	Wing	9m	7m	FB	BT
20	KIZIKJ Marko	11/34	32	5/15	3/5	2/3	1/3	0/8	
98	GGOV Vasil	7/18	39	2/8	1/3	1/2	3/4	0/1	
<b>Totals</b>		18/52	35	7/23	4/8	3/5	4/7	0/9	



MON 4 JUL 2022

## Results

Start Time 13:00

Game Duration: 01:27

### RUNNING SCORE

#### EGY - MKD

1st Half		2nd Half	
NASRALLA A.	1 (4') 0	16 (31') 11	ATANASIJEVIKJ
SAAD A.	2 (5') 0	SANAD M.	17 (32') 11
	2 (5') 1	MESILHY A.	18 (33') 11
	STOJKOVIKJ M.		18 (34') 12
ELMASRY I.	3 (5') 1	ELWAKIL O.	19 (34') 12
MESILHY A.	4 (7') 1	SANAD M.	20 (36') 12
	4 (8') 2	SANAD M.	21 (38') 12
	MLADENOVIKJ M.	SANAD M.	22 (39') 12
SAAD A.	5 (9') 2		22 (40') 13
	5 (10') 3		PETKOVSKI A.
ELAHMAR A.	6 (12') 3	MESILHY A.	23 (41') 13
	6 (15') 4		23 (41') 14
	JAGURINOSKI T.		STOJKOVIKJ M.
	6 (16') 5	ELDERAA Y.	24 (41') 14
	KOSTESKI N.		24 (42') 15
ELAHMAR A.	7 (17') 5		DJONOV I.
	7 (18') 6		24 (44') 16
	PETROV K.	SANAD M.	25 (45') 16
ELAHMAR A.	8 (18') 6		25 (46') 17
KADDAH H.	9 (21') 6	ABDELHAK M.	26 (46') 17
	9 (21') 7		27 (47') 17
	DJONOV I.	SANAD M.	27 (48') 18
ELAHMAR A.	10 (22') 7		27 (49') 19
ELWAKIL O.	11 (23') 7		ATANASIJEVIKJ
	11 (23') 8		27 (49') 19
	KOSTESKI N.	MESILHY A.	28 (50') 19
	DJONOV I.	KADDAH H.	29 (52') 19
SAAD A.	12 (26') 9		30 (54') 19
ELDERAA S.	13 (27') 9		31 (54') 19
ELWAKIL O.	14 (27') 9		32 (57') 19
ELDERAA S.	15 (29') 9		32 (58') 20
ELDERAA S.	16 (29') 9		JAGURINOSKI T.
	16 (29') 10	NASRALLA A.	33 (59') 20
	PETROV K.	ABDOU A.	34 (60') 20

#### LEGEND

%	Efficiency	(C)	Captain	2Min	2 minutes suspension	6m	6 metre Shots
7m	7 metre Shots	7mS	7 metre Saves	9m	9 metre Shots	BC	Blue Cards
BT	Break Through Shots	FB	Fast Break Shots	G / S	Goals/Shots	No.	Uniform Number
RC	Red Cards	S	Saves	Wing	Wing Shots	YC	Yellow Card



MON 4 JUL 2022

## Results

Start Time 18:00

Game Duration: 01:25

### ESP 42 vs 38 SRB (22-21) (20-17)

Referees: Youcef BELKHIRI (ALG) Sid Ali HAMIDI (ALG)

#### ESP - Spain

No.	Name	Players		Shots						Punishment			
		G / S	%	6m	Wing	9m	7m	FB	BT	YC	2Min	RC	BC
16	RODRIGUEZ LARIO Roberto												
18	GARCIANDIA ALUSTIZA Imanol	4/7	57	2/2		2/5							
23	BAZAN LEGASA Antonio	3/3	100	3/3									
31	VALERA ROVIRA Pol	1/1	100			1/1							
36	TARRAFETA SERRANO Ian	4/7	57	2/4	0/1	2/2							
49	MARTINEZ LOBATO Miquel												
55	IZQUIERDO LABAYEN Ander												
58	MARQUEZ COLOMA Jose Maria	6/6	100	2/2	1/1	3/3							
61	HERNANDEZ FERRER Sergey (C)												
62	ODRIOZOLA YEREGUI Kauldi	6/9	67		3/4		2/4	1/1					
63	FOLQUES ORTIZ Josep	3/3	100	2/2	1/1					1			
64	SERRANO VILLALOBOS Jorge	5/8	63	1/1		0/1	1/3	3/3					
70	FERNANDEZ JIMENEZ Daniel	6/7	86	0/1	2/2			4/4					
72	GALLEGO MURO Jaime	1/2	50	1/2									
73	NIETO MARCOS Asier	3/5	60	1/1	0/1	2/2	0/1			1			
74	MARTIN BOTET Alberto												
<b>Bench/Team</b>													
<b>Totals</b>		42/58	72	14/18	7/10	10/14	3/8	8/8		1	1		

Goalkeepers		Saves							
No.	Name	S / S	%	6m	Wing	9m	7m	FB	BT
16	RODRIGUEZ LARIO Roberto	2/7	29	1/3		1/4			
61	HERNANDEZ FERRER Sergey	10/43	23	2/15	1/8	7/17	0/2	0/1	
<b>Totals</b>		12/50	24	3/18	1/8	8/21	0/2	0/1	

#### SRB - Serbia

No.	Name	Players		Shots						Punishment			
		G / S	%	6m	Wing	9m	7m	FB	BT	YC	2Min	RC	BC
1	BOMASTAR Milan	0/1	0			0/1							
3	VORKAPIC Vukasin	3/3	100	1/1	1/1			1/1			1		
5	MILIC Milan	7/13	54	4/5		3/8				1	1		
6	BORZAS Uros	7/11	64	2/2	0/1	5/8				1			
12	JANDRIC Todor												
16	TRNAVAC Andrej												
17	KOJADINOVIC Uros	2/2	100		1/1	1/1					1		
18	PAVLOVIC Uros	0/2	0	0/2							1		
20	GOLUBOVIC Milan												
23	POPOVIC Veljko	3/3	100	2/2		1/1							
24	VIGNJEVIC Marko	0/1	0			0/1							
28	SOTIC Mladen (C)												
33	PETRIC Stefan												
34	POPOVIC Ivan	4/6	67	3/5		1/1					1		
39	MILOSAVLJEVIC Marko	5/9	56	2/2	1/1	2/6							
69	GROZDANIC Milos	7/8	88	1/1	4/5		2/2						
<b>Bench/Team</b>													
<b>Totals</b>		38/59	64	15/20	7/9	13/27	2/2	1/1		2	5		

Goalkeepers		Saves							
No.	Name	S / S	%	6m	Wing	9m	7m	FB	BT
1	BOMASTAR Milan	12/45	27	4/14	3/9	3/12	2/5	0/5	
12	JANDRIC Todor	2/11	18	0/4	0/1	0/1	2/2	0/3	
<b>Totals</b>		14/56	25	4/18	3/10	3/13	4/7	0/8	



MON 4 JUL 2022

## Results

Start Time 18:00

Game Duration: 01:25

### RUNNING SCORE

#### ESP - SRB

1st Half		2nd Half	
GARCIANDIA I.	1 (1') 0	VALERA P.	23 (33') 21
	1 (1') 1 GROZDANIC M.		23 (33') 22 MILIC M.
FOLQUES J.	2 (2') 1		23 (34') 23 MILIC M.
FOLQUES J.	3 (2') 1	MARQUEZ J.	24 (34') 23
	3 (3') 2 BORZAS U.	FERNANDEZ D.	25 (35') 23
ODRIOZOLA K.	4 (3') 2	SERRANO J.	26 (35') 23
	4 (3') 3 MILOSAVLJEVIC		26 (36') 24 POPOVIC I.
ODRIOZOLA K.	5 (4') 3	SERRANO J.	27 (36') 24
	5 (5') 4 GROZDANIC M.		27 (38') 25 VORKAPIC V.
	5 (6') 5 VORKAPIC V.	BAZAN A.	28 (39') 25
TARRAFETA I.	6 (6') 5		28 (40') 26 MILOSAVLJEVIC
ODRIOZOLA K.	7 (7') 5		28 (42') 27 MILOSAVLJEVIC
	7 (8') 6 VORKAPIC V.	SERRANO J.	29 (42') 27
GARCIANDIA I.	8 (8') 6		29 (42') 28 BORZAS U.
	8 (9') 7 GROZDANIC M.	FERNANDEZ D.	30 (43') 28
	8 (11') 8 POPOVIC I.	MARQUEZ J.	31 (44') 28
NIETO A.	9 (11') 8		31 (46') 29 BORZAS U.
	9 (11') 9 BORZAS U.	MARQUEZ J.	32 (46') 29
FERNANDEZ D.	10 (12') 9		32 (47') 30 MILIC M.
	10 (13') 10 MILOSAVLJEVIC		32 (48') 31 KOJADINOVIC U.
TARRAFETA I.	11 (13') 10	MARQUEZ J.	33 (48') 31
	11 (13') 11 MILIC M.	SERRANO J.	34 (49') 31
ODRIOZOLA K.	12 (16') 11	SERRANO J.	35 (50') 31
	12 (17') 12 BORZAS U.	FERNANDEZ D.	36 (50') 31
	12 (18') 13 POPOVIC I.		36 (51') 32 GROZDANIC M.
	12 (19') 14 POPOVIC I.	TARRAFETA I.	37 (51') 32
ODRIOZOLA K.	13 (20') 14		37 (56') 33 MILOSAVLJEVIC
NIETO A.	14 (21') 14		37 (56') 34 MILIC M.
	14 (22') 15 POPOVIC V.	GALLEGO J.	38 (56') 34
	14 (23') 16 KOJADINOVIC U.		38 (57') 35 GROZDANIC M.
MARQUEZ J.	15 (24') 16	TARRAFETA I.	39 (57') 35
	15 (25') 17 MILIC M.		39 (58') 36 BORZAS U.
NIETO A.	16 (26') 17	ODRIOZOLA K.	40 (58') 36
	16 (26') 18 MILIC M.		40 (59') 37 POPOVIC V.
GARCIANDIA I.	17 (27') 18	FOLQUES J.	41 (59') 37
	17 (27') 19 POPOVIC V.	GARCIANDIA I.	42 (60') 37
BAZAN A.	18 (28') 19		42 (60') 38 BORZAS U.
FERNANDEZ D.	19 (28') 19		
	19 (29') 20 GROZDANIC M.		
BAZAN A.	20 (29') 20		
FERNANDEZ D.	21 (30') 20		
	21 (30') 21 GROZDANIC M.		
MARQUEZ J.	22 (30') 21		



MON 4 JUL 2022

## Results

Start Time 18:00

Game Duration: 01:25

## ESP 42 vs 38 SRB

(22-21) (20-17)

Referees: Youcef BELKHIRI (ALG) Sid Ali HAMIDI (ALG)

## LEGEND

%	Efficiency	(C)	Captain	2Min	2 minutes suspension	6m	6 metre Shots
7m	7 metre Shots	7mS	7 metre Saves	9m	9 metre Shots	BC	Blue Cards
BT	Break Through Shots	FB	Fast Break Shots	G / S	Goals/Shots	No.	Uniform Number
RC	Red Cards	S	Saves	Wing	Wing Shots	YC	Yellow Card





WED 6 JUL 2022

## Results

Start Time 16:30

Game Duration: 01:28

### EGY 27 vs 28 ESP

(16-13) (11-15)

Referees: Youcef BELKHIRI (ALG) Sid Ali HAMIDI (ALG)

## EGY - Egypt

No.	Name	Players		Shots						Punishment				
		G / S	%	6m	Wing	9m	7m	FB	BT	YC	2Min	RC	BC	
10	ABDOU Abdelrahman													
17	NASRALLA Ahmed													
24	ELMASRY Ibrahim	1/1	100	1/1										
31	ELWAKIL Omar	2/2	100		2/2						1			
39	ELDERAA Yehia	4/6	67	3/3		1/3								
42	KADDAH Hassan	2/5	40	1/1		1/4								
45	ELDERAA Seif	1/3	33			0/2		1/1						
48	ABDELHAK Mohab	1/3	33			1/3					1			
53	SAAD Akram													
66	ELAHMAR Ahmed (C)	1/2	50			1/2								
80	MESILHY Ahmed	4/5	80	4/5										
88	HENDAWY Karim	1/1	100					1/1						
90	MOHAMED Ali	2/3	67			2/3								
91	SANAD Mohammd	7/10	70		1/3		5/6	1/1			1			
96	ELTAYAR Mohamed													
Bench/Team		1/1	100					1/1						
Totals		27/42	64	9/10	3/5	6/17	5/6	4/4			3			

Goalkeepers		Saves							
No.	Name	S / S	%	6m	Wing	9m	7m	FB	BT
88	HENDAWY Karim	5/33	15	1/15	1/3	3/11		0/4	
96	ELTAYAR Mohamed								
Totals		5/33	15	1/15	1/3	3/11		0/4	

## ESP - Spain

No.	Name	Players		Shots						Punishment				
		G / S	%	6m	Wing	9m	7m	FB	BT	YC	2Min	RC	BC	
16	RODRIGUEZ LARIO Roberto													
18	GARCIANDIA ALUSTIZA Imanol	4/9	44	1/2		2/6		1/1						
23	BAZAN LEGASA Antonio										1			
31	VALERA ROVIRA Pol	1/2	50			1/2								
36	TARRAFETA SERRANO Ian	10/11	91	6/6		4/5								
49	MARTINEZ LOBATO Miquel	1/1	100	1/1							1			
55	IZQUIERDO LABAYEN Ander													
58	MARQUEZ COLOMA Jose Maria	2/3	67	2/2		0/1								
61	HERNANDEZ FERRER Sergey (C)													
62	ODRIOZOLA YEREGUI Kauldi	2/4	50	1/1	0/2			1/1						
63	FOLQUES ORTIZ Josep	3/4	75	1/1	0/1			2/2						
64	SERRANO VILLALOBOS Jorge	2/2	100		2/2									
70	FERNANDEZ JIMENEZ Daniel											1		
72	GALLEGO MURO Jaime	2/3	67	2/3							1	2		
73	NIETO MARCOS Asier	1/1	100			1/1								
74	MARTIN BOTET Alberto													
Bench/Team														
Totals		28/40	70	14/16	2/5	8/15		4/4			1	5		

Goalkeepers		Saves							
No.	Name	S / S	%	6m	Wing	9m	7m	FB	BT
16	RODRIGUEZ LARIO Roberto								
61	HERNANDEZ FERRER Sergey	11/38	29	1/10	2/5	7/13	1/6	0/4	
Totals		11/38	29	1/10	2/5	7/13	1/6	0/4	



WED 6 JUL 2022

## Results

Start Time 16:30

Game Duration: 01:28

### RUNNING SCORE

#### EGY - ESP

1st Half		2nd Half	
0 (1')	1 FOLQUES J.	ELAHMAR A.	17 (31') 13
0 (3')	2 TARRAFETA I.	ELDERAA S.	18 (32') 13
KADDAH H.	1 (3') 2		18 (32') 14 GARCIAINDIA I.
	1 (3') 3 ODRIOZOLA K.	SANAD M.	19 (33') 14
	1 (6') 4 FOLQUES J.		19 (34') 15 SERRANO J.
ELWAKIL O.	2 (7') 4		19 (35') 16 MARQUEZ J.
	2 (8') 5 NIETO A.		19 (36') 17 GARCIAINDIA I.
ELMASRY I.	3 (8') 5		19 (36') 18 FOLQUES J.
	3 (9') 6 ODRIOZOLA K.	SANAD M.	20 (39') 18
MOHAMED A.	4 (9') 6	ELDERAA Y.	21 (39') 18
ELDERAA Y.	5 (10') 6		21 (40') 19 TARRAFETA I.
	5 (11') 7 TARRAFETA I.		21 (42') 20 TARRAFETA I.
ELWAKIL O.	6 (14') 7	MESILHY A.	22 (42') 20
MOHAMED A.	7 (15') 7	MESILHY A.	23 (43') 20
MESILHY A.	8 (16') 7		23 (44') 21 TARRAFETA I.
SANAD M.	9 (18') 7		23 (45') 22 TARRAFETA I.
MESILHY A.	10 (20') 7		23 (47') 23 GARCIAINDIA I.
	10 (23') 8 TARRAFETA I.	ELDERAA Y.	24 (50') 23
SANAD M.	11 (24') 8		25 (52') 24 TARRAFETA I.
SANAD M.	12 (24') 8	KADDAH H.	26 (52') 24
	12 (24') 9 MARTINEZ M.		26 (53') 25 VALERA P.
SANAD M.	13 (25') 9	ELDERAA Y.	27 (54') 25
	13 (26') 10 MARQUEZ J.		27 (55') 26 TARRAFETA I.
SANAD M.	14 (26') 10		27 (57') 27 TARRAFETA I.
HENDAWY K.	15 (27') 10		27 (60') 28 GARCIAINDIA I.
	15 (28') 11 GALLEGO J.		
	15 (29') 12 GALLEGO J.		
	15 (30') 13 SERRANO J.		
ABDELHAK M.	16 (30') 13		

#### LEGEND

%	Efficiency	(C)	Captain	2Min	2 minutes suspension	6m	6 metre Shots
7m	7 metre Shots	7mS	7 metre Saves	9m	9 metre Shots	BC	Blue Cards
BT	Break Through Shots	FB	Fast Break Shots	G / S	Goals/Shots	No.	Uniform Number
RC	Red Cards	S	Saves	Wing	Wing Shots	YC	Yellow Card



WED 6 JUL 2022

## Results

Start Time 11:30

Game Duration: 01:30

### MKD 29 vs 34 SRB

(13-15) (16-19)

Referees: Mustapha DECHE (ALG) Mohamed GHOUARDA (ALG)

#### MKD - North Macedonia

No.	Name	Players				Shots					Punishment			
		G / S	%	6m	Wing	9m	7m	FB	BT	YC	2Min	RC	BC	
8	DJONOV Ivan	2/5	40	1/3		0/1		1/1						
9	GJORGIEV Igor	2/5	40	2/3		0/1		0/1			1			
10	MITEV Marko										1			
19	KOSTESKI Nenad	2/3	67		1/2			1/1						
20	KIZIKJ Marko													
21	PETKOVSKI Aleksandar	3/5	60		1/2		2/3							
23	IVANOSKI Mihail													
31	MLADENOVIKJ Mihajlo										1			
34	JAGURINOSKI Tomislav	3/7	43	2/3		1/4					1			
42	STOJKOVIKJ Marko	3/3	100	2/2				1/1						
55	ATANASIJEVIKJ Petar	5/7	71		5/7									
77	SERAFIMOV Martin	3/8	38	0/1		2/5	1/2				1			
88	SIMONOSKI Kristijan													
89	ATANASIJEVIKJ Pavle	1/3	33	0/1		1/2					2			
92	PETROV Kostadin (C)	5/6	83	5/6										
98	GOGOVS Vasil													
<b>Bench/Team</b>														
<b>Totals</b>		29/52	56	12/19	7/11	4/13	3/5	3/4			7			

Goalkeepers		Saves							
No.	Name	S / S	%	6m	Wing	9m	7m	FB	BT
20	KIZIKJ Marko	3/23	13	1/8	0/3	1/8	1/3	0/1	
98	GOGOVS Vasil	5/19	26	3/8	1/4	1/5	0/2		
<b>Totals</b>		8/42	19	4/16	1/7	2/13	1/5	0/1	

#### SRB - Serbia

No.	Name	Players				Shots					Punishment			
		G / S	%	6m	Wing	9m	7m	FB	BT	YC	2Min	RC	BC	
1	BOMASTAR Milan													
3	VORKAPIC Vukasin	6/6	100	1/1	5/5						2			
5	MILIC Milan	4/6	67	1/1		3/5					1			
6	BORZAS Uros	4/7	57	2/2		2/5					1			
12	JANDRIC Todor													
16	TRNAVAC Andrej													
17	KOJADINOVIC Uros	3/4	75	1/1		2/3								
18	PAVLOVIC Uros										2			
20	GOLUBOVIC Milan										1			
23	POPOVIC Veljko	3/4	75	3/4							1			
24	VIGNJEVIC Marko	2/2	100	1/1				1/1			2			
28	SOTIC Mladen (C)													
33	PETRIC Stefan													
34	POPOVIC Ivan	2/4	50	2/4						1	3			
39	MILOSAVLJEVIC Marko	5/8	63	1/3		4/5								
69	GROZDANIC Milos	5/7	71		1/2		4/5							
<b>Bench/Team</b>														
<b>Totals</b>		34/48	71	12/17	6/7	11/18	4/5	1/1		1	13			

Goalkeepers		Saves							
No.	Name	S / S	%	6m	Wing	9m	7m	FB	BT
1	BOMASTAR Milan								
12	JANDRIC Todor	12/41	29	3/15	3/10	4/8	1/4	1/4	
<b>Totals</b>		12/41	29	3/15	3/10	4/8	1/4	1/4	



WED 6 JUL 2022

Start Time 11:30

Game Duration: 01:30

## Results

### RUNNING SCORE

#### MKD - SRB

1st Half		2nd Half	
	<b>0 (1') 1</b> MILOSAVLJEVIC		<b>14 (31') 15</b> PETROV K.
JAGURINOSKI T.	<b>1 (2') 1</b>		<b>14 (32') 16</b> VORKAPIC V.
	<b>1 (2') 2</b> VORKAPIC V.	SERAFIMOV M.	<b>15 (32') 16</b>
STOJKOVIKJ M.	<b>2 (2') 2</b>		<b>15 (33') 17</b> MILIC M.
	<b>2 (3') 3</b> POPOVIC I.	STOJKOVIKJ M.	<b>16 (33') 17</b>
PETKOVSKI A.	<b>3 (4') 3</b>		<b>16 (33') 18</b> GROZDANIC M.
	<b>3 (5') 4</b> VORKAPIC V.	ATANASIJEVIKJ	<b>17 (34') 18</b>
JAGURINOSKI T.	<b>4 (5') 4</b>		<b>17 (35') 19</b> VIGNJEVIC M.
PETKOVSKI A.	<b>5 (7') 4</b>		<b>17 (37') 20</b> VORKAPIC V.
KOSTESKI N.	<b>6 (8') 4</b>	ATANASIJEVIKJ	<b>18 (38') 20</b>
	<b>6 (9') 5</b> BORZAS U.		<b>18 (39') 21</b> MILIC M.
PETROV K.	<b>7 (12') 5</b>		<b>18 (40') 22</b> MILOSAVLJEVIC
ATANASIJEVIKJ	<b>8 (13') 5</b>	GJORGIEV I.	<b>19 (40') 22</b>
	<b>8 (14') 6</b> GROZDANIC M.		<b>19 (41') 23</b> BORZAS U.
SERAFIMOV M.	<b>9 (14') 6</b>		<b>19 (42') 24</b> KOJADINOVIC U.
	<b>9 (18') 7</b> POPOVIC I.	JAGURINOSKI T.	<b>20 (43') 24</b>
PETROV K.	<b>10 (19') 7</b>		<b>20 (43') 25</b> VIGNJEVIC M.
	<b>10 (20') 8</b> GROZDANIC M.	PETROV K.	<b>21 (44') 25</b>
	<b>10 (21') 9</b> BORZAS U.		<b>21 (45') 26</b> GROZDANIC M.
	<b>10 (22') 10</b> BORZAS U.	GJORGIEV I.	<b>22 (46') 26</b>
PETKOVSKI A.	<b>11 (23') 10</b>		<b>22 (47') 27</b> KOJADINOVIC U.
	<b>11 (24') 11</b> VORKAPIC V.		<b>22 (48') 28</b> VORKAPIC V.
	<b>11 (25') 12</b> GROZDANIC M.	PETROV K.	<b>23 (48') 28</b>
DJONOV I.	<b>12 (25') 12</b>		<b>23 (49') 29</b> POPOVIC V.
	<b>12 (26') 13</b> POPOVIC V.		<b>23 (50') 30</b> POPOVIC V.
DJONOV I.	<b>13 (27') 13</b>	ATANASIJEVIKJ	<b>24 (51') 30</b>
	<b>13 (28') 14</b> MILIC M.	SERAFIMOV M.	<b>25 (52') 30</b>
	<b>13 (29') 15</b> MILIC M.	KOSTESKI N.	<b>26 (54') 30</b>
			<b>26 (56') 31</b> KOJADINOVIC U.
			<b>26 (57') 32</b> MILOSAVLJEVIC
		ATANASIJEVIKJ	<b>27 (57') 32</b>
			<b>27 (57') 33</b> MILOSAVLJEVIC
		STOJKOVIKJ M.	<b>28 (58') 33</b>
			<b>28 (58') 34</b> MILOSAVLJEVIC
		ATANASIJEVIKJ	<b>29 (60') 34</b>

#### LEGEND

%	Efficiency	(C)	Captain	2Min	2 minutes suspension	6m	6 metre Shots
7m	7 metre Shots	7mS	7 metre Saves	9m	9 metre Shots	BC	Blue Cards
BT	Break Through Shots	FB	Fast Break Shots	G / S	Goals/Shots	No.	Uniform Number
RC	Red Cards	S	Saves	Wing	Wing Shots	YC	Yellow Card



MON 4 JUL 2022

## Results

Start Time 15:00

Game Duration: 02:12

### TUN 39 vs 35 ALG (13-12) (13-14) (5-5) 8-4

Referees: Metodija ILIEVSKI (MKD) Mihajlo ILIEVSKI (MKD)

#### TUN - Tunisia

Players		Shots								Punishment			
No.	Name	G / S	%	6m	Wing	9m	7m	FB	BT	YC	2Min	RC	BC
9	BANNOUR Amine (C)	3/5	60	1/2		2/3							
10	ABDELLI Bilel	1/5	20	1/3		0/2							
13	BHAR Mohamed Ali	1/2	50	1/1				0/1					
21	BOUGHANMI Oussama	8/10	80	2/2	1/1	1/2	3/4	1/1			1		
22	MAAREF Yousef	1/2	50		0/1	1/1					1		
27	RZIG Issam	4/4	100	1/1	1/1			2/2			1		
28	BACHA Hazem	3/4	75	2/2		0/1		1/1					
45	MUSTAPHA Ala	1/2	50	1/2							1		
55	TOUMI Ghassen												
57	MAOUA Noureddine												
61	BELKAIED Yassine												
69	JABALLAH Jihed	3/3	100	2/2	1/1								
71	DARMOUL Mohamed Amine	7/7	100	4/4	1/1	2/2							
90	CHOUJREF Marouan	4/5	80	3/3		0/1		1/1			1		
92	JAZIRI Oussama	3/6	50	1/2		2/4					1		
<b>Bench/Team</b>													
<b>Totals</b>		39/55	71	19/24	4/5	8/16	3/4	5/6			6		

Goalkeepers		Saves							
No.	Name	S / S	%	6m	Wing	9m	7m	FB	BT
10	ABDELLI Bilel								
27	RZIG Issam								
61	BELKAIED Yassine	0/5	0	0/1	0/1		0/2	0/1	
<b>Totals</b>		0/5	0	0/1	0/1		0/2	0/1	

#### ALG - Algeria

Players		Shots								Punishment			
No.	Name	G / S	%	6m	Wing	9m	7m	FB	BT	YC	2Min	RC	BC
2	NAIM Zohir	10/11	91	8/8	1/1	0/1		1/1			1		
3	CHEHBOUR Nabil	0/5	0	0/3		0/2					1		
4	HELLAL Nour-eddine	3/4	75	1/2		1/1		1/1					
6	BERKOUS Messaoud (C)												
9	MELAZEM Wail												
10	REMILI Hamza	2/4	50	1/2		1/2							
15	SAKER Redouane												
16	ZEMOUCHI Yahia A												
17	DJEDID Yacine	3/5	60	0/2			3/3						
18	KAABECHE Hichem												
22	GHEDBANE Khalifa												
26	KOURI Mokhtar	3/6	50	3/5		0/1					1		
36	RAHIM Abdelkader												
44	HADJ SADOK Moustafa	5/12	42	3/7		2/4	0/1				1		
77	ARIB Reda	8/11	73	4/6	2/2		0/1	2/2			1		
94	KHERMOUCHE Bastien Jean R	1/2	50	1/2							1		
<b>Bench/Team</b>													
<b>Totals</b>		35/60	58	21/37	3/3	4/11	3/5	4/4			6		

Goalkeepers		Saves							
No.	Name	S / S	%	6m	Wing	9m	7m	FB	BT
16	ZEMOUCHI Yahia A	6/31	19	2/13	1/5	2/7	1/3	0/3	
22	GHEDBANE Khalifa	5/18	28	3/10		2/5	0/1	0/2	
44	HADJ SADOK Moustafa								
<b>Totals</b>		11/49	22	5/23	1/5	4/12	1/4	0/5	



MON 4 JUL 2022

## Results

Start Time 15:00

Game Duration: 02:12

### RUNNING SCORE

#### TUN - ALG

1st Half	2nd Half	1st Extra Time
0 (4') 1 HADJ SADOK M.	BOUGHANMI O. 14 (31') 12	DARMOUL M. 27 (61') 26
0 (4') 2 HELLAL N.	14 (31') 13 REMILI H.	27 (62') 27 KOURI M.
BHAR M. 1 (4') 2	14 (32') 14 NAIM Z.	27 (63') 28 NAIM Z.
BACHA H. 2 (5') 2	14 (33') 15 KOURI M.	DARMOUL M. 28 (64') 28
2 (7') 3 ARIB R.	CHOUIREF M. 15 (34') 15	28 (65') 29 HADJ SADOK M.
CHOUIREF M. 3 (7') 3	15 (34') 16 NAIM Z.	DARMOUL M. 29 (65') 29
3 (7') 4 NAIM Z.	MUSTAPHA A. 16 (35') 16	RZIG I. 30 (66') 29
3 (9') 5 HADJ SADOK M.	BOUGHANMI O. 17 (39') 16	30 (67') 30 NAIM Z.
BACHA H. 4 (9') 5	JAZIRI O. 18 (41') 16	RZIG I. 31 (67') 30
4 (10') 6 NAIM Z.	JAZIRI O. 19 (42') 16	31 (70') 31 DJEDID Y.
CHOUIREF M. 5 (10') 6	19 (44') 17 HELLAL N.	2nd Extra Time
BACHA H. 6 (11') 6	19 (44') 18 ARIB R.	MAAREF Y. 32 (72') 31
6 (15') 7 ARIB R.	19 (45') 19 KOURI M.	DARMOUL M. 33 (73') 31
CHOUIREF M. 7 (17') 7	BOUGHANMI O. 20 (47') 19	33 (75') 32 NAIM Z.
7 (21') 8 KHERMOUCHE B.	BOUGHANMI O. 21 (49') 19	DARMOUL M. 34 (75') 32
7 (22') 9 ARIB R.	21 (51') 20 ARIB R.	RZIG I. 35 (76') 32
BANNOUR A. 8 (22') 9	DARMOUL M. 22 (53') 20	35 (76') 33 DJEDID Y.
8 (22') 10 NAIM Z.	22 (53') 21 ARIB R.	JABALLAH J. 36 (77') 33
8 (25') 11 NAIM Z.	BOUGHANMI O. 23 (54') 21	ABDELLI B. 37 (78') 33
JAZIRI O. 9 (25') 11	23 (55') 22 HADJ SADOK M.	37 (78') 34 ARIB R.
BANNOUR A. 10 (26') 11	BANNOUR A. 24 (56') 22	JABALLAH J. 38 (79') 34
10 (27') 12 REMILI H.	24 (56') 23 HADJ SADOK M.	38 (79') 35 NAIM Z.
BOUGHANMI O. 11 (27') 12	DARMOUL M. 25 (56') 23	JABALLAH J. 39 (80') 35
BOUGHANMI O. 12 (29') 12	RZIG I. 26 (57') 23	
BOUGHANMI O. 13 (30') 12	26 (57') 24 ARIB R.	
	26 (59') 25 HELLAL N.	
	26 (60') 26 DJEDID Y.	

#### LEGEND

%	Efficiency	(C)	Captain	2Min	2 minutes suspension	6m	6 metre Shots
7m	7 metre Shots	7mS	7 metre Saves	9m	9 metre Shots	BC	Blue Cards
BT	Break Through Shots	FB	Fast Break Shots	G / S	Goals/Shots	No.	Uniform Number
RC	Red Cards	S	Saves	Wing	Wing Shots	YC	Yellow Card



MON 4 JUL 2022

**Results**

Start Time 12:30

Game Duration: 01:24

**ITA 34 vs 25 TUR**

(22-11) (12-14)

Referees: Dragana JAKOVLJEVIC (SRB) Danijela SANDO KOVACEVIC (SRB)

**ITA - Italy**

No.	Name	Players		Shots						Punishment				
		G / S	%	6m	Wing	9m	7m	FB	BT	YC	2Min	RC	BC	
1	VOLAREVIC Mate													
2	MORETTI Alessio	6/7	86	0/1		1/1	5/5							
4	PRANTNER Leo	3/4	75	2/2	1/2									
5	DAPIRAN Gianluca	2/3	67		0/1			1/1	1/1					
6	BULZAMINI Davide	4/5	80	1/1		2/3		1/1						
8	SAVINI Giacomo	2/3	67	1/2		1/1								
10	MENGON Marco	6/8	75	3/3		1/3		2/2						
11	D'ANTINO Nicolo'	1/2	50	1/1	0/1									
12	COLLELUORI Andrea													
14	ARCIERI Stefano	3/9	33	0/2	1/3	0/1		2/3						
15	MENGON Simone	1/5	20			1/5								
18	MARTINI Oliver	1/2	50	0/1		1/1								
22	OPPEDISANO Axel	2/3	67	2/3										
32	PARISINI Andrea Carlo (C)	3/5	60	2/4				1/1						
66	PRANTNER Max	0/2	0	0/1		0/1								
<b>Bench/Team</b>														
<b>Totals</b>		34/58	59	12/21	2/7	7/16	5/5	7/8	1/1					

Goalkeepers		Saves							
No.	Name	S / S	%	6m	Wing	9m	7m	FB	BT
1	VOLAREVIC Mate	4/9	44	3/5		0/1	0/2	1/1	
12	COLLELUORI Andrea	12/32	38	2/8	3/4	7/18		0/2	
<b>Totals</b>		16/41	39	5/13	3/4	7/19	0/2	1/3	

**TUR - Turkiye**

No.	Name	Players		Shots						Punishment				
		G / S	%	6m	Wing	9m	7m	FB	BT	YC	2Min	RC	BC	
8	TINKIR Durmus Ali	4/7	57	1/1		3/6								
9	ILANC Genco	8/14	57	2/4		6/10								
12	YATKIN Enis													
16	GOKTEPE Coskun													
17	BICER Gorkem	1/4	25	0/1	1/3									
24	OZTURK Halil Ibrahim (C)	2/4	50			2/4								
30	BABACAN Ali Emre													
32	KELESOGLU Ilkan	2/2	100	2/2							1			
33	ATES Yasar Erdem	1/1	100					1/1						
34	YAGMUROGLU Sevket	1/3	33		0/1			1/2						
52	AYDIN Alper	1/1	100	1/1							3			
53	KANBEROGLU Samet	0/1	0	0/1							1			
61	PEHLIVAN Omur	0/1	0			0/1								
70	DURMAZ Tolga	1/1	100	1/1						1				
77	BILIM Gokay	2/3	67	0/1			2/2							
78	SIRIN Atakan	2/5	40	1/1		1/4								
<b>Bench/Team</b>														
<b>Totals</b>		25/47	53	8/13	1/4	12/25	2/2	2/3		1	5			

Goalkeepers		Saves							
No.	Name	S / S	%	6m	Wing	9m	7m	FB	BT
12	YATKIN Enis	14/48	29	6/18	4/6	3/10	0/5	1/8	0/1
16	GOKTEPE Coskun								
<b>Totals</b>		14/48	29	6/18	4/6	3/10	0/5	1/8	0/1



MON 4 JUL 2022

## Results

Start Time 12:30

Game Duration: 01:24

### RUNNING SCORE

1st Half		2nd Half	
SAVINI G.	1 (1') 0	22 (32') 12	TINKIR D.
BULZAMINI D.	2 (1') 0	23 (32') 12	SAVINI G.
ARCIERI S.	3 (2') 0	23 (32') 13	ILANC G.
ARCIERI S.	4 (3') 0	23 (33') 14	YAGMUROGLU S.
PARISINI A.	5 (3') 0	23 (35') 15	TINKIR D.
	5 (4') 1	23 (36') 16	ILANC G.
BULZAMINI D.	6 (4') 1	24 (38') 16	BULZAMINI D.
MORETTI A.	7 (5') 1	24 (38') 17	ILANC G.
ARCIERI S.	8 (6') 1	25 (40') 17	MENGON M.
	8 (7') 2	26 (43') 17	MORETTI A.
MENGON M.	9 (9') 2	27 (44') 17	PARISINI A.
	9 (9') 3	28 (44') 17	MENGON M.
MENGON M.	10 (10') 3	28 (45') 18	KELESOGLU I.
MORETTI A.	11 (11') 3	28 (45') 19	ILANC G.
	11 (14') 4	29 (46') 19	MENGON M.
BULZAMINI D.	12 (14') 4	29 (47') 20	TINKIR D.
	12 (15') 5	30 (49') 20	DAPIRAN G.
	12 (16') 6	30 (50') 21	BILIM G.
	12 (16') 7	31 (50') 21	MORETTI A.
D'ANTINO N.	13 (16') 7	31 (51') 22	DURMAZ T.
	13 (17') 8	31 (55') 23	AYDIN A.
PARISINI A.	14 (17') 8	31 (56') 24	ILANC G.
	14 (18') 9	32 (57') 24	OPPEDISANO A.
PRANTNER L.	15 (20') 9	33 (58') 24	MORETTI A.
	15 (20') 10	34 (59') 24	PRANTNER L.
MORETTI A.	16 (21') 10	34 (60') 25	BILIM G.
OPPEDISANO A.	17 (22') 10		
MARTINI O.	18 (25') 10		
PRANTNER L.	19 (28') 10		
	19 (29') 11		
MENGON S.	20 (29') 11		
MENGON M.	21 (30') 11		
DAPIRAN G.	22 (30') 11		

#### LEGEND

%	Efficiency	(C)	Captain	2Min	2 minutes suspension	6m	6 metre Shots
7m	7 metre Shots	7mS	7 metre Saves	9m	9 metre Shots	BC	Blue Cards
BT	Break Through Shots	FB	Fast Break Shots	G / S	Goals/Shots	No.	Uniform Number
RC	Red Cards	S	Saves	Wing	Wing Shots	YC	Yellow Card





## Cumulative Statistics

As of WED 6 JUL 2022 at 18:05

ALG - Algeria

Including Game 45

Player		MP	Shots								Offense		Defence		Punishment				TP
No.	Name		G/S	%	6m	Wing	9m	7m	FB	BT	AS	TO	ST	BS	YC	2Min	RC	BC	
2	NAIM Zohir	5	24/45	53	16/21	2/2	5/21		1/1						1				36:36:47
3	CHEHBOUR Nabil	5	3/15	20	2/7	0/2	0/5		1/1						1				48:47
4	HELLAL N.	5	8/9	89	3/4		2/2		3/3				1	1	4	1			49:22
6	BERKOUS M.	5	9/17	53	6/7		3/8	0/2											6:06:30
9	MELAZEM Wail	3	5/11	45			4/10	1/1							1				42:39
10	REMILI Hamza	5	4/6	67	3/4		1/2												55:55:35
15	SAKER Redouane	5	18/22	82	2/2	5/7	1/1	6/8	4/4		1								20:20:33
16	ZEMOUCHI Y.	5																	30:30:07
17	DJEDID Yacine	5	19/29	66	1/5	8/12	0/1	3/3	7/8		1	1			2				51:51:20
18	KAABECHE Hichem	5	2/6	33	2/4		0/2				1		3		1				36:36:32
22	GHEDBANE K.	5	1/1	100			1/1			1									49:49:36
26	KOURI Mokhtar	5	6/15	40	5/8		1/7				1				4				44:44:13
36	RAHIM A.	5	7/10	70	3/4		3/5		1/1			1	1						5:05:50
44	HADJ SADOK M.	5	12/26	46	7/13		5/11	0/2		1				1	2	1			21:21:43
77	ARIB Reda	5	17/25	68	5/9	8/10	1/2	1/2	2/2			1			1				2:02:17
87	ABDI Ayyoub	2	6/15	40	2/4		3/10		1/1						2				18:18:17
94	KHERMOUCHE B.	5	4/8	50	4/8									1	1				39:39:14
Bench/Team																			
<b>Totals</b>			145/260	56	61/100	23/33	30/88	11/18	20/21		2	4	3	5	3	20	2		

Goalkeepers		Total Shots		6m Shots		Wing Shots		9m Shots		7m Shots		Fast Breaks		Breakthrough	
No.	Name	S/S	%	S/S	%	S/S	%	S/S	%	S/S	%	S/S	%	S/S	%
16	ZEMOUCHI Yahia A	11/53	21	4/18	4	2/10	20	4/16	25	4/4	25	0/5			
22	GHEDBANE Khalifa	60/163	37	22/67	22	7/19	37	23/47	49	23/14	49	5/16	31		
<b>Totals</b>		71/216	33	26/85	26	9/29	31	27/63	43	27/18	43	5/21	24		

Team Shots	Goals	Saver	Missed	Post	Blocked	Total	%
6m Shots	61	27	6	6		100	61
Wing Shots	23	8		2		33	70
9m Shots	30	32	17	7	2	88	34
7m Shots	11	4	2	1	N/A	18	61
Fast Break Shots	20	1				21	95
Break Trough Shots							
<b>Totals</b>	145	72	25	16	2	260	56

Played		
PR	TUR	32 - 27
PR	MKD	24 - 24
PR	GRE	35 - 25
PR	ESP	19 - 31
F5	TUN	35 - 39

### LEGEND

%	Efficiency	2Min	2 minute suspensions	6m	6 metre Shots	7m	7 metre Shots
9m	9 metre Shots	AS	Assists	BC	Blue Cards	BS	Blocked Shots
BT	Break Through Shots	FB	Fast Break Shots	G / S	Goals / Shots	GM	Gold Medal Match
MP	Match Played	N/A	Not Applicable	No.	Uniform Number	PR	Preliminary Round
YC	Yellow Card	TP	Time Played	WS	Wing Shot	YC	Yellow Card



## Cumulative Statistics

As of WED 6 JUL 2022 at 18:05

EGY - Egypt

Including Game 45

Player		MP	Shots								Offense		Defence		Punishment			TP	
No.	Name		G/S	%	6m	Wing	9m	7m	FB	BT	AS	TO	ST	BS	YC	2Min	RC		BC
10	ABDOU A.	5	1/4	25	0/1		0/1	0/1	1/1				1		1				33:02
17	NASRALLA Ahmed	5	2/5	40	2/5														3:03:35
21	ABOUSALEM M.	4	3/3	100	2/2		1/1												34:33
24	ELMASRY Ibrahim	5	2/2	100	2/2								4		4				23:28
31	ELWAKIL Omar	5	12/18	67	4/7	5/6			3/5			1			1				26:26:05
39	ELDERAA Yehia	5	17/24	71	9/14		8/10			1		1			1				58:58:32
42	KADDAH Hassan	5	21/32	66	13/17		8/15						2		3				5:05:30
45	ELDERAA Seif	5	9/17	53	4/5	0/1	2/8		3/3						1				22:22:26
48	ABDELHAK Mohab	5	13/24	54	4/7		9/17				1				3				37:37:02
53	SAAD Akram	5	7/11	64	1/1	3/5		1/3	2/2			1							28:28:07
66	ELAHMAR Ahmed	5	21/31	68	6/6	3/5	2/8	10/11	0/1	1									33:33:49
80	MESILHY Ahmed	5	25/39	64	24/36		1/3								2				3:03:23
88	HENDAWY Karim	5	1/1	100					1/1										49:49:27
90	MOHAMED Ali	4	4/6	67	2/2		2/4				1		3	1					51:51:57
91	SANAD Mohammd	5	25/34	74	3/3	8/12		7/11	7/8			2			1				59:59:46
96	ELTAYAR Mohamed	5																	8:08:56
Bench/Team																			1
<b>Totals</b>			164/252	65	76/10	19/29	33/67	18/26	18/22		2	2	6	9	1	17			1

Goalkeepers		Total Shots		6m Shots		Wing Shots		9m Shots		7m Shots		Fast Breaks		Breakthrough	
No.	Name	S/S	%	S/S	%	S/S	%	S/S	%	S/S	%	S/S	%	S/S	%
88	HENDAWY Karim	29/107	27	13/49	13	3/13	23	13/29	45	13/4	45	0/12			
96	ELTAYAR Mohamed	21/80	26	6/30	6	3/14	21	8/22	36	8/6	36	2/8	25		
<b>Totals</b>		50/187	27	19/79	19	6/27	22	21/51	41	21/10	41	2/20	10		

Team Shots	Goals	Saver	Missed	Post	Blocked	Total	%
6m Shots	76	23	7	2		108	70
Wing Shots	19	8		2		29	66
9m Shots	33	24	6	3	1	67	49
7m Shots	18	7	1		N/A	26	69
Fast Break Shots	18	4				22	82
Break Trough Shots							
<b>Totals</b>	164	66	14	7	1	252	65

Played		
PR	ITA	38 - 35
PR	SRB	35 - 28
PR	TUN	30 - 26
PR	SLO	10 - 0
SFL	MKD	34 - 20
F1	ESP	27 - 28

### LEGEND

%	Efficiency	2Min	2 minute suspensions	6m	6 metre Shots	7m	7 metre Shots
9m	9 metre Shots	AS	Assists	BC	Blue Cards	BS	Blocked Shots
BT	Break Through Shots	FB	Fast Break Shots	G / S	Goals / Shots	GM	Gold Medal Match
MP	Match Played	N/A	Not Applicable	No.	Uniform Number	PR	Preliminary Round
YC	Yellow Card	TP	Time Played	WS	Wing Shot	YC	Yellow Card



## Cumulative Statistics

As of WED 6 JUL 2022 at 18:05

ESP - Spain

Including Game 45

Player		MP	Shots								Offense		Defence		Punishment				TP
No.	Name		G/S	%	6m	Wing	9m	7m	FB	BT	AS	TO	ST	BS	YC	2Min	RC	BC	
16	RODRIGUEZ R.	6																	52:52:21
18	GARCIANDIA I.	6	17/34	50	7/10	1/2	8/20		1/2	1	1								45:45:30
23	BAZAN A.	6	9/12	75	7/10	1/1			1/1				1		4				12:12:02
31	VALERA P.	6	9/15	60	6/7		3/8												34:34:34
36	TARRAFETA I.	6	23/31	74	12/15	0/2	11/14			1									42:42:12
49	MARTINEZ M.	6	12/17	71	6/7	0/1	4/6		2/3						1				52:52:56
55	IZQUIERDO A.	6	7/13	54	4/7		3/6			1		1			2				55:55:02
58	MARQUEZ J.	6	22/31	71	8/11	1/1	11/17		2/2						1				14:14:22
61	HERNANDEZ S.	6													1				6:06:49
62	ODRIOZOLA K.	6	26/36	72	3/4	9/12	1/1	7/10	6/9	2									12:12:53
63	FOLQUES J.	6	22/26	85	5/5	7/11	1/1		9/9						3				51:51:50
64	SERRANO J.	6	25/34	74	5/5	7/11	0/2	8/10	5/6	1		1							45:45:38
70	FERNANDEZ D.	6	19/23	83	2/4	7/9	1/1	1/1	8/8			1			1				10:10:38
72	GALLEGO J.	6	13/17	76	13/17								3	1	2				28:28:07
73	NIETO A.	6	14/19	74	6/7	2/3	4/5	0/1	2/3				3	1					16:16:15
74	MARTIN A.	6	6/6	100	5/5		1/1												6:06:46
Bench/Team																			
<b>Totals</b>			224/314	71	89/11	35/53	48/82	16/22	36/43		6	1	3	7	2	15			

Goalkeepers		Total Shots		6m Shots		Wing Shots		9m Shots		7m Shots		Fast Breaks		Breakthrough	
No.	Name	S/S	%	S/S	%	S/S	%	S/S	%	S/S	%	S/S	%	S/S	%
16	RODRIGUEZ LARIO Roberto	28/76	37	11/35	11	4/11	36	13/25	52	13/5	52				
61	HERNANDEZ FERRER Sergey	63/161	39	12/53	12	8/20	40	41/67	61	41/13	61	1/8	13		
<b>Totals</b>		91/237	38	23/88	23	12/31	39	54/92	59	54/18	59	1/8	13		

Team Shots	Goals	Saver	Missed	Post	Blocked	Total	%
6m Shots	89	17	5	3		114	78
Wing Shots	35	12	3	3		53	66
9m Shots	48	20	5	3	6	82	59
7m Shots	16	5	1		N/A	22	73
Fast Break Shots	36	6		1		43	84
Break Trough Shots							
<b>Totals</b>	224	60	14	10	6	314	71

Played		
PR	TUR	46 - 19
PR	MKD	31 - 22
PR	GRE	46 - 21
PR	ALG	31 - 19
SFL	SRB	42 - 38
F1	EGY	28 - 27

### LEGEND

%	Efficiency	2Min	2 minute suspensions	6m	6 metre Shots	7m	7 metre Shots
9m	9 metre Shots	AS	Assists	BC	Blue Cards	BS	Blocked Shots
BT	Break Through Shots	FB	Fast Break Shots	G / S	Goals / Shots	GM	Gold Medal Match
MP	Match Played	N/A	Not Applicable	No.	Uniform Number	PR	Preliminary Round
YC	Yellow Card	TP	Time Played	WS	Wing Shot	YC	Yellow Card



## Cumulative Statistics

As of WED 6 JUL 2022 at 18:05

GRE - Greece

Including Game 45

Player		MP	Shots								Offense		Defence		Punishment				TP
No.	Name		G/S	%	6m	Wing	9m	7m	FB	BT	AS	TO	ST	BS	YC	2Min	RC	BC	
2	STEFANITSIS I.	5	10/11	91		5/6		5/5											47:47:14
3	SINA Armando	5	6/11	55	2/4	4/7									1				40:40:13
5	STATHIS M.	5	0/1					0/1											28:13
6	PAGIATIS E.	5	8/13	62	6/9			0/2		2/2		1		1					28:28:36
7	PAPAGIANNIS C.	5	5/10	50	2/3	2/5	1/2												27:27:25
8	TZORTZINIS N.	5	8/19	42	2/4	6/10	0/5												7:07:23
9	PAPAZOGLU A.	5	11/21	52	3/3	0/1	7/16			1/1				1		1			28:28:13
11	DIKAIOLIAS N.	5	9/15	60	9/15											2	1		3:03:36
12	BAMPATZANIDIS	5																	51:51:47
13	ALEXANDRIDIS P.	5	4/6	67	3/4			1/2											51:22
15	TOSKAS A.	5	9/19	47	4/4			5/15											56:56:51
17	ANASTASIOU E.	5	7/16	44	0/2			7/14						1					38:38:34
18	PANAGIOTOU D.	5	4/11	36	1/4	0/1	3/6						1						9:09:09
19	KOTSIONIS K.	3	6/17	35	1/1			5/16					1	1					38:38:40
21	GEROULANOS A.	5	6/12	50	1/1			5/11											13:13:56
30	ASLIS Nikolaos	5																	7:07:07
Bench/Team															1				
<b>Totals</b>			93/182	51	34/54	17/30	34/90	5/5	3/3		1	2	3	2	1	15	1		

Goalkeepers		Total Shots		6m Shots		Wing Shots		9m Shots		7m Shots		Fast Breaks		Breakthrough	
No.	Name	S/S	%	S/S	%	S/S	%	S/S	%	S/S	%	S/S	%	S/S	%
12	BAMPATZANIDIS Dimitrios	20/128	16	4/45	4	7/31	23	7/32	22	7/4	22	1/15	7	1/1	100
30	ASLIS Nikolaos	10/50	20	2/16	2	0/7		5/18	28	5/5	28	1/4	25		
<b>Totals</b>		30/178	17	6/61	6	7/38	18	12/50	24	12/9	24	2/19	11	1/1	100

Team Shots	Goals	Saver	Missed	Post	Blocked	Total	%
6m Shots	34	16	1	1	2	54	63
Wing Shots	17	11	1	1		30	57
9m Shots	34	36	13	3	4	90	38
7m Shots	5				N/A	5	100
Fast Break Shots	3					3	100
Break Trough Shots							
<b>Totals</b>	93	63	15	5	6	182	51

Played		
PR	MKD	21 - 39
PR	ALG	25 - 35
PR	ESP	21 - 46
PR	TUR	26 - 28
F9	SLO	10 - 0

### LEGEND

%	Efficiency	2Min	2 minute suspensions	6m	6 metre Shots	7m	7 metre Shots
9m	9 metre Shots	AS	Assists	BC	Blue Cards	BS	Blocked Shots
BT	Break Through Shots	FB	Fast Break Shots	G / S	Goals / Shots	GM	Gold Medal Match
MP	Match Played	N/A	Not Applicable	No.	Uniform Number	PR	Preliminary Round
YC	Yellow Card	TP	Time Played	WS	Wing Shot	YC	Yellow Card



## Cumulative Statistics

As of WED 6 JUL 2022 at 18:05

ITA - Italy

### Including Game 45

Player		MP	Shots								Offense		Defence		Punishment				TP
No.	Name		G/S	%	6m	Wing	9m	7m	FB	BT	AS	TO	ST	BS	YC	2Min	RC	BC	
1	VOLAREVIC Mate	4																	0:00:56
2	MORETTI Alessio	4	16/29	55	2/7	0/1	5/11	9/10							2				34:34:03
4	PRANTNER Leo	3	10/11	91	4/4	3/4							1						2:02:54
5	DAPIRAN G.	4	9/12	75	3/4	3/5						2/2	1/1						1:01:28
6	BULZAMINI D.	4	8/14	57	3/5			4/8				1/1			4		1		21:21:18
8	SAVINI Giacomo	4	8/11	73	6/8			2/3											58:58:51
10	MENGON Marco	4	16/24	67	9/13			4/8				3/3			1		2		2:02:23
11	D'ANTINO N.	4	12/15	80	4/4	6/9						2/2			1				51:51:09
12	COLLELUORI A.	4																	59:59:09
14	ARCIERI Stefano	4	12/20	60	3/5	6/9	0/1					3/5				1			6:06:11
15	MENGON Simone	4	8/18	44	2/3	1/1	2/11					3/3				1			0:00:12
18	MARTINI Oliver	4	2/3	67	1/2		1/1												7:25
19	BORTOLI Thomas	3	6/7	86	5/5	1/2													11:11:56
22	OPPEDISANO Axel	4	5/8	63	3/4				2/4										47:02
32	PARISINI A.	4	18/28	64	16/25			0/1				2/2					1		54:54:45
66	PRANTNER Max	4	1/6	17	1/4			0/2											1:01:22
	Bench/Team																	1	
<b>Totals</b>			131/206	64	62/93	20/31	18/46	11/14	19/21	1/1	2	1	2	6	1	7			

Goalkeepers		Total Shots		6m Shots		Wing Shots		9m Shots		7m Shots		Fast Breaks		Breakthrough	
No.	Name	S/S	%	S/S	%	S/S	%	S/S	%	S/S	%	S/S	%	S/S	%
1	VOLAREVIC Mate	21/91	23	9/40	9	2/8	25	6/25	24	6/8	24	3/10	30		
12	COLLELUORI Andrea	22/83	27	6/31	6	3/9	33	11/31	35	11/3	35	2/9	22		
<b>Totals</b>		43/174	25	15/71	15	5/17	29	17/56	30	17/11	30	5/19	26		

Team Shots	Goals	Saver	Missed	Post	Blocked	Total	%
6m Shots	62	26	4	1		93	67
Wing Shots	20	9	2			31	65
9m Shots	18	14	10	3	1	46	39
7m Shots	11	3			N/A	14	79
Fast Break Shots	19	2				21	90
Break Trough Shots	1					1	100
<b>Totals</b>	131	54	16	4	1	206	64

Played		
PR	EGY	35 - 38
PR	SRB	33 - 34
PR	TUN	29 - 34
PR	SLO	10 - 0
F7	TUR	34 - 25

#### LEGEND

%	Efficiency	2Min	2 minute suspensions	6m	6 metre Shots	7m	7 metre Shots
9m	9 metre Shots	AS	Assists	BC	Blue Cards	BS	Blocked Shots
BT	Break Through Shots	FB	Fast Break Shots	G / S	Goals / Shots	GM	Gold Medal Match
MP	Match Played	N/A	Not Applicable	No.	Uniform Number	PR	Preliminary Round
YC	Yellow Card	TP	Time Played	WS	Wing Shot	YC	Yellow Card



## Cumulative Statistics

As of WED 6 JUL 2022 at 18:05

MKD - North Macedonia

Including Game 45

Player		MP	Shots								Offense		Defence		Punishment			TP	
No.	Name		G/S	%	6m	Wing	9m	7m	FB	BT	AS	TO	ST	BS	YC	2Min	RC		BC
8	DJONOV Ivan	6	18/31	58	6/12	6/7	4/9	1/2	1/1	1	1				2			54:54:51	
9	GJORGIEV Igor	6	15/28	54	8/10		6/16		1/2	1	1	1			2			36:36:53	
10	MITEV Marko	6	6/13	46	4/6	0/2	2/5							2	1			2:02:59	
19	KOSTESKI Nenad	6	13/19	68	2/2	7/10	1/2		3/4	0/1			2			1		26:26:00	
20	KIZIKJ Marko	6																32:32:42	
21	PETKOVSKI A.	6	20/30	67		9/14	0/1	10/14	1/1		1							19:19:25	
23	IVANOSKI Mihail	6	0/1		0/1								1	1	2			5:16	
31	MLADENOVIKJ M.	6	2/7	29	1/2		1/5						2		2			40:40:04	
34	JAGURINOSKI T.	6	11/22	50	6/8		3/12		2/2	2	3	1		1	2			37:37:40	
42	STOJKOVIKJ M.	6	10/11	91	8/9				2/2		1		2		2			9:09:12	
55	ATANASIJEVIKJ	6	17/27	63	4/5	10/15	0/2		3/5				1		2			11:11:47	
77	SERAFIMOV M.	6	25/51	49	3/5	0/1	6/23	15/21	1/1	1	2	1			3			31:31:35	
88	SIMONOSKI K.	6	3/8	38	3/6		0/1	0/1					1					53:25	
89	ATANASIJEVIKJ	6	10/23	43	3/5	0/2	5/14		2/2				1	1		4		57:57:01	
92	PETROV Kostadin	6	14/20	70	14/19		0/1			1								40:40:01	
98	GOGOVI Vasil	6	1/1	100			1/1			1								26:26:50	
Bench/Team															3				
<b>Totals</b>			165/292	57	62/90	32/51	29/92	26/38	16/20	0/1	7	9	7	7	7	23			

Goalkeepers		Total Shots		6m Shots		Wing Shots		9m Shots		7m Shots		Fast Breaks		Breakthrough	
No.	Name	S/S	%	S/S	%	S/S	%	S/S	%	S/S	%	S/S	%	S/S	%
20	KIZIKJ Marko	57/158	36	17/56	17	9/22	41	28/51	55	28/13	55	0/16			
98	GOGOVI Vasil	39/104	38	10/42	10	5/20	25	16/25	64	16/10	64	5/7	71		
<b>Totals</b>		96/262	37	27/98	27	14/42	33	44/76	58	44/23	58	5/23	22		

Team Shots	Goals	Saver	Missed	Post	Blocked	Total	%
6m Shots	62	22	6			90	69
Wing Shots	32	14	4	1		51	63
9m Shots	29	38	11	8	6	92	32
7m Shots	26	7	1	4	N/A	38	68
Fast Break Shots	16	3		1		20	80
Break Trough Shots		1				1	
<b>Totals</b>	165	85	22	14	6	292	57

Played		
PR	GRE	39 - 21
PR	ALG	24 - 24
PR	ESP	22 - 31
PR	TUR	31 - 22
SFL	EGY	20 - 34
F3	SRB	29 - 34

### LEGEND

%	Efficiency	2Min	2 minute suspensions	6m	6 metre Shots	7m	7 metre Shots
9m	9 metre Shots	AS	Assists	BC	Blue Cards	BS	Blocked Shots
BT	Break Through Shots	FB	Fast Break Shots	G / S	Goals / Shots	GM	Gold Medal Match
MP	Match Played	N/A	Not Applicable	No.	Uniform Number	PR	Preliminary Round
YC	Yellow Card	TP	Time Played	WS	Wing Shot	YC	Yellow Card



## Cumulative Statistics

As of WED 6 JUL 2022 at 18:05

SLO - Slovenia

Including Game 45

Player			Shots									Offense		Defence		Punishment				TP	
No.	Name	MP	G/S	%	6m	Wing	9m	7m	FB	BT	AS	TO	ST	BS	YC	2Min	RC	BC			
1	SKLEDAR Alen	2																		0:00	
4	MILICEVIC Uros	2																		0:00	
5	HORVAT Gasper	2																		0:00	
6	MAZEJ Tadej	2																		0:00	
7	ZAGAR Matevz	2																		0:00	
8	ROZMAN Tim	2																		0:00	
9	TAJNIK Domen	2																		0:00	
10	COKAN Tim	2																		0:00	
11	PIPP Urban	2																		0:00	
13	GRMSEK Timotej	2																		0:00	
14	SLATINEK S.	2																		0:00	
15	SIKOSEK D.	2																		0:00	
16	DOBAJ Gasper	2																		0:00	
17	KLJUN Tadej	2																		0:00	
18	KOTAR Marko	2																		0:00	
20	DROBEZ Jernej	2																		0:00	
Bench/Team																					
<b>Totals</b>																					

Goalkeepers		Total Shots		6m Shots		Wing Shots		9m Shots		7m Shots		Fast Breaks		Breakthrough	
No.	Name	S/S	%	S/S	%	S/S	%	S/S	%	S/S	%	S/S	%	S/S	%
1	SKLEDAR Alen														
16	DOBAJ Gasper														
<b>Totals</b>															

Team Shots	Goals	Saver	Missed	Post	Blocked	Total	%
6m Shots							
Wing Shots							
9m Shots							
7m Shots					N/A		
Fast Break Shots							
Break Trough Shots							
<b>Totals</b>							

Played		
PR	SRB	0 - 10
PR	TUN	0 - 10
PR	EGY	0 - 10
PR	ITA	0 - 10
F9	GRE	0 - 10

### LEGEND

%	Efficiency	2Min	2 minute suspensions	6m	6 metre Shots	7m	7 metre Shots
9m	9 metre Shots	AS	Assists	BC	Blue Cards	BS	Blocked Shots
BT	Break Through Shots	FB	Fast Break Shots	G / S	Goals / Shots	GM	Gold Medal Match
MP	Match Played	N/A	Not Applicable	No.	Uniform Number	PR	Preliminary Round
YC	Yellow Card	TP	Time Played	WS	Wing Shot	YC	Yellow Card



## Cumulative Statistics

As of WED 6 JUL 2022 at 18:05

SRB - Serbia

Including Game 45

Player		MP	Shots								Offense		Defence		Punishment				TP
No.	Name		G/S	%	6m	Wing	9m	7m	FB	BT	AS	TO	ST	BS	YC	2Min	RC	BC	
1	BOMASTAR Milan	6	0/1			0/1												48:48:20	
3	VORKAPIC V.	6	22/29	76	5/5	10/16		7/8			1	1			4			4:04:37	
5	MILIC Milan	6	25/43	58	10/12	0/1	15/29	0/1				1		2	6			19:19:45	
6	BORZAS Uros	6	23/44	52	9/14	1/2	12/27	1/1						2	3			18:18:49	
12	JANDRIC Todor	6																11:11:23	
16	TRNAVAC Andrej	5																0:00	
17	KOJADINOVIC U.	6	9/12	75	4/4	1/2	3/5	1/1					1		2			7:07:57	
18	PAVLOVIC Uros	6	3/6	50	3/5	0/1									3	1		57:00	
20	GOLUBOVIC Milan	6	1/1	100			1/1								1			54:51	
23	POPOVIC Veljko	6	8/11	73	6/8		1/1	1/2		1					2			4:04:59	
24	VIGNJEVIC Marko	6	2/3	67	1/1		0/1	1/1			1		1		2			7:03	
28	SOTIC Mladen	6	3/5	60	2/2	1/1	0/2											32:32:54	
33	PETRIC Stefan	6	5/7	71	1/2		4/5											24:47	
34	POPOVIC Ivan	6	20/26	77	18/24		1/1	1/1			1			3	8			58:58:07	
39	MILOSAVLJEVIC	6	19/36	53	6/13	1/1	11/20	1/2			1				1			8:08:48	
69	GROZDANIC Milos	6	29/35	83	3/4	10/14		14/15	2/2		1				1			28:28:13	
Bench/Team														1					
<b>Totals</b>			169/259	65	68/94	24/38	48/93	14/15	15/19		1	5	2	2	8	33	1		

Goalkeepers		Total Shots		6m Shots		Wing Shots		9m Shots		7m Shots		Fast Breaks		Breakthrough	
No.	Name	S/S	%	S/S	%	S/S	%	S/S	%	S/S	%	S/S	%	S/S	%
1	BOMASTAR Milan	30/96	31	11/38	11	6/21	29	9/20	45	9/7	45	1/10	10		
12	JANDRIC Todor	45/147	31	12/56	12	8/24	33	15/33	45	15/16	45	4/18	22		
<b>Totals</b>		75/243	31	23/94	23	14/45	31	24/53	45	24/23	45	5/28	18		

Team Shots	Goals	Saver	Missed	Post	Blocked	Total	%
6m Shots	68	19	5	2		94	72
Wing Shots	24	9	3	2		38	63
9m Shots	48	22	8	5	10	93	52
7m Shots	14	1			N/A	15	93
Fast Break Shots	15	3	1			19	79
Break Trough Shots							
<b>Totals</b>	169	54	17	9	10	259	65

Played		
PR	SLO	10 - 0
PR	EGY	28 - 35
PR	ITA	34 - 33
PR	TUN	35 - 29
SFL	ESP	38 - 42
F3	MKD	34 - 29

### LEGEND

%	Efficiency	2Min	2 minute suspensions	6m	6 metre Shots	7m	7 metre Shots
9m	9 metre Shots	AS	Assists	BC	Blue Cards	BS	Blocked Shots
BT	Break Through Shots	FB	Fast Break Shots	G / S	Goals / Shots	GM	Gold Medal Match
MP	Match Played	N/A	Not Applicable	No.	Uniform Number	PR	Preliminary Round
YC	Yellow Card	TP	Time Played	WS	Wing Shot	YC	Yellow Card





## Cumulative Statistics

As of WED 6 JUL 2022 at 18:05

TUN - Tunisia

Including Game 45

Player		MP	Shots								Offense		Defence		Punishment				TP
No.	Name		G/S	%	6m	Wing	9m	7m	FB	BT	AS	TO	ST	BS	YC	2Min	RC	BC	
9	BANNOUR Amine	5	8/16	50	4/5	1/2	3/9				1								41:41:03
10	ABDELLI Bilel	5	11/23	48	4/7	2/4	4/10		1/2										9:09:01
13	BHAR M.	5	9/11	82	3/3	3/3			3/5										18:18:34
21	BOUGHANMI O.	5	25/37	68	4/4	3/8	1/4	10/12	7/9						3				29:29:10
22	MAAREF Yousef	5	7/13	54	1/2	0/2	6/9								2				26:26:49
27	RZIG Issam	5	14/17	82	3/3	3/4		2/4	6/6			1		1					40:40:00
28	BACHA Hazem	5	12/20	60	4/5		7/13		1/2										5:05:02
45	MUSTAPHA Ala	5	1/3	33	1/2		0/1								1				23:12
55	TOUMI Ghassen	5	3/5	60	1/1	1/2			1/2					1					53:38
57	MAOUA N.	5	1/4	25		1/3	0/1					1	1		2	1			20:20:16
61	BELKAIED Y.	5																	5:05:19
69	JABALLAH Jihed	5	12/16	75	10/13	2/2	0/1				1				2				45:45:40
71	DARMOUL M.	5	12/19	63	7/11	1/1	4/6		0/1										10:10:16
90	CHOUIREF M.	5	10/14	71	8/11		0/1		2/2							4			33:33:31
92	JAZIRI Oussama	5	3/7	43	1/2		2/5							1	2				1:01:04
94	HARBAOUI M.	3																	30:22
Bench/Team															3				
<b>Totals</b>			128/205	62	51/69	17/31	27/60	12/16	21/29			2	1	2	4	18	1		

Goalkeepers		Total Shots		6m Shots		Wing Shots		9m Shots		7m Shots		Fast Breaks		Breakthrough	
No.	Name	S/S	%	S/S	%	S/S	%	S/S	%	S/S	%	S/S	%	S/S	%
61	BELKAIED Yassine	27/91	30	14/45	14	6/13	46	5/19	26	5/6	26	2/8	25		
94	HARBAOUI Mehdi Sadri	7/23	30	3/13	3	1/2	50	1/2	50	1/5	50	0/1			
<b>Totals</b>		34/114	30	17/58	17	7/15	47	6/21	29	6/11	29	2/9	22		

Team Shots	Goals	Saver	Missed	Post	Blocked	Total	%
6m Shots	51	15	1	2		69	74
Wing Shots	17	9	3	2		31	55
9m Shots	27	15	8	6	4	60	45
7m Shots	12	4			N/A	16	75
Fast Break Shots	21	4	3	1		29	72
Break Trough Shots							
<b>Totals</b>	128	47	15	11	4	205	62

Played		
PR	SLO	10 - 0
PR	EGY	26 - 30
PR	ITA	34 - 29
PR	SRB	29 - 35
F5	ALG	39 - 35

### LEGEND

%	Efficiency	2Min	2 minute suspensions	6m	6 metre Shots	7m	7 metre Shots
9m	9 metre Shots	AS	Assists	BC	Blue Cards	BS	Blocked Shots
BT	Break Through Shots	FB	Fast Break Shots	G / S	Goals / Shots	GM	Gold Medal Match
MP	Match Played	N/A	Not Applicable	No.	Uniform Number	PR	Preliminary Round
YC	Yellow Card	TP	Time Played	WS	Wing Shot	YC	Yellow Card



## Cumulative Statistics

As of WED 6 JUL 2022 at 18:05

TUR - Turkiye

Including Game 45

Player		MP	Shots								Offense		Defence		Punishment			TP
No.	Name		G/S	%	6m	Wing	9m	7m	FB	BT	AS	TO	ST	BS	YC	2Min	RC	
8	TINKIR D.	5	12/22	55	5/6	0/1	7/15								2			38:38:33
9	ILANC Genco	5	10/22	45	2/4		8/18								3			15:15:19
12	YATKIN Enis	5																11:11:35
16	GOKTEPE Coskun	5													1			47:47:21
17	BICER Gorkem	5	16/28	57	4/6	8/14	0/2	2/2	2/4			1			1			30:30:24
24	OZTURK H.	5	11/26	42	3/4		8/22				1				2	1		46:46:46
27	SIRIN Atakan	5	14/25	56	9/13		5/11	0/1										37:37:42
30	BABACAN A.	5	2/7	29	2/2		0/5				1							38:45
32	KELESOGLU Ilkan	5	7/7	100	6/6		1/1								5			46:46:28
33	ATES Y.	5	3/6	50	0/1	0/1	1/1		2/3									47:47:34
34	YAGMUROGLU S.	5	6/11	55	0/1	4/6			2/4									52:16
52	AYDIN Alper	5	5/7	71	5/7								1	2	8			24:34
53	KANBEROGLU S.	5	1/10	10	0/1	1/4		0/2	0/3		1				1	1		20:20:09
61	PEHLIVAN Omur	5	14/21	67	10/10	1/1	3/10								1	1		42:42:22
70	DURMAZ Tolga	5	15/18	83	15/18						1			1	1	1		26:26:47
77	BILIM Gokay	5	5/9	56	1/2		1/4	3/3										6:06:45
Bench/Team															2	1		
<b>Totals</b>			121/219	55	62/81	14/27	34/89	5/8	6/14			4	1	1	5	25	5	

Goalkeepers		Total Shots		6m Shots		Wing Shots		9m Shots		7m Shots		Fast Breaks		Breakthrough	
No.	Name	S/S	%	S/S	%	S/S	%	S/S	%	S/S	%	S/S	%	S/S	%
12	YATKIN Enis	27/105	26	8/36	8	6/16	38	10/20	50	10/16	50	2/16	13	0/1	
16	GOKTEPE Coskun	33/123	27	4/35	4	8/23	35	17/44	39	17/6	39	2/15	13		
<b>Totals</b>		60/228	26	12/71	12	14/39	36	27/64	42	27/22	42	4/31	13	0/1	

Team Shots	Goals	Saver	Missed	Post	Blocked	Total	%
6m Shots	62	17		2		81	77
Wing Shots	14	10	2		1	27	52
9m Shots	34	35	14	2	4	89	38
7m Shots	5	1		2	N/A	8	63
Fast Break Shots	6	8				14	43
Break Trough Shots							
<b>Totals</b>	121	71	16	6	5	219	55

Played		
PR	ALG	27 - 32
PR	ESP	19 - 46
PR	MKD	22 - 31
PR	GRE	28 - 26
F7	ITA	25 - 34

### LEGEND

%	Efficiency	2Min	2 minute suspensions	6m	6 metre Shots	7m	7 metre Shots
9m	9 metre Shots	AS	Assists	BC	Blue Cards	BS	Blocked Shots
BT	Break Through Shots	FB	Fast Break Shots	G / S	Goals / Shots	GM	Gold Medal Match
MP	Match Played	N/A	Not Applicable	No.	Uniform Number	PR	Preliminary Round
YC	Yellow Card	TP	Time Played	WS	Wing Shot	YC	Yellow Card



## Overall Team Statistics

As of WED 6 JUL 2022 at 18:06

### Players

Team	MP	Total Shots		6m Shots		Wing Shots		9m Shots		7m Shots		Fast Breaks		Breakthroughs		Offence		Defence		Punishments			
		G/S	%	G/S	%	G/S	%	G/S	%	G/S	%	G/S	%	G/S	%	AS	TO	ST	BS	YC	2M	RC	BC
ALG	5	145/260	56	61/100	61	23/33	70	30/88	34	11/18	61	20/21	95	0/0		2	4	3	5	3	20	2	
EGY	6	164/252	65	76/108	70	19/29	66	33/67	49	18/26	69	18/22	82	0/0		2	2	6	9	1	17		1
ESP	6	224/314	71	89/114	78	35/53	66	48/82	59	16/22	73	36/43	84	0/0		6	1	3	7	2	15		
GRE	5	93/182	51	34/54	63	17/30	57	34/90	38	5/5	10	3/3	100	0/0		1	2	3	2	1	15	1	
ITA	5	131/206	64	62/93	67	20/31	65	18/46	39	11/14	79	19/21	90	1/1	100	2	1	2	6	1	7		
MKD	6	165/292	57	62/90	69	32/51	63	29/92	32	26/38	68	16/20	80	0/1		7	9	7	7	7	23		
SLO	3	0/0		0/0		0/0		0/0		0/0		0/0		0/0									
SRB	6	169/259	65	68/94	72	24/38	63	48/93	52	14/15	93	15/19	79	0/0		1	5	2	2	8	33	1	
TUN	5	128/205	62	51/69	74	17/31	55	27/60	45	12/16	75	21/29	72	0/0		2	1	2	4	4	18	1	
TUR	5	121/219	55	62/81	77	14/27	52	34/89	38	5/8	63	6/14	43	0/0		4	1	1	5	25	5		
<b>Total</b>		1340/2189	61	565/803	70	201/323	62	301/707	43	118/162	73	154/192	80	1/2	50	21	30	28	41	32	173	10	1

### Goalkeepers

Team	MP	Total Shots		6m Shots		Wing Shots		9m Shots		7m Shots		Fast Breaks		Breakthroughs	
		S/S	%	S/S	%	S/S	%	S/S	%	S/S	%	S/S	%	S/S	%
ALG	5	71/216	33	26/85	31	9/29	31	27/63	43	4/18	22	5/21	24	0/0	
EGY	6	50/187	27	19/79	24	6/27	22	21/51	41	2/10	20	2/20	10	0/0	
ESP	6	91/237	38	23/88	26	12/31	39	54/92	59	1/18	6	1/8	13	0/0	
GRE	5	30/178	17	6/61	10	7/38	18	12/50	24	2/9	22	2/19	11	1/1	100
ITA	5	43/174	25	15/71	21	5/17	29	17/56	30	1/11	9	5/19	26	0/0	
MKD	6	96/262	37	27/98	28	14/42	33	44/76	58	6/23	26	5/23	22	0/0	
SLO	3	0/0		0/0		0/0		0/0		0/0		0/0		0/0	
SRB	6	75/243	31	23/94	24	14/45	31	24/53	45	9/23	39	5/28	18	0/0	
TUN	5	34/114	30	17/58	29	7/15	47	6/21	29	2/11	18	2/9	22	0/0	
TUR	5	60/228	26	12/71	17	14/39	36	27/64	42	3/22	14	4/31	13	0/1	
<b>Total</b>		550/183	30	168/705	24	88/283	31	232/526	44	30/145	21	31/178	17	1/2	50

### LEGEND

%	Efficiency	2Min	2 minute suspensions	AS	Assists	BC	Blue Cards
BS	Blocked Shots	G / S	Goals/Shots	MP	Match Played	RC	Red Card
S / S	Saved / shots	ST	Steals	TO	Turnovers		



## Individual Statistics

As of WED 6 JUL 2022 at 18:08

### GOALSCORERS

Rank	Name	Team	Goal	Shots	%	7 M Shots	MP
1	Milos GROZDANIC	SRB	29	35	83	14/15	6
2	Kauldi ODRIQZOLA YEREGUI	ESP	26	36	72	7/10	6
3	Oussama BOUGHANMI	TUN	25	37	68	10/12	5
3	Ahmed MESILHY	EGY	25	39	64		5
3	Milan MILIC	SRB	25	43	58		6
3	Mohammd SANAD	EGY	25	34	74	7/11	5
3	Martin SERAFIMOV	MKD	25	51	49	15/21	6
3	Jorge SERRANO VILLALOBOS	ESP	25	34	74	8/10	6
9	Zohir NAIM	ALG	24	45	53		5
10	Uros BORZAS	SRB	23	44	52		6
10	Ian TARRAFETA SERRANO	ESP	23	31	74		6
12	Josep FOLQUES ORTIZ	ESP	22	26	85		6
12	Jose Maria MARQUEZ COLOMA	ESP	22	31	71		6
12	Vukasin VORKAPIC	SRB	22	29	76		6
15	Ahmed ELAHMAR	EGY	21	31	68	10/11	5
15	Hassan KADDAH	EGY	21	32	66		5
17	Aleksandar PETKOVSKI	MKD	20	30	67	10/14	6
17	Ivan POPOVIC	SRB	20	26	77		6
19	Yacine DJEDID	ALG	19	29	66	3/3	5
19	Daniel FERNANDEZ JIMENEZ	ESP	19	23	83	1/1	6
19	Marko MILOSAVLJEVIC	SRB	19	36	53		6
22	Ivan DJONOV	MKD	18	31	58	1/2	6
22	Andrea Carlo PARISINI	ITA	18	28	64		4
22	Redouane SAKER	ALG	18	22	82	6/8	5
25	Reda ARIB	ALG	17	25	68	1/2	5
25	Petar ATANASIJEVIKJ	MKD	17	27	63		6
25	Yehia ELDERAA	EGY	17	24	71		5
25	Imanol GARCIA DIA ALUSTIZA	ESP	17	34	50		6
29	Gorkem BICER	TUR	16	28	57	2/2	5
29	Marco MENGON	ITA	16	24	67		4
29	Alessio MORETTI	ITA	16	29	55	9/10	4
32	Tolga DURMAZ	TUR	15	18	83		5
32	Igor GJORGIEV	MKD	15	28	54		6
34	Asier NIETO MARCOS	ESP	14	19	74	0/1	6
34	Omur PEHLIVAN	TUR	14	21	67		5
34	Kostadin PETROV	MKD	14	20	70		6
34	Issam RZIG	TUN	14	17	82	2/4	5
34	Atakan SIRIN	TUR	14	25	56	0/1	5
39	Mohab ABDELHAK	EGY	13	24	54		5
39	Jaime GALLEGO MURO	ESP	13	17	76		6
39	Nenad KOSTESKI	MKD	13	19	68		6
42	Stefano ARCIERI	ITA	12	20	60		4
42	Hazem BACHA	TUN	12	20	60		5



## Individual Statistics

As of WED 6 JUL 2022 at 18:08

Rank	Name	Team	Goals	Shots	%	7m Shots	MP
42	Nicolo' D'ANTINO	ITA	12	15	80		4
42	Mohamed Amine DARMOUL	TUN	12	19	63		5
42	Omar ELWAKIL	EGY	12	18	67		5
42	Moustafa HADJ SADOK	ALG	12	26	46	0/2	5
42	Jihed JABALLAH	TUN	12	16	75		5
42	Miguel MARTINEZ LOBATO	ESP	12	17	71		6
42	Durmus Ali TINKIR	TUR	12	22	55		5
51	Bilel ABDELLI	TUN	11	23	48		5
51	Tomislav JAGURINOSKI	MKD	11	22	50		6
51	Halil Ibrahim OZTURK	TUR	11	26	42		5
51	Athanasios PAPAZOGLU	GRE	11	21	52		5
55	Pavle ATANASIJEVIKJ	MKD	10	23	43		6
55	Marouan CHOUIREF	TUN	10	14	71		5
55	Genco ILANC	TUR	10	22	45		5
55	Leo PRANTNER	ITA	10	11	91		3
55	Ioannis STEFANITSIS	GRE	10	11	91	5/5	5
55	Marko STOJKOVIKJ	MKD	10	11	91		6
61	Antonio BAZAN LEGASA	ESP	9	12	75		6
61	Messaoud BERKOUS	ALG	9	17	53	0/2	5
61	Mohamed Ali BHAR	TUN	9	11	82		5
61	Gianluca DAPIRAN	ITA	9	12	75		4
61	Nikolaos Marios DIKAIOLIAS	GRE	9	15	60		5
61	Seif ELDERAA	EGY	9	17	53		5
61	Uros KOJADINOVIC	SRB	9	12	75		6
61	Achilleas TOSKAS	GRE	9	19	47		5
61	Pol VALERA ROVIRA	ESP	9	15	60		6
70	Amine BANNOUR	TUN	8	16	50		5
70	Davide BULZAMINI	ITA	8	14	57		4
70	Nour-eddine HELLAL	ALG	8	9	89		5
70	Simone MENGON	ITA	8	18	44		4
70	Eleftherios PAGIATIS	GRE	8	13	62		5
70	Veljko POPOVIC	SRB	8	11	73		6
70	Giacomo SAVINI	ITA	8	11	73		4
70	Nikolaos TZORTZINIS	GRE	8	19	42		5
78	Eleftherios ANASTASIOU	GRE	7	16	44		5
78	Ander IZQUIERDO LABAYEN	ESP	7	13	54		6
78	Ilkan KELESOGLU	TUR	7	7	100		5
78	Yousef MAAREF	TUN	7	13	54		5
78	Abdelkader RAHIM	ALG	7	10	70		5
78	Akram SAAD	EGY	7	11	64	1/3	5
84	Ayyoub ABDI	ALG	6	15	40		2
84	Thomas BORTOLI	ITA	6	7	86		3
84	Andreas GEROULANOS	GRE	6	12	50		5
84	Konstantinos KOTSIONIS	GRE	6	17	35		3
84	Mokhtar KOURI	ALG	6	15	40		5



## Individual Statistics

As of WED 6 JUL 2022 at 18:08

Rank	Name	Team	Goals	Shots	%	7m Shots	MP
84	Alberto MARTIN BOTET	ESP	6	6	100		6
84	Marko MITEV	MKD	6	13	46		6
84	Armando SINA	GRE	6	11	55		5
84	Sevket YAGMUROGLU	TUR	6	11	55		5
93	Alper AYDIN	TUR	5	7	71		5
93	Gokay BILIM	TUR	5	9	56	3/3	5
93	Wail MELAZEM	ALG	5	11	45	1/1	3
93	Axel OPPEDISANO	ITA	5	8	63	2/4	4
93	Christos PAPAGIANNIS	GRE	5	10	50		5
93	Stefan PETRIC	SRB	5	7	71		6
99	Pantelis Leonidas ALEXANDRIDIS	GRE	4	6	67		5
99	Bastien Jean R KHERMOUCHE	ALG	4	8	50		5
99	Ali MOHAMED	EGY	4	6	67		4
99	Dimitrios PANAGIOTOU	GRE	4	11	36		5
99	Hamza REMILI	ALG	4	6	67		5
104	Mohamed ABOUSALEM	EGY	3	3	100		4
104	Yasar Erdem ATES	TUR	3	6	50		5
104	Nabil CHEHBOUR	ALG	3	15	20		5
104	Oussama JAZIRI	TUN	3	7	43		5
104	Uros PAVLOVIC	SRB	3	6	50		6
104	Kristijan SIMONOSKI	MKD	3	8	38	0/1	6
104	Mladen SOTIC	SRB	3	5	60		6
104	Ghassen TOUMI	TUN	3	5	60		5
112	Ali Emre BABACAN	TUR	2	7	29		5
112	Ibrahim ELMASRY	EGY	2	2	100		5
112	Hichem KAABECHE	ALG	2	6	33		5
112	Oliver MARTINI	ITA	2	3	67		4
112	Mihajlo MLADENOVIKJ	MKD	2	7	29		6
112	Ahmed NASRALLA	EGY	2	5	40		5
112	Marko VIGNJEVIC	SRB	2	3	67		6
119	Abdelrahman ABDOU	EGY	1	4	25	0/1	5
119	Khalifa GHEDBANE	ALG	1	1	100		5
119	Vasil GOGOV	MKD	1	1	100		6
119	Milan GOLUBOVIC	SRB	1	1	100		6
119	Karim HENDAWY	EGY	1	1	100		5
119	Samet KANBEROGLU	TUR	1	10	10	0/2	5
119	Noureddine MAOUA	TUN	1	4	25		5
119	Ala MUSTAPHA	TUN	1	3	33		5
119	Max PRANTNER	ITA	1	6	17		4
128	Milan BOMASTAR	SRB	1	1			6
128	Mihail IVANOSKI	MKD	1	1			6
128	Michail Nektarios STATHIS	GRE	1	1			5



## Individual Statistics

As of WED 6 JUL 2022 at 18:08

### ASSISTS

Rank	Name	Team	Assists	MP
1	Tomislav JAGURINOSKI	MKD	2	6
1	Kauldi ODRIQZOLA YEREGUI	ESP	2	6
3	Ivan DJONOV	MKD	1	6
3	Ahmed ELAHMAR	EGY	1	5
3	Yehia ELDERAA	EGY	1	5
3	Imanol GARCIAANDIA ALUSTIZA	ESP	1	6
3	Khalifa GHEDBANE	ALG	1	5
3	Igor GJORGIEV	MKD	1	6
3	Vasil GGOV	MKD	1	6
3	Moustafa HADJ SADOK	ALG	1	5
3	Ander IZQUIERDO LABAYEN	ESP	1	6
3	Simone MENGON	ITA	1	4
3	Eleftherios PAGIATIS	GRE	1	5
3	Kostadin PETROV	MKD	1	6
3	Veljko POPOVIC	SRB	1	6
3	Max PRANTNER	ITA	1	4
3	Martin SERAFIMOV	MKD	1	6
3	Jorge SERRANO VILLALOBOS	ESP	1	6
3	Ian TARRAFETA SERRANO	ESP	1	6



## Individual Statistics

As of WED 6 JUL 2022 at 18:08

### GOALS AND ASSISTS

Rank	Name	Team	Goal+Assi	Goals	Assists	MP
1	GROZDANIC Milos	SRB	29	29		6
2	ODRIOZOLA YEREGUI Kauldi	ESP	28	26	2	6
3	SERAFIMOV Martin	MKD	26	25	1	6
3	SERRANO VILLALOBOS Jorge	ESP	26	25	1	6
5	BOUGHANMI Oussama	TUN	25	25		5
5	MESILHY Ahmed	EGY	25	25		5
5	MILIC Milan	SRB	25	25		6
5	SANAD Mohammd	EGY	25	25		5
9	NAIM Zohir	ALG	24	24		5
9	TARRAFETA SERRANO Ian	ESP	24	23	1	6
11	BORZAS Uros	SRB	23	23		6
12	ELAHMAR Ahmed	EGY	22	21	1	5
12	FOLQUES ORTIZ Josep	ESP	22	22		6
12	MARQUEZ COLOMA Jose Maria	ESP	22	22		6
12	VORKAPIC Vukasin	SRB	22	22		6
16	KADDAH Hassan	EGY	21	21		5
17	PETKOVSKI Aleksandar	MKD	20	20		6
17	POPOVIC Ivan	SRB	20	20		6
19	DJEDID Yacine	ALG	19	19		5
19	DJONOV Ivan	MKD	19	18	1	6
19	FERNANDEZ JIMENEZ Daniel	ESP	19	19		6
19	MILOSAVLJEVIC Marko	SRB	19	19		6
23	ELDERAA Yehia	EGY	18	17	1	5
23	GARCIANDIA ALUSTIZA Imanol	ESP	18	17	1	6
23	PARISINI Andrea Carlo	ITA	18	18		4
23	SAKER Redouane	ALG	18	18		5
27	ARIB Reda	ALG	17	17		5
27	ATANASIJEVIKJ Petar	MKD	17	17		6
29	BICER Gorkem	TUR	16	16		5
29	GJORGIEV Igor	MKD	16	15	1	6
29	MENGON Marco	ITA	16	16		4
29	MORETTI Alessio	ITA	16	16		4
33	DURMAZ Tolga	TUR	15	15		5
33	PETROV Kostadin	MKD	15	14	1	6
35	NIETO MARCOS Asier	ESP	14	14		6
35	PEHLIVAN Omur	TUR	14	14		5
35	RZIG Issam	TUN	14	14		5
35	SIRIN Atakan	TUR	14	14		5
39	ABDELHAK Mohab	EGY	13	13		5
39	GALLEGO MURO Jaime	ESP	13	13		6
39	HADJ SADOK Moustafa	ALG	13	12	1	5
39	JAGURINOSKI Tomislav	MKD	13	11	2	6
39	KOSTESKI Nenad	MKD	13	13		6





## Individual Statistics

As of WED 6 JUL 2022 at 18:08

Rank	Name	Team	Goal+Assi	Goals	Assists	MP
44	ARCIERI Stefano	ITA	12	12		4
44	BACHA Hazem	TUN	12	12		5
44	D'ANTINO Nicolo'	ITA	12	12		4
44	DARMOUL Mohamed Amine	TUN	12	12		5
44	ELWAKIL Omar	EGY	12	12		5
44	JABALLAH Jihed	TUN	12	12		5
44	MARTINEZ LOBATO Miguel	ESP	12	12		6
44	TINKIR Durmus Ali	TUR	12	12		5
52	ABDELLI Bilel	TUN	11	11		5
52	OZTURK Halil Ibrahim	TUR	11	11		5
52	PAPAZOGLU Athanasios	GRE	11	11		5
55	ATANASIJEVIKJ Pavle	MKD	10	10		6
55	CHOUIREF Marouan	TUN	10	10		5
55	ILANC Genco	TUR	10	10		5
55	PRANTNER Leo	ITA	10	10		3
55	STEFANITSIS Ioannis	GRE	10	10		5
55	STOJKOVIKJ Marko	MKD	10	10		6
61	BAZAN LEGASA Antonio	ESP	9	9		6
61	BERKOUS Messaoud	ALG	9	9		5
61	BHAR Mohamed Ali	TUN	9	9		5
61	DAPIRAN Gianluca	ITA	9	9		4
61	DIKAIOLIAS Nikolaos Marios	GRE	9	9		5
61	ELDERAA Seif	EGY	9	9		5
61	KOJADINOVIC Uros	SRB	9	9		6
61	MENGON Simone	ITA	9	8	1	4
61	PAGIATIS Eleftherios	GRE	9	8	1	5
61	POPOVIC Veljko	SRB	9	8	1	6
61	TOSKAS Achilleas	GRE	9	9		5
61	VALERA ROVIRA Pol	ESP	9	9		6
73	BANNOUR Amine	TUN	8	8		5
73	BULZAMINI Davide	ITA	8	8		4
73	HELLAL Nour-eddine	ALG	8	8		5
73	IZQUIERDO LABAYEN Ander	ESP	8	7	1	6
73	SAVINI Giacomo	ITA	8	8		4
73	TZORTZINIS Nikolaos	GRE	8	8		5
79	ANASTASIOU Eleftherios	GRE	7	7		5
79	KELESOGLU Ilkan	TUR	7	7		5
79	MAAREF Yousef	TUN	7	7		5
79	RAHIM Abdelkader	ALG	7	7		5
79	SAAD Akram	EGY	7	7		5
84	ABDI Ayyoub	ALG	6	6		2
84	BORTOLI Thomas	ITA	6	6		3
84	GEROULANOS Andreas	GRE	6	6		5
84	KOTSIONIS Konstantinos	GRE	6	6		3
84	KOURI Mokhtar	ALG	6	6		5



## Individual Statistics

As of WED 6 JUL 2022 at 18:08

Rank	Name	Team	Goal+Assi	Goals	Assists	MP
84	MARTIN BOTET Alberto	ESP	6	6		6
84	MITEV Marko	MKD	6	6		6
84	SINA Armando	GRE	6	6		5
84	YAGMUROGLU Sevket	TUR	6	6		5
93	AYDIN Alper	TUR	5	5		5
93	BILIM Gokay	TUR	5	5		5
93	MELAZEM Wail	ALG	5	5		3
93	OPPEDISANO Axel	ITA	5	5		4
93	PAPAGIANNIS Christos	GRE	5	5		5
93	PETRIC Stefan	SRB	5	5		6
99	ALEXANDRIDIS Pantelis Leonidas	GRE	4	4		5
99	KHERMOUCHE Bastien Jean R	ALG	4	4		5
99	MOHAMED Ali	EGY	4	4		4
99	PANAGIOTOU Dimitrios	GRE	4	4		5
99	REMILI Hamza	ALG	4	4		5
104	ABOUSALEM Mohamed	EGY	3	3		4
104	ATES Yasar Erdem	TUR	3	3		5
104	CHEHBOUR Nabil	ALG	3	3		5
104	JAZIRI Oussama	TUN	3	3		5
104	PAVLOVIC Uros	SRB	3	3		6
104	SIMONOSKI Kristijan	MKD	3	3		6
104	SOTIC Mladen	SRB	3	3		6
104	TOUMI Ghassen	TUN	3	3		5
112	BABACAN Ali Emre	TUR	2	2		5
112	ELMASRY Ibrahim	EGY	2	2		5
112	GHEDBANE Khalifa	ALG	2	1	1	5
112	GOGOV Vasil	MKD	2	1	1	6
112	KAABECHE Hichem	ALG	2	2		5
112	MARTINI Oliver	ITA	2	2		4
112	MLADENOVIKJ Mihajlo	MKD	2	2		6
112	NASRALLA Ahmed	EGY	2	2		5
112	PRANTNER Max	ITA	2	1	1	4
112	VIGNJEVIC Marko	SRB	2	2		6
122	ABDOU Abdelrahman	EGY	1	1		5
122	GOLUBOVIC Milan	SRB	1	1		6
122	HENDAWY Karim	EGY	1	1		5
122	KANBEROGLU Samet	TUR	1	1		5
122	MAOUA Nouredine	TUN	1	1		5
122	MUSTAPHA Ala	TUN	1	1		5



## Individual Statistics

As of WED 6 JUL 2022 at 18:08

### STEALS

Rank	Name	Team	Total	Avg.	MP
1	Nenad KOSTESKI	MKD	2	0.3	6
1	Mohammd SANAD	EGY	2	0.4	5
3	Abdelrahman ABDOU	EGY	1	0.2	5
3	Reda ARIB	ALG	1	0.2	5
3	Pavle ATANASIJEVIKJ	MKD	1	0.2	6
3	Petar ATANASIJEVIKJ	MKD	1	0.2	6
3	Gorkem BICER	TUR	1	0.2	5
3	Nicolo' D'ANTINO	ITA	1	0.3	4
3	Yacine DJEDID	ALG	1	0.2	5
3	Yehia ELDERAA	EGY	1	0.2	5
3	Omar ELWAKIL	EGY	1	0.2	5
3	Daniel FERNANDEZ JIMENEZ	ESP	1	0.2	6
3	Igor GJORGIEV	MKD	1	0.2	6
3	Ander IZQUIERDO LABAYEN	ESP	1	0.2	6
3	Tomislav JAGURINOSKI	MKD	1	0.2	6
3	Konstantinos KOTSIONIS	GRE	1	0.3	3
3	Noureddine MAOUA	TUN	1	0.2	5
3	Milan MILIC	SRB	1	0.2	6
3	Eleftherios PAGIATIS	GRE	1	0.2	5
3	Dimitrios PANAGIOTOU	GRE	1	0.2	5
3	Leo PRANTNER	ITA	1	0.3	3
3	Abdelkader RAHIM	ALG	1	0.2	5
3	Akram SAAD	EGY	1	0.2	5
3	Martin SERAFIMOV	MKD	1	0.2	6
3	Jorge SERRANO VILLALOBOS	ESP	1	0.2	6
3	Vukasin VORKAPIC	SRB	1	0.2	6



## Individual Statistics

As of WED 6 JUL 2022 at 18:08

### BLOCKD SHOTS

Rank	Name	Team	Total	Avg.	MP
1	BULZAMINI Davide	ITA	4	1.0	4
1	ELMASRY Ibrahim	EGY	4	0.8	5
3	GALLEGO MURO Jaime	ESP	3	0.5	6
3	KAABECHE Hichem	ALG	3	0.6	5
3	MOHAMED Ali	EGY	3	0.8	4
3	NIETO MARCOS Asier	ESP	3	0.5	6
7	KADDAH Hassan	EGY	2	0.4	5
7	MLADENOVIKJ Mihajlo	MKD	2	0.3	6
7	STOJKOVIKJ Marko	MKD	2	0.3	6
10	ANASTASIOU Eleftherios	GRE	1	0.2	5
10	ATANASIJEVIKJ Pavle	MKD	1	0.2	6
10	AYDIN Alper	TUR	1	0.2	5
10	BAZAN LEGASA Antonio	ESP	1	0.2	6
10	HELLAL Nour-eddine	ALG	1	0.2	5
10	IVANOSKI Mihail	MKD	1	0.2	6
10	KOJADINOVIC Uros	SRB	1	0.2	6
10	MAOUA Noureddine	TUN	1	0.2	5
10	MENGON Marco	ITA	1	0.3	4
10	PAPAZOULOU Athanasios	GRE	1	0.2	5
10	PARISINI Andrea Carlo	ITA	1	0.3	4
10	RAHIM Abdelkader	ALG	1	0.2	5
10	RZIG Issam	TUN	1	0.2	5
10	SIMONOSKI Kristijan	MKD	1	0.2	6
10	VIGNJEVIC Marko	SRB	1	0.2	6



## Individual Statistics

As of WED 6 JUL 2022 at 18:08

### PUNISHMENT

Rank	Name	Team	Points		BC	RC	2Min	YC	MP
			Avg.	Total					
1	Alper AYDIN	TUR	3.6	18			8	2	5
2	Ivan POPOVIC	SRB	3.2	19			8	3	6
3	Nour-eddine HELLAL	ALG	2.8	14		1	4	1	5
4	Milan MILIC	SRB	2.3	14			6	2	6
5	Ayyoub ABDI	ALG	2.0	4			2	0	2
5	Moustafa HADJ SADOK	ALG	2.0	10		1	2	1	5
5	Ilkan KELESOGLU	TUR	2.0	10			5	0	5
8	Nikolaos Marios DIKAIOLIAS	GRE	1.8	9		1	2	0	5
8	Noureddine MAOUA	TUN	1.8	9		1	2	0	5
8	Halil Ibrahim OZTURK	TUR	1.8	9		1	2	0	5
8	Uros PAVLOVIC	SRB	1.8	11		1	3	0	6
12	Marouan CHOUIREF	TUN	1.6	8			4	0	5
12	Tolga DURMAZ	TUR	1.6	8		1	1	1	5
12	Ibrahim ELMASRY	EGY	1.6	8			4	0	5
12	Mokhtar KOURI	ALG	1.6	8			4	0	5
16	Samet KANBEROGLU	TUR	1.4	7		1	1	0	5
16	Omur PEHLIVAN	TUR	1.4	7		1	1	0	5
18	Pavle ATANASIJEVIKJ	MKD	1.3	8			4	0	6
18	Antonio BAZAN LEGASA	ESP	1.3	8			4	0	6
18	Uros BORZAS	SRB	1.3	8			3	2	6
18	Vukasin VORKAPIC	SRB	1.3	8			4	0	6
22	Mohab ABDELHAK	EGY	1.2	6			3	0	5
22	Eleftherios ANASTASIOU	GRE	1.2	6			3	0	5
22	Oussama BOUGHANMI	TUN	1.2	6			3	0	5
22	Genco ILANC	TUR	1.2	6			3	0	5
22	Hassan KADDAH	EGY	1.2	6			3	0	5
27	Josep FOLQUES ORTIZ	ESP	1.0	6			3	0	6
27	Oussama JAZIRI	TUN	1.0	5			2	1	5
27	Marco MENGON	ITA	1.0	4			2	0	4
27	Alessio MORETTI	ITA	1.0	4			2	0	4
27	Martin SERAFIMOV	MKD	1.0	6			3	0	6
32	Pantelis Leonidas ALEXANDRIDIS	GRE	0.8	4			2	0	5
32	Yacine DJEDID	ALG	0.8	4			2	0	5
32	Jaime GALLEGRO MURO	ESP	0.8	5			2	1	6
32	Mihail IVANOSKI	MKD	0.8	5			2	1	6
32	Jihed JABALLAH	TUN	0.8	4			2	0	5
32	Tomislav JAGURINOSKI	MKD	0.8	5			2	1	6
32	Yousef MAAREF	TUN	0.8	4			2	0	5
32	Ahmed MESILHY	EGY	0.8	4			2	0	5
32	Dimitrios PANAGIOTOU	GRE	0.8	4			2	0	5
32	Durmus Ali TINKIR	TUR	0.8	4			2	0	5
42	Petar ATANASIJEVIKJ	MKD	0.7	4			2	0	6
42	Ivan DJONOV	MKD	0.7	4			2	0	6



## Individual Statistics

As of WED 6 JUL 2022 at 18:08

Rank	Name	Team	Points		BC	RC	2Min	YC	MP
			Avg.	Total					
42	Igor GJORGIEV	MKD	0.7	4			2	0	6
42	Ander IZQUIERDO LABAYEN	ESP	0.7	4			2	0	6
42	Uros KOJADINOVIC	SRB	0.7	4			2	0	6
42	Konstantinos KOTSIONIS	GRE	0.7	2			1	0	3
42	Wail MELAZEM	ALG	0.7	2			1	0	3
42	Marko MITEV	MKD	0.7	4			1	2	6
42	Mihajlo MLADENOVIKJ	MKD	0.7	4			2	0	6
42	Veljko POPOVIC	SRB	0.7	4			2	0	6
42	Marko STOJKOVIKJ	MKD	0.7	4			2	0	6
42	Marko VIGNJEVIC	SRB	0.7	4			2	0	6
54	Bastien Jean R KHERMOUCHE	ALG	0.6	3			1	1	5
55	Stefano ARCIERI	ITA	0.5	2			1	0	4
55	Davide BULZAMINI	ITA	0.5	2			1	0	4
55	Simone MENGON	ITA	0.5	2			1	0	4
58	Abdelrahman ABDOU	EGY	0.4	2			1	0	5
58	Reda ARIB	ALG	0.4	2			1	0	5
58	Gorkem BICER	TUR	0.4	2			1	0	5
58	Nabil CHEHBOUR	ALG	0.4	2			1	0	5
58	Seif ELDERAA	EGY	0.4	2			1	0	5
58	Yehia ELDERAA	EGY	0.4	2			1	0	5
58	Omar ELWAKIL	EGY	0.4	2			1	0	5
58	Coskun GOKTEPE	TUR	0.4	2			1	0	5
58	Hichem KAABECHE	ALG	0.4	2			1	0	5
58	Ala MUSTAPHA	TUN	0.4	2			1	0	5
58	Zohir NAIM	ALG	0.4	2			1	0	5
58	Eleftherios PAGIATIS	GRE	0.4	2			1	0	5
58	Athanasios PAPAZOGLU	GRE	0.4	2			1	0	5
58	Issam RZIG	TUN	0.4	2			1	0	5
58	Mohammd SANAD	EGY	0.4	2			1	0	5
58	Armando SINA	GRE	0.4	2			1	0	5
58	Achilleas TOSKAS	GRE	0.4	2			1	0	5
58	Ghassen TOUMI	TUN	0.4	2			1	0	5
58	Nikolaos TZORTZINIS	GRE	0.4	2			1	0	5
77	Daniel FERNANDEZ JIMENEZ	ESP	0.3	2			1	0	6
77	Milan GOLUBOVIC	SRB	0.3	2			1	0	6
77	Milos GROZDANIC	SRB	0.3	2			1	0	6
77	Sergey HERNANDEZ FERRER	ESP	0.3	2			1	0	6
77	Nenad KOSTESKI	MKD	0.3	2			1	0	6
77	Jose Maria MARQUEZ COLOMA	ESP	0.3	2			1	0	6
77	Miguel MARTINEZ LOBATO	ESP	0.3	2			1	0	6
77	Marko MILOSAVLJEVIC	SRB	0.3	2			1	0	6
77	Ali MOHAMED	EGY	0.3	1				1	4
86	Asier NIETO MARCOS	ESP	0.2	1				1	6



## Individual Statistics

As of WED 6 JUL 2022 at 18:08

Rank	Name	Team	Points		BC	RC	2Min	YC	MP
			Avg.	Total					

### LEGEND

-  
-



## Goalkeepers Statistics

As of WED 6 JUL 2022 at 18:08

Including Game 45

### SHOTS

Minimum 20% of total shots received by team

Rank	Name	Team	%	Saves	Shots	MP
1	HERNANDEZ FERRER Sergey	ESP	39	63	161	6
2	GOGOVI Vasil	MKD	38	39	104	6
3	GHEDBANE Khalifa	ALG	37	60	163	5
3	RODRIGUEZ LARIO Roberto	ESP	37	28	76	6
5	KIZIKJ Marko	MKD	36	57	158	6
6	BOMASTAR Milan	SRB	31	30	96	6
6	JANDRIC Todor	SRB	31	45	147	6
8	BELKAIED Yassine	TUN	30	27	91	5
8	HARBAOUI Mehdi Sadri	TUN	30	7	23	3
10	COLLELUORI Andrea	ITA	27	22	83	4
10	GOKTEPE Coskun	TUR	27	33	123	5
10	HENDAWY Karim	EGY	27	29	107	5
13	ELTAYAR Mohamed	EGY	26	21	80	5
13	YATKIN Enis	TUR	26	27	105	5
15	VOLAREVIC Mate	ITA	23	21	91	4
16	ZEMOUCHI Yahia A	ALG	21	11	53	5
17	ASLIS Nikolaos	GRE	20	10	50	5
18	BAMPATZANIDIS Dimitrios	GRE	16	20	128	5





## Goalkeepers Statistics

As of WED 6 JUL 2022 at 18:08

Including Game 45

7m PENALTY SHOTS

Minimum 20% of total shots received by team

Rank	Name	Team	%	Saves	Shots	MP
1	BOMASTAR Milan	SRB	43	3	7	6
2	ASLIS Nikolaos	GRE	40	2	5	5
2	HARBAOUI Mehdi Sadri	TUN	40	2	5	3
4	JANDRIC Todor	SRB	38	6	16	6
5	ELTAYAR Mohamed	EGY	33	2	6	5
5	GOKTEPE Coskun	TUR	33	2	6	5
7	GOGOVA Vasil	MKD	30	3	10	6
8	ZEMOUCHI Yahia A	ALG	25	1	4	5
9	KIZIKJ Marko	MKD	23	3	13	6
10	GHEDBANE Khalifa	ALG	21	3	14	5
11	VOLAREVIC Mate	ITA	13	1	8	4
12	HERNANDEZ FERRER Sergey	ESP	8	1	13	6
13	YATKIN Enis	TUR	6	1	16	5
14	BAMPATZANIDIS Dimitrios	GRE			4	5
14	BELKAIED Yassine	TUN			6	5
14	COLLELUORI Andrea	ITA			3	4
14	HENDAWY Karim	EGY			4	5
14	RODRIGUEZ LARIO Roberto	ESP			5	6

### LEGEND

% Efficiency

MP Matches Played



## Team Fair Play

As of WED 6 JUL 2022 at 18:06

Rank	Team	Points		BC	RC	2Min	YC	MP
		Avg.	Total					
1	TUR-Turkiye	16.0	80	0	5	25	5	5
2	SRB-Serbia	13.2	79	0	1	33	8	6
3	ALG-Algeria	10.6	53	0	2	20	3	5
4	TUN-Tunisia	9.0	45	0	1	18	4	5
5	MKD-North Macedonia	8.8	53	0	0	23	7	6
6	EGY-Egypt	7.5	45	1	0	17	1	6
7	GRE-Greece	7.2	36	0	1	15	1	5
8	ESP-Spain	5.3	32	0	0	15	2	6
9	ITA-Italy	3.0	15	0	0	7	1	5

### LEGEND

-  
-



## Medallists

As of WED 6 JUL 2022 at 15:44

Gold	Silver	Bronze
<b>ESP - Spain</b>	<b>CRO - Croatia</b>	<b>SRB - Serbia</b>
6 CAMPOS COSTA Carmen	1 BESEN Lucija	1 SIMIC Marija
7 ARROJERIA Esther	6 SENVALD Sara	2 RADEVIC Dunja
13 HERNANDEZ SELVA Laura	8 POSAVEC Stela	4 MIJALOVIC Lana
23 SPUGNINI SANTOME Alba Chiara	19 JAPUNDA Tena	5 CETKOVIC Natasa
29 GOMES DA COSTA Maria	23 PAVLOVIC Katarina	6 OBRENOVIC Una
31 VEGUE I PENNA Ona	28 SIMARA Andrea	7 VUKAJLOVIC Aleksandra
32 CUADRADO SANCHEZ Elena	32 MALEC Ana	8 INDIC Helena
33 GASSAMA CISSOKHO Kaba	38 BARISIC Tina	9 SUKUR Srna
38 LOIDI ETXANIZ June	40 PETIKA Tena	10 BOGUNOVIC Isidora
41 WIGGINS SANCHO Nicole	47 TUCAKOVIC Antonija	12 DURASINOVIC Jelena
45 AALLA ROTAECHE Maddi	51 JARAK Lana	13 JOVANOVIC Marija
47 VALERO JODAR Sara	53 VOJNOVIC Nika	14 NUKOVIC Edita
53 MBENGUE RODRIGUEZ Seynabou	54 GUSKIC Ema	15 VELICKOVIC Teodora
57 VALDIVIA MONSERRAT Paula Maria	58 BEBEK Josipa	22 JOVOVIC Jovana
64 GASCO ARRANZ Clara	61 TUPEK Mia	30 TABAK Dunja
67 ALVAREZ TORRADO Elba		31 BOJICIC Katarina



## Team Roster

As of SUN 26 JUN 2022 at 14:36

### ALG - Algeria

No.	Name	Pos	L/R	Height m/ ft in	Weight kg / lbs	Date of Birth	Age	Club	Int. Matches Played	Int. G. Scored
1	GABOUR Naima			1.75 / 5' 9	60 / 132	20 DEC 1997	24			
2	AROUJ Leila					23 SEP 1997	24			
5	AMRANI Nassima			1.75 / 5' 9	60 / 132	1 AUG 1993	28			
7	HAIMER Fatiha			1.75 / 5' 9	60 / 132	6 DEC 1993	28			
8	ZAZAI Sabrina			1.75 / 5' 9	75 / 165	19 OCT 1994	27			
9	YELLES Loudmila Manel			1.75 / 5' 9	75 / 165	19 NOV 1996	25			
10	DJABOUR Waffya					29 MAR 1998	24			
11	TAIBI Tasnime Shanez			1.75 / 5' 9	71 / 157	23 FEB 1994	28			
13	MAKHOULFI Kenza			1.75 / 5' 9	70 / 154	9 SEP 1997	24			
19	BELOUHRANI Ferial			1.75 / 5' 9	60 / 132	27 JAN 1998	24			
22	SALHI Tinhinane			1.75 / 5' 9	700 / 1543	6 AUG 1997	24			
23	DERRADJ Imen					2 DEC 1998	23			
26	ZOUAOUI Sylia			1.75 / 5' 9	70 / 154	27 MAY 1996	26			
27	AZZI Sarah			1.75 / 5' 9	60 / 132	28 DEC 1997	24			
31	BOUKAABENE Meriem			1.75 / 5' 9	60 / 132	6 JAN 1995	27			
33	BENABDELHAFID Nadia			1.75 / 5' 9	75 / 165	24 JUN 1990	32			
<b>Team averages</b>				1.75 / 5' 9	115.1 / 25		25.8			

Coach	MOUCI Kamel
Coach	GRAICHI Rabah
Coach	AMAIRI Hassane
Doctor	DAIKHI Lilia
Physiotherapist	ARIBA Asma

#### LEGEND

<b>B</b> Both Handed	<b>B</b> Back	<b>CB</b> Centre Back	<b>FP</b> Joueur
<b>GK</b> Goalkeeper	<b>Int.</b> International	<b>L</b> Left Handed	<b>LB</b> Left Back
<b>LW</b> Left Wing	<b>No.</b> Uniform Number	<b>P</b> Pivot	<b>Pos</b> Position
<b>R</b> Right Handed	<b>RB</b> Right Back	<b>RW</b> Right Wing	<b>W</b> Wing
-			



## Team Roster

As of SUN 26 JUN 2022 at 14:36

### CRO - Croatia

No.	Name	Pos	L/R	Height m/ ft in	Weight kg / lbs	Date of Birth	Age	Club	Int. Matches			
									Played	Int. G. Scored		
1	BESEN Lucija	GK	Right	1.80 / 5' 11"	74 / 163	29 MAR 1998	24	RK LOKOMOTIVA, ZAGREB (CRO)	26			
6	SEINVALD Sara	P	Right	1.85 / 6' 1"	77 / 170	14 MAR 1996	26	RK PODRAVKA, KOPRIVNICA (CRO)	6			
8	POSAVEC Stela	CB	Right	1.65 / 5' 5"	61 / 134	26 AUG 1996	25	RK PODRAVKA, KOPRIVNICA (CRO)	45			
19	JAPUNDZA Tena	RW	Left	1.73 / 5' 8"	64 / 141	28 OCT 1998	23	RK LOKOMOTIVA, ZAGREB (CRO)	12			
23	PAVLOVIC Katarina	RB	Left	1.80 / 5' 11"	77 / 170	30 JAN 1995	27	ROCASA GRAN CANARIA, TELDE, GR	2			
28	SIMARA Andrea	LW	Right	1.71 / 5' 7"	59 / 130	13 JUL 1997	24	RK LOKOMOTIVA, ZAGREB (CRO)	24			
32	MALEC Ana	CB	Right	1.74 / 5' 9"	70 / 154	25 JUL 2000	21	RK LOKOMOTIVA, Zagreb (CRO)				
38	BARISIC Tina	LB	Right	1.85 / 6' 1"	82 / 181	30 OCT 2000	21	RK PODRAVKA, KOPRIVNICA (CRO)	1			
40	PETIKA Tena	LB	Right	1.90 / 6' 3"	85 / 187	16 JUN 2000	22	RK LOKOMOTIVA, ZAGREB (CRO)	3			
47	TUCAKOVIC Antonija	GK	Right	1.72 / 5' 8"	62 / 137	9 MAY 1992	30	RK PODRAVKA, KOPRIVNICA (CRO)	5			
51	JARAK Lana	LW	Right	1.68 / 5' 6"	60 / 132	13 APR 2000	22	RK DALMATINKA, PLOCE (CRO)				
53	VOJNOVIC Nika	P	Right	1.80 / 5' 11"	75 / 165	22 OCT 2000	21	ŽRK BJELOVAR, BJELOVAR (CRO)				
54	GUSKIC Ema	LB	Right	1.80 / 5' 11"	71 / 157	28 NOV 2001	20	ŽRK BJELOVAR, BJELOVAR (CRO)	2			
58	BEBEK Josipa	RW	Right	1.70 / 5' 7"	57 / 126	17 SEP 1997	24	RK DUGO SELO 55, Dugo Selo (CRO)				
61	TUPEK Mia	CB	Right	1.74 / 5' 9"	64 / 141	13 JUN 2000	22	RK SESVETE AGROPROTEINKA, Sesv				
<b>Team averages</b>									1.76 / 5' 9"	69.2 / 153	23.5	10.5

#### Uniform Color (Shirts - Shorts)

1st	White	Red
2nd	Red	White
3rd	Blue	

Coach	SOSTARIC Nenad
Coach	PETIKA Snjezana
Coach	BILUSIC Matija
Physiotherapist	KRUSELJ Goran
Physiotherapist	HODIC Vesna
Physiotherapist	KOVACIC Nikola

#### LEGEND

<b>B</b> Both Handed	<b>B</b> Back	<b>CB</b> Centre Back	<b>FP</b> Joueur
<b>GK</b> Goalkeeper	<b>Int.</b> International	<b>L</b> Left Handed	<b>LB</b> Left Back
<b>LW</b> Left Wing	<b>No.</b> Uniform Number	<b>P</b> Pivot	<b>Pos</b> Position
<b>R</b> Right Handed	<b>RB</b> Right Back	<b>RW</b> Right Wing	<b>W</b> Wing



## Team Roster

As of SUN 26 JUN 2022 at 14:36

### ESP - Spain

No.	Name	Pos	L/R	Height m/ ft in	Weight kg / lbs	Date of Birth	Age	Club	Int. Matches	Int. G.
									Played	Scored
6	CAMPOS COSTA Carmen	CB	Right	1.71 / 5' 7	67 / 148	10 JUL 1995	26	ADJ DIJON, DIJON (FRA)	34	
7	ARROJERIA Esther	CB	Right	1.64 / 5' 5	60 / 132	11 FEB 1994	28	BERA BERA, SAN SEBASTIAN (ESP)	2	
13	HERNANDEZ SELVA Laura	LW	Right	1.71 / 5' 7	74 / 163	13 MAY 1997	25	BERA BERA, SAN SEBASTIAN (ESP)	13	
23	SPUGNINI SANTOME Alba Chiara	P	Right	1.80 / 5' 1	86 / 190	30 JUN 2000	21	BM REMUDAS, GRAN CANARIAS (ESP)	12	
29	GOMES DA COSTA Maria	LB	Right	1.77 / 5' 1	77 / 170	13 APR 1999	23	BM REMUDAS, GRAN CANARIAS (ESP)		
31	VEGUE I PENA Ona	LW	Right	1.70 / 5' 7	61 / 134	9 JUL 1998	23	BM GRANOLLERS, GRANOLLERS (ES)	4	
32	CUADRADO SANCHEZ Elena	LB	Right	1.71 / 5' 7	70 / 154	15 APR 1999	23	BM AULA, VALLADOLID (ESP)		
33	GASSAMA CISSOKHO Kaba	P	Right	1.80 / 5' 1	97 / 214	16 AUG 1997	24	FLEURY LOIRET, FLEURY (FRA)	32	
38	LOIDI ETXANIZ June	LB	Right	1.80 / 5' 1	75 / 165	25 APR 2000	22	BERA BERA, SAN SEBASTIAN (ESP)	5	
41	WIGGINS SANCHO Nicole	GK	Right	1.78 / 5' 1	70 / 154	9 AUG 2000	21	BM GRANOLLERS, GRANOLLERS (ES)	4	
45	AALLA ROTAECHÉ Maddi	GK	Right	1.73 / 5' 8	76 / 168	1 JAN 1997	25	BERA BERA, SAN SEBASTIAN (ESP)		
47	VALERO JODAR Sara	P	Right	1.73 / 5' 8	69 / 152	3 FEB 1998	24	AD DIJON, DIJON (FRA)		
53	MBENGUE RODRIGUEZ Seynabou	RB	Left	1.88 / 6' 2	74 / 163	14 OCT 1998	23	BM REMUDAS, GRAN CANARIAS (ESP)	5	
57	VALDIVIA MONSERRAT Paula Maria	RW	Left	1.66 / 5' 5	62 / 137	23 DEC 1995	26	CHAMBRAY, CHAMBRAY LES TOURS (	30	
64	GASCO ARRANZ Clara	RW	Left	1.74 / 5' 9	70 / 154	27 MAY 2000	22	C. BM. ELCHE, ELCHE (ESP)	2	
67	ALVAREZ TORRADO Elba	RB	Left	1.70 / 5' 7	64 / 141	26 MAY 2001	21	BM AULA, VALLADOLID (ESP)		
				<b>Team averages</b>	1.74 / 5' 9	72.0 / 159	23.6		8.9	

#### Uniform Color (Shirts - Shorts)

1st	Red	Blue
2nd	White	White

Coach	ALVAREZ ARRUTI Imanol
Coach	MARTINEZ MARTINEZ Jorge
Coach	PRADES PONS Jose Ignacio
Physiotherapist	NAVARRO RIBERA Maria

#### LEGEND

<b>B</b> Both Handed	<b>B</b> Back	<b>CB</b> Centre Back	<b>FP</b> Joueur
<b>GK</b> Goalkeeper	<b>Int.</b> International	<b>L</b> Left Handed	<b>LB</b> Left Back
<b>LW</b> Left Wing	<b>No.</b> Uniform Number	<b>P</b> Pivot	<b>Pos</b> Position
<b>R</b> Right Handed	<b>RB</b> Right Back	<b>RW</b> Right Wing	<b>W</b> Wing



## Team Roster

As of SUN 26 JUN 2022 at 14:36

### MKD - North Macedonia

No.	Name	Pos	L/R	Height m/ ft in	Weight kg / lbs	Date of Birth	Age	Club	Int. Matches Played	Int. G. Scored
12	CHURLINOVSKA Matea			1.73 / 5' 8	83 / 183	6 DEC 2005	16			
13	KOLOVSKA Aleksandra			1.73 / 5' 8	76 / 168	23 FEB 2004	18			
14	DJATEVSKA Ivana			1.80 / 5' 11	72 / 159	13 APR 2003	19			
15	JANKULOVSKA Marija			1.75 / 5' 9	66 / 146	2 NOV 2005	16			
16	JOVANOVSKA Marija			1.80 / 5' 11	83 / 183	30 AUG 2004	17			
17	DUKOSKA Teodora			1.72 / 5' 8	63 / 139	10 MAY 2004	18			
23	JANKULOVSKA Angela			1.77 / 5' 11	75 / 165	27 JUL 2002	19			
24	KOCEVA Bojana			1.67 / 5' 6	65 / 143	29 JUN 2004	18			
28	MINOVSKA Sara			1.64 / 5' 5	60 / 132	14 JUN 2002	20			
30	KIPRIJANOVSKA Jovana			1.84 / 6' 0	76 / 168	30 DEC 2001	20			
31	SEDLOSKA Andrea			1.83 / 6' 0	75 / 165	16 MAR 2003	19			
32	ARSENIEVSKA Ivana			1.75 / 5' 9	62 / 137	8 DEC 2003	18			
43	RIZOSKA Emilijana			1.64 / 5' 5	55 / 121	21 MAY 2005	17			
71	STEFANOVSKA Sara			1.72 / 5' 8	69 / 152	11 JAN 2005	17			
90	KOCEVA Borjana			1.72 / 5' 8	68 / 150	29 JUN 2004	18			
91	MLADENOVSKA Iva			1.80 / 5' 11	67 / 148	14 JAN 2007	15			
<b>Team averages</b>				1.74 / 5' 9	69.7 / 154		17.8			

Coach **DAMCHEVSKA Julijana**  
 Coach **ANDREJEVA Tanja**  
 Physiotherapist **ANDONOVSKA Katerina**

#### LEGEND

<b>B</b> Both Handed	<b>B</b> Back	<b>CB</b> Centre Back	<b>FP</b> Joueur
<b>GK</b> Goalkeeper	<b>Int.</b> International	<b>L</b> Left Handed	<b>LB</b> Left Back
<b>LW</b> Left Wing	<b>No.</b> Uniform Number	<b>P</b> Pivot	<b>Pos</b> Position
<b>R</b> Right Handed	<b>RB</b> Right Back	<b>RW</b> Right Wing	<b>W</b> Wing
-			



## Team Roster

As of SUN 26 JUN 2022 at 14:36

### POR - Portugal

No.	Name	Pos	L/R	Height m/ ft in	Weight kg / lbs	Date of Birth	Age	Club	Int. Matches	Int. G.
									Played	Scored
1	FIGUEIRA DE GOIS Isabel Cristina	GK	Right	1.79 / 5' 11"	84 / 185	10 OCT 1995	26	Neckarsulmer Sport-Union, Germany (GE)	66	
6	NUNES MONTEIRO Carolina	LW	Right	1.68 / 5' 6"	65 / 143	8 OCT 1998	23	Alavarium/Love Tiles, Aveiro (POR)	16	
7	RODRIGUES SABINO Bebiana Catari	P	Right	1.75 / 5' 9"	73 / 161	15 NOV 1986	35	Colégio Gaia, Gaia (POR)	124	
12	ROSA Matilde	GK	Right	1.74 / 5' 9"	87 / 192	8 JUL 2005	16	Gil Eanes, Lagos (POR)		
16	VARGAS FERREIRA Jessica Romina	GK	Right	1.80 / 5' 11"	75 / 165	11 OCT 1996	25	Clermont A. Metropole, France (FRA)	44	
18	BRITO Mariana			1.74 / 5' 9"	67 / 148	20 JUN 2003	19			
34	RESENDE REBELO Luciana	RB	Left	1.86 / 6' 1"	75 / 165	25 JUL 2005	16	Maiastars, Maia (POR)		
36	FAGUNDES MORAIS Margarida	P	Right	1.70 / 5' 7"	62 / 137	11 JUL 2002	19	ARC Alpendorada, Alpendorada (POR)		
38	PIRES Joana Rafaela	LW	Right	1.69 / 5' 7"	70 / 154	23 MAR 2003	19	SIM Porto Salvo, Oeiras (POR)		
42	BENTO DE CAMPOS Rita	P	Right	1.84 / 6' 0"	93 / 205	21 MAR 2002	20	SL Benfica, Lisboa (POR)	1	
55	DUARTE Maria	RW	Left	1.60 / 5' 3"	65 / 143	16 FEB 2000	22	Madeira SAD, Funchal (POR)	4	
66	COSTA Mariana									
77	MINCIUNA Mihaela Oana	CB	Right	1.74 / 5' 9"	69 / 152	17 APR 1999	23	SL Benfica, Lisboa (POR)	8	
81	CLAUDINO FIGUEIREDO Carmen Fili	LB	Right	1.77 / 5' 11"	65 / 143	3 JAN 2005	17	Gil Eanes, Lagos (POR)	3	
88	DUARTE Neide	CB	Right	1.62 / 5' 4"	68 / 150	22 MAR 1998	24	Madeira SAD, Funchal (POR)		
99	GOMES UNJANQUE Maria João	LB	Right	1.76 / 5' 9"	83 / 183	11 FEB 2003	19	SL Benfica, Lisboa (POR)	4	
<b>Team averages</b>									19.3	

#### Uniform Color (Shirts - Shorts)

1st	Red	Green
2nd	White	Red

Coach	LOUREIRO BORGES Serafim José
Coach	SOARES DAVID José António
Coach	COUTO DE SOUSA Tiago Constantino
Doctor	QUEIROZ RODRIGUES Paulo Alexandre
Physiotherapist	FERREIRA GOMES VAZ Cláudia Raquel

#### LEGEND

<b>B</b> Both Handed	<b>B</b> Back	<b>CB</b> Centre Back	<b>FP</b> Joueur
<b>GK</b> Goalkeeper	<b>Int.</b> International	<b>L</b> Left Handed	<b>LB</b> Left Back
<b>LW</b> Left Wing	<b>No.</b> Uniform Number	<b>P</b> Pivot	<b>Pos</b> Position
<b>R</b> Right Handed	<b>RB</b> Right Back	<b>RW</b> Right Wing	<b>W</b> Wing





## Team Roster

As of SUN 26 JUN 2022 at 14:36

### SRB - Serbia

No.	Name	Pos	L/R	Height m/ ft in	Weight kg / lbs	Date of Birth	Age	Club	Int. Matches Played	Int. G. Scored
1	SIMIC Marija	GK	Right	1.79 / 5' 11"	72 / 159	21 FEB 2000	22	Bekament BB, Arandjelovac (SRB)		
2	RADEVIC Dunja	RW	Left	1.83 / 6' 0"	77 / 170	25 NOV 2005	16	Metalac, Kraljevo (SRB)		
4	MIJAILOVIC Lana			1.79 / 5' 11"	77 / 170	21 MAY 2002	20			
5	CETKOVIC Natasa	RW	Left	1.74 / 5' 9"	65 / 143	22 DEC 2005	16	Srem, Sremska Mitrovica (SRB)		
6	OBRENOVIC Una			1.84 / 6' 0"	77 / 170	27 DEC 2003	18			
7	VUKAJLOVIC Aleksandra	CB	Right	1.81 / 5' 11"	75 / 165	7 JUN 1997	25	Erd, Erd (HUN)	32	
8	INDIC Helena	RB	Left	1.68 / 5' 6"	60 / 132	28 SEP 2003	18	Radnicki, Kragujevac (SRB)		
9	SUKUR Sma	RW	Left	1.79 / 5' 11"	70 / 154	11 APR 2000	22	Jagodina, Jagodina (SRB)		
10	BOGUNOVIC Isidora	LW	Right	1.79 / 5' 11"	70 / 154	23 AUG 2000	21	Crvena Zvezda, Beograd (SRB)		
12	DURASINOVIC Jelena	GK	Right	1.72 / 5' 8"	65 / 143	26 MAR 1998	24	Jaroslav, Jaroslav (POL)	2	
13	JOVANOVIC Marija			1.77 / 5' 11"	70 / 154	31 MAR 1995	27			
14	NUKOVIC Edit	P	Right	1.86 / 6' 1"	80 / 176	1 AUG 1997	24	Union Halle Neustadt, Halle (GER)		
15	VELICKOVIC Teodora	CB	Right	1.69 / 5' 7"	60 / 132	28 APR 2001	21	Radnicki, Kragujevac (SRB)		
22	JOVOVIC Jovana	LB	Right	1.85 / 6' 1"	80 / 176	4 DEC 2001	20	Budaors, Budaors (HUN)	23	
30	TABAK Dunja	LB	Right	1.75 / 5' 9"	70 / 154	29 JUN 2001	21	Zeleznicar, Indija (SRB)		
31	BOJICIC Katarina	P	Right	1.75 / 5' 9"	65 / 143	13 MAR 1998	24	Jagodina, Jagodina (SRB)	1	
				<b>Team averages</b>	1.78 / 5' 11"	70.8 / 156	21.2		14.5	

#### Uniform Color (Shirts - Shorts)

1st	Red	Red
2nd	White	White

Assistant Coach	JOVANOVIC Branka
Assistant Coach	BREGAR Uros
Assistant Coach	MARKOV Dragan
Assistant Coach	NOVAKOVIC Jovan
Physiotherapist	MILOSEV Vladimir

#### LEGEND

<b>B</b> Both Handed	<b>B</b> Back	<b>CB</b> Centre Back	<b>FP</b> Joueur
<b>GK</b> Goalkeeper	<b>Int.</b> International	<b>L</b> Left Handed	<b>LB</b> Left Back
<b>LW</b> Left Wing	<b>No.</b> Uniform Number	<b>P</b> Pivot	<b>Pos</b> Position
<b>R</b> Right Handed	<b>RB</b> Right Back	<b>RW</b> Right Wing	<b>W</b> Wing



## Team Roster

As of SUN 26 JUN 2022 at 14:36

### TUN - Tunisia

No.	Name	Pos	L/R	Height m/ ft in	Weight kg / lbs	Date of Birth	Age	Club	Int. Matches Played	Int. G. Scored
1	GDOURA Omaima			1.71 / 5' 7	62 / 137	26 APR 1996	26			
3	BEN AMMAR Rania			1.74 / 5' 9	85 / 187	14 SEP 1995	26			
5	BEN ABDALLAH Aya			1.68 / 5' 6	67 / 148	19 AUG 1997	24			
7	BOURI Fatma			1.79 / 5' 1	71 / 157	29 JAN 1993	29			
10	HAMROUNI Amal			1.65 / 5' 5	60 / 132	16 JUN 1995	27			
13	MOUEDEB Jawaher			1.76 / 5' 9	70 / 154	17 SEP 1996	25			
16	OMRANI Fadia			1.72 / 5' 8	68 / 150	27 FEB 1984	38			
17	JOUINI Chaima			1.75 / 5' 9	78 / 172	2 JUL 1996	25			
21	HACHANA EP KERKENI Sondes			1.72 / 5' 8	60 / 132	7 SEP 1996	25			
22	GHERISSI Elhem			1.70 / 5' 7	70 / 154	5 JUL 1991	30			
29	MASRI Aya			1.68 / 5' 6	60 / 132	29 MAY 2000	22			
32	ZELFANI Nada			1.75 / 5' 9	65 / 143	11 NOV 2000	21			
33	MKADEM Roa			1.78 / 5' 1	75 / 165	9 APR 2000	22			
88	AOUIJ Fadwa			1.74 / 5' 9	70 / 154	23 FEB 2001	21			
94	REJEB Saida			1.77 / 5' 1	65 / 143	21 MAR 1994	28			
98	BELHADJ Soumaya			1.71 / 5' 7	61 / 134	30 SEP 1998	23			
<b>Team averages</b>				1.73 / 5' 8	67.9 / 150		25.8			

Coach **BEN AMOR Moez**  
 Coach **GRANDI Lotfi**  
 Physiotherapist **FEZZANI EP ABASSI Rania**

#### LEGEND

<b>B</b> Both Handed	<b>B</b> Back	<b>CB</b> Centre Back	<b>FP</b> Joueur
<b>GK</b> Goalkeeper	<b>Int.</b> International	<b>L</b> Left Handed	<b>LB</b> Left Back
<b>LW</b> Left Wing	<b>No.</b> Uniform Number	<b>P</b> Pivot	<b>Pos</b> Position
<b>R</b> Right Handed	<b>RB</b> Right Back	<b>RW</b> Right Wing	<b>W</b> Wing
-			



## Team Roster

As of SUN 26 JUN 2022 at 14:36

### TUR - Turkiye

No.	Name	Pos	L/R	Height m/ ft in	Weight kg / lbs	Date of Birth	Age	Club	Int. Matches Played	Int. G. Scored
2	KARACAM Beyza					15 DEC 2000	21			
7	OZBOLLUK Merve					12 SEP 1994	27			
9	ISKIT Asli					7 DEC 1993	28			
10	AYDIN Elif Sila					11 APR 1996	26			
14	GOKTEPE AKGUN Nurceren					20 JUN 1992	30			
17	TURKOGLU Beyza Irem					4 FEB 1997	25			
18	SOZMEN Ece					19 JAN 1994	28			
21	YILMAZ Betul					31 OCT 1988	33			
22	GOKER Yaren Berfe					5 NOV 1999	22			
23	SAHIN Yasemin					25 JUN 1988	34			
52	CALISKAN Neslihan					29 JUL 1997	24			
55	KARA Aysenur					24 JUN 1999	23			
58	DURDU Merve					15 APR 1996	26			
77	KUCUKYILDIZ Fatma					30 SEP 1992	29			
87	GOKDEMIR Emine					1 FEB 2003	19			
92	DEMIRCELEN Ceren					23 FEB 1992	30			
<b>Team averages</b>								26.6		

Coach **BUCESCHI Costica**  
Coach **INCI Mehmet Serkan**

#### LEGEND

<b>B</b> Both Handed	<b>B</b> Back	<b>CB</b> Centre Back	<b>FP</b> Joueur
<b>GK</b> Goalkeeper	<b>Int.</b> International	<b>L</b> Left Handed	<b>LB</b> Left Back
<b>LW</b> Left Wing	<b>No.</b> Uniform Number	<b>P</b> Pivot	<b>Pos</b> Position
<b>R</b> Right Handed	<b>RB</b> Right Back	<b>RW</b> Right Wing	<b>W</b> Wing
-			



## Brackets

As of WED 6 JUL 2022 at 15:44

### Semi-finals

### Finals

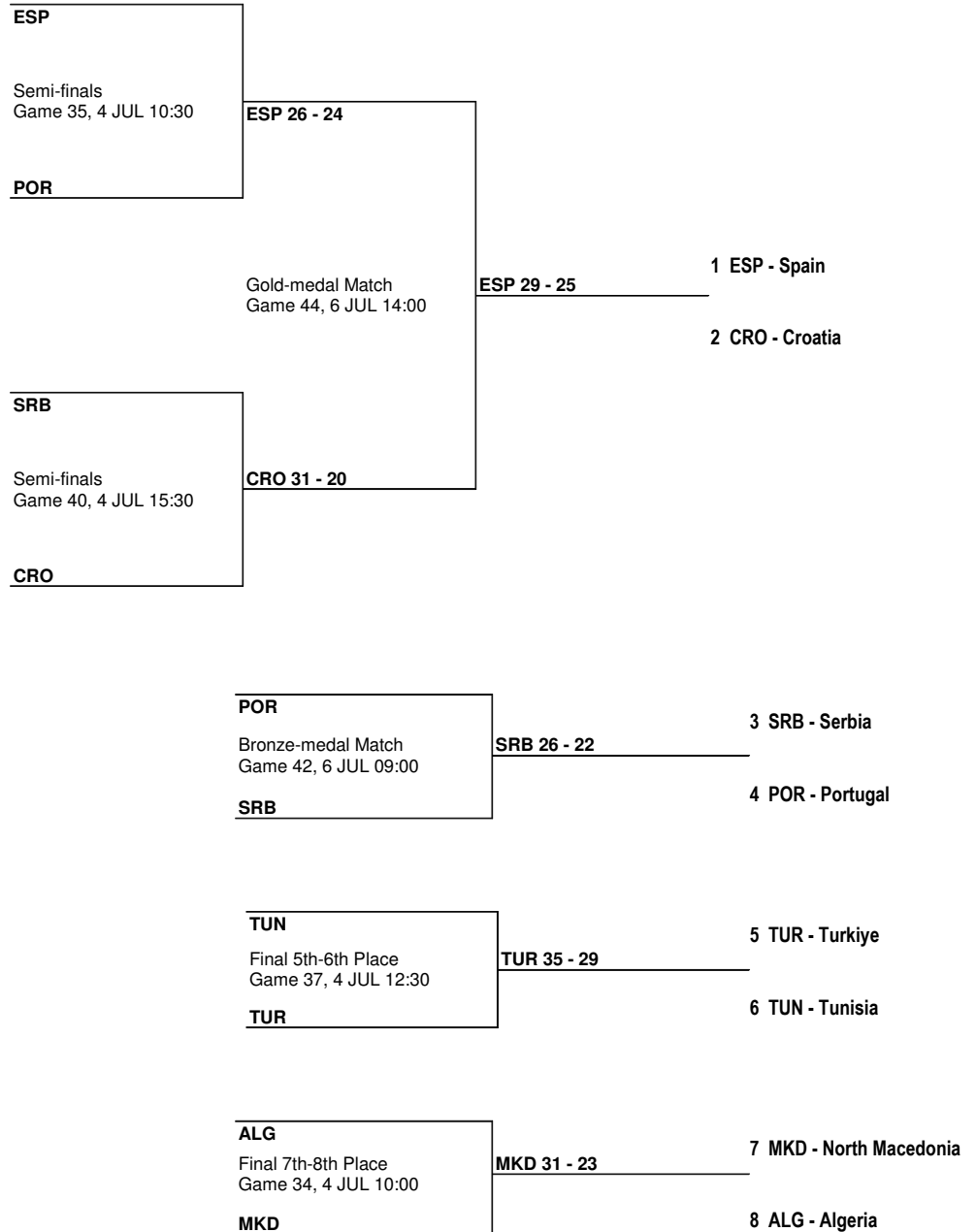



## Pool standings

As of SAT 2 JUL 2022 at 20:48

Group A						Matches				Goals			
Rank		ESP	CRO	TUN	ALG	Played	Won	Ties	Lost	For	Against	Diff.	Class. Points
1	ESP	---	31 - 23	28 - 21	26 - 20	3	3	0	0	85	64	21	6
2	CRO	23 - 31	---	28 - 26	31 - 21	3	2	0	1	82	78	4	4
3	TUN	21 - 28	26 - 28	---	20 - 19	3	1	0	2	67	75	-8	2
4	ALG	20 - 26	21 - 31	19 - 20	---	3	0	0	3	60	77	-17	0

Group B						Matches				Goals			
Rank		SRB	POR	TUR	MKD	Played	Won	Ties	Lost	For	Against	Diff.	Class. Points
1	SRB	---	21 - 20	31 - 26	26 - 18	3	3	0	0	78	64	14	6
2	POR	20 - 21	---	30 - 26	19 - 17	3	2	0	1	69	64	5	4
3	TUR	26 - 31	26 - 30	---	34 - 27	3	1	0	2	86	88	-2	2
4	MKD	18 - 26	17 - 19	27 - 34	---	3	0	0	3	62	79	-17	0

## Match Results

Date	Start Time	Phase	Match	Teams	Result
THU 30 JUN	12:00	Preliminary Group B	10	MKD - TUR	27 - 34
THU 30 JUN	14:00	Preliminary Group B	12	SRB - POR	21 - 20
THU 30 JUN	16:00	Preliminary Group A	14	ESP - ALG	26 - 20
THU 30 JUN	19:00	Preliminary Group A	16	TUN - CRO	26 - 28
FRI 1 JUL	12:00	Preliminary Group B	18	TUR - POR	26 - 30
FRI 1 JUL	14:15	Preliminary Group B	20	MKD - SRB	18 - 26
FRI 1 JUL	17:00	Preliminary Group A	22	ALG - CRO	21 - 31
FRI 1 JUL	19:15	Preliminary Group A	24	ESP - TUN	28 - 21
SAT 2 JUL	12:00	Preliminary Group B	26	TUR - SRB	26 - 31
SAT 2 JUL	14:15	Preliminary Group B	28	POR - MKD	19 - 17
SAT 2 JUL	17:00	Preliminary Group A	30	ALG - TUN	19 - 20
SAT 2 JUL	19:15	Preliminary Group A	32	CRO - ESP	23 - 31



THU 30 JUN 2022

Results

Start Time 17:15

Game Duration: 01:31

ESP 26 vs 20 ALG  
(14-9) (12-11)

Referees: Metodija ILIEVSKI (MKD) Mihajlo ILIEVSKI (MKD)

ESP - Spain

Players		Shots								Punishment			
No.	Name	G / S	%	6m	Wing	9m	7m	FB	BT	YC	2Min	RC	BC
6	CAMPOS COSTA Carmen (C)	6/7	86	4/4		1/1	1/2						
7	ARROJERIA Esther	2/2	100	2/2						1			
13	HERNANDEZ SELVA Laura	0/2	0	0/1			0/1						
23	SPUGNINI SANTOME Alba Chiara	2/2	100	1/1				1/1					
29	GOMES DA COSTA Maria	0/2	0	0/1		0/1				1			
31	VEGUE I PENNA Ona	3/5	60	0/2	2/2		1/1						
32	CUADRADO SANCHEZ Elena	1/3	33	1/3									
33	GASSAMA CISSOKHO Kaba												
38	LOIDI ETXANIZ June										1		
41	WIGGINS SANCHO Nicole												
45	AALLA ROTAECHE Maddi												
47	VALERO JODAR Sara	1/1	100	1/1									
53	MBENGUE RODRIGUEZ Seynabou	1/2	50	1/2									
57	VALDIVIA MONSERRAT Paula Maria	7/8	88	3/3	2/2	0/1		2/2					
64	GASCO ARRANZ Clara	1/2	50	0/1	1/1			0/1					
67	ALVAREZ TORRADO Elba	2/3	67	2/3							1		
<b>Bench/Team</b>													
<b>Totals</b>		26/39	67	15/23	5/5	1/3	2/4	3/4		1	3		

Goalkeepers		Saves							
No.	Name	S / S	%	6m	Wing	9m	7m	FB	BT
41	WIGGINS SANCHO Nicole								
45	AALLA ROTAECHE Maddi	10/30	33	3/13	1/4	5/9	0/1	1/3	
<b>Totals</b>		10/30	33	3/13	1/4	5/9	0/1	1/3	

ALG - Algeria

Players		Shots								Punishment			
No.	Name	G / S	%	6m	Wing	9m	7m	FB	BT	YC	2Min	RC	BC
1	GABOUR Naima												
2	AROUDJ Leila												
5	AMRANI Nassima										1		
7	HAIMER Fatiha	2/5	40	1/3				1/2					
8	ZAZAI Sabrina	3/5	60		2/4		1/1						
9	YELLES Loudmila Manel	3/4	75	3/3		0/1							
10	DJABOUR Waffya	1/1	100	1/1									
11	TAIBI Tasnime Shanez	1/2	50	1/2									
13	MAKHLOUFI Kenza	3/5	60		1/1	1/2		1/2			1		
19	BELOUCHARANI Feriel	1/1	100	1/1							1		
22	SALHI Tinhinane												
23	DERRADJ Imen	3/6	50	1/2		2/4							
26	ZOUAOUI Sylia												
27	AZZI Sarah	3/4	75	2/2		1/2							
31	BOUKAABENE Meriem	0/2	0	0/1		0/1							
33	BENABDELHAFID Nadia												
<b>Bench/Team</b>													
<b>Totals</b>		20/35	57	10/15	3/5	4/10	1/1	2/4			3		

Goalkeepers		Saves							
No.	Name	S / S	%	6m	Wing	9m	7m	FB	BT
1	GABOUR Naima	3/14	21	2/8	0/2		1/2	0/2	
22	SALHI Tinhinane	2/17	12	1/10	0/3	0/1	1/2	0/1	
33	BENABDELHAFID Nadia								
<b>Totals</b>		5/31	16	3/18	0/5	0/1	2/4	0/3	



THU 30 JUN 2022

Start Time 17:15

Game Duration: 01:31

## Results

### RUNNING SCORE

#### ESP - ALG

1st Half		2nd Half	
MBENGUE S.	1 (1') 0	14 (32') 10	BELOUCHRANI
	1 (3') 1 HAIMER F.	CAMPOS C.	15 (32') 10
	1 (4') 2 AZZI S.		15 (33') 11 MAKHLOUFI K.
GASCO C.	2 (5') 2		15 (34') 12 TAIBI T.
	2 (9') 3 AZZI S.		15 (38') 13 MAKHLOUFI K.
	2 (10') 4 HAIMER F.	VALDIVIA P.	16 (41') 13
	2 (13') 5 YELLES L.		16 (42') 14 ZAZAI S.
CAMPOS C.	3 (14') 5	VALERO S.	17 (43') 14
VALDIVIA P.	4 (15') 5	VALDIVIA P.	18 (45') 14
	4 (16') 6 DJABOUR W.		18 (45') 15 MAKHLOUFI K.
VEGUE O.	5 (16') 6		18 (47') 16 DERRADJ I.
VEGUE O.	6 (18') 6	VALDIVIA P.	19 (51') 16
ALVAREZ E.	7 (19') 6	VALDIVIA P.	20 (51') 16
SPUGNINI A.	8 (19') 6	VALDIVIA P.	21 (52') 16
	8 (20') 7 YELLES L.		21 (54') 17 ZAZAI S.
CAMPOS C.	9 (21') 7	ARROJERIA E.	22 (54') 17
VALDIVIA P.	10 (22') 7		22 (55') 18 DERRADJ I.
CUADRADO E.	11 (22') 7	VEGUE O.	23 (56') 18
ALVAREZ E.	12 (24') 7	ARROJERIA E.	24 (57') 18
	12 (25') 8 DERRADJ I.		24 (58') 19 ZAZAI S.
	12 (26') 9 YELLES L.	CAMPOS C.	25 (58') 19
CAMPOS C.	13 (27') 9	SPUGNINI A.	26 (60') 19
CAMPOS C.	14 (30') 9		26 (60') 20 AZZI S.

#### LEGEND

%	Efficiency	(C)	Captain	2Min	2 minutes suspension	6m	6 metre Shots
7m	7 metre Shots	7mS	7 metre Saves	9m	9 metre Shots	BC	Blue Cards
BT	Break Through Shots	FB	Fast Break Shots	G / S	Goals/Shots	No.	Uniform Number
RC	Red Cards	S	Saves	Wing	Wing Shots	YC	Yellow Card



THU 30 JUN 2022

Results

Start Time 19:15

Game Duration: 01:33

TUN 26 vs 28 CRO

(14-17) (12-11)

Referees: Joana Filipa FERREIRA DA SILVA (POR) Lia Barbara DA SILVA PINHERIO (POR)

TUN - Tunisia

No.	Name	Players		Shots						Punishment			
		G / S	%	6m	Wing	9m	7m	FB	BT	YC	2Min	RC	BC
1	GDOURA Omaima												
3	BEN AMMAR Rania												
5	BEN ABDALLAH Aya	2/2	100	2/2							1		
7	BOURI Fatma	1/2	50					1/2			1		
10	HAMROUNI Amal	8/9	89	3/3	1/1	1/1	2/3	1/1					
13	MOUEDEB Jawaher	1/1	100	1/1									
16	OMRANI Fadia												
17	JOUINI Chaima	3/3	100	1/1		2/2					2		
21	HACHANA EP KERKENI Sondes	4/8	50	3/6		0/1	1/1				1		
22	GHERISSI Elhem												
29	MASRI Aya	0/1	0	0/1									
32	ZELFANI Nada												
33	MKADEM Roa	1/1	100	1/1									
88	AOUIJ Fadwa	5/10	50	2/6			1/1	2/3					
94	REJEB Saïda	1/1	100					1/1					
98	BELHADJ Soumaya	0/1	0	0/1									
Bench/Team													
Totals		26/39	67	13/22	1/1	3/4	4/5	5/7			5		

Goalkeepers		Saves							
No.	Name	S / S	%	6m	Wing	9m	7m	FB	BT
1	GDOURA Omaima	3/5	60	2/3	1/1		0/1		
16	OMRANI Fadia	2/11	18	1/5	1/3	0/2	0/1		
33	MKADEM Roa	1/18	6	0/14	0/1		0/2	1/1	
Totals		6/34	18	3/22	2/5	0/2	0/4	1/1	

CRO - Croatia

No.	Name	Players		Shots						Punishment			
		G / S	%	6m	Wing	9m	7m	FB	BT	YC	2Min	RC	BC
1	BESEN Lucija												
6	SENVALD Sara										2	1	
8	POSAVEC Stela	2/4	50	2/4									
19	JAPUNDA Tena	6/8	75	4/5	2/3								
23	PAVLOVIC Katarina	12/13	92	7/8		1/1	4/4						
28	SIMARA Andrea	5/9	56	4/5	1/3			0/1			1		
32	MALEC Ana												
38	BARISIC Tina	2/2	100	1/1		1/1					1		
40	PETIKA Tena	0/2	0	0/1		0/1					1		
47	TUCAKOVIC Antonija												
51	JARAK Lana	1/1	100	1/1									
53	VOJNOVIC Nika												
54	GUSKIC Ema												
58	BEBEK Josipa												
61	TUPEK Mia												
Bench/Team											1		
Totals		28/39	72	19/25	3/6	2/3	4/4	0/1			1	5	1

Goalkeepers		Saves							
No.	Name	S / S	%	6m	Wing	9m	7m	FB	BT
1	BESEN Lucija	0/10	0	0/5	0/1	0/3	0/1		
47	TUCAKOVIC Antonija	8/24	33	5/13		1/1	1/4	1/6	
Totals		8/34	24	5/18	0/1	1/4	1/5	1/6	





THU 30 JUN 2022

Start Time 19:15

Game Duration: 01:33

## Results

## RUNNING SCORE

## TUN - CRO

1st Half		2nd Half	
	0 (4') 1 PAVLOVIC K.	HACHANA S.	15 (32') 17
HAMROUNI A.	1 (4') 1	HAMROUNI A.	16 (34') 17
	1 (6') 2 JAPUNDZA T.		16 (35') 18 JAPUNDZA T.
MKADEM R.	2 (6') 2	AOUIJ F.	17 (36') 18
	2 (7') 3 JAPUNDZA T.		17 (37') 19 SIMARA A.
BEN ABDALLAH A.	3 (7') 3	AOUIJ F.	18 (37') 19
	3 (9') 4 PAVLOVIC K.	REJEB S.	19 (38') 19
	3 (9') 5 JAPUNDZA T.	HAMROUNI A.	20 (41') 19
HAMROUNI A.	4 (10') 5	AOUIJ F.	21 (42') 19
	4 (11') 6 PAVLOVIC K.		21 (43') 20 BARISIC T.
HAMROUNI A.	5 (12') 6	HACHANA S.	22 (44') 20
	5 (13') 7 PAVLOVIC K.		22 (45') 21 BARISIC T.
HAMROUNI A.	6 (15') 7	HACHANA S.	23 (48') 21
	6 (16') 8 POSAVEC S.		23 (49') 22 PAVLOVIC K.
JOUINI C.	7 (16') 8		23 (51') 23 PAVLOVIC K.
	7 (17') 9 JAPUNDZA T.	HACHANA S.	24 (52') 23
	7 (18') 10 SIMARA A.		24 (53') 24 PAVLOVIC K.
JOUINI C.	8 (19') 10		24 (54') 25 JARAK L.
MOUEDEB J.	9 (19') 10		24 (56') 26 PAVLOVIC K.
	9 (19') 11 POSAVEC S.	AOUIJ F.	25 (57') 26
JOUINI C.	10 (20') 11		25 (57') 27 PAVLOVIC K.
	10 (21') 12 PAVLOVIC K.	HAMROUNI A.	26 (60') 27
AOUIJ F.	11 (23') 12		26 (60') 28 PAVLOVIC K.
	11 (24') 13 SIMARA A.		
HAMROUNI A.	12 (24') 13		
	12 (25') 14 PAVLOVIC K.		
BEN ABDALLAH A.	13 (26') 14		
BOURI F.	14 (26') 14		
	14 (27') 15 JAPUNDZA T.		
	14 (28') 16 SIMARA A.		
	14 (29') 17 SIMARA A.		

## LEGEND

%	Efficiency	(C)	Captain	2Min	2 minutes suspension	6m	6 metre Shots
7m	7 metre Shots	7mS	7metre Saves	9m	9 metre Shots	BC	Blue Cards
BT	Break Through Shots	FB	Fast Break Shots	G / S	Goals/Shots	No.	Uniform Number
RC	Red Cards	S	Saves	Wing	Wing Shots	YC	Yellow Card



FRI 1 JUL 2022

Results

Start Time 17:15

Game Duration: 01:35

ALG 21 vs 31 CRO

(8-14) (13-17)

Referees: Marta SA (POR) Vania SA (POR)

ALG - Algeria

No.	Name	Players				Shots					Punishment			
		G / S	%	6m	Wing	9m	7m	FB	BT	YC	2Min	RC	BC	
1	GABOUR Naima													
2	AROUDJ Leila													
5	AMRANI Nassima													
7	HAIMER Fatiha	4/6	67	2/3		1/1		1/2						
8	ZAZAI Sabrina	4/7	57	0/1			4/6							
9	YELLES Loudmila Manel	2/7	29	0/2		2/5					1			
10	DJABOUR Waffya	1/2	50			1/2					1			
11	TAIBI Tasnime Shanez	1/1	100	1/1							1			
13	MAKHLOUFI Kenza	4/7	57	1/3	1/2			2/2				2		
19	BELOUCHRANI Ferial	1/1	100			1/1						1		
22	SALHI Tinhinane													
23	DERRADJ Imen	1/3	33	0/2			1/1							
26	ZOUAOUI Sylia													
27	AZZI Sarah	2/3	67	1/1	1/1	0/1								
31	BOUKAABENE Meriem	1/3	33		0/1	1/2						1		
33	BENABDELHAFID Nadia													
Bench/Team														
Totals		21/40	53	5/13	2/4	6/12	5/7	3/4			1	6		

Goalkeepers		Saves							
No.	Name	S / S	%	6m	Wing	9m	7m	FB	BT
1	GABOUR Naima	4/15	27	2/9		1/1	1/3	0/2	
22	SALHI Tinhinane	5/19	26	2/6	0/2	3/4	0/3	0/4	
33	BENABDELHAFID Nadia	2/8	25	0/3				2/5	
Totals		11/42	26	4/18	0/2	4/5	1/6	2/11	

CRO - Croatia

No.	Name	Players				Shots					Punishment			
		G / S	%	6m	Wing	9m	7m	FB	BT	YC	2Min	RC	BC	
1	BESEN Lucija	1/1	100					1/1						
6	SENVALD Sara	3/4	75	2/3				1/1			1			
8	POSAVEC Stela	1/1	100	1/1								1		
19	JAPUNDA Tena	3/3	100	1/1	1/1			1/1				1		
23	PAVLOVIC Katarina	9/12	75	3/3		1/2	4/5	1/2						
32	MALEC Ana	2/3	67	2/3										
38	BARISIC Tina	0/1	0	0/1										
40	PETIKA Tena	4/10	40	4/7		0/3						2		
47	TUCAKOVIC Antonija													
51	JARAK Lana	5/6	83	0/1	1/1			4/4						
53	VOJNOVIC Nika	1/2	50	1/1				0/1						
54	GUSKIC Ema	1/1	100					1/1				1		
58	BEBEK Josipa	1/1	100				1/1							
61	TUPEK Mia											1		
Bench/Team														
Totals		31/45	69	14/21	2/2	1/5	5/6	9/11			1	6		

Goalkeepers		Saves							
No.	Name	S / S	%	6m	Wing	9m	7m	FB	BT
1	BESEN Lucija	11/26	42	6/9		3/9	2/5	0/3	
47	TUCAKOVIC Antonija	1/7	14	1/3	0/2		0/2		
Totals		12/33	36	7/12	0/2	3/9	2/7	0/3	



FRI 1 JUL 2022

Start Time 17:15

Game Duration: 01:35

## Results

### RUNNING SCORE

#### ALG - CRO

1st Half	2nd Half
0 (3') 1 PAVLOVIC K.	ZAZAI S. 9 (33') 14
0 (5') 2 JARAK L.	9 (34') 15 PETIKA T.
0 (6') 3 BESEN L.	9 (36') 16 PETIKA T.
0 (7') 4 SENVALD S.	HAIMER F. 10 (36') 16
AZZI S. 1 (7') 4	10 (37') 17 PAVLOVIC K.
YELLES L. 2 (10') 4	YELLES L. 11 (38') 17
2 (10') 5 PAVLOVIC K.	11 (39') 18 PAVLOVIC K.
2 (12') 6 PAVLOVIC K.	MAKHLOUFI K. 12 (40') 18
2 (13') 7 PAVLOVIC K.	ZAZAI S. 13 (41') 18
MAKHLOUFI K. 3 (15') 7	13 (42') 19 JAPUNDA T.
3 (17') 8 PAVLOVIC K.	13 (43') 20 SENVALD S.
3 (21') 9 MALEC A.	MAKHLOUFI K. 14 (44') 20
HAIMER F. 4 (21') 9	14 (44') 21 SENVALD S.
MAKHLOUFI K. 5 (23') 9	HAIMER F. 15 (46') 21
TAIBI T. 6 (24') 9	15 (47') 22 PETIKA T.
6 (25') 10 JAPUNDA T.	HAIMER F. 16 (47') 22
6 (26') 11 JARAK L.	16 (48') 23 JAPUNDA T.
ZAZAI S. 7 (26') 11	16 (49') 24 VOJNOVIC N.
7 (27') 12 POSAVEC S.	16 (51') 25 JARAK L.
7 (27') 13 PAVLOVIC K.	16 (52') 26 BEBEK J.
7 (28') 14 PAVLOVIC K.	BELOUCHRANI 17 (53') 26
ZAZAI S. 8 (30') 14	17 (54') 27 MALEC A.
	DJABOUR W. 18 (54') 27
	BOUKAABENE 19 (56') 27
	19 (56') 28 PETIKA T.
	19 (57') 29 JARAK L.
	DERRADJ I. 20 (58') 29
	20 (59') 30 GUSKIC E.
	AZZI S. 21 (59') 30
	21 (60') 31 JARAK L.

#### LEGEND

%	Efficiency	(C)	Captain	2Min	2 minutes suspension	6m	6 metre Shots
7m	7 metre Shots	7mS	7metre Saves	9m	9 metre Shots	BC	Blue Cards
BT	Break Through Shots	FB	Fast Break Shots	G / S	Goals/Shots	No.	Uniform Number
RC	Red Cards	S	Saves	Wing	Wing Shots	YC	Yellow Card



FRI 1 JUL 2022

## Results

Start Time 19:15

Game Duration: 01:22

## ESP 28 vs 21 TUN

(11-8) (17-13)

Referees: Dragana JAKOVLJEVIC (SRB) Daniejla KOVACEVIC (SRB)

## ESP - Spain

No.	Name	Players		Shots						Punishment			
		G / S	%	6m	Wing	9m	7m	FB	BT	YC	2Min	RC	BC
6	CAMPOS COSTA Carmen (C)	2/2	100	1/1			1/1						
7	ARROJERIA Esther	7/12	58	4/8		2/3		1/1		1			
13	HERNANDEZ SELVA Laura	1/2	50	1/2									
23	SPUGNINI SANTOME Alba Chiara	1/1	100	1/1									
29	GOMES DA COSTA Maria	1/3	33			1/3							
31	VEGUE I PENA Ona	3/4	75	1/1	0/1		2/2						
32	CUADRADO SANCHEZ Elena	4/4	100	2/2		1/1		1/1		1			
33	GASSAMA CISSOKHO Kaba	1/2	50	1/1	0/1								
38	LOIDI ETXANIZ June	3/3	100	1/1				2/2		1	1		
41	WIGGINS SANCHO Nicole												
45	AALLA ROTAECHE Maddi												
47	VALERO JODAR Sara	1/2	50	0/1				1/1					
53	MBENGUE RODRIGUEZ Seynabou												
57	VALDIVIA MONSERRAT Paula Maria	1/3	33	1/2				0/1					
64	GASCO ARRANZ Clara	1/2	50	1/1	0/1								
67	ALVAREZ TORRADO Elba	2/4	50	2/4									
Bench/Team													
Totals		28/44	64	16/25	0/3	4/7	3/3	5/6		1	3		

Goalkeepers		Saves							
No.	Name	S / S	%	6m	Wing	9m	7m	FB	BT
41	WIGGINS SANCHO Nicole	9/30	30	8/16	0/6	1/2	0/4	0/2	
45	AALLA ROTAECHE Maddi								
Totals		9/30	30	8/16	0/6	1/2	0/4	0/2	

## TUN - Tunisia

No.	Name	Players		Shots						Punishment			
		G / S	%	6m	Wing	9m	7m	FB	BT	YC	2Min	RC	BC
1	GDOURA Omaira												
3	BEN AMMAR Rania	1/3	33	1/3						2			
5	BEN ABDALLAH Aya	2/2	100		1/1			1/1					
7	BOURI Fatma	4/5	80	1/2	3/3					1			
10	HAMROUNI Amal	2/6	33	1/4			1/2						
13	MOUEDEB Jawaher	2/2	100	1/1	1/1								
16	OMRANI Fadia (C)												
17	JOUINI Chaima	2/4	50	1/2		1/2							
21	HACHANA EP KERKENI Sondes	3/4	75	0/1			3/3						
22	GHERISSI Elhem												
29	MASRI Aya	2/6	33	1/2		0/3		1/1					
32	ZELFANI Nada	2/4	50	1/3	1/1								
33	MKADEM Roa												
88	AOUIJ Fadwa	0/1	0	0/1									
94	REJEB Saïda												
98	BELHADJ Soumaya	1/1	100	1/1									
Bench/Team													
Totals		21/38	55	8/20	6/6	1/5	4/5	2/2			3		

Goalkeepers		Saves							
No.	Name	S / S	%	6m	Wing	9m	7m	FB	BT
1	GDOURA Omaira	0/3	0			0/1	0/1	0/1	
33	MKADEM Roa	10/35	29	5/21	2/2	2/5	0/2	1/5	
Totals		10/38	26	5/21	2/2	2/6	0/3	1/6	



FRI 1 JUL 2022

Start Time 19:15

Game Duration: 01:22

**Results**
**RUNNING SCORE**
**ESP - TUN**

1st Half		2nd Half	
ALVAREZ E.	1 (3') 0	LOIDI J.	12 (31') 8
SPUGNINI A.	2 (6') 0	ARROJERIA E.	13 (32') 8
VALDIVIA P.	3 (7') 0		13 (33') 9 BELHADJ S.
ARROJERIA E.	4 (12') 0	LOIDI J.	14 (33') 9
	4 (13') 1 BOURI F.	GASSAMA K.	15 (34') 9
CAMPOS C.	5 (14') 1	CUADRADO E.	16 (36') 9
	5 (16') 2 BOURI F.		16 (37') 10 HACHANA S.
ARROJERIA E.	6 (17') 2	CUADRADO E.	17 (37') 10
	6 (18') 3 BOURI F.		17 (38') 11 ZELFANI N.
	6 (19') 4 HAMROUNI A.	ALVAREZ E.	18 (39') 11
	6 (21') 5 HAMROUNI A.		18 (40') 12 MOUEDEB J.
	6 (22') 6 ZELFANI N.		18 (41') 13 HACHANA S.
HERNANDEZ L.	7 (24') 6		18 (42') 14 BEN ABDALLAH A.
GASCO C.	8 (26') 6	ARROJERIA E.	19 (43') 14
VEGUE O.	9 (28') 6	ARROJERIA E.	20 (46') 14
	9 (29') 7 BOURI F.		20 (46') 15 BEN AMMAR R.
ARROJERIA E.	10 (29') 7	VEGUE O.	21 (47') 15
	10 (30') 8 MOUEDEB J.	VEGUE O.	22 (48') 15
CUADRADO E.	11 (30') 8	CUADRADO E.	23 (49') 15
			23 (50') 16 HACHANA S.
		VALERO S.	24 (52') 16
			24 (54') 17 MASRI A.
		ARROJERIA E.	25 (55') 17
			25 (56') 18 JOUINI C.
			25 (57') 19 JOUINI C.
		CAMPOS C.	26 (58') 19
			26 (58') 20 MASRI A.
			26 (59') 21 BEN ABDALLAH A.
		GOMES M.	27 (60') 21
		LOIDI J.	28 (60') 21

**LEGEND**

%	Efficiency	(C)	Captain	2Min	2 minutes suspension	6m	6 metre Shots
7m	7 metre Shots	7mS	7 metre Saves	9m	9 metre Shots	BC	Blue Cards
BT	Break Through Shots	FB	Fast Break Shots	G / S	Goals/Shots	No.	Uniform Number
RC	Red Cards	S	Saves	Wing	Wing Shots	YC	Yellow Card



SAT 2 JUL 2022

**Results**

Start Time 17:00

Game Duration: 01:27

**ALG 19 vs 20 TUN**

(9-10) (10-10)

Referees: Metodija ILIEVSKI (MKD) Mihajlo ILIEVSKI (MKD)

**ALG - Algeria**

No.	Name	Players				Shots					Punishment			
		G / S	%	6m	Wing	9m	7m	FB	BT	YC	2Min	RC	BC	
1	GABOUR Naima													
2	AROUDJ Leila													
5	AMRANI Nassima													
7	HAIMER Fatiha	2/2	100	2/2								2		
8	ZAZAI Sabrina	3/5	60	1/1				2/4						
9	YELLES Loudmila Manel	4/11	36	3/4	0/2	1/5								
10	DJABOUR Waffya	0/2	0	0/1		0/1					1	2		
11	TAIBI Tasnime Shanez	3/4	75	2/3		1/1						1		
13	MAKHLOUFI Kenza	7/11	64	2/3	1/1	0/1		4/6						
19	BELOUCHARANI Ferial													
22	SALHI Tinhinane													
23	DERRADJ Imen	0/2	0	0/1		0/1								
26	ZOUAOUI Sylia													
27	AZZI Sarah	0/2	0	0/1		0/1								
31	BOUKAABENE Meriem													
33	BENABDELHAFID Nadia													
<b>Bench/Team</b>														
<b>Totals</b>		19/39	49	10/16	1/3	2/10	2/4	4/6			1	5		

Goalkeepers		Saves							
No.	Name	S / S	%	6m	Wing	9m	7m	FB	BT
1	GABOUR Naima								
22	SALHI Tinhinane	9/29	31	2/10		5/10	1/6	1/3	
33	BENABDELHAFID Nadia								
<b>Totals</b>		10/29	34	3/10		5/10	1/6	1/3	

**TUN - Tunisia**

No.	Name	Players				Shots					Punishment			
		G / S	%	6m	Wing	9m	7m	FB	BT	YC	2Min	RC	BC	
1	GDOURA Omaima													
3	BEN AMMAR Rania	1/1	100	1/1								1		
5	BEN ABDALLAH Ava										1			
7	BOURI Fatma	2/5	40	1/1	0/1			1/3				1		
10	HAMROUNI Amal	4/7	57	0/3		1/1	3/3							
13	MOUEDEB Jawaher													
16	OMRANI Fadia													
17	JOUINI Chaima													
21	HACHANA EP KERKENI Sondes	3/4	75	2/2		1/2						2		
22	GHERISSI Elhem													
29	MASRI Aya	7/13	54	3/4		3/8		1/1						
32	ZELFANI Nada											1		
33	MKADEM Roa													
88	AOUIJ Fadwa	2/4	50	0/1				2/3						
94	REJEB Saida													
98	BELHADJ Soumaya	1/3	33	1/1		0/2						1		
<b>Bench/Team</b>														
<b>Totals</b>		20/37	54	8/13	0/1	5/13	5/6	2/4			1	2	6	

Goalkeepers		Saves							
No.	Name	S / S	%	6m	Wing	9m	7m	FB	BT
1	GDOURA Omaima	0/1	0				0/1		
16	OMRANI Fadia	0/1	0				0/1		
33	MKADEM Roa	13/30	43	5/15	2/3	5/7		1/5	
<b>Totals</b>		13/32	41	5/15	2/3	5/7	0/2	1/5	



SAT 2 JUL 2022

Start Time 17:00

Game Duration: 01:27

## Results

### RUNNING SCORE

1st Half		2nd Half	
MAKHOLOUFI K.	1 (7') 0	9 (33') 11	BOURI F.
	1 (8') 1	10 (33') 11	HAIMER F.
YELLES L.	2 (9') 1	10 (34') 12	MASRI A.
	2 (9') 2	11 (36') 12	HAIMER F.
	2 (12') 3	11 (37') 13	HACHANA S.
ZAZAI S.	3 (12') 3	12 (38') 13	YELLES L.
	3 (13') 4	12 (39') 14	AOUIJ F.
MAKHOLOUFI K.	4 (14') 4	12 (41') 15	AOUIJ F.
	4 (15') 5	12 (43') 16	MASRI A.
MAKHOLOUFI K.	5 (16') 5	12 (46') 17	MASRI A.
	5 (16') 6	13 (49') 17	YELLES L.
	5 (20') 7	13 (50') 18	HACHANA S.
MAKHOLOUFI K.	6 (20') 7	13 (50') 19	MASRI A.
	6 (22') 8	14 (50') 19	ZAZAI S.
TAIBI T.	7 (22') 8	15 (52') 19	MAKHOLOUFI K.
	7 (23') 9	16 (53') 19	YELLES L.
	7 (24') 10	16 (57') 20	MASRI A.
TAIBI T.	8 (26') 10	17 (58') 20	MAKHOLOUFI K.
ZAZAI S.	9 (28') 10	18 (59') 20	TAIBI T.
		19 (60') 20	MAKHOLOUFI K.

### LEGEND

%	Efficiency	(C)	Captain	2Min	2 minutes suspension	6m	6 metre Shots
7m	7 metre Shots	7mS	7 metre Saves	9m	9 metre Shots	BC	Blue Cards
BT	Break Through Shots	FB	Fast Break Shots	G / S	Goals/Shots	No.	Uniform Number
RC	Red Cards	S	Saves	Wing	Wing Shots	YC	Yellow Card



SAT 2 JUL 2022

## Results

Start Time 19:15

Game Duration: 01:19

## CRO 23 vs 31 ESP

(12-18) (11-13)

Referees: Sid Ali HAMIDI (ALG) Youcef BELKHIRI (ALG)

## CRO - Croatia

No.	Name	Shots								Punishment				
		G / S	%	6m	Wing	9m	7m	FB	BT	YC	2Min	RC	BC	
1	BESEN Lucija													
6	SEINVALD Sara	1/2	50	1/1	0/1						1			
8	POSAVEC Stela	8/9	89	8/9										
19	JAPUNDZA Tena	3/5	60	1/2	2/3									
23	PAVLOVIC Katarina	6/10	60	2/2		2/6	2/2			1	1			
28	SIMARA Andrea													
32	MALEC Ana													
38	BARISIC Tina	2/6	33	0/2		2/4								
40	PETIKA Tena	1/6	17	0/1		1/5								
47	TUCAKOVIC Antonija													
51	JARAK Lana	1/2	50						1/2		1			
53	VOJNOVIC Nika													
54	GUSKIC Ema													
58	BEBEK Josipa	0/1	0		0/1									
61	TUPEK Mia	1/1	100	1/1										
Bench/Team											1			
Totals		23/42	55	13/18	2/5	5/15	2/2	1/2			2	3		

Goalkeepers		Saves							
No.	Name	S / S	%	6m	Wing	9m	7m	FB	BT
1	BESEN Lucija								
47	TUCAKOVIC Antonija	6/37	16	1/13	1/6	2/5	2/9	0/4	
Totals		6/37	16	1/13	1/6	2/5	2/9	0/4	

## ESP - Spain

No.	Name	Shots								Punishment				
		G / S	%	6m	Wing	9m	7m	FB	BT	YC	2Min	RC	BC	
6	CAMPOS COSTA Carmen	7/8	88	3/3			4/5							
7	ARROJERIA Esther	1/1	100	1/1							1			
13	HERNANDEZ SELVA Laura	6/9	67		1/2	0/1	3/4	2/2						
23	SPUGNINI SANTOME Alba Chiara	2/2	100	2/2										
29	GOMES DA COSTA Maria	5/8	63	2/2		2/5		1/1		1				
31	VEGUE I PENA Ona	1/2	50		1/1		0/1							
32	CUADRADO SANCHEZ Elena	2/2	100	1/1		1/1					1			
33	GASSAMA CISSOKHO Kaba													
38	LOIDI ETXANIZ June													
41	WIGGINS SANCHO Nicole													
45	AALLA ROTAECHE Maddi													
47	VALERO JODAR Sara	2/2	100	2/2							1			
53	MBENGUE RODRIGUEZ Seynabou													
57	VALDIVIA MONSERRAT Paula Maria	1/3	33	0/1	0/1			1/1						
64	GASCO ARRANZ Clara	4/5	80	1/1	3/4						1			
67	ALVAREZ TORRADO Elba	0/1	0	0/1										
Bench/Team											1			
Totals		31/43	72	12/14	5/8	3/7	7/10	4/4			3	3		

Goalkeepers		Saves							
No.	Name	S / S	%	6m	Wing	9m	7m	FB	BT
41	WIGGINS SANCHO Nicole	8/17	47	1/5	2/3	5/8		0/1	
45	AALLA ROTAECHE Maddi	3/17	18	1/10	0/1	1/3	0/2	1/1	
Totals		11/34	32	2/15	2/4	6/11	0/2	1/2	





SAT 2 JUL 2022

Start Time 19:15

Game Duration: 01:19

## Results

### RUNNING SCORE

#### CRO - ESP

1st Half		2nd Half	
	0 (2') 1 VEGUE O.	JAPUNDA T.	13 (31') 18
JAPUNDA T.	1 (2') 1	PAVLOVIC K.	14 (32') 18
	1 (4') 2 VALERO S.		14 (33') 19 CAMPOS C.
	1 (5') 3 GOMES M.	PAVLOVIC K.	15 (33') 19
	1 (6') 4 GOMES M.		15 (34') 20 GOMES M.
PETIKA T.	2 (7') 4	POSAVEC S.	16 (34') 20
	2 (8') 5 GOMES M.		16 (35') 21 GASCO C.
POSAVEC S.	3 (9') 5	JARAK L.	17 (36') 21
	3 (10') 6 CAMPOS C.	PAVLOVIC K.	18 (38') 21
	3 (11') 7 ARROJERIA E.		18 (39') 22 GASCO C.
	3 (12') 8 HERNANDEZ L.		18 (40') 23 GASCO C.
POSAVEC S.	4 (13') 8	PAVLOVIC K.	19 (40') 23
	4 (14') 9 VALDIVIA P.		19 (41') 24 GOMES M.
POSAVEC S.	5 (15') 9	SEINVALD S.	20 (41') 24
	5 (17') 10 CAMPOS C.		20 (42') 25 CAMPOS C.
JAPUNDA T.	6 (18') 10		20 (47') 26 CAMPOS C.
	6 (18') 11 HERNANDEZ L.	PAVLOVIC K.	21 (48') 26
	6 (19') 12 HERNANDEZ L.		21 (50') 27 CAMPOS C.
POSAVEC S.	7 (19') 12	PAVLOVIC K.	22 (51') 27
	7 (20') 13 GASCO C.		22 (52') 28 HERNANDEZ L.
POSAVEC S.	8 (20') 13	BARISIC T.	23 (52') 28
	8 (21') 14 SPUGNINI A.		23 (57') 29 SPUGNINI A.
POSAVEC S.	9 (21') 14		23 (58') 30 HERNANDEZ L.
	9 (22') 15 CUADRADO E.		23 (60') 31 CAMPOS C.
TUPEK M.	10 (22') 15		
	10 (24') 16 VALERO S.		
	10 (25') 17 HERNANDEZ L.		
BARISIC T.	11 (25') 17		
	11 (28') 18 CUADRADO E.		
POSAVEC S.	12 (29') 18		

#### LEGEND

%	Efficiency	(C)	Captain	2Min	2 minutes suspension	6m	6 metre Shots
7m	7 metre Shots	7mS	7 metre Saves	9m	9 metre Shots	BC	Blue Cards
BT	Break Through Shots	FB	Fast Break Shots	G / S	Goals/Shots	No.	Uniform Number
RC	Red Cards	S	Saves	Wing	Wing Shots	YC	Yellow Card



THU 30 JUN 2022

Results

Start Time 12:00

Game Duration: 01:28

MKD 27 vs 34 TUR

(16-19) (11-15)

Referees: Mustapha DECHE (ALG) Mohamed GUARDA (ALG)

MKD - North Macedonia

Players		Shots								Punishment			
No.	Name	G / S	%	6m	Wing	9m	7m	FB	BT	YC	2Min	RC	BC
12	CHURLINOVSKA Matea												
13	KOLOVSKA Aleksandra												
14	DJATEVSKA Ivana	5/6	83	3/4			1/1	1/1					
15	JANKULOVSKA Marija												
16	JOVANOVSKA Marija												
17	DUKOSKA Teodora	4/9	44	0/2	1/3	1/2	2/2				1		
23	JANKULOVSKA Angela	1/2	50			0/1	1/1						
24	KOCEVA Bojana												
28	MINOVSKA Sara	2/3	67		2/2		0/1						
30	KIPRIJANOVSKA Jovana	6/7	86	3/4		1/1	2/2						
31	SEDLOSKA Andrea												
32	ARSENIEVSKA Ivana	1/2	50	1/1		0/1							
43	RIZOSKA Emilijana	1/2	50	1/1	0/1								
71	STEFANOVSKA Sara												
90	KOCEVA Borjana	4/8	50	3/5	0/1	0/1		1/1			1		
91	MLADENOVSKA Iva	3/6	50	0/1	0/1	3/4							
<b>Bench/Team</b>													
<b>Totals</b>		27/45	60	11/18	3/8	5/10	6/7	2/2			2		

Goalkeepers		Saves							
No.	Name	S / S	%	6m	Wing	9m	7m	FB	BT
12	CHURLINOVSKA Matea	0/3	0	0/2			0/1		
16	JOVANOVSKA Marija	4/35	11	1/9	1/6	2/9	0/2	0/9	
<b>Totals</b>		4/38	11	1/11	1/6	2/9	0/3	0/9	

TUR - Turkiye

Players		Shots								Punishment			
No.	Name	G / S	%	6m	Wing	9m	7m	FB	BT	YC	2Min	RC	BC
2	KARACAM Beyza	3/4	75			3/4							
7	OZBOLLUK Merve												
9	ISKIT Asli	4/7	57	1/3		3/4					1		
10	AYDIN Elif Sila	7/7	100	1/1	2/2			4/4			1		
14	GOKTEPE AKGUN Nurceren	3/3	100	3/3									
17	TURKOGU Bevza Irem	8/9	89	1/1	3/4		1/1	3/3					
18	SOZMEN Ece												
21	YILMAZ Betul									1	1		
22	GOKER Yaren Berfe												
23	SAHIN Yasemin	4/4	100	1/1		1/1	2/2						
52	CALISKAN Neslihan	1/2	50	1/1		0/1					2		
55	KARA Aysenur	1/2	50		0/1			1/1					
58	DURDU Merve	1/1	100	1/1									
77	KUCUKYILDIZ Fatma	2/2	100	1/1				1/1			1		
87	GOKDEMIR Emine	0/1	0		0/1								
92	DEMIRCELEN Ceren												
<b>Bench/Team</b>										3			
<b>Totals</b>		34/42	81	10/12	5/8	7/10	3/3	9/9		4	6		

Goalkeepers		Saves							
No.	Name	S / S	%	6m	Wing	9m	7m	FB	BT
22	GOKER Yaren Berfe								
58	DURDU Merve	14/41	34	6/17	4/7	3/8	1/7	0/2	
<b>Totals</b>		14/41	34	6/17	4/7	3/8	1/7	0/2	



THU 30 JUN 2022

Start Time 12:00

Game Duration: 01:28

**Results**
**RUNNING SCORE**
**MKD - TUR**

1st Half		2nd Half	
KIPRIJANOVSKA	<u>1 (1') 0</u>	16 (32')	20 AYDIN E.
	1 (2') 1 SAHIN Y.	16 (33')	21 DURDU M.
	1 (3') 2 ISKIT A.	16 (34')	22 TURKOGLU B.
DJATEVSKA I.	<u>2 (4') 2</u>	MLADENOVSKA I.	<u>17 (37') 22</u>
	2 (4') 3 KUCUKYILDIZ F.	17 (37')	23 TURKOGLU B.
KOCEVA B.	<u>3 (4') 3</u>	MLADENOVSKA I.	<u>18 (38') 23</u>
DUKOSKA T.	<u>4 (5') 3</u>	18 (39')	24 AYDIN E.
	4 (6') 4 TURKOGLU B.	RIZOSKA E.	<u>19 (39') 24</u>
KIPRIJANOVSKA	<u>5 (9') 4</u>	19 (40')	25 ISKIT A.
	5 (9') 5 GOKTEPE N.	JANKULOVSKA A.	<u>20 (41') 25</u>
DJATEVSKA I.	<u>6 (10') 5</u>	20 (43')	26 KARA A.
	6 (10') 6 TURKOGLU B.	MLADENOVSKA I.	<u>21 (45') 26</u>
	6 (12') 7 TURKOGLU B.	21 (47')	27 AYDIN E.
DUKOSKA T.	<u>7 (12') 7</u>	21 (47')	28 AYDIN E.
DJATEVSKA I.	<u>8 (13') 7</u>	21 (49')	29 AYDIN E.
	8 (13') 8 KARACAM B.	21 (50')	30 KUCUKYILDIZ F.
KOCEVA B.	<u>9 (14') 8</u>	DJATEVSKA I.	<u>22 (51') 30</u>
	9 (15') 9 AYDIN E.	MINOVSKA S.	<u>23 (51') 30</u>
	9 (17') 10 ISKIT A.	23 (52')	31 KARACAM B.
	9 (17') 11 TURKOGLU B.	23 (53')	32 KARACAM B.
	9 (20') 12 SAHIN Y.	MINOVSKA S.	<u>24 (53') 32</u>
DJATEVSKA I.	<u>10 (20') 12</u>	KIPRIJANOVSKA	<u>25 (55') 32</u>
KIPRIJANOVSKA	<u>11 (21') 12</u>	25 (56')	33 AYDIN E.
KOCEVA B.	<u>12 (22') 12</u>	DUKOSKA T.	<u>26 (57') 33</u>
	12 (22') 13 TURKOGLU B.	26 (57')	34 CALISKAN N.
KIPRIJANOVSKA	<u>13 (22') 13</u>	DUKOSKA T.	<u>27 (60') 34</u>
	13 (23') 14 ISKIT A.		
KIPRIJANOVSKA	<u>14 (24') 14</u>		
	14 (24') 15 TURKOGLU B.		
	14 (26') 16 SAHIN Y.		
KOCEVA B.	<u>15 (28') 16</u>		
	15 (28') 17 GOKTEPE N.		
	15 (29') 18 GOKTEPE N.		
ARSENIEVSKA I.	<u>16 (30') 18</u>		
	16 (30') 19 SAHIN Y.		

**LEGEND**

%	Efficiency	(C)	Captain	2Min	2 minutes suspension	6m	6 metre Shots
7m	7 metre Shots	7mS	7metre Saves	9m	9 metre Shots	BC	Blue Cards
BT	Break Through Shots	FB	Fast Break Shots	G / S	Goals/Shots	No.	Uniform Number
RC	Red Cards	S	Saves	Wing	Wing Shots	YC	Yellow Card



THU 30 JUN 2022

**Results**

Start Time 14:15

Game Duration: 01:28

**SRB 21 vs 20 POR**

(13-12) (8-8)

Referees: Boumediene KAHOUADJI (ALG) Mohammed Amine FARSI (ALG)

**SRB - Serbia**

No.	Name	Players		Shots						Punishment			
		G / S	%	6m	Wing	9m	7m	FB	BT	YC	2Min	RC	BC
1	SIMIC Marija												
2	RADEVIC Dunja	0/1	0		0/1								
4	MIJALOVIC Lana												
5	CETKOVIC Natasa	0/1	0		0/1								
6	OBRENOVIC Una	0/2	0	0/2									
7	VUKAJLOVIC Aleksandra	2/10	20	1/8	0/1			1/1			1	1	
8	INDIC Helena												
9	SUKUR Srna	1/1	100		1/1								
10	BOGUNOVIC Isidora	1/3	33	0/2	1/1								
12	DURASINOVIC Jelena												
13	JOVANOVIC Marija	2/3	67	1/2	1/1								
14	NUKOVIC Edita	2/4	50	2/4									
15	VELICKOVIC Teodora	2/3	67				2/3						
22	JOVOVIC Jovana (C)	11/16	69	4/6	1/1	2/2	4/7				1		
30	TABAK Dunia	0/1	0			0/1							
31	BOJICIC Katarina	0/2	0	0/1	0/1								
<b>Bench/Team</b>											1		
<b>Totals</b>		21/47	45	8/25	4/8	2/3	6/10	1/1			1	2	1

Goalkeepers		Saves							
No.	Name	S / S	%	6m	Wing	9m	7m	FB	BT
1	SIMIC Marija	9/17	53	5/11	1/1	2/2		1/3	
12	DURASINOVIC Jelena	11/23	48	7/13	1/3	2/4	1/2	0/1	
<b>Totals</b>		20/40	50	12/24	2/4	4/6	1/2	1/4	

**POR - Portugal**

No.	Name	Players		Shots						Punishment			
		G / S	%	6m	Wing	9m	7m	FB	BT	YC	2Min	RC	BC
1	FIGUEIRA I.												
6	NUNES MONTEIRO Carolina	2/3	67	0/1				2/2					
7	RODRIGUES B. (C)	6/10	60	5/8			1/2				1		
12	ROSA Matilde												
16	VARGAS FERREIRA Jessica Romina												
18	BRITO Mariana												
34	RESENDE REBELO Luciana	1/8	13	1/5		0/3							
36	FAGUNDES MORAIS Margarida	1/1	100	1/1									
38	PIRES Joana Rafaela												
42	BENTO DE CAMPOS Rita												
55	DUARTE Maria	3/6	50	2/5				1/1					
66	COSTA Mariana	1/2	50	1/1	0/1								
77	MINCIUNA Mihaela Oana	1/7	14	0/3	0/1	1/2		0/1			1		
81	CLAUDINO C.	3/6	50	2/4		1/2					1		
88	DUARTE Neide	2/2	100		2/2								
<b>Bench/Team</b>													
<b>Totals</b>		20/45	44	12/28	2/4	2/7	1/2	3/4			3		

Goalkeepers		Saves							
No.	Name	S / S	%	6m	Wing	9m	7m	FB	BT
1	FIGUEIRA I.	18/39	46	12/20	3/7	1/3	2/8	0/1	
12	ROSA Matilde								
16	VARGAS FERREIRA Jessica Romina								
<b>Totals</b>		18/39	46	12/20	3/7	1/3	2/8	0/1	



THU 30 JUN 2022

Start Time 14:15

Game Duration: 01:28

## Results

### RUNNING SCORE

#### SRB - POR

1st Half		2nd Half	
0 (2') 1	RODRIGUES B.	JOVOVIC J. 14 (35') 12	
VUKAJLOVIC A. 1 (3') 1		JOVOVIC J. 15 (35') 12	
1 (3') 2	RESENDE L.	15 (40') 13	CLAUDINO C.
JOVANOVIC M. 2 (4') 2		JOVOVIC J. 16 (40') 13	
VUKAJLOVIC A. 3 (5') 2		16 (41') 14	DUARTE M.
3 (6') 3	RODRIGUES B.	16 (44') 15	FAGUNDES M.
SUKUR S. 4 (6') 3		JOVOVIC J. 17 (45') 15	
4 (7') 4	RODRIGUES B.	17 (46') 16	RODRIGUES B.
VELICKOVIC T. 5 (8') 4		17 (46') 17	NUNES C.
5 (8') 5	DUARTE N.	17 (49') 18	RODRIGUES B.
5 (11') 6	MINCIUNA M.	VELICKOVIC T. 18 (50') 18	
JOVOVIC J. 6 (11') 6		18 (52') 19	DUARTE M.
JOVOVIC J. 7 (13') 6		JOVOVIC J. 19 (54') 19	
BOGUNOVIC I. 8 (14') 6		19 (56') 20	CLAUDINO C.
8 (15') 7	CLAUDINO C.	JOVOVIC J. 20 (58') 20	
NUKOVIC E. 9 (17') 7		NUKOVIC E. 21 (60') 20	
JOVOVIC J. 10 (20') 7			
10 (22') 8	RODRIGUES B.		
10 (25') 9	NUNES C.		
JOVANOVIC M. 11 (28') 9			
11 (28') 10	DUARTE M.		
JOVOVIC J. 12 (29') 10			
12 (30') 11	DUARTE N.		
12 (30') 12	COSTA M.		
JOVOVIC J. 13 (30') 12			

#### LEGEND

%	Efficiency	(C)	Captain	2Min	2 minutes suspension	6m	6 metre Shots
7m	7 metre Shots	7mS	7 metre Saves	9m	9 metre Shots	BC	Blue Cards
BT	Break Through Shots	FB	Fast Break Shots	G / S	Goals/Shots	No.	Uniform Number
RC	Red Cards	S	Saves	Wing	Wing Shots	YC	Yellow Card



FRI 1 JUL 2022

**Results**

Start Time 12:00

Game Duration: 01:26

**TUR 26 vs 30 POR**

(14-12) (12-18)

Referees: Mohammed Amine FARSI (ALG) Boumediene KAHOUADJI (ALG)

**TUR - Turkiye**

Players		Shots								Punishment			
No.	Name	G / S	%	6m	Wing	9m	7m	FB	BT	YC	2Min	RC	BC
2	KARACAM Bevza	4/5	80	1/1	1/1	2/3							
9	ISKIT Asli	3/5	60	1/1		1/2	1/2						
10	AYDIN Elif Sila	3/6	50	2/3	0/2			1/1			1		
14	GOKTEPE AKGUN Nurceren	1/1	100	1/1							1		
17	TURKOGU Bevza Irem	5/7	71	2/2	2/4			1/1			1		
18	SOZMEN Ece	1/1	100	1/1									
21	YILMAZ Betul (C)												
22	GOKER Yaren Berfe												
23	SAHIN Yasemin	3/4	75	2/2		1/1	0/1						
52	CALISKAN Neslihan	2/4	50	1/1		1/3					2		
55	KARA Avsenur												
58	DURDU Merve	1/1	100					1/1					
77	KUCUKYILDIZ Fatma	3/4	75	1/2			2/2						
87	GOKDEMIR Emine												
92	DEMIRCELEN Ceren												
<b>Bench/Team</b>													
<b>Totals</b>		26/38	68	12/14	3/7	5/9	3/5	3/3			5		

Goalkeepers		Saves							
No.	Name	S / S	%	6m	Wing	9m	7m	FB	BT
22	GOKER Yaren Berfe	1/5	20	0/2	1/2	0/1			
58	DURDU Merve	10/36	28	2/13	3/4	3/10	0/4	1/4	1/1
<b>Totals</b>		11/41	27	2/15	4/6	3/11	0/4	1/4	1/1

**POR - Portugal**

Players		Shots								Punishment			
No.	Name	G / S	%	6m	Wing	9m	7m	FB	BT	YC	2Min	RC	BC
6	NUNES MONTEIRO Carolina	1/2	50					1/1	0/1				
7	RODRIGUES B. (C)	9/11	82	2/3	1/2		4/4	2/2					
12	ROSA Matilde												
16	VARGAS FERREIRA Jessica Romina												
18	BRITO Mariana	1/2	50		1/2						2		
34	RESENDE REBELO Luciana	3/5	60	2/2		1/3							
36	FAGUNDES MORAIS Margarida										1		
38	PIRES Joana Rafaela	1/1	100	1/1									
42	BENTO DE CAMPOS Rita												
55	DUARTE Maria	2/4	50	1/2		1/2							
66	COSTA Mariana	3/4	75	2/2		1/2							
77	MINCIUNA Mihaela Oana	8/10	80	5/7		3/3							
81	CLAUDINO C.	2/4	50			2/4							
88	DUARTE Neide	0/5	0		0/4			0/1					
<b>Bench/Team</b>													
<b>Totals</b>		30/48	63	13/17	2/8	8/14	4/4	3/4	0/1		3		

Goalkeepers		Saves							
No.	Name	S / S	%	6m	Wing	9m	7m	FB	BT
12	ROSA Matilde	2/4	50	0/1	1/2	1/1			
16	VARGAS FERREIRA Jessica Romina	8/32	25	2/13	3/5	2/7	1/4	0/3	
<b>Totals</b>		10/36	28	2/14	4/7	3/8	1/4	0/3	



FRI 1 JUL 2022

Start Time 12:00

Game Duration: 01:26

## Results

### RUNNING SCORE

1st Half		2nd Half	
TURKOGLU B.	1 (2') 0	14 (31')	13 RESENDE L.
TURKOGLU B.	2 (2') 0	14 (32')	14 PIRES J.
AYDIN E.	3 (3') 0	SOZMEN E.	15 (32') 14
SAHIN Y.	4 (5') 0	15 (33')	15 MINCIUNA M.
4 (6')	1 RESENDE L.	15 (34')	16 MINCIUNA M.
KARACAM B.	5 (6') 1	15 (35')	17 MINCIUNA M.
5 (7')	2 MINCIUNA M.	TURKOGLU B.	16 (36') 17
ISKIT A.	6 (7') 2	16 (36')	18 RODRIGUES B.
SAHIN Y.	7 (9') 2	16 (37')	19 MINCIUNA M.
7 (9')	3 MINCIUNA M.	ISKIT A.	17 (39') 19
7 (10')	4 RODRIGUES B.	17 (40')	20 COSTA M.
7 (11')	5 CLAUDINO C.	AYDIN E.	18 (41') 20
7 (11')	6 CLAUDINO C.	18 (42')	21 MINCIUNA M.
ISKIT A.	8 (12') 6	GOKTEPE N.	19 (43') 21
8 (13')	7 RODRIGUES B.	19 (43')	22 COSTA M.
TURKOGLU B.	9 (14') 7	19 (44')	23 RODRIGUES B.
9 (15')	8 RESENDE L.	19 (46')	24 MINCIUNA M.
KARACAM B.	10 (15') 8	CALISKAN N.	20 (46') 24
AYDIN E.	11 (17') 8	KUCUKYILDIZ F.	21 (48') 24
KARACAM B.	12 (18') 8	TURKOGLU B.	22 (49') 24
12 (21')	9 RODRIGUES B.	22 (50')	25 RODRIGUES B.
CALISKAN N.	13 (26') 9	22 (52')	26 RODRIGUES B.
13 (27')	10 DUARTE M.	KUCUKYILDIZ F.	23 (53') 26
KUCUKYILDIZ F.	14 (29') 10	DURDU M.	24 (54') 26
14 (29')	11 COSTA M.	24 (55')	27 RODRIGUES B.
14 (30')	12 RODRIGUES B.	SAHIN Y.	25 (56') 27
		KARACAM B.	26 (57') 27
		26 (58')	28 DUARTE M.
		26 (59')	29 NUNES C.
		26 (60')	30 BRITO M.

#### LEGEND

%	Efficiency	(C)	Captain	2Min	2 minutes suspension	6m	6 metre Shots
7m	7 metre Shots	7mS	7metre Saves	9m	9 metre Shots	BC	Blue Cards
BT	Break Through Shots	FB	Fast Break Shots	G / S	Goals/Shots	No.	Uniform Number
RC	Red Cards	S	Saves	Wing	Wing Shots	YC	Yellow Card



FRI 1 JUL 2022

Results

Start Time 14:15

Game Duration: 01:26

MKD 18 vs 26 SRB  
(8-10) (10-16)

Referees: Sid Ali HAMIDI (ALG) Youcef BELKHIRI (ALG)

MKD - North Macedonia

No.	Name	G / S	%	Shots					Punishment					
				6m	Wing	9m	7m	FB	BT	YC	2Min	RC	BC	
12	CHURLINOVSKA Matea													
13	KOLOVSKA Aleksandra	0/1	0			0/1						1		
14	DJATEVSKA Ivana													
15	JANKULOVSKA Marija													
16	JOVANOVSKA Marija													
17	DUKOSKA Teodora	5/8	63	2/2	1/2	0/2	1/1	1/1						
23	JANKULOVSKA Angela													
24	KOCEVA Bojana											1		
28	MINOVSKA Sara	1/4	25		0/3			1/1						
30	KIPRIJANOVSKA Jovana	5/7	71	1/1		1/2	3/4					1		
31	SEDLOSKA Andrea	3/7	43	2/3		1/3	0/1					1		
32	ARSENIEVSKA Ivana	3/4	75	0/1		3/3						1		
43	RIZOSKA Emilijana											1		
71	STEFANOVSKA Sara													
90	KOCEVA Borjana	0/3	0	0/3										
91	MLADENOVSKA Iva	1/5	20			1/5								
Bench/Team												1		
Totals		18/39	46	5/10	1/5	6/16	4/6	2/2				1	6	

No.	Name	S / S	%	Saves					
				6m	Wing	9m	7m	FB	BT
12	CHURLINOVSKA Matea								
16	JOVANOVSKA Marija	13/39	33	5/16	4/7	2/9	2/6	0/1	
Totals		13/39	33	5/16	4/7	2/9	2/6	0/1	

SRB - Serbia

No.	Name	G / S	%	Shots					Punishment					
				6m	Wing	9m	7m	FB	BT	YC	2Min	RC	BC	
1	SIMIC Marija													
2	RADEVIC Dunja	1/4	25		1/4									
4	MJAJILOVIC Lana	0/1	0				0/1							
5	CETKOVIC Natasa	2/3	67		2/3							1		
6	OBRENOVIC Una	1/1	100	1/1								1		
7	VUKAJLOVIC Aleksandra	5/7	71	3/3		1/3	1/1					1		
8	INDIC Helena	0/1	0	0/1										
9	SUKUR Srna	0/2	0		0/2									
10	BOGUNOVIC Isidora	1/1	100	1/1										
12	DURASINOVIC Jelena													
13	JOVANOVIC Marija													
14	NUKOVIC Edita	2/5	40	2/5										
15	VELICKOVIC Teodora	1/1	100				1/1							
22	JOVOVIC Jovana	8/11	73	1/2		5/7	1/1	1/1				2		
30	TABAK Dunja	2/3	67			1/1	1/2							
31	BOJICIC Katarina	3/5	60	3/5										
Bench/Team												2		
Totals		26/45	58	11/18	3/9	7/11	4/6	1/1				2	5	

No.	Name	S / S	%	Saves					
				6m	Wing	9m	7m	FB	BT
1	SIMIC Marija	7/15	47	2/7		3/5	2/3		
12	DURASINOVIC Jelena	11/21	52	2/2	3/4	6/10	0/3	0/2	
Totals		18/36	50	4/9	3/4	9/15	2/6	0/2	





FRI 1 JUL 2022

Start Time 14:15

Game Duration: 01:26

## Results

### RUNNING SCORE

#### MKD - SRB

1st Half		2nd Half	
DUKOSKA T.	1 (1') 0	DUKOSKA T.	9 (31') 10
	1 (2') 1 VUKAJLOVIC A.	MINOVSKA S.	10 (31') 10
	1 (3') 2 VUKAJLOVIC A.		10 (33') 11 JOVOVIC J.
KIPRIJANOVSKA	2 (7') 2		10 (37') 12 BOGUNOVIC I.
	2 (8') 3 CETKOVIC N.	KIPRIJANOVSKA	11 (37') 12
	2 (9') 4 NUKOVIC E.	DUKOSKA T.	12 (38') 12
KIPRIJANOVSKA	3 (10') 4		12 (38') 13 OBRENOVIC U.
MLADENOVSKA I.	4 (14') 4	DUKOSKA T.	13 (39') 13
	4 (15') 5 JOVOVIC J.		13 (39') 14 VUKAJLOVIC A.
KIPRIJANOVSKA	5 (16') 5	ARSENIEVSKA I.	14 (40') 14
	5 (17') 6 TABAK D.		14 (41') 15 VUKAJLOVIC A.
	5 (19') 7 TABAK D.	ARSENIEVSKA I.	15 (41') 15
SEDLOSKA A.	6 (19') 7		15 (42') 16 JOVOVIC J.
	6 (20') 8 BOJICIC K.	SEDLOSKA A.	16 (42') 16
	6 (21') 9 CETKOVIC N.		16 (43') 17 BOJICIC K.
	6 (22') 10 BOJICIC K.		16 (45') 18 JOVOVIC J.
KIPRIJANOVSKA	7 (27') 10		16 (48') 19 JOVOVIC J.
ARSENIEVSKA I.	8 (29') 10		16 (49') 20 JOVOVIC J.
			16 (50') 21 RADEVIC D.
			16 (51') 22 JOVOVIC J.
			16 (52') 23 JOVOVIC J.
			16 (53') 24 VUKAJLOVIC A.
		DUKOSKA T.	17 (54') 24
			17 (57') 25 NUKOVIC E.
		SEDLOSKA A.	18 (59') 25
			18 (60') 26 VELICKOVIC T.

#### LEGEND

%	Efficiency	(C)	Captain	2Min	2 minutes suspension	6m	6 metre Shots
7m	7 metre Shots	7mS	7 metre Saves	9m	9 metre Shots	BC	Blue Cards
BT	Break Through Shots	FB	Fast Break Shots	G / S	Goals/Shots	No.	Uniform Number
RC	Red Cards	S	Saves	Wing	Wing Shots	YC	Yellow Card



SAT 2 JUL 2022  
Start Time 12:00  
Game Duration: 01:28

## Results

### TUR 26 vs 31 SRB (14-17) (12-14)

Referees: Mustapha DECHE (ALG) Mohamed GHOUARDA (ALG)

#### TUR - Turkiye

Players		Shots								Punishment			
No.	Name	G / S	%	6m	Wing	9m	7m	FB	BT	YC	2Min	RC	BC
2	KARACAM Bevza	1/3	33			1/2		0/1					
7	OZBOLLUK Merve	4/5	80	2/2		2/3							
9	ISKIT Asli	5/7	71	2/2		2/4		1/1					
10	AYDIN Elif Sila	3/4	75		3/3			0/1					
14	GOKTEPE AKGUN Nurceren	2/2	100	2/2									
17	TURKOGLU Bevza Irem	2/3	67	1/1	0/1			1/1			1		
18	SOZMEN Ece												
21	YILMAZ Betul	2/4	50	1/1		0/1		1/2			1		
22	GOKER Yaren Berfe												
23	SAHIN Yasemin	3/6	50	0/1		1/3	1/1	1/1					
52	CALISKAN Neslihan	2/3	67	1/1		1/2					2		
55	KARA Aysenur	0/1	0					0/1					
58	DURDU Merve												
77	KUCUKYILDIZ Fatma	0/2	0	0/1			0/1				2		
87	GOKDEMIR Emine	1/3	33	0/1	1/2					1	1		
92	DEMIRCELEN Ceren	1/1	100	1/1									
<b>Bench/Team</b>										1			
<b>Totals</b>		26/44	59	10/13	4/6	7/15	1/2	4/8		2	7		

Goalkeepers		Saves							
No.	Name	S / S	%	6m	Wing	9m	7m	FB	BT
22	GOKER Yaren Berfe	1/3	33	0/1	1/2				
58	DURDU Merve	7/36	19	3/19	1/7	3/7	0/2	0/1	
<b>Totals</b>		8/39	21	3/20	2/9	3/7	0/2	0/1	

#### SRB - Serbia

Players		Shots								Punishment			
No.	Name	G / S	%	6m	Wing	9m	7m	FB	BT	YC	2Min	RC	BC
1	SIMIC Marija												
2	RADEVIC Dunja	2/2	100		1/1			1/1					
4	MJAJLOVIC Lana												
5	CETKOVIC Natasa	1/1	100	1/1									
6	OBRENOVIC Una										1		
7	VUKAJLOVIC Aleksandra	2/5	40	2/4		0/1							
8	INDIC Helena												
9	SUKUR Srna	5/6	83	2/2	3/4								
10	BOGUNOVIC Isidora	4/6	67	1/1	3/5								
12	DURASINOVIC Jelena												
13	JOVANOVIC Marija	5/6	83	5/6						1	1		
14	NUKOVIC Edita	3/4	75	3/4							1		
15	VELICKOVIC Teodora	2/2	100				2/2						
22	JOVOVIC Jovana	5/10	50	1/3		4/7					1		
30	TABAK Dunja												
31	BOJICIC Katarina	2/2	100	2/2									
<b>Bench/Team</b>										2			
<b>Totals</b>		31/44	70	17/23	7/10	4/8	2/2	1/1		3	4		

Goalkeepers		Saves							
No.	Name	S / S	%	6m	Wing	9m	7m	FB	BT
1	SIMIC Marija	4/13	31	1/3	1/3	2/5	0/1	0/1	
12	DURASINOVIC Jelena	8/25	32	1/9	0/2	5/9	1/1	1/4	
<b>Totals</b>		12/38	32	2/12	1/5	7/14	1/2	1/5	



SAT 2 JUL 2022

Start Time 12:00

Game Duration: 01:28

## Results

### RUNNING SCORE

1st Half	TUR - SRB	2nd Half
0 (1') 1 VUKAJLOVIC A.	14 (33') 18 JOVANOVIC M.	
OZBOLLUK M. 1 (1') 1	GOKDEMIR E. 15 (33') 18	
AYDIN E. 2 (2') 1	15 (34') 19 JOVOVIC J.	
2 (3') 2 JOVOVIC J.	OZBOLLUK M. 16 (34') 19	
2 (5') 3 NUKOVIC E.	16 (35') 20 SUKUR S.	
SAHIN Y. 3 (5') 3	YILMAZ B. 17 (35') 20	
3 (7') 4 RADEVIC D.	SAHIN Y. 18 (37') 20	
OZBOLLUK M. 4 (7') 4	18 (39') 21 JOVANOVIC M.	
4 (8') 5 RADEVIC D.	18 (39') 22 BOGUNOVIC I.	
4 (9') 6 JOVANOVIC M.	GOKTEPE N. 19 (40') 22	
OZBOLLUK M. 5 (11') 6	19 (40') 23 JOVANOVIC M.	
GOKTEPE N. 6 (12') 6	19 (45') 24 SUKUR S.	
6 (13') 7 VELICKOVIC T.	TURKOGU B. 20 (45') 24	
6 (13') 8 CETKOVIC N.	ISKIT A. 21 (47') 24	
6 (14') 9 JOVOVIC J.	21 (47') 25 NUKOVIC E.	
DEMIRCELEN C. 7 (15') 9	SAHIN Y. 22 (48') 25	
7 (16') 10 VELICKOVIC T.	TURKOGU B. 23 (48') 25	
YILMAZ B. 8 (16') 10	23 (51') 26 BOGUNOVIC I.	
8 (17') 11 JOVOVIC J.	23 (52') 27 BOGUNOVIC I.	
KARACAM B. 9 (18') 11	23 (53') 28 VUKAJLOVIC A.	
9 (19') 12 JOVANOVIC M.	AYDIN E. 24 (55') 28	
9 (20') 13 BOJICIC K.	24 (56') 29 BOGUNOVIC I.	
9 (21') 14 JOVOVIC J.	CALISKAN N. 25 (56') 29	
ISKIT A. 10 (23') 14	25 (57') 30 NUKOVIC E.	
10 (24') 15 BOJICIC K.	AYDIN E. 26 (57') 30	
10 (25') 16 SUKUR S.	26 (58') 31 SUKUR S.	
ISKIT A. 11 (26') 16		
ISKIT A. 12 (27') 16		
ISKIT A. 13 (28') 16		
13 (30') 17 SUKUR S.		
CALISKAN N. 14 (30') 17		

#### LEGEND

%	Efficiency	(C)	Captain	2Min	2 minutes suspension	6m	6 metre Shots
7m	7 metre Shots	7mS	7 metre Saves	9m	9 metre Shots	BC	Blue Cards
BT	Break Through Shots	FB	Fast Break Shots	G / S	Goals/Shots	No.	Uniform Number
RC	Red Cards	S	Saves	Wing	Wing Shots	YC	Yellow Card



SAT 2 JUL 2022

Results

Start Time 14:15

Game Duration: 01:23

**POR 19 vs 17 MKD**  
(13-11) (6-6)

Referees: Mahieddine GHOUL (ALG) Oussama CHERGUI (ALG)

**POR - Portugal**

Players		Shots								Punishment			
No.	Name	G / S	%	6m	Wing	9m	7m	FB	BT	YC	2Min	RC	BC
1	FIGUEIRA I.												
6	NUNES MONTEIRO Carolina	1/5	20	1/2	0/3								
7	RODRIGUES B. (C)	8/10	80	2/3			5/5	1/2					
12	ROSA Matilde												
16	VARGAS FERREIRA Jessica Romina												
18	BRITO Mariana	0/1	0		0/1								
34	RESENDE REBELO Luciana	3/5	60	1/2		2/3					1		
36	FAGUNDES MORAIS Margarida										1		
38	PIRES Joana Rafaela												
42	BENTO DE CAMPOS Rita												
55	DUARTE Maria	1/2	50	1/1		0/1							
66	COSTA Mariana	3/4	75	3/3		0/1							
77	MINCIUNA Mihaela Oana	1/4	25	1/1		0/3					1		
81	CLAUDINO C.	2/4	50	2/3		0/1				1			
88	DUARTE Neide												
<b>Bench/Team</b>													
<b>Totals</b>		19/35	54	11/15	0/4	2/9	5/5	1/2		1	3		

Goalkeepers		Saves							
No.	Name	S / S	%	6m	Wing	9m	7m	FB	BT
1	FIGUEIRA I.	1/11	9	0/4	0/1	1/3	0/3		
12	ROSA Matilde	0/1	0				0/1		
16	VARGAS FERREIRA Jessica Romina	11/17	65	3/5	1/2	6/6	1/3	0/1	
<b>Totals</b>		12/29	41	3/9	1/3	7/9	1/7	0/1	

**MKD - North Macedonia**

Players		Shots								Punishment			
No.	Name	G / S	%	6m	Wing	9m	7m	FB	BT	YC	2Min	RC	BC
12	CHURLINOVSKA Matea												
13	KOLOVSKA Aleksandra	0/1	0	0/1							2		
14	DJATEVSKA Ivana	1/1	100	1/1									
15	JANKULOVSKA Marija												
16	JOVANOVSKA Marija												
17	DUKOSKA Teodora	10/21	48	3/3		1/11	6/7						
23	JANKULOVSKA Angela	1/3	33	1/1		0/2							
24	KOCEVA Bojana										1		
28	MINOVSKA Sara	3/4	75	0/1	2/2			1/1					
30	KIPRIJANOVSKA Jovana										2		
31	SEDLOSKA Andrea	1/3	33	1/1	0/1	0/1							
32	ARSENIEVSKA Ivana	1/6	17	0/1	0/1	1/4							
43	RIZOSKA Emilijana	0/1	0	0/1									
71	STEFANOVSKA Sara (C)												
90	KOCEVA Borjana	0/3	0	0/2	0/1								
91	MLADENOVSKA Iva	0/4	0	0/2		0/2							
<b>Bench/Team</b>										1			
<b>Totals</b>		17/47	36	6/14	2/5	2/20	6/7	1/1		1	5		

Goalkeepers		Saves							
No.	Name	S / S	%	6m	Wing	9m	7m	FB	BT
12	CHURLINOVSKA Matea	4/23	17	0/11	2/2	2/4	0/5	0/1	
16	JOVANOVSKA Marija								
<b>Totals</b>		4/23	17	0/11	2/2	2/4	0/5	0/1	



SAT 2 JUL 2022

Start Time 14:15

Game Duration: 01:23

## Results

### RUNNING SCORE

#### POR - MKD

1st Half		2nd Half	
NUNES C.	1 (1') 0	RODRIGUES B.	14 (32') 11
	1 (2') 1 DJATEVSKA I.	RODRIGUES B.	15 (35') 11
RODRIGUES B.	2 (2') 1		15 (38') 12 MINOVSKA S.
RODRIGUES B.	3 (3') 1		15 (39') 13 DUKOSKA T.
	3 (5') 2 JANKULOVSKA A.		15 (41') 14 DUKOSKA T.
CLAUDINO C.	4 (6') 2	RESENDE L.	16 (49') 14
	4 (7') 3 SEDLOSKA A.		16 (50') 15 DUKOSKA T.
	4 (8') 4 ARSENEVSKA I.	RESENDE L.	17 (50') 15
CLAUDINO C.	5 (9') 4	RESENDE L.	18 (53') 15
	5 (10') 5 DUKOSKA T.	RODRIGUES B.	19 (57') 15
	5 (12') 6 DUKOSKA T.		19 (59') 16 MINOVSKA S.
DUARTE M.	6 (13') 6		19 (60') 17 DUKOSKA T.
RODRIGUES B.	7 (13') 6		
	7 (15') 7 DUKOSKA T.		
COSTA M.	8 (17') 7		
	8 (17') 8 MINOVSKA S.		
RODRIGUES B.	9 (18') 8		
	9 (19') 9 DUKOSKA T.		
RODRIGUES B.	10 (22') 9		
COSTA M.	11 (24') 9		
COSTA M.	12 (25') 9		
	12 (26') 10 DUKOSKA T.		
MINCIUNA M.	13 (28') 10		
	13 (29') 11 DUKOSKA T.		

#### LEGEND

%	Efficiency	(C)	Captain	2Min	2 minutes suspension	6m	6 metre Shots
7m	7 metre Shots	7mS	7metre Saves	9m	9 metre Shots	BC	Blue Cards
BT	Break Through Shots	FB	Fast Break Shots	G / S	Goals/Shots	No.	Uniform Number
RC	Red Cards	S	Saves	Wing	Wing Shots	YC	Yellow Card



MON 4 JUL 2022

**Results**

Start Time 10:30

Game Duration: 01:22

**ESP 26 vs 24 POR**

(12-13) (14-11)

Referees: Mohammed Amine FARSI (ALG) Boumediene KAHOUADJI (ALG)

**ESP - Spain**

Players		Shots							Punishment				
No.	Name	G / S	%	6m	Wing	9m	7m	FB	BT	YC	2Min	RC	BC
6	CAMPOS COSTA Carmen (C)	10/15	67	5/5		1/5	3/4	1/1					
7	ARROJERIA Esther	4/10	40	3/9				1/1					
13	HERNANDEZ SELVA Laura	0/1	0	0/1									
23	SPUGNINI SANTOME Alba Chiara	1/1	100	1/1									
29	GOMES DA COSTA Maria												
31	VEGUE I PENNA Ona	3/3	100	1/1	1/1		1/1						
32	CUADRADO SANCHEZ Elena	3/6	50	3/3	0/1	0/2					2		
33	GASSAMA CISSOKHO Kaba	2/3	67	2/3							1		
38	LOIDI ETXANIZ June												
41	WIGGINS SANCHO Nicole												
45	AALLA ROTAECHÉ Maddi												
47	VALERO JODAR Sara	0/1	0	0/1									
53	MBENGUE RODRIGUEZ Seynabou												
57	VALDIVIA MONSERRAT Paula Maria	1/1	100	1/1									
64	GASCO ARRANZ Clara	0/2	0		0/2								
67	ALVAREZ TORRADO Elba	2/3	67	2/2	0/1						1		
<b>Bench/Team</b>										1			
<b>Totals</b>		26/46	57	18/27	1/5	1/7	4/5	2/2		1	4		

Goalkeepers		Saves							
No.	Name	S / S	%	6m	Wing	9m	7m	FB	BT
41	WIGGINS SANCHO Nicole	4/17	24	1/8	0/1	3/7	0/1		
45	AALLA ROTAECHÉ Maddi	6/17	35	0/6	0/2	6/8	0/1		
<b>Totals</b>		10/34	29	1/14	0/3	9/15	0/2		

**POR - Portugal**

Players		Shots							Punishment				
No.	Name	G / S	%	6m	Wing	9m	7m	FB	BT	YC	2Min	RC	BC
1	FIGUEIRA I.												
6	NUNES MONTEIRO Carolina	1/1	100	1/1									
7	RODRIGUES B. (C)	3/4	75	1/2			2/2				1		
12	ROSA Matilde												
16	VARGAS FERREIRA Jessica Romina												
18	BRITO Mariana	1/1	100		1/1								
34	RESENDE REBELO Luciana	5/7	71	3/3	1/1	1/3							
36	FAGUNDES MORAIS Margarida										1		
38	PIRES Joana Rafaela	1/2	50	1/1	0/1								
42	BENTO DE CAMPOS Rita	1/1	100	1/1									
55	DUARTE Maria	1/5	20	1/1		0/4							
66	COSTA Mariana	0/2	0			0/2							
77	MINCIUNA Mihaela Oana	6/8	75	4/4	1/1	1/3							
81	CLAUDINO C.	5/9	56	1/1		4/8					2		
88	DUARTE Neide												
<b>Bench/Team</b>										1			
<b>Totals</b>		24/40	60	13/14	3/4	6/20	2/2			1	4		

Goalkeepers		Saves							
No.	Name	S / S	%	6m	Wing	9m	7m	FB	BT
1	FIGUEIRA I.	4/7	57	2/4		2/2		0/1	
12	ROSA Matilde	0/6	0	0/4	0/1		0/1		
16	VARGAS FERREIRA Jessica Romina	7/24	29	4/16	2/2	1/2	0/3	0/1	
<b>Totals</b>		11/37	30	6/24	2/3	3/4	0/4	0/2	



MON 4 JUL 2022

## Results

Start Time 10:30

Game Duration: 01:22

### RUNNING SCORE

#### ESP - POR

1st Half	2nd Half
0 (4) 1 RODRIGUES B.	CAMPOS C. 13 (31) 13
VEGUE O. 1 (5) 1	13 (32) 14 MINCIUNA M.
1 (5) 2 MINCIUNA M.	GASSAMA K. 14 (32) 14
1 (5) 3 MINCIUNA M.	14 (34) 15 PIRES J.
1 (5) 4 RESENDE L.	14 (36) 16 CLAUDINO C.
CAMPOS C. 2 (6) 4	CAMPOS C. 15 (36) 16
2 (9) 5 MINCIUNA M.	15 (39) 17 MINCIUNA M.
ALVAREZ E. 3 (10) 5	ARROJERIA E. 16 (39) 17
3 (13) 6 MINCIUNA M.	16 (41) 18 RODRIGUES B.
3 (14) 7 BENTO R.	GASSAMA K. 17 (42) 18
3 (15) 8 CLAUDINO C.	CAMPOS C. 18 (44) 18
SPUGNINI A. 4 (16) 8	CAMPOS C. 19 (46) 18
4 (17) 9 CLAUDINO C.	CAMPOS C. 20 (47) 18
VALDIVIA P. 5 (17) 9	20 (48) 19 RESENDE L.
ALVAREZ E. 6 (18) 9	CAMPOS C. 21 (50) 19
CUADRADO E. 7 (20) 9	21 (50) 20 RESENDE L.
7 (21) 10 DUARTE M.	21 (51) 21 NUNES C.
ARROJERIA E. 8 (21) 10	ARROJERIA E. 22 (53) 21
8 (22) 11 CLAUDINO C.	22 (54) 22 RODRIGUES B.
CUADRADO E. 9 (22) 11	VEGUE O. 23 (54) 22
ARROJERIA E. 10 (24) 11	CAMPOS C. 24 (56) 22
10 (26) 12 BRITO M.	CAMPOS C. 25 (56) 22
10 (27) 13 CLAUDINO C.	25 (57) 23 RESENDE L.
CAMPOS C. 11 (28) 13	25 (60) 24 RESENDE L.
VEGUE O. 12 (29) 13	CUADRADO E. 26 (60) 24

#### LEGEND

%	Efficiency	(C)	Captain	2Min	2 minutes suspension	6m	6 metre Shots
7m	7 metre Shots	7mS	7 metre Saves	9m	9 metre Shots	BC	Blue Cards
BT	Break Through Shots	FB	Fast Break Shots	G / S	Goals/Shots	No.	Uniform Number
RC	Red Cards	S	Saves	Wing	Wing Shots	YC	Yellow Card



MON 4 JUL 2022

**Results**

Start Time 15:30

Game Duration: 01:17

**SRB 20 vs 31 CRO**

(12-16) (8-15)

Referees: Marta SA (POR) Vania SA (POR)

**SRB - Serbia**

Players		Shots								Punishment			
No.	Name	G / S	%	6m	Wing	9m	7m	FB	BT	YC	2Min	RC	BC
1	SIMIC Marija												
2	RADEVIC Dunja												
4	MIJAILOVIC Lana												
5	CETKOVIC Natasa	0/2	0		0/2								
6	OBRENOVIC Una												
7	VUKAJLOVIC Aleksandra	8/12	67	2/2		6/10							
8	INDIC Helena												
9	SUKUR Srna	0/1	0		0/1					1			
10	BOGUNOVIC Isidora	3/4	75		2/2	0/1		1/1					
12	DURASINOVIC Jelena												
13	JOVANOVIC Marija	0/1	0			0/1					2		
14	NUKOVIC Edita	2/2	100	2/2									
15	VELICKOVIC Teodora	0/2	0				0/2						
22	JOVOVIC Jovana (C)	3/6	50	1/1		1/4	1/1						
30	TABAK Dunia	4/6	67	1/2		3/4							
31	BOJICIC Katarina	0/2	0	0/1		0/1					1		
<b>Bench/Team</b>													
<b>Totals</b>		20/38	53	6/8	2/5	10/21	1/3	1/1		1	3		

Goalkeepers		Saves							
No.	Name	S / S	%	6m	Wing	9m	7m	FB	BT
1	SIMIC Marija	6/37	16	0/10	1/6	4/14	1/2	0/5	
12	DURASINOVIC Jelena								
<b>Totals</b>		6/37	16	0/10	1/6	4/14	1/2	0/5	

**CRO - Croatia**

Players		Shots								Punishment			
No.	Name	G / S	%	6m	Wing	9m	7m	FB	BT	YC	2Min	RC	BC
1	BESEN Lucija												
6	SEINVALD Sara	2/2	100	1/1		1/1							
8	POSAVEC Stela (C)	1/1	100	1/1									
19	JAPUNDZA Tena	1/1	100		1/1								
23	PAVLOVIC Katarina	8/12	67	1/1		5/8	1/2	1/1			2		
28	SIMARA Andrea												
32	MALEC Ana												
38	BARISIC Tina	8/11	73	4/5	1/2	2/3		1/1			1		
40	PETIKA Tena	3/7	43	1/1		2/6				1			
47	TUCAKOVIC Antonija												
51	JARAK Lana	7/7	100	1/1	3/3			3/3					
53	VOJNOVIC Nika												
54	GUSKIC Ema	1/1	100	1/1									
58	BEBEK Josipa												
61	TUPEK Mia												
<b>Bench/Team</b>										1			
<b>Totals</b>		31/42	74	10/11	5/6	10/18	1/2	5/5		2	3		

Goalkeepers		Saves							
No.	Name	S / S	%	6m	Wing	9m	7m	FB	BT
1	BESEN Lucija								
47	TUCAKOVIC Antonija	13/33	39	2/8	3/5	7/17	1/2	0/1	
<b>Totals</b>		13/33	39	2/8	3/5	7/17	1/2	0/1	





MON 4 JUL 2022

## Results

Start Time 15:30

Game Duration: 01:17

### RUNNING SCORE

#### SRB - CRO

1st Half	2nd Half
0 (2) 1 PETIKA T.	12 (35) 17 BARISIC T.
0 (4) 2 PETIKA T.	TABAK D. 13 (36) 17
VUKAJLOVIC A. 1 (5) 2	13 (36) 18 JARAK L.
VUKAJLOVIC A. 2 (5) 2	13 (37) 19 JARAK L.
2 (6) 3 BARISIC T.	BOGUNOVIC I. 14 (38) 19
NUKOVIC E. 3 (6) 3	14 (39) 20 BARISIC T.
VUKAJLOVIC A. 4 (7) 3	14 (39) 21 JARAK L.
4 (8) 4 JARAK L.	14 (41) 22 BARISIC T.
VUKAJLOVIC A. 5 (9) 4	VUKAJLOVIC A. 15 (41) 22
5 (9) 5 PAVLOVIC K.	15 (42) 23 BARISIC T.
VUKAJLOVIC A. 6 (10) 5	JOVOVIC J. 16 (43) 23
6 (11) 6 JAPUNDZA T.	16 (45) 24 BARISIC T.
VUKAJLOVIC A. 7 (11) 6	BOGUNOVIC I. 17 (45) 24
7 (11) 7 POSAVEC S.	17 (47) 25 PETIKA T.
7 (12) 8 PAVLOVIC K.	17 (48) 26 JARAK L.
VUKAJLOVIC A. 8 (13) 8	17 (51) 27 SENVALD S.
8 (15) 9 PAVLOVIC K.	17 (52) 28 PAVLOVIC K.
8 (18) 10 PAVLOVIC K.	TABAK D. 18 (53) 28
8 (20) 11 PAVLOVIC K.	18 (54) 29 SENVALD S.
JOVOVIC J. 9 (20) 11	TABAK D. 19 (55) 29
9 (21) 12 BARISIC T.	TABAK D. 20 (58) 29
JOVOVIC J. 10 (21) 12	20 (59) 30 GUSKIC E.
BOGUNOVIC I. 11 (23) 12	20 (60) 31 BARISIC T.
11 (25) 13 JARAK L.	
11 (27) 14 PAVLOVIC K.	
11 (27) 15 JARAK L.	
11 (28) 16 PAVLOVIC K.	
NUKOVIC E. 12 (30) 16	

#### LEGEND

%	Efficiency	(C)	Captain	2Min	2 minutes suspension	6m	6 metre Shots
7m	7 metre Shots	7mS	7metre Saves	9m	9 metre Shots	BC	Blue Cards
BT	Break Through Shots	FB	Fast Break Shots	G / S	Goals/Shots	No.	Uniform Number
RC	Red Cards	S	Saves	Wing	Wing Shots	YC	Yellow Card



WED 6 JUL 2022

## Results

Start Time 14:00

Game Duration: 01:23

### ESP 29 vs 25 CRO (17-13) (12-12)

Referees: Marta SA (POR) Vania SA (POR)

#### ESP - Spain

Players		Shots								Punishment			
No.	Name	G / S	%	6m	Wing	9m	7m	FB	BT	YC	2Min	RC	BC
6	CAMPOS COSTA Carmen (C)	9/11	82	2/4		1/1	6/6						
7	ARROJERIA Esther	6/7	86	5/6				1/1		1			
13	HERNANDEZ SELVA Laura	0/2	0		0/1		0/1						
23	SPUGNINI SANTOME Alba Chiara	2/2	100	2/2									
29	GOMES DA COSTA Maria	0/1	0	0/1									
31	VEGUE I PENNA Ona	3/3	100	1/1	2/2								
32	CUADRADO SANCHEZ Elena	0/1	0	0/1						1			
33	GASSAMA CISSOKHO Kaba	1/4	25	1/4						1			
38	LOIDI ETXANIZ June												
41	WIGGINS SANCHO Nicole												
45	AALLA ROTAECHE Maddi												
47	VALERO JODAR Sara												
53	MBENGUE RODRIGUEZ Seynabou												
57	VALDIVIA MONSERRAT Paula Maria	1/1	100					1/1					
64	GASCO ARRANZ Clara	2/3	67		1/2			1/1					
67	ALVAREZ TORRADO Elba	5/6	83	4/5				1/1					
<b>Bench/Team</b>													
<b>Totals</b>		29/41	71	15/24	3/5	1/1	6/7	4/4		3			

Goalkeepers		Saves							
No.	Name	S / S	%	6m	Wing	9m	7m	FB	BT
41	WIGGINS SANCHO Nicole	7/19	37	4/6	0/2	2/3	0/6	1/2	
45	AALLA ROTAECHE Maddi	3/16	19	0/6	0/3	2/6		1/1	
<b>Totals</b>		10/35	29	4/12	0/5	4/9	0/6	2/3	

#### CRO - Croatia

Players		Shots								Punishment			
No.	Name	G / S	%	6m	Wing	9m	7m	FB	BT	YC	2Min	RC	BC
1	BESEN Lucija												
6	SENVALD Sara	1/3	33	1/3						1			
8	POSAVEC Stela (C)	4/6	67	2/4		1/1	1/1						
19	JAPUNDZA Tena	2/3	67		2/2	0/1							
23	PAVLOVIC Katarina	9/19	47	1/3		3/8	4/6	1/2					
28	SIMARA Andrea	0/1	0			0/1							
32	MALEC Ana	2/2	100	2/2									
38	BARISIC Tina												
40	PETIKA Tena	2/3	67	1/1		1/2				2			
47	TUCAKOVIC Antonija												
51	JARAK Lana	2/4	50	0/1	2/2			0/1					
53	VOJNOVIC Nika												
54	GUSKIC Ema	1/1	100	1/1						1			
58	BEBEK Josipa	2/2	100		1/1		1/1						
61	TUPEK Mia												
<b>Bench/Team</b>										1			
<b>Totals</b>		25/44	57	8/15	5/5	5/13	6/8	1/3		2	3		

Goalkeepers		Saves							
No.	Name	S / S	%	6m	Wing	9m	7m	FB	BT
1	BESEN Lucija								
47	TUCAKOVIC Antonija	7/36	19	5/20	1/4	0/1	1/7	0/4	
<b>Totals</b>		7/36	19	5/20	1/4	0/1	1/7	0/4	



WED 6 JUL 2022

## Results

Start Time 14:00

Game Duration: 01:23

### RUNNING SCORE

#### ESP - CRO

1st Half		2nd Half	
SPUGNINI A.	1 (2') 0	17 (33') 14	PAVLOVIC K.
ARROJERIA E.	2 (3') 0	18 (34') 14	ALVAREZ E.
CAMPOS C.	3 (4') 0	19 (35') 14	VEGUE O.
CAMPOS C.	4 (6') 0	19 (36') 15	PAVLOVIC K.
	4 (6') 1	19 (37') 16	POSAVEC S.
VALDIVIA P.	5 (6') 1	20 (38') 16	CAMPOS C.
	5 (7') 2	20 (38') 17	PAVLOVIC K.
CAMPOS C.	6 (8') 2	20 (40') 18	PAVLOVIC K.
	6 (8') 3	20 (43') 19	GUSKIC E.
	6 (10') 4	21 (44') 19	ARROJERIA E.
	6 (11') 5	22 (47') 19	ARROJERIA E.
CAMPOS C.	7 (13') 5	23 (48') 19	VEGUE O.
SPUGNINI A.	8 (14') 5	23 (51') 20	PAVLOVIC K.
	8 (14') 6	24 (52') 20	GASCO C.
ARROJERIA E.	9 (14') 6	24 (53') 21	BEBEK J.
CAMPOS C.	10 (16') 6	25 (53') 21	ALVAREZ E.
ARROJERIA E.	11 (17') 6	25 (54') 22	SENVALD S.
ARROJERIA E.	12 (18') 6	26 (55') 22	CAMPOS C.
	12 (18') 7	26 (57') 23	PAVLOVIC K.
	12 (19') 8	27 (58') 23	CAMPOS C.
CAMPOS C.	13 (22') 8	27 (59') 24	JAPUNDA T.
GASCO C.	14 (23') 8	28 (59') 24	ALVAREZ E.
	14 (23') 9	28 (60') 25	BEBEK J.
	14 (24') 10	29 (60') 25	VEGUE O.
	14 (25') 11		
ALVAREZ E.	15 (26') 11		
GASSAMA K.	16 (27') 11		
	16 (27') 12		
	16 (29') 13		
ALVAREZ E.	17 (30') 13		

#### LEGEND

%	Efficiency	(C)	Captain	2Min	2 minutes suspension	6m	6 metre Shots
7m	7 metre Shots	7mS	7 metre Saves	9m	9 metre Shots	BC	Blue Cards
BT	Break Through Shots	FB	Fast Break Shots	G / S	Goals/Shots	No.	Uniform Number
RC	Red Cards	S	Saves	Wing	Wing Shots	YC	Yellow Card



WED 6 JUL 2022

## Results

Start Time 9:00

Game Duration: 01:20

### POR 22 vs 26 SRB (12-10) (10-16)

Referees: Enrique PEREZ GONZALEZ (ESP) Luis DIAZ FLORES GOMEZ (ESP)

#### POR - Portugal

Players		Shots								Punishment			
No.	Name	G / S	%	6m	Wing	9m	7m	FB	BT	YC	2Min	RC	BC
1	FIGUEIRA I.												
6	NUNES MONTEIRO Carolina	2/5	40		2/4		0/1						
7	RODRIGUES B. (C)	3/8	38	2/5			1/3				1		
12	ROSA Matilde												
16	VARGAS FERREIRA Jessica Romina												
18	BRITO Mariana	2/4	50		2/4								
34	RESENDE REBELO Luciana	0/1	0			0/1							
36	FAGUNDES MORAIS Margarida												
38	PIRES Joana Rafaela												
42	BENTO DE CAMPOS Rita												
55	DUARTE Maria	4/5	80	3/3		1/2							
66	COSTA Mariana	1/2	50			1/2					1		
77	MINCIUNA Mihaela Oana	2/8	25	2/5		0/3							
81	CLAUDINO C.	4/9	44	2/4		1/4		1/1			1		
88	DUARTE Neide	4/6	67		0/1		4/5						
<b>Bench/Team</b>													
<b>Totals</b>		22/48	46	9/17	4/9	3/12	5/9	1/1			3		

Goalkeepers		Saves							
No.	Name	S / S	%	6m	Wing	9m	7m	FB	BT
1	FIGUEIRA I.	0/1	0				0/1		
12	ROSA Matilde	1/1	100				1/1		
16	VARGAS FERREIRA Jessica Romina	11/36	31	3/16	6/9	2/8	0/1	0/2	
<b>Totals</b>		12/38	32	3/16	6/9	2/8	1/3	0/2	

#### SRB - Serbia

Players		Shots								Punishment			
No.	Name	G / S	%	6m	Wing	9m	7m	FB	BT	YC	2Min	RC	BC
1	SIMIC Marija												
2	RADEVIC Dunja	5/5	100	1/1	3/3			1/1					
4	MJAJLOVIC Lana												
5	CETKOVIC Natasa	0/2	0		0/2								
6	OBRENOVIC Una												
7	VUKAJLOVIC Aleksandra	7/14	50	3/8		3/5		1/1			1		
8	INDIC Helena	0/1	0				0/1						
9	SUKUR Srna	0/1	0		0/1								
10	BOGUNOVIC Isidora	1/5	20	1/2	0/3								
12	DURASINOVIC Jelena												
13	JOVANOVIC Marija	2/3	67	2/2		0/1				1	2		
14	NUKOVIC Edita	1/2	50	1/2									
15	VELICKOVIC Teodora												
22	JOVOVIC Jovana (C)	7/10	70	2/2		3/5	2/3				2		
30	TABAK Dunja												
31	BOJICIC Katarina	3/3	100	3/3							1		
<b>Bench/Team</b>										1			
<b>Totals</b>		26/46	57	13/20	3/9	6/11	2/4	2/2		2	6		

Goalkeepers		Saves							
No.	Name	S / S	%	6m	Wing	9m	7m	FB	BT
1	SIMIC Marija	0/1	0				0/1		
12	DURASINOVIC Jelena	13/34	38	5/14	3/7	4/7	1/5	0/1	
<b>Totals</b>		13/35	37	5/14	3/7	4/7	1/6	0/1	



WED 6 JUL 2022

Start Time 9:00

Game Duration: 01:20

## Results

### RUNNING SCORE

1st Half		2nd Half	
	0 (2') 1 NUKOVIC E.		12 (31') 11 JOVOVIC J.
RODRIGUES B.	1 (2') 1		12 (32') 12 BOGUNOVIC I.
	1 (3') 2 VUKAJLOVIC A.	NUNES C.	13 (33') 12
CLAUDINO C.	2 (5') 2		13 (35') 13 JOVOVIC J.
	2 (6') 3 VUKAJLOVIC A.		13 (37') 14 RADEVIC D.
CLAUDINO C.	3 (6') 3		13 (38') 15 VUKAJLOVIC A.
	3 (8') 4 JOVOVIC J.	CLAUDINO C.	14 (38') 15
	3 (10') 5 BOJICIC K.		14 (41') 16 BOJICIC K.
	3 (15') 6 VUKAJLOVIC A.	NUNES C.	15 (41') 16
BRITO M.	4 (15') 6		15 (42') 17 VUKAJLOVIC A.
BRITO M.	5 (18') 6		15 (43') 18 VUKAJLOVIC A.
	5 (18') 7 JOVOVIC J.		15 (45') 19 RADEVIC D.
DUARTE M.	6 (19') 7		15 (46') 20 JOVOVIC J.
RODRIGUES B.	7 (20') 7		15 (47') 21 BOJICIC K.
MINCIUNA M.	8 (22') 7	MINCIUNA M.	16 (48') 21
RODRIGUES B.	9 (23') 7	DUARTE M.	17 (50') 21
DUARTE N.	10 (24') 7		17 (50') 22 RADEVIC D.
	10 (27') 8 JOVOVIC J.		17 (51') 23 VUKAJLOVIC A.
COSTA M.	11 (27') 8	DUARTE N.	18 (54') 23
	11 (28') 9 JOVOVIC J.		18 (54') 24 JOVANOVIC M.
DUARTE M.	12 (30') 9		18 (55') 25 JOVANOVIC M.
	12 (30') 10 RADEVIC D.	DUARTE M.	19 (56') 25
		DUARTE N.	20 (58') 25
			20 (59') 26 RADEVIC D.
		DUARTE N.	21 (59') 26
		CLAUDINO C.	22 (59') 26

#### LEGEND

%	Efficiency	(C)	Captain	2Min	2 minutes suspension	6m	6 metre Shots
7m	7 metre Shots	7mS	7metre Saves	9m	9 metre Shots	BC	Blue Cards
BT	Break Through Shots	FB	Fast Break Shots	G / S	Goals/Shots	No.	Uniform Number
RC	Red Cards	S	Saves	Wing	Wing Shots	YC	Yellow Card



MON 4 JUL 2022

**Results**

Start Time 12:30

Game Duration: 01:19

**TUN 29 vs 35 TUR**

(14-20) (15-15)

Referees: Lia Barbara DA SILVA PINHERIO (POR) Joana Filipa FERREIRA DA SILVA (POR)

**TUN - Tunisia**

No.	Name	G / S	%	Shots					Punishment					
				6m	Wing	9m	7m	FB	BT	YC	2Min	RC	BC	
1	GDOURA Omaima													
3	BEN AMMAR Rania	4/7	57	4/6				0/1				2		
5	BEN ABDALLAH Aya	0/1	0		0/1									
7	BOURI Fatma	3/5	60	0/2	1/1			2/2						
10	HAMROUNI Amal	3/5	60	1/1	0/1	1/2	1/1							
13	MOUEDEB Jawaher	2/3	67	1/1	0/1			1/1						
16	OMRANI Fadia													
17	JOUINI Chaima	2/7	29		0/1	2/4		0/2						
21	HACHANA EP KERKENI Sondes	6/9	67	2/3		2/3	2/2	0/1			1			
22	GHERISSI Elhem	2/3	67	1/1		0/1		1/1						
29	MASRI Aya	0/3	0	0/1		0/2								
32	ZELFANI Nada	2/4	50	0/1			2/2	0/1						
33	MKADEM Roa													
88	AOUIJ Fadwa	5/10	50	1/1	1/2	1/4	1/1	1/2			1			
94	REJEB Saïda													
98	BELHADJ Soumaya	0/1	0					0/1						
<b>Bench/Team</b>														
<b>Totals</b>		29/58	50	10/17	2/7	6/16	6/6	5/12			4			

Goalkeepers		Saves							
No.	Name	S / S	%	6m	Wing	9m	7m	FB	BT
1	GDOURA Omaima	8/23	35	2/7	0/3	4/6	1/2	1/5	
16	OMRANI Fadia	3/14	21	0/5	0/1	2/6		1/2	
33	MKADEM Roa	0/9	0	0/7		0/1		0/1	
<b>Totals</b>		11/46	24	2/19	0/4	6/13	1/2	2/8	

**TUR - Turkiye**

No.	Name	G / S	%	Shots					Punishment					
				6m	Wing	9m	7m	FB	BT	YC	2Min	RC	BC	
2	KARACAM Beyza	4/6	67	1/1		3/4	0/1							
7	OZBOLLUK Merve	1/5	20	1/3		0/2					1			
9	ISKIT Asli	6/9	67	2/2		4/7								
10	AYDIN Elif Sila	3/4	75	0/1	1/1			2/2						
14	GOKTEPE AKGUN Nurceren	2/2	100	2/2										
17	TURKOGLU Beyza Irem	4/6	67	2/2	1/1	0/1	1/1	0/1						
18	SOZMEN Ece	2/2	100	2/2										
21	YILMAZ Betul	1/1	100	1/1							2			
22	GOKER Yaren Berfe													
52	CALISKAN Neslihan	2/4	50	2/2		0/1		0/1						
55	KARA Aysenur	3/4	75	1/1	1/2			1/1						
58	DURDU Merve	1/1	100					1/1						
77	KUCUKYILDIZ Fatma	1/2	50	1/2							1			
87	GOKDEMIR Emine	2/2	100		1/1			1/1						
92	DEMIRCELEN Ceren	3/3	100	2/2				1/1			2			
<b>Bench/Team</b>														
<b>Totals</b>		35/51	69	17/21	4/5	7/15	1/2	6/8			1	5		

Goalkeepers		Saves							
No.	Name	S / S	%	6m	Wing	9m	7m	FB	BT
22	GOKER Yaren Berfe	1/3	33	0/2		1/1			
58	DURDU Merve	17/44	39	6/14	4/6	4/10	0/6	3/8	
<b>Totals</b>		18/47	38	6/16	4/6	5/11	0/6	3/8	



MON 4 JUL 2022

Start Time 12:30

Game Duration: 01:19

## Results

### RUNNING SCORE

1st Half		2nd Half	
	0 (') 1 ISKIT A.	14 (31') 21 DEMIRCELEN C.	
HAMROUNI A.	1 (4') 1	HAMROUNI A.	15 (32') 21
	1 (4') 2 ISKIT A.		15 (32') 22 KUCUKYILDIZ F.
HACHANA S.	2 (4') 2	GHERISSI E.	16 (33') 22
	2 (5') 3 SOZMEN E.		16 (34') 23 AYDIN E.
	2 (5') 4 SOZMEN E.	MOUEDEB J.	17 (35') 23
MOUEDEB J.	3 (5') 4	BOURI F.	18 (35') 23
	3 (5') 5 TURKOGLU B.	HACHANA S.	19 (36') 23
ZELFANI N.	4 (6') 5	AOUIJ F.	20 (38') 23
	4 (6') 6 DEMIRCELEN C.		20 (38') 24 YILMAZ B.
	4 (8') 7 OZBOLLUK M.	HACHANA S.	21 (40') 24
	4 (9') 8 GOKDEMIR E.		21 (41') 25 KARACAM B.
	4 (9') 9 GOKTEPE N.		21 (43') 26 KARA A.
HAMROUNI A.	5 (10') 9	BEN AMMAR R.	22 (44') 26
	5 (10') 10 GOKDEMIR E.	AOUIJ F.	23 (46') 26
JOUINI C.	6 (11') 10		23 (47') 27 TURKOGLU B.
AOUIJ F.	7 (14') 10		23 (48') 28 AYDIN E.
BOURI F.	8 (14') 10		23 (49') 29 DURDU M.
	8 (14') 11 TURKOGLU B.		23 (49') 30 KARA A.
BEN AMMAR R.	9 (15') 11	HACHANA S.	24 (50') 30
	9 (18') 12 ISKIT A.		24 (51') 31 TURKOGLU B.
BEN AMMAR R.	10 (19') 12	BEN AMMAR R.	25 (52') 31
	10 (20') 13 ISKIT A.		25 (52') 32 ISKIT A.
HACHANA S.	11 (20') 13	HACHANA S.	26 (54') 32
	11 (21') 14 KARA A.		26 (55') 33 CALISKAN N.
	11 (22') 15 GOKTEPE N.		26 (56') 34 ISKIT A.
	11 (23') 16 KARACAM B.	ZELFANI N.	27 (58') 34
BOURI F.	12 (23') 16		27 (59') 35 DEMIRCELEN C.
	12 (24') 17 CALISKAN N.	AOUIJ F.	28 (60') 35
	12 (24') 18 AYDIN E.	GHERISSI E.	29 (60') 35
JOUINI C.	13 (25') 18		
	13 (29') 19 KARACAM B.		
AOUIJ F.	14 (29') 19		
	14 (30') 20 KARACAM B.		

#### LEGEND

%	Efficiency	(C)	Captain	2Min	2 minutes suspension	6m	6 metre Shots
7m	7 metre Shots	7mS	7 metre Saves	9m	9 metre Shots	BC	Blue Cards
BT	Break Through Shots	FB	Fast Break Shots	G / S	Goals/Shots	No.	Uniform Number
RC	Red Cards	S	Saves	Wing	Wing Shots	YC	Yellow Card



MON 4 JUL 2022

## Results

Start Time 10:00

Game Duration: 00:49

**ALG 23 vs 31 MKD**  
 (12-17) (11-14)

Referees: Luis DIAZ FLORES GOMEZ (ESP) Enrique PEREZ GONZALEZ (ESP)

## ALG - Algeria

No.	Name	Players		Shots						Punishment				
		G / S	%	6m	Wing	9m	7m	FB	BT	YC	2Min	RC	BC	
1	GABOUR Naima													
2	AROUDJ Leila	0/4	0	0/2		0/2								
5	AMRANI Nassima	1/2	50	1/2										
7	HAIMER Fatiha	2/4	50	1/2				1/2			1			
8	ZAZAI Sabrina	7/13	54	0/1	5/8		2/2	0/2						
9	YELLES Loudmila Manel	0/1	0	0/1										
10	DJABOUR Waffya	2/2	100	2/2							2			
11	TAIBI Tasnime Shanez	2/2	100					2/2			1			
13	MAKHLOUFI Kenza	4/8	50		4/5	0/1		0/2						
19	BELOUCHARANI Feriel	1/2	50	1/1	0/1						1			
22	SALHI Tinhinane													
23	DERRADJ Imen													
26	ZOUAOUI Sylia													
27	AZZI Sarah	2/3	67	1/1				1/2						
31	BOUKAABENE Meriem	2/5	40	1/1		1/3		0/1						
Bench/Team														
Totals		23/46	50	7/13	9/14	1/6	2/2	4/11			5			

Goalkeepers		Saves							
No.	Name	S / S	%	6m	Wing	9m	7m	FB	BT
1	GABOUR Naima	12/37	32	4/14	2/4	5/12	0/6	1/1	
22	SALHI Tinhinane	3/9	33	3/7			0/1	0/1	
Totals		15/46	33	7/21	2/4	5/12	0/7	1/2	

## MKD - North Macedonia

No.	Name	Players		Shots						Punishment				
		G / S	%	6m	Wing	9m	7m	FB	BT	YC	2Min	RC	BC	
12	CHURLINOVSKA Matea													
13	KOLOVSKA Aleksandra													
14	DJATEVSKA Ivana	1/4	25	1/4										
15	JANKULOVSKA Marija	2/3	67			2/3								
16	JOVANOVSKA Marija													
17	DUKOSKA Teodora	10/13	77	1/1	0/2	3/4	6/6				1			
23	JANKULOVSKA Angela	0/1	0	0/1										
24	KOCEVA Bojana	1/1	100	1/1							1			
28	MINOVSKA Sara	4/7	57	2/4	2/2			0/1			1			
30	KIPRIJANOVSKA Jovana	4/6	67	1/1		2/4	1/1							
31	SEDLOSKA Andrea	2/2	100	2/2										
32	ARSENIEVSKA Ivana													
43	RIZOSKA Emilijana	3/8	38	2/4	0/1	0/1		1/2						
71	STEFANOVSKA Sara													
90	KOCEVA Boriana	4/8	50	4/7		0/1								
91	MLADENOVSKA Iva													
Bench/Team														
Totals		31/53	58	14/25	2/5	7/13	7/7	1/3			3			

Goalkeepers		Saves							
No.	Name	S / S	%	6m	Wing	9m	7m	FB	BT
12	CHURLINOVSKA Matea								
16	JOVANOVSKA Marija	11/34	32	5/12	3/12	1/2	0/2	2/6	
Totals		11/34	32	5/12	3/12	1/2	0/2	2/6	





MON 4 JUL 2022

Start Time 10:00

Game Duration: 00:49

## Results

### RUNNING SCORE

1st Half		2nd Half	
0 (1)	1 DUKOSKA T.	12 (32)	18 DJATEVSKA I.
0 (2)	2 SEDLOSKA A.	12 (33)	19 MINOVSKA S.
BOUKAABENE 1 (3)	2	12 (34)	20 DUKOSKA T.
1 (3)	3 KOCEVA B.	12 (36)	21 KOCEVA B.
MAKHLOUFI K. 2 (4)	3	12 (38)	22 DUKOSKA T.
DJABOUR W. 3 (5)	3	12 (39)	23 KIPRIJANOVSKA
3 (6)	4 SEDLOSKA A.	12 (39)	24 DUKOSKA T.
ZAZAI S. 4 (6)	4	ZAZAI S. 13 (40)	24
TAIBI T. 5 (7)	4	13 (40)	25 DUKOSKA T.
5 (8)	5 DUKOSKA T.	HAIMER F. 14 (41)	25
5 (9)	6 KIPRIJANOVSKA	14 (41)	26 KOCEVA B.
ZAZAI S. 6 (10)	6	MAKHLOUFI K. 15 (42)	26
6 (11)	7 JANKULOVSKA M.	HAIMER F. 16 (44)	26
MAKHLOUFI K. 7 (12)	7	BELOUCHRANI 17 (46)	26
7 (12)	8 KIPRIJANOVSKA	17 (48)	27 KOCEVA B.
7 (14)	9 DUKOSKA T.	ZAZAI S. 18 (50)	27
BOUKAABENE 8 (15)	9	ZAZAI S. 19 (51)	27
AZZI S. 9 (16)	9	ZAZAI S. 20 (51)	27
9 (17)	10 KOCEVA B.	20 (52)	28 KIPRIJANOVSKA
9 (18)	11 RIZOSKA E.	20 (54)	29 MINOVSKA S.
9 (20)	12 MINOVSKA S.	AMRANI N. 21 (56)	29
MAKHLOUFI K. 10 (21)	12	21 (57)	30 RIZOSKA E.
TAIBI T. 11 (22)	12	21 (58)	31 RIZOSKA E.
11 (23)	13 DUKOSKA T.	ZAZAI S. 22 (59)	31
11 (24)	14 JANKULOVSKA M.	DJABOUR W. 23 (60)	31
AZZI S. 12 (26)	14		
12 (26)	15 DUKOSKA T.		
12 (28)	16 DUKOSKA T.		
12 (29)	17 MINOVSKA S.		

#### LEGEND

%	Efficiency	(C)	Captain	2Min	2 minutes suspension	6m	6 metre Shots
7m	7 metre Shots	7mS	7 metre Saves	9m	9 metre Shots	BC	Blue Cards
BT	Break Through Shots	FB	Fast Break Shots	G / S	Goals/Shots	No.	Uniform Number
RC	Red Cards	S	Saves	Wing	Wing Shots	YC	Yellow Card



## Cumulative Statistics

As of WED 6 JUL 2022 at 15:45

ALG - Algeria

Including Game 44

Player		MP	Shots								Offense		Defence		Punishment				TP
No.	Name		G/S	%	6m	Wing	9m	7m	FB	BT	AS	TO	ST	BS	YC	2Min	RC	BC	
1	GABOUR Naima	4																25:25:37	
2	AROUDJ Leila	4	0/4		0/2			0/2										0:00	
5	AMRANI Nassima	4	1/2	50	1/2						1				1			30:30:00	
7	HAIMER Fatih	4	10/17	59	6/10			1/1				1				3		29:29:59	
8	ZAZAI Sabrina	4	17/30	57	1/3	7/12		9/13	0/2									59:59:59	
9	YELLES L.	4	9/23	39	6/10	0/2	3/11				2					1		29:29:59	
10	DJABOUR Waffya	4	4/7	57	3/4			1/3			1				1	5		30:30:00	
11	TAIBI T.	4	7/9	78	4/6			1/1		2/2		1			1	2		0:00:00	
13	MAKHLOUFI Kenza	4	18/31	58	3/6	7/9	1/4		7/12							3		0:00:00	
19	BELOUCHRANI	4	3/4	75	2/2	0/1	1/1				3					3		0:00:00	
22	SALHI Tinhinane	4																21:21:47	
23	DERRADJ Imen	4	4/11	36	1/5			2/5	1/1									0:00:00	
26	ZOUAOUI Sylia	4										1						0:00:00	
27	AZZI Sarah	4	7/12	58	4/5	1/1	1/4		1/2			1						0:00:00	
31	BOUKAABENE	4	3/10	30	1/2	0/1	2/6		0/1							1		0:00:00	
33	BENABDELHAFID	3																12:00	
Bench/Team																			
<b>Totals</b>			83/160	52	32/57	15/26	13/38	10/14	13/25			11			2	19			

Goalkeepers		Total Shots		6m Shots		Wing Shots		9m Shots		7m Shots		Fast Breaks		Breakthrough	
No.	Name	S/S	%	S/S	%	S/S	%	S/S	%	S/S	%	S/S	%	S/S	%
1	GABOUR Naima	19/66	29	8/31	8	2/6	33	6/13	46	6/11	46	1/5	20		
22	SALHI Tinhinane	19/74	26	8/33	8	0/5		8/15	53	8/12	53	1/9	11		
33	BENABDELHAFID Nadia	3/8	38	1/3	1							2/5	40		
<b>Totals</b>		41/148	28	17/67	17	2/11	18	14/28	50	14/23	50	4/19	21		

Team Shots	Goals	Saver	Missed	Post	Blocked	Total	%
6m Shots	32	20	5			57	56
Wing Shots	15	6	5			26	58
9m Shots	13	14	10	1		38	34
7m Shots	10	2	1	1	N/A	14	71
Fast Break Shots	13	4	8			25	52
Break Trough Shots							
<b>Totals</b>	83	46	29	2		160	52

Played		
PR	ESP	20 - 26
PR	CRO	21 - 31
PR	TUN	19 - 20
F7	MKD	23 - 31

### LEGEND

%	Efficiency	2Min	2 minute suspensions	6m	6 metre Shots	7m	7 metre Shots
9m	9 metre Shots	AS	Assists	BC	Blue Cards	BS	Blocked Shots
BT	Break Through Shots	FB	Fast Break Shots	G / S	Goals / Shots	GM	Gold Medal Match
MP	Match Played	N/A	Not Applicable	No.	Uniform Number	PR	Preliminary Round
YC	Yellow Card	TP	Time Played	WS	Wing Shot	YC	Yellow Card



## Cumulative Statistics

As of WED 6 JUL 2022 at 15:45

CRO - Croatia

Including Game 44

Player		MP	Shots								Offense		Defence		Punishment				TP
No.	Name		G/S	%	6m	Wing	9m	7m	FB	BT	AS	TO	ST	BS	YC	2Min	RC	BC	
1	BESEN Lucija	5	1/1	100				1/1											7:07:42
6	SENVALD Sara	5	7/11	64	5/8	0/1	1/1		1/1					2	3	1			1:01:06
8	POSAVEC Stela	5	16/21	76	14/19		1/1	1/1			1				1				50:50:59
19	JAPUNDZA Tena	5	15/20	75	6/8	8/10	0/1		1/1						1				55:55:10
23	PAVLOVIC K.	5	44/66	67	14/17		12/25	15/19	3/5	1	1			1	3				54:54:09
28	SIMARA Andrea	4	5/10	50	4/5	1/3	0/1		0/1						1				0:00:00
32	MALEC Ana	5	4/5	80	4/5														51:36
38	BARISIC Tina	5	12/20	60	5/9	1/2	5/8		1/1						2				20:20:25
40	PETIKA Tena	5	10/28	36	6/11		4/17			1	1		1	1	5				18:18:17
47	TUCAKOVIC A.	5																	52:52:08
51	JARAK Lana	5	16/20	80	2/4	6/6		8/10							1				0:00:00
53	VOJNOVIC Nika	5	1/2	50	1/1			0/1											51:52
54	GUSKIC Ema	5	3/3	100	2/2			1/1							2				22:54
58	BEBEK Josipa	5	3/4	75		1/2		2/2											0:00:00
61	TUPEK Mia	5	1/1	100	1/1						1				1				30:00
Bench/Team														4					
<b>Totals</b>			138/212	65	64/90	17/24	23/54	18/22	16/22		2	4		1	8	20	1		

Goalkeepers		Total Shots		6m Shots		Wing Shots		9m Shots		7m Shots		Fast Breaks		Breakthrough	
No.	Name	S/S	%	S/S	%	S/S	%	S/S	%	S/S	%	S/S	%	S/S	%
1	BESEN Lucija	11/36	31	6/14	6	0/1		3/12	25	3/6	25	0/3			
47	TUCAKOVIC Antonija	35/137	26	14/57	14	5/17	29	10/24	42	10/24	42	1/15	7		
<b>Totals</b>		46/173	27	20/71	20	5/18	28	13/36	36	13/30	36	1/18	6		

Team Shots	Goals	Saver	Missed	Post	Blocked	Total	%
6m Shots	64	13	12		1	90	71
Wing Shots	17	5	1		1	24	71
9m Shots	23	18	8	2	3	54	43
7m Shots	18	2	1	1	N/A	22	82
Fast Break Shots	16	6				22	73
Break Trough Shots							
<b>Totals</b>	138	44	22	3	5	212	65

Played		
PR	TUN	28 - 26
PR	ALG	31 - 21
PR	ESP	23 - 31
SFL	SRB	31 - 20
F1	ESP	25 - 29

### LEGEND

%	Efficiency	2Min	2 minute suspensions	6m	6 metre Shots	7m	7 metre Shots
9m	9 metre Shots	AS	Assists	BC	Blue Cards	BS	Blocked Shots
BT	Break Through Shots	FB	Fast Break Shots	G / S	Goals / Shots	GM	Gold Medal Match
MP	Match Played	N/A	Not Applicable	No.	Uniform Number	PR	Preliminary Round
YC	Yellow Card	TP	Time Played	WS	Wing Shot	YC	Yellow Card



## Cumulative Statistics

As of WED 6 JUL 2022 at 15:45

ESP - Spain

### Including Game 44

Player		MP	Shots								Offense		Defence		Punishment				TP
No.	Name		G/S	%	6m	Wing	9m	7m	FB	BT	AS	TO	ST	BS	YC	2Min	RC	BC	
6	CAMPOS C.	5	34/43	79	15/17			3/7	15/18	1/1									10:10:53
7	ARROJERIA E.	5	20/32	63	15/26			2/3		3/3					4				37:37:16
13	HERNANDEZ L.	5	7/16	44	1/4	1/3		0/1	3/6	2/2									50:50:56
23	SPUGNINI A.	5	8/8	100	7/7					1/1									4:04:45
29	GOMES M.	5	6/14	43	2/4			3/9		1/1					2				15:15:58
31	VEGUE O.	5	13/17	76	3/5	6/7			4/5										37:37:38
32	CUADRADO E.	5	10/16	63	7/10	0/1		2/4		1/1								5	15:15:54
33	GASSAMA K.	5	4/9	44	4/8	0/1												2	12:12:23
38	LOIDI J.	5	3/3	100	1/1					2/2								1	30:30:00
41	WIGGINS N.	5																	23:23:14
45	AALLA M.	5																	36:36:48
47	VALERO S.	5	4/6	67	3/5					1/1								1	20:20:42
53	MBENGUE S.	5	1/2	50	1/2														30:00
57	VALDIVIA P.	5	11/16	69	5/7	2/3		0/1		4/5									6:06:12
64	GASCO C.	5	8/14	57	2/2	5/10				1/2								1	32:32:14
67	ALVAREZ E.	5	11/17	65	10/15	0/1				1/1								2	55:55:38
Bench/Team															2				
<b>Totals</b>			140/213	66	76/11	14/26	10/25	22/29	18/20		3	5	1	2	6	16			

Goalkeepers		Total Shots		6m Shots		Wing Shots		9m Shots		7m Shots		Fast Breaks		Breakthrough	
No.	Name	S/S	%	S/S	%	S/S	%	S/S	%	S/S	%	S/S	%	S/S	%
41	WIGGINS SANCHO Nicole	28/83	34	14/35	14	2/12	17	11/20	55	11/11	55	1/5	20		
45	AALLA ROTAECHE Maddi	22/80	28	4/35	4	1/10	10	14/26	54	14/4	54	3/5	60		
<b>Totals</b>		50/163	31	18/70	18	3/22	14	25/46	54	25/15	54	4/10	40		

Team Shots	Goals	Saver	Missed	Post	Blocked	Total	%
6m Shots	76	20	12	4	1	113	67
Wing Shots	14	6	3	3		26	54
9m Shots	10	7	7	1		25	40
7m Shots	22	5		2	N/A	29	76
Fast Break Shots	18	1		1		20	90
Break Trough Shots							
<b>Totals</b>	140	39	22	11	1	213	66

Played		
PR	ALG	26 - 20
PR	TUN	28 - 21
PR	CRO	31 - 23
SFL	POR	26 - 24
F1	CRO	29 - 25

#### LEGEND

%	Efficiency	2Min	2 minute suspensions	6m	6 metre Shots	7m	7 metre Shots
9m	9 metre Shots	AS	Assists	BC	Blue Cards	BS	Blocked Shots
BT	Break Through Shots	FB	Fast Break Shots	G / S	Goals / Shots	GM	Gold Medal Match
MP	Match Played	N/A	Not Applicable	No.	Uniform Number	PR	Preliminary Round
YC	Yellow Card	TP	Time Played	WS	Wing Shot	YC	Yellow Card



## Cumulative Statistics

As of WED 6 JUL 2022 at 15:45

MKD - North Macedonia

Including Game 44

Player		MP	Shots								Offense		Defence		Punishment				TP
No.	Name		G/S	%	6m	Wing	9m	7m	FB	BT	AS	TO	ST	BS	YC	2Min	RC	BC	
12	CHURLINOVSKA M.	4																	4:04:05
13	KOLOVSKA A.	4	0/2		0/1			0/1							3				30:00
14	DJATEVSKA Ivana	4	7/11	64	5/9			1/1	1/1		1								59:59:59
15	JANKULOVSKA M.	4	2/3	67				2/3											25:25:50
16	JOVANOVSKA M.	4																	29:29:59
17	DUKOSKA Teodora	4	29/51	57	6/8	2/7	5/19	15/16	1/1		1				2				29:29:59
23	JANKULOVSKA A.	4	2/6	33	1/2		0/3	1/1											0:00:00
24	KOCEVA Bojana	4	1/1	100	1/1										3				33:33:08
28	MINOVSKA Sara	4	10/18	56	2/5	6/9		0/1	2/3						1				59:59:59
30	KIPRIJANOVSKA	4	15/20	75	5/6			4/7	6/7						3				59:59:59
31	SEDLOSKA Andrea	4	6/12	50	5/6	0/1	1/4	0/1			2				1				0:00:00
32	ARSENIEVSKA I.	4	5/12	42	1/3	0/1	4/8				1				1				29:29:59
43	RIZOSKA E.	4	4/11	36	3/6	0/2	0/1		1/2						1				0:00:00
71	STEFANOVSKA S.	4										1							0:00
90	KOCEVA Borjana	4	8/22	36	7/17	0/2	0/2		1/1		2				1				56:50
91	MLADENOVSKA Iva	4	4/15	27	0/3	0/1	4/11												0:00
Bench/Team															2				
<b>Totals</b>			93/184	51	36/67	8/23	20/59	23/27	6/8			8			2	16			

Goalkeepers		Total Shots		6m Shots		Wing Shots		9m Shots		7m Shots		Fast Breaks		Breakthrough	
No.	Name	S/S	%	S/S	%	S/S	%	S/S	%	S/S	%	S/S	%	S/S	%
12	CHURLINOVSKA Matea	4/26	15	0/13		2/2	100	2/4	50	2/6	50	0/1			
16	JOVANOVSKA Marija	28/108	26	11/37	11	8/25	32	5/20	25	5/10	25	2/16	13		
<b>Totals</b>		32/134	24	11/50	11	10/27	37	7/24	29	7/16	29	2/17	12		

Team Shots	Goals	Saver	Missed	Post	Blocked	Total	%
6m Shots	36	20	9	2		67	54
Wing Shots	8	10	5			23	35
9m Shots	20	24	12	3		59	34
7m Shots	23	4			N/A	27	85
Fast Break Shots	6	1	1			8	75
Break Trough Shots							
<b>Totals</b>	93	59	27	5		184	51

Played		
PR	TUR	27 - 34
PR	SRB	18 - 26
PR	POR	17 - 19
F7	ALG	31 - 23

### LEGEND

%	Efficiency	2Min	2 minute suspensions	6m	6 metre Shots	7m	7 metre Shots
9m	9 metre Shots	AS	Assists	BC	Blue Cards	BS	Blocked Shots
BT	Break Through Shots	FB	Fast Break Shots	G / S	Goals / Shots	GM	Gold Medal Match
MP	Match Played	N/A	Not Applicable	No.	Uniform Number	PR	Preliminary Round
YC	Yellow Card	TP	Time Played	WS	Wing Shot	YC	Yellow Card



## Cumulative Statistics

As of WED 6 JUL 2022 at 15:45

POR - Portugal

Including Game 44

Player		MP	Shots								Offense		Defence		Punishment				TP
No.	Name		G/S	%	6m	Wing	9m	7m	FB	BT	AS	TO	ST	BS	YC	2Min	RC	BC	
1	FIGUEIRA I.	4																	36:36:19
6	NUNES C.	5	7/16	44	2/4	2/7		0/1	3/3	0/1									39:39:01
7	RODRIGUES B.	5	29/43	67	12/21	1/2		13/16	3/4							3			42:42:27
12	ROSA Matilde	5																	21:16
16	VARGAS J.	5																	2:02:23
18	BRITO Mariana	5	4/8	50		4/8							1			2			52:52:33
34	RESENDE L.	5	12/26	46	7/12	1/1	4/13					1				1			30:30:36
36	FAGUNDES M.	5	1/1	100	1/1											3			48:48:18
38	PIRES J.	5	2/3	67	2/2	0/1													20:20:42
42	BENTO R.	5	1/1	100	1/1														41:41:15
55	DUARTE Maria	5	11/22	50	8/12		2/9		1/1										40:40:55
66	COSTA Mariana	5	8/14	57	6/6	0/1	2/7					1				1			16:16:15
77	MINCIUNA M.	5	18/37	49	12/20	1/2	5/14		0/1							2			41:41:48
81	CLAUDINO C.	5	16/32	50	7/12		8/19		1/1							1	4		43:43:06
88	DUARTE Neide	5	6/13	46		2/7		4/5	0/1				1						2:02:41
99	GOMES M.																		
	Bench/Team															1			
<b>Totals</b>			115/216	53	58/91	11/29	21/62	17/22	8/11	0/1			5	2		2	16		

Goalkeepers		Total Shots		6m Shots		Wing Shots		9m Shots		7m Shots		Fast Breaks		Breakthrough	
No.	Name	S/S	%	S/S	%	S/S	%	S/S	%	S/S	%	S/S	%	S/S	%
1	FIGUEIRA DE GOIS Isabel Cristi	23/58	40	14/28	14	3/8	38	4/8	50	4/12	50	0/2			
12	ROSA Matilde	3/12	25	0/5		1/3	33	1/1	100	1/3	100				
16	VARGAS FERREIRA Jessica Ro	37/109	34	12/50	12	12/18	67	11/23	48	11/11	48	0/7			
<b>Totals</b>		63/179	35	26/83	26	16/29	55	16/32	50	16/26	50	0/9			

Team Shots	Goals	Saver	Missed	Post	Blocked	Total	%
6m Shots	58	20	12	1		91	64
Wing Shots	11	11	6	1		29	38
9m Shots	21	22	12	4	3	62	34
7m Shots	17	2	1	2	N/A	22	77
Fast Break Shots	8	2	1			11	73
Break Trough Shots		1				1	
<b>Totals</b>	115	58	32	8	3	216	53

Played		
PR	SRB	20 - 21
PR	TUR	30 - 26
PR	MKD	19 - 17
SFL	ESP	24 - 26
F3	SRB	22 - 26

### LEGEND

%	Efficiency	2Min	2 minute suspensions	6m	6 metre Shots	7m	7 metre Shots
9m	9 metre Shots	AS	Assists	BC	Blue Cards	BS	Blocked Shots
BT	Break Through Shots	FB	Fast Break Shots	G / S	Goals / Shots	GM	Gold Medal Match
MP	Match Played	N/A	Not Applicable	No.	Uniform Number	PR	Preliminary Round
YC	Yellow Card	TP	Time Played	WS	Wing Shot	YC	Yellow Card



## Cumulative Statistics

As of WED 6 JUL 2022 at 15:45

SRB - Serbia

Including Game 44

Player		MP	Shots								Offense		Defence		Punishment				TP
No.	Name		G/S	%	6m	Wing	9m	7m	FB	BT	AS	TO	ST	BS	YC	2Min	RC	BC	
1	SIMIC Marija	5																	17:17:22
2	RADEVIC Dunja	5	8/12	67	1/1	5/9			2/2										46:46:43
4	MIJAILOVIC Lana	5	0/1					0/1											5:35
5	CETKOVIC Natasa	5	3/9	33	1/1	2/8					1				1				56:50
6	OBRENOVIC Una	5	1/3	33	1/3						1				2				42:42:26
7	VUKAJLOVIC A.	5	24/48	50	11/25	0/1	10/19	1/1	2/2		1		1		3	1			43:43:49
8	INDIC Helena	5	0/2		0/1			0/1											3:03:02
9	SUKUR Sma	5	6/11	55	2/2	4/9								1					33:33:36
10	BOGUNOVIC I.	5	10/19	53	3/6	6/11	0/1		1/1										4:04:38
12	DURASINOVIC J.	5																	42:42:34
13	JOVANOVIC M.	5	9/13	69	8/10	1/1	0/2				1		2	2	5				12:12:44
14	NUKOVIC Edita	5	10/17	59	10/17						1		1		1				53:53:06
15	VELICKOVIC T.	5	5/8	63				5/8											30:31
22	JOVOVIC Jovana	5	34/53	64	9/14	1/1	15/25	8/12	1/1				1		6				21:21:35
30	TABAK Dunja	5	6/10	60	1/2		4/6	1/2											13:44
31	BOJICIC K.	5	8/14	57	8/12	0/1	0/1								2				51:51:57
Bench/Team														6					
<b>Totals</b>			124/220	56	55/94	19/41	29/54	15/25	6/6			5		5	9	20	1		

Goalkeepers		Total Shots		6m Shots		Wing Shots		9m Shots		7m Shots		Fast Breaks		Breakthrough	
No.	Name	S/S	%	S/S	%	S/S	%	S/S	%	S/S	%	S/S	%	S/S	%
1	SIMIC Marija	26/83	31	8/31	8	3/10	30	11/26	42	11/7	42	1/9	11		
12	DURASINOVIC Jelena	43/103	42	15/38	15	7/16	44	17/30	57	17/11	57	1/8	13		
<b>Totals</b>		69/186	37	23/69	23	10/26	38	28/56	50	28/18	50	2/17	12		

Team Shots	Goals	Saver	Missed	Post	Blocked	Total	%
6m Shots	55	25	13	1		94	59
Wing Shots	19	18	4			41	46
9m Shots	29	15	7	3		54	54
7m Shots	15	6	4		N/A	25	60
Fast Break Shots	6					6	100
Break Trough Shots							
<b>Totals</b>	124	64	28	4		220	56

Played		
PR	POR	21 - 20
PR	MKD	26 - 18
PR	TUR	31 - 26
SFL	CRO	20 - 31
F3	POR	26 - 22

### LEGEND

%	Efficiency	2Min	2 minute suspensions	6m	6 metre Shots	7m	7 metre Shots
9m	9 metre Shots	AS	Assists	BC	Blue Cards	BS	Blocked Shots
BT	Break Through Shots	FB	Fast Break Shots	G / S	Goals / Shots	GM	Gold Medal Match
MP	Match Played	N/A	Not Applicable	No.	Uniform Number	PR	Preliminary Round
YC	Yellow Card	TP	Time Played	WS	Wing Shot	YC	Yellow Card



## Cumulative Statistics

As of WED 6 JUL 2022 at 15:45

TUN - Tunisia

Including Game 44

Player		MP	Shots								Offense		Defence		Punishment				TP
No.	Name		G/S	%	6m	Wing	9m	7m	FB	BT	AS	TO	ST	BS	YC	2Min	RC	BC	
1	GDOURA Omaima	4																	38:59
3	BEN AMMAR Rania	4	6/11	55	6/10				0/1						6				30:30:00
5	BEN ABDALLAH A.	4	4/5	80	2/2	1/2			1/1					1					0:00:00
7	BOURI Fatma	4	10/17	59	2/5	4/5			4/7						3				59:59:59
10	HAMROUNI Amal	4	17/27	63	5/11	1/2	3/4	7/9	1/1				1						59:59:59
13	MOUEDEB Jawaher	4	5/6	83	3/3	1/2			1/1										30:30:00
16	OMRANI Fadia	4																	43:51
17	JOUINI Chaima	4	7/14	50	2/3	0/1	5/8		0/2						2				0:00:00
21	HACHANA S.	4	16/25	64	7/12		3/6	6/6	0/1						4				29:29:59
22	GHERISSI Elhem	4	2/3	67	1/1		0/1		1/1		1								0:00:00
29	MASRI Aya	4	9/23	39	4/8		3/13		2/2										0:00:00
32	ZELFANI Nada	4	4/8	50	1/4	1/1		2/2	0/1						1				0:00:00
33	MKADEM Roa	4	1/1	100	1/1														36:36:57
88	AOUIJ Fadwa	4	12/25	48	3/9	1/2	1/4	4/5	3/5						1				30:00
94	REJEB Saida	4	1/1	100					1/1										30:00
98	BELHADJ Soumaya	4	2/6	33	2/3		0/2		0/1						1				30:30:00
Bench/Team														1					
<b>Totals</b>			96/172	56	39/72	9/15	15/38	19/22	14/25			1		1	2	18			

Team Shots	Goals	Saver	Missed	Post	Blocked	Total	%
6m Shots	39	22	10	1		72	54
Wing Shots	9	4	2			15	60
9m Shots	15	12	9	2		38	39
7m Shots	19	2	1		N/A	22	86
Fast Break Shots	14	5	5	1		25	56
Break Trough Shots							
<b>Totals</b>	96	45	27	4		172	56

Played		
PR	CRO	26 - 28
PR	ESP	21 - 28
PR	ALG	20 - 19
F5	TUR	29 - 35

### LEGEND

%	Efficiency	2Min	2 minute suspensions	6m	6 metre Shots	7m	7 metre Shots
9m	9 metre Shots	AS	Assists	BC	Blue Cards	BS	Blocked Shots
BT	Break Through Shots	FB	Fast Break Shots	G / S	Goals / Shots	GM	Gold Medal Match
MP	Match Played	N/A	Not Applicable	No.	Uniform Number	PR	Preliminary Round
YC	Yellow Card	TP	Time Played	WS	Wing Shot	YC	Yellow Card





## Cumulative Statistics

As of WED 6 JUL 2022 at 15:45

TUR - Turkiye

### Including Game 44

Player		MP	Shots								Offense		Defence		Punishment				TP
No.	Name		G/S	%	6m	Wing	9m	7m	FB	BT	AS	TO	ST	BS	YC	2Min	RC	BC	
2	KARACAM Beyza	4	12/18	67	2/2	1/1	9/13	0/1	0/1		2								30:00
7	OZBOLLUK Merve	3	5/10	50	3/5		2/5							1					30:00
9	ISKIT Asli	4	18/28	64	6/8		10/17	1/2	1/1						1				0:00:00
10	AYDIN Elif Sila	4	16/21	76	3/5	6/8			7/8						2				0:00:00
14	GOKTEPE N.	4	8/8	100	8/8										1				59:59:59
17	TURKOGLU B.	4	19/25	76	6/6	6/10	0/1	2/2	5/6		3				2				29:29:59
18	SOZMEN Ece	4	3/3	100	3/3														30:30:00
21	YILMAZ Betul	4	3/5	60	2/2		0/1		1/2					1	4				4:04:26
22	GOKER Y.	4																	18:50
23	SAHIN Yasemin	3	10/14	71	3/4		3/5	3/4	1/1		1								55:55:28
52	CALISKAN N.	4	7/13	54	5/5		2/7		0/1						6				29:29:59
55	KARA Aysenur	4	4/7	57	1/1	1/3			2/3										0:00:00
58	DURDU Merve	4	3/3	100	1/1				2/2										41:41:05
77	KUCUKYILDIZ F.	4	6/10	60	3/6			2/3	1/1		1				4				0:00:00
87	GOKDEMIR Emine	4	3/6	50	0/1	2/4			1/1					1	1				0:00:00
92	DEMIRCELEN C.	4	4/4	100	3/3				1/1		1				2				30:00
Bench/Team														4					
<b>Totals</b>			121/175	69	49/60	16/26	26/49	8/12	22/28		8				7	23			

Goalkeepers		Total Shots		6m Shots		Wing Shots		9m Shots		7m Shots		Fast Breaks		Breakthrough	
No.	Name	S/S	%	S/S	%	S/S	%	S/S	%	S/S	%	S/S	%	S/S	%
22	GOKER Yaren Berfe	3/11	27	0/5		2/4	50	1/2	50						
58	DURDU Merve	48/157	31	17/63	17	12/24	50	13/35	37	13/19	37	4/15	27	1/1	100
<b>Totals</b>		51/168	30	17/68	17	14/28	50	14/37	38	14/19	38	4/15	27	1/1	100

Team Shots	Goals	Saver	Missed	Post	Blocked	Total	%
6m Shots	49	7	4			60	82
Wing Shots	16	6	4			26	62
9m Shots	26	18	4	1		49	53
7m Shots	8	3	1		N/A	12	67
Fast Break Shots	22	3	3			28	79
Break Trough Shots							
<b>Totals</b>	121	37	16	1		175	69

Played		
PR	MKD	34 - 27
PR	POR	26 - 30
PR	SRB	26 - 31
F5	TUN	35 - 29

#### LEGEND

%	Efficiency	2Min	2 minute suspensions	6m	6 metre Shots	7m	7 metre Shots
9m	9 metre Shots	AS	Assists	BC	Blue Cards	BS	Blocked Shots
BT	Break Through Shots	FB	Fast Break Shots	G / S	Goals / Shots	GM	Gold Medal Match
MP	Match Played	N/A	Not Applicable	No.	Uniform Number	PR	Preliminary Round
YC	Yellow Card	TP	Time Played	WS	Wing Shot	YC	Yellow Card



## Overall Team Statistics

As of WED 6 JUL 2022 at 15:46

### Players

Team	MP	Total Shots		6m Shots		Wing Shots		9m Shots		7m Shots		Fast Breaks		Breakthroughs		Offence		Defence		Punishments			
		G/S	%	G/S	%	G/S	%	G/S	%	G/S	%	G/S	%	G/S	%	AS	TO	ST	BS	YC	2M	RC	BC
ALG	4	83/160	52	32/57	56	15/26	58	13/38	34	10/14	71	13/25	52	0/0			11			2	19		
CRO	5	138/212	65	64/90	71	17/24	71	23/54	43	18/22	82	16/22	73	0/0		2	4		1	8	20	1	
ESP	5	140/213	66	76/113	67	14/26	54	10/25	40	22/29	76	18/20	90	0/0		3	5	1	2	6	16		
MKD	4	93/184	51	36/67	54	8/23	35	20/59	34	23/27	85	6/8	75	0/0			8			2	16		
POR	5	115/216	53	58/91	64	11/29	38	21/62	34	17/22	77	8/11	73	0/1			5	2		2	16		
SRB	5	124/220	56	55/94	59	19/41	46	29/54	54	15/25	60	6/6	100	0/0			5		5	9	20	1	
TUN	4	96/172	56	39/72	54	9/15	60	15/38	39	19/22	86	14/25	56	0/0			1		1	2	18		
TUR	4	121/175	69	49/60	82	16/26	62	26/49	53	8/12	67	22/28	79	0/0			8			7	23		
<b>Total</b>		910/1552	59	409/644	64	109/210	52	157/379	41	132/173	76	103/145	71	0/1		5	47	3	9	38	148	2	

### Goalkeepers

Team	MP	Total Shots		6m Shots		Wing Shots		9m Shots		7m Shots		Fast Breaks		Breakthroughs	
		S/S	%	S/S	%	S/S	%	S/S	%	S/S	%	S/S	%	S/S	%
ALG	4	41/148	28	17/67	25	2/11	18	14/28	50	4/23	17	4/19	21	0/0	
CRO	5	46/173	27	20/71	28	5/18	28	13/36	36	7/30	23	1/18	6	0/0	
ESP	5	50/163	31	18/70	26	3/22	14	25/46	54	0/15		4/10	40	0/0	
MKD	4	32/134	24	11/50	22	10/27	37	7/24	29	2/16	13	2/17	12	0/0	
POR	5	63/179	35	26/83	31	16/29	55	16/32	50	5/26	19	0/9		0/0	
SRB	5	69/186	37	23/69	33	10/26	38	28/56	50	6/18	33	2/17	12	0/0	
TUR	4	51/168	30	17/68	25	14/28	50	14/37	38	1/19	5	4/15	27	1/1	100
<b>Total</b>		352/115	31	132/478	28	60/161	37	117/259	45	25/147	17	17/105	16	1/1	100

### LEGEND

%	Efficiency	2Min	2 minute suspensions	AS	Assists	BC	Blue Cards
BS	Blocked Shots	G / S	Goals/Shots	MP	Match Played	RC	Red Card
S / S	Saved / shots	ST	Steals	TO	Turnovers		



## Individual Statistics

As of WED 6 JUL 2022 at 18:10

### GOALSCORERS

Rank	Name	Team	Goal	Shots	%	7 M Shots	MP
1	Katarina PAVLOVIC	CRO	44	66	67	15/19	5
2	Carmen CAMPOS COSTA	ESP	34	43	79	15/18	5
2	Jovana JOVOVIC	SRB	34	53	64	8/12	5
4	Teodora DUKOSKA	MKD	29	51	57	15/16	4
4	Bebiana Catarina RODRIGUES SABINO	POR	29	43	67	13/16	5
6	Aleksandra VUKAJLOVIC	SRB	24	48	50	1/1	5
7	Esther ARROJERIA	ESP	20	32	63		5
8	Beyza Irem TURKOGLU	TUR	19	25	76	2/2	4
9	Asli ISKIT	TUR	18	28	64	1/2	4
9	Kenza MAKHLOUFI	ALG	18	31	58		4
9	Mihaela Oana MINCIUNA	POR	18	37	49		5
12	Amal HAMROUNI	TUN	17	27	63	7/9	4
12	Sabrina ZAZAI	ALG	17	30	57	9/13	4
14	Elif Sila AYDIN	TUR	16	21	76		4
14	Carmen Filipa CLAUDINO FIGUEIREDO	POR	16	32	50		5
14	Sondes HACHANA EP KERKENI	TUN	16	25	64	6/6	4
14	Lana JARAK	CRO	16	20	80		5
14	Stela POSAVEC	CRO	16	21	76	1/1	5
19	Tena JAPUNDZA	CRO	15	20	75		5
19	Jovana KIPRIJANOVSKA	MKD	15	20	75	6/7	4
21	Ona VEGUE I PENA	ESP	13	17	76	4/5	5
22	Fadwa AOUIJ	TUN	12	25	48	4/5	4
22	Tina BARISIC	CRO	12	20	60		5
22	Beyza KARACAM	TUR	12	18	67	0/1	4
22	Luciana RESENDE REBELO	POR	12	26	46		5
26	Elba ALVAREZ TORRADO	ESP	11	17	65		5
26	Maria DUARTE	POR	11	22	50		5
26	Paula Maria VALDIVIA MONSERRAT	ESP	11	16	69		5
29	Isidora BOGUNOVIC	SRB	10	19	53		5
29	Fatma BOURI	TUN	10	17	59		4
29	Elena CUADRADO SANCHEZ	ESP	10	16	63		5
29	Fatiha HAIMER	ALG	10	17	59		4
29	Sara MINOVSKA	MKD	10	18	56	0/1	4
29	Edita NUKOVIC	SRB	10	17	59		5
29	Tena PETIKA	CRO	10	28	36		5
29	Yasemin SAHIN	TUR	10	14	71	3/4	3
37	Marija JOVANOVIC	SRB	9	13	69		5
37	Aya MASRI	TUN	9	23	39		4
37	Loudmila Manel YELLES	ALG	9	23	39		4
40	Katarina BOJICIC	SRB	8	14	57		5
40	Mariana COSTA	POR	8	14	57		5
40	Clara GASCO ARRANZ	ESP	8	14	57		5
40	Nurceren GOKTEPE AKGUN	TUR	8	8	100		4



## Individual Statistics

As of WED 6 JUL 2022 at 18:10

Rank	Name	Team	Goals	Shots	%	7m Shots	MP
40	Borjana KOCEVA	MKD	8	22	36		4
40	Dunja RADEVIC	SRB	8	12	67		5
40	Alba Chiara SPUGNINI SANTOME	ESP	8	8	100		5
47	Sarah AZZI	ALG	7	12	58		4
47	Neslihan CALISKAN	TUR	7	13	54		4
47	Ivana DJATEVSKA	MKD	7	11	64	1/1	4
47	Laura HERNANDEZ SELVA	ESP	7	16	44	3/6	5
47	Chaima JOUINI	TUN	7	14	50		4
47	Carolina NUNES MONTEIRO	POR	7	16	44	0/1	5
47	Sara SENVALD	CRO	7	11	64		5
47	Tasnime Shanz TAIBI	ALG	7	9	78		4
55	Rania BEN AMMAR	TUN	6	11	55		4
55	Neide DUARTE	POR	6	13	46	4/5	5
55	Maria GOMES DA COSTA	ESP	6	14	43		5
55	Fatma KUCUKYILDIZ	TUR	6	10	60	2/3	4
55	Andrea SEDLOSKA	MKD	6	12	50	0/1	4
55	Srna SUKUR	SRB	6	11	55		5
55	Dunja TABAK	SRB	6	10	60	1/2	5
62	Ivana ARSENIEVSKA	MKD	5	12	42		4
62	Jawaher MOUEDEB	TUN	5	6	83		4
62	Merve OZBOLLUK	TUR	5	10	50		3
62	Andrea SIMARA	CRO	5	10	50		4
62	Teodora VELICKOVIC	SRB	5	8	63	5/8	5
67	Aya BEN ABDALLAH	TUN	4	5	80		4
67	Mariana BRITO	POR	4	8	50		5
67	Ceren DEMIRCELEN	TUR	4	4	100		4
67	Imen DERRADJ	ALG	4	11	36	1/1	4
67	Waffya DJABOUR	ALG	4	7	57		4
67	Kaba GASSAMA CISSOKHO	ESP	4	9	44		5
67	Aysenur KARA	TUR	4	7	57		4
67	Ana MALEC	CRO	4	5	80		5
67	Iva MLADENOVSKA	MKD	4	15	27		4
67	Emilijana RIZOSKA	MKD	4	11	36		4
67	Sara VALERO JODAR	ESP	4	6	67		5
67	Nada ZELFANI	TUN	4	8	50	2/2	4
79	Josipa BEBEK	CRO	3	4	75	2/2	5
79	Feriel BELOUCHRANI	ALG	3	4	75		4
79	Meriem BOUKAABENE	ALG	3	10	30		4
79	Natasa CETKOVIC	SRB	3	9	33		5
79	Merve DURDU	TUR	3	3	100		4
79	Emine GOKDEMIR	TUR	3	6	50		4
79	Ema GUSKIC	CRO	3	3	100		5
79	June LOIDI ETXANIZ	ESP	3	3	100		5
79	Ece SOZMEN	TUR	3	3	100		4
79	Betul YILMAZ	TUR	3	5	60		4



## Individual Statistics

As of WED 6 JUL 2022 at 18:10

Rank	Name	Team	Goals	Shots	%	7m Shots	MP
89	Soumaya BELHADJ	TUN	2	6	33		4
89	Elhem GHERISSI	TUN	2	3	67		4
89	Angela JANKULOVSKA	MKD	2	6	33	1/1	4
89	Marija JANKULOVSKA	MKD	2	3	67		4
89	Joana Rafaela PIRES	POR	2	3	67		5
94	Nassima AMRANI	ALG	1	2	50		4
94	Rita BENTO DE CAMPOS	POR	1	1	100		5
94	Lucija BESEN	CRO	1	1	100		5
94	Margarida FAGUNDES MORAIS	POR	1	1	100		5
94	Bojana KOCEVA	MKD	1	1	100		4
94	Seynabou MBENGUE RODRIGUEZ	ESP	1	2	50		5
94	Roa MKADEM	TUN	1	1	100		4
94	Una OBRENOVIC	SRB	1	3	33		5
94	Saida REJEB	TUN	1	1	100		4
94	Mia TUPEK	CRO	1	1	100		5
94	Nika VOJNOVIC	CRO	1	2	50		5
105	Leila AROUDJ	ALG		4			4
105	Helena INDIC	SRB		2		0/1	5
105	Aleksandra KOLOVSKA	MKD		2			4
105	Lana MIJAILOVIC	SRB		1		0/1	5



## Individual Statistics

As of WED 6 JUL 2022 at 18:10

### ASSISTS

Rank	Name	Team	Assists	MP
1	Carmen CAMPOS COSTA	ESP	3	5
2	Katarina PAVLOVIC	CRO	1	5
2	Tena PETIKA	CRO	1	5



## Individual Statistics

As of WED 6 JUL 2022 at 18:10

### GOALS AND ASSISTS

Rank	Name	Team	Goal+Assi	Goals	Assists	MP
1	PAVLOVIC Katarina	CRO	45	44	1	5
2	CAMPOS COSTA Carmen	ESP	37	34	3	5
3	JOVOVIC Jovana	SRB	34	34		5
4	DUKOSKA Teodora	MKD	29	29		4
4	RODRIGUES SABINO Bebiana Catarina	POR	29	29		5
6	VUKAJLOVIC Aleksandra	SRB	24	24		5
7	ARROJERIA Esther	ESP	20	20		5
8	TURKOGLU Beyza Irem	TUR	19	19		4
9	ISKIT Asli	TUR	18	18		4
9	MAKHLOUFI Kenza	ALG	18	18		4
9	MINCIUNA Mihaela Oana	POR	18	18		5
12	HAMROUNI Amal	TUN	17	17		4
12	ZAZAI Sabrina	ALG	17	17		4
14	AYDIN Elif Sila	TUR	16	16		4
14	CLAUDINO FIGUEIREDO Carmen Filipa	POR	16	16		5
14	HACHANA EP KERKENI Sondes	TUN	16	16		4
14	JARAK Lana	CRO	16	16		5
14	POSAVEC Stela	CRO	16	16		5
19	JAPUNDZA Tena	CRO	15	15		5
19	KIPRIJANOVSKA Jovana	MKD	15	15		4
21	VEGUE I PENNA Ona	ESP	13	13		5
22	AOUIJ Fadwa	TUN	12	12		4
22	BARISIC Tina	CRO	12	12		5
22	KARACAM Beyza	TUR	12	12		4
22	RESENDE REBELO Luciana	POR	12	12		5
26	ALVAREZ TORRADO Elba	ESP	11	11		5
26	DUARTE Maria	POR	11	11		5
26	PETIKA Tena	CRO	11	10	1	5
26	VALDIVIA MONSERRAT Paula Maria	ESP	11	11		5
30	BOGUNOVIC Isidora	SRB	10	10		5
30	BOURI Fatma	TUN	10	10		4
30	CUADRADO SANCHEZ Elena	ESP	10	10		5
30	HAIMER Fatiha	ALG	10	10		4
30	MINOVSKA Sara	MKD	10	10		4
30	NUKOVIC Edita	SRB	10	10		5
30	SAHIN Yasemin	TUR	10	10		3
37	JOVANOVIC Marija	SRB	9	9		5
37	MASRI Aya	TUN	9	9		4
37	YELLES Loudmila Manel	ALG	9	9		4
40	BOJICIC Katarina	SRB	8	8		5
40	COSTA Mariana	POR	8	8		5
40	GASCO ARRANZ Clara	ESP	8	8		5
40	GOKTEPE AKGUN Nurceren	TUR	8	8		4



## Individual Statistics

As of WED 6 JUL 2022 at 18:10

Rank	Name	Team	Goal+Assi	Goals	Assists	MP
40	KOCEVA Borjana	MKD	8	8		4
40	RADEVIC Dunja	SRB	8	8		5
40	SPUGNINI SANTOME Alba Chiara	ESP	8	8		5
47	AZZI Sarah	ALG	7	7		4
47	CALISKAN Neslihan	TUR	7	7		4
47	DJATEVSKA Ivana	MKD	7	7		4
47	HERNANDEZ SELVA Laura	ESP	7	7		5
47	JOUINI Chaima	TUN	7	7		4
47	NUNES MONTEIRO Carolina	POR	7	7		5
47	SENVALD Sara	CRO	7	7		5
47	TAIBI Tasnime Shanez	ALG	7	7		4
55	BEN AMMAR Rania	TUN	6	6		4
55	DUARTE Neide	POR	6	6		5
55	GOMES DA COSTA Maria	ESP	6	6		5
55	KUCUKYILDIZ Fatma	TUR	6	6		4
55	SEDLOSKA Andrea	MKD	6	6		4
55	SUKUR Srna	SRB	6	6		5
55	TABAK Dunja	SRB	6	6		5
62	ARSENIEVSKA Ivana	MKD	5	5		4
62	MOUEDEB Jawaher	TUN	5	5		4
62	OZBOLLUK Merve	TUR	5	5		3
62	SIMARA Andrea	CRO	5	5		4
62	VELICKOVIC Teodora	SRB	5	5		5
67	BEN ABDALLAH Aya	TUN	4	4		4
67	BRITO Mariana	POR	4	4		5
67	DEMIRCELEN Ceren	TUR	4	4		4
67	DERRADJ Imen	ALG	4	4		4
67	DJABOUR Wafya	ALG	4	4		4
67	GASSAMA CISSOKHO Kaba	ESP	4	4		5
67	KARA Aysenur	TUR	4	4		4
67	MALEC Ana	CRO	4	4		5
67	MLADENOVSKA Iva	MKD	4	4		4
67	RIZOSKA Emilijana	MKD	4	4		4
67	VALERO JODAR Sara	ESP	4	4		5
67	ZELFANI Nada	TUN	4	4		4
79	BEBEK Josipa	CRO	3	3		5
79	BELOUHRANI Ferial	ALG	3	3		4
79	BOUKAABENE Meriem	ALG	3	3		4
79	CETKOVIC Natasa	SRB	3	3		5
79	DURDU Merve	TUR	3	3		4
79	GOKDEMIR Emine	TUR	3	3		4
79	GUSKIC Ema	CRO	3	3		5
79	LOIDI ETXANIZ June	ESP	3	3		5
79	SOZMEN Ece	TUR	3	3		4
79	YILMAZ Betul	TUR	3	3		4





## Individual Statistics

As of WED 6 JUL 2022 at 18:10

Rank	Name	Team	Goal+Assi	Goals	Assists	MP
89	BELHADJ Soumaya	TUN	2	2		4
89	GHERISSI Elhem	TUN	2	2		4
89	JANKULOVSKA Angela	MKD	2	2		4
89	JANKULOVSKA Marija	MKD	2	2		4
89	PIRES Joana Rafaela	POR	2	2		5
94	AMRANI Nassima	ALG	1	1		4
94	BENTO DE CAMPOS Rita	POR	1	1		5
94	BESEN Lucija	CRO	1	1		5
94	FAGUNDES MORAIS Margarida	POR	1	1		5
94	KOCEVA Bojana	MKD	1	1		4
94	MBENGUE RODRIGUEZ Seynabou	ESP	1	1		5
94	MKADEM Roa	TUN	1	1		4
94	OBRENOVIC Una	SRB	1	1		5
94	REJEB Saida	TUN	1	1		4
94	TUPEK Mia	CRO	1	1		5
94	VOJNOVIC Nika	CRO	1	1		5



## Individual Statistics

As of WED 6 JUL 2022 at 18:10

### STEALS

Rank	Name	Team	Total	Avg.	MP
1	Mariana BRITO	POR	1	0.2	5
1	Neide DUARTE	POR	1	0.2	5
1	Kaba GASSAMA CISSOKHO	ESP	1	0.2	5



## Individual Statistics

As of WED 6 JUL 2022 at 18:10

### BLOCKD SHOTS

Rank	Name	Team	Total	Avg.	MP
1	JOVANOVIC Marija	SRB	2	0.4	5
2	ARROJERIA Esther	ESP	1	0.2	5
2	HAMROUNI Amal	TUN	1	0.3	4
2	JOVOVIC Jovana	SRB	1	0.2	5
2	NUKOVIC Edita	SRB	1	0.2	5
2	PETIKA Tena	CRO	1	0.2	5
2	VUKAJLOVIC Aleksandra	SRB	1	0.2	5



## Individual Statistics

As of WED 6 JUL 2022 at 18:10

### PUNISHMENT

Rank	Name	Team	Points		BC	RC	2Min	YC	MP
			Avg.	Total					
1	Rania BEN AMMAR	TUN	3.0	12			6	0	4
1	Neslihan CALISKAN	TUR	3.0	12			6	0	4
3	Wafya DJABOUR	ALG	2.8	11			5	1	4
4	Sara SENVALD	CRO	2.6	13		1	3	2	5
5	Marija JOVANOVIC	SRB	2.4	12			5	2	5
5	Jovana JOVOVIC	SRB	2.4	12			6	0	5
7	Betul YILMAZ	TUR	2.3	9			4	1	4
8	Tena PETIKA	CRO	2.2	11			5	1	5
8	Aleksandra VUKAJLOVIC	SRB	2.2	11		1	3	0	5
10	Elena CUADRADO SANCHEZ	ESP	2.0	10			5	0	5
10	Sondes HACHANA EP KERKENI	TUN	2.0	8			4	0	4
10	Fatma KUCUKYILDIZ	TUR	2.0	8			4	0	4
13	Carmen Filipa CLAUDINO FIGUEIREDO	POR	1.8	9			4	1	5
14	Esther ARROJERIA	ESP	1.6	8			4	0	5
15	Feriel BELOUCHRANI	ALG	1.5	6			3	0	4
15	Fatma BOURI	TUN	1.5	6			3	0	4
15	Fatiha HAIMER	ALG	1.5	6			3	0	4
15	Jovana KIPRIJANOVSKA	MKD	1.5	6			3	0	4
15	Bojana KOCEVA	MKD	1.5	6			3	0	4
15	Aleksandra KOLOVSKA	MKD	1.5	6			3	0	4
15	Kenza MAKHLOUFI	ALG	1.5	6			3	0	4
22	Katarina PAVLOVIC	CRO	1.4	7			3	1	5
23	Tasnime Shanez TAIBI	ALG	1.3	5			2	1	4
24	Margarida FAGUNDES MORAIS	POR	1.2	6			3	0	5
24	Bebiana Catarina RODRIGUES SABINO	POR	1.2	6			3	0	5
26	Elif Sila AYDIN	TUR	1.0	4			2	0	4
26	Ceren DEMIRCELEN	TUR	1.0	4			2	0	4
26	Teodora DUKOSKA	MKD	1.0	4			2	0	4
26	Chaima JOUINI	TUN	1.0	4			2	0	4
26	June LOIDI ETXANIZ	ESP	1.0	5			2	1	5
26	Beyza Irem TURKOGLU	TUR	1.0	4			2	0	4
32	Elba ALVAREZ TORRADO	ESP	0.8	4			2	0	5
32	Tina BARISIC	CRO	0.8	4			2	0	5
32	Katarina BOJICIC	SRB	0.8	4			2	0	5
32	Mariana BRITO	POR	0.8	4			2	0	5
32	Kaba GASSAMA CISSOKHO	ESP	0.8	4			2	0	5
32	Emine GOKDEMIR	TUR	0.8	3			1	1	4
32	Ema GUSKIC	CRO	0.8	4			2	0	5
32	Mihaela Oana MINCIUNA	POR	0.8	4			2	0	5
32	Una OBRENOVIC	SRB	0.8	4			2	0	5
41	Nassima AMRANI	ALG	0.5	2			1	0	4
41	Fadwa AOUIJ	TUN	0.5	2			1	0	4
41	Ivana ARSENIEVSKA	MKD	0.5	2			1	0	4



## Individual Statistics

As of WED 6 JUL 2022 at 18:10

Rank	Name	Team	Points		BC	RC	2Min	YC	MP
			Avg.	Total					
41	Soumaya BELHADJ	TUN	0.5	2			1	0	4
41	Meriem BOUKAABENE	ALG	0.5	2			1	0	4
41	Nurceren GOKTEPE AKGUN	TUR	0.5	2			1	0	4
41	Asli ISKIT	TUR	0.5	2			1	0	4
41	Borjana KOCEVA	MKD	0.5	2			1	0	4
41	Sara MINOVSKA	MKD	0.5	2			1	0	4
41	Emilijana RIZOSKA	MKD	0.5	2			1	0	4
41	Andrea SEDLOSKA	MKD	0.5	2			1	0	4
41	Andrea SIMARA	CRO	0.5	2			1	0	4
41	Loudmila Manel YELLES	ALG	0.5	2			1	0	4
41	Nada ZELFANI	TUN	0.5	2			1	0	4
55	Natasa CETKOVIC	SRB	0.4	2			1	0	5
55	Mariana COSTA	POR	0.4	2			1	0	5
55	Clara GASCO ARRANZ	ESP	0.4	2			1	0	5
55	Maria GOMES DA COSTA	ESP	0.4	2				2	5
55	Tena JAPUNDZA	CRO	0.4	2			1	0	5
55	Lana JARAK	CRO	0.4	2			1	0	5
55	Edita NUKOVIC	SRB	0.4	2			1	0	5
55	Stela POSAVEC	CRO	0.4	2			1	0	5
55	Luciana RESENDE REBELO	POR	0.4	2			1	0	5
55	Mia TUPEK	CRO	0.4	2			1	0	5
65	Aya BEN ABDALLAH	TUN	0.3	1				1	4
65	Merve OZBOLLUK	TUR	0.3	1				1	3
67	Srna SUKUR	SRB	0.2	1				1	5
67	Sara VALERO JODAR	ESP	0.2	1				1	5

LEGEND

-  
-



## Goalkeepers Statistics

As of WED 6 JUL 2022 at 15:47

Including Game 44

### SHOTS

Minimum 20% of total shots received by team

Rank	Name	Team	%	Saves	Shots	MP
1	DURASINOVIC Jelena	SRB	42	43	103	5
2	FIGUEIRA DE GOIS Isabel Cristina	POR	40	23	58	4
3	BENABDELHAFID Nadia	ALG	38	3	8	3
4	GDOURA Omaima	TUN	34	11	32	4
4	VARGAS FERREIRA Jessica Romina	POR	34	37	109	5
4	WIGGINS SANCHO Nicole	ESP	34	28	83	5
7	BESEN Lucija	CRO	31	11	36	5
7	DURDU Merve	TUR	31	48	157	4
7	SIMIC Marija	SRB	31	26	83	5
10	GABOUR Naima	ALG	29	19	66	4
11	AALLA ROTAECHÉ Maddi	ESP	28	22	80	5
12	GOKER Yaren Berfe	TUR	27	3	11	4
13	JOVANOVSKA Marija	MKD	26	28	108	4
13	MKADEM Roa	TUN	26	24	92	4
13	SALHI Tinhinane	ALG	26	19	74	4
13	TUCAKOVIC Antonija	CRO	26	35	137	5
17	ROSA Matilde	POR	25	3	12	5
18	OMRANI Fadia	TUN	19	5	26	4
19	CHURLINOVSKA Matea	MKD	15	4	26	4



## Goalkeepers Statistics

As of WED 6 JUL 2022 at 15:47

Including Game 44

7m PENALTY SHOTS

Minimum 20% of total shots received by team

Rank	Name	Team	%	Saves	Shots	MP
1	SIMIC Marija	SRB	43	3	7	5
2	BESEN Lucija	CRO	33	2	6	5
2	ROSA Matilde	POR	33	1	3	5
4	DURASINOVIC Jelena	SRB	27	3	11	5
5	TUCAKOVIC Antonija	CRO	21	5	24	5
6	GDOURA Omaira	TUN	20	1	5	4
6	JOVANOVSKA Marija	MKD	20	2	10	4
8	GABOUR Naima	ALG	18	2	11	4
8	VARGAS FERREIRA Jessica Romina	POR	18	2	11	5
10	FIGUEIRA DE GOIS Isabel Cristina	POR	17	2	12	4
10	SALHI Tinhinane	ALG	17	2	12	4
12	DURDU Merve	TUR	5	1	19	4
13	AALLA ROTAECHÉ Maddi	ESP			4	5
13	CHURLINOVSKA Matea	MKD			6	4
13	MKADEM Roa	TUN			4	4
13	OMRANI Fadia	TUN			2	4
13	WIGGINS SANCHO Nicole	ESP			11	5

### LEGEND

% Efficiency

MP Matches Played



## Team Fair Play

As of WED 6 JUL 2022 at 15:46

Rank	Team	Points		BC	RC	2Min	YC	MP
		Avg.	Total					
1	TUR-Turkiye	13.3	53	0	0	23	7	4
2	SRB-Serbia	10.8	54	0	1	20	9	5
3	CRO-Croatia	10.6	53	0	1	20	8	5
4	ALG-Algeria	10.0	40	0	0	19	2	4
5	TUN-Tunisia	9.5	38	0	0	18	2	4
6	MKD-North Macedonia	8.5	34	0	0	16	2	4
7	ESP-Spain	7.6	38	0	0	16	6	5
8	POR-Portugal	6.8	34	0	0	16	2	5

### LEGEND

-  
-





## Competition Officials

As of WED 6 JUL 2022

Function	Name	Organisation	
Referee	Danijela SANDO KOVACEVIC	SRB - Serbia	
	Dragana JAKOVLJEVIC	SRB - Serbia	
	Youcef BELKHIRI	ALG - Algeria	
	Sid Ali HAMIDI	ALG - Algeria	
	Mihajlo ILIEVSKI	MKD - Rep. of North Macedonia	
	Metodija ILIEVSKI	MKD - Rep. of North Macedonia	
	DA SILVA L.	POR - Portugal	
	FERREIRA J.	POR - Portugal	
	Luis DIAZ FLORES GOMEZ	ESP - Spain	
	Enrique PEREZ GONZALEZ	ESP - Spain	
	Marta SA	POR - Portugal	
	Vania SA	POR - Portugal	
	Danijela KOVACEVIC	SRB - Serbia	
	Mustapha DECHE	ALG - Algeria	
	Mohamed GHOUARDA	ALG - Algeria	
	Boumediene KAHOUADJI	ALG - Algeria	
	Mohammed Amine FARSI	ALG - Algeria	
	Mahieddine GHOU	ALG - Algeria	
	Oussama CHERGUI	ALG - Algeria	
	Assem ELSAADANY	EGY - Egypt	
	IHF Officials	Lakhdar OULD KADA	ALG - Algeria
		Belhabib NASRI	ALG - Algeria
	IHF Timekeeper	Tahar NILI	ALG - Algeria
FATEH BENAISA		ALG - Algeria	
IHF Scorekeeper	YASSINE AGGOUN	ALG - Algeria	
	Djamel KARTALI	ALG - Algeria	
	Yamani BENCHIKH	ALG - Algeria	
	ZINEDINE FAHEM	ALG - Algeria	
	Kamel FELLAQ	ALG - Algeria	
	BENSALAH BELKACEM	ALG - Algeria	



ألعاب البحر الأبيض المتوسط  
MEDITERRANEAN GAMES  
JEUX MÉDITERRANÉENS  
du 25 juin au 06 juillet

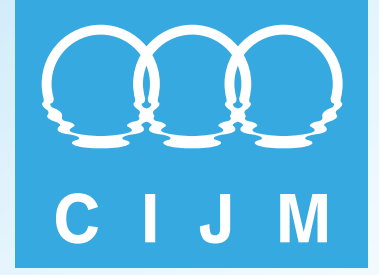

## Results Book



## Judo



**TOSYALI  
ALGERIE**

Fer et Acier

سوناطراي



sonarach



microplus  
DATA PROCESSING & TIMING  
[www.microplustiming.com](http://www.microplustiming.com)



## Competition Schedule

As of MON 4 JUL 2022

Date	Start time	Event/Cont
WED 29 JUN	11:00	Women 48kg Preliminary Rounds
		Women 52kg Preliminary Rounds
		Women 57kg Preliminary Rounds
		Men 60kg Preliminary Rounds
		Men 66kg Preliminary Rounds
	16:00	Women 48kg Final Block
		Women 52kg Final Block
		Women 57kg Final Block
		Men 60kg Final Block
		Men 66kg Final Block
THU 30 JUN	11:00	Women 63kg Preliminary Rounds
		Women 70kg Preliminary Rounds
		Men 73kg Preliminary Rounds
		Men 81kg Preliminary Rounds
		Men 81kg Preliminary Rounds
	16:00	Women 63kg Final Block
		Women 70kg Final Block
		Men 73kg Final Block
		Men 81kg Final Block
		Men 81kg Final Block
FRI 1 JUL	11:00	Women 78kg Preliminary Rounds
		Women 78+kg Preliminary Rounds
		Men 90kg Preliminary Rounds
		Men 100kg Preliminary Rounds
		Men 100+kg Preliminary Rounds
	16:00	Women 78kg Final Block
		Women 78+kg Final Block
		Men 90kg Final Block
		Men 100kg Final Block
		Men 100+kg Final Block



## Entry List by Country

As of MON 27 JUN 2022

Country Name	Date of Birth	Height m / ft	Weight Category	World Rank
<b>ALB - Albania</b>				
CULLHAJ Indrit	16 JAN 1997	1.71 / 5' 7"	Men 73kg	
RAMAJ Erson	21 MAY 1998	1.76 / 5' 9"	Men 90kg	
<b>ALG - Algeria</b>				
AISSAHINE Faiza	20 JUL 1993	1.75 / 5' 9"	Women 52kg	
ASSELAH Sonia	20 AUG 1991	1.78 / 5' 10"	Women 78+kg	
BELKADI Amina	10 NOV 1992	1.75 / 5' 9"	Women 63kg	
BELLAKEHAL Souad	23 MAR 1992	1.75 / 5' 9"	Women 70kg	
BELREKAA Mohamed-Sofiane	21 MAR 1991	1.75 / 5' 9"	Men 100+kg	
BENAMADI Abderrahmane	3 JUL 1985	1.75 / 5' 9"	Men 90kg	
BENAZOUG Aghiles-Imad	25 OCT 2001	1.75 / 5' 9"	Men 81kg	
BOUAMAR Mustapha Yasser	7 MAR 1998	1.75 / 5' 9"	Men 100kg	
CHERRAD Rachid	29 JAN 1994	1.75 / 5' 9"	Men 66kg	
DRIS Messaoud Redouane	13 SEP 2001	1.75 / 5' 9"	Men 73kg	
HALATA Yamina	4 SEP 1991	1.75 / 5' 9"	Women 57kg	
OULLAL Kaouthar	27 NOV 1990	1.80 / 5' 11"	Women 78kg	
REZZOUG Imene	12 SEP 1993	1.65 / 5' 5"	Women 48kg	
YAGOUBI Bilal	26 NOV 1998	1.75 / 5' 9"	Men 60kg	
<b>BIH - Bosnia and Herzegovina</b>				
CERIC Larisa	26 JAN 1991	1.75 / 5' 9"	Women 78+kg	
MILETIC Toni	12 JAN 1999	1.82 / 6' 0"	Men 90kg	
SAMARDZIC Aleksandra	23 SEP 1997	1.80 / 5' 11"	Women 70kg	
SAMARDZIC Andela	20 JUL 2000	1.65 / 5' 5"	Women 57kg	
VUCUREVIC Bozidar	18 JAN 2001	1.83 / 6' 0"	Men 81kg	
VUJICIC Vasilije	12 MAY 1999	1.90 / 6' 3"	Men 100+kg	
<b>CRO - Croatia</b>				
CVJETKO Lara	1 SEP 2001	1.73 / 5' 8"	Women 70kg	
KLACAR Robert	3 OCT 1999	1.68 / 5' 6"	Men 66kg	
KUMRIC Marko	18 MAR 1996	1.92 / 6' 4"	Men 100kg	
MARANIC Ivana	12 SEP 1991	1.81 / 5' 11"	Women 78+kg	
OBERAN Iva	17 NOV 1999	1.73 / 5' 8"	Women 63kg	
PAVIC Petrunjela	14 NOV 2000	1.80 / 5' 11"	Women 78kg	
PULJIZ Ana Viktorija	1 JAN 2002	1.61 / 5' 3"	Women 52kg	
SKALEC Marcel	28 JUL 1999	2.00 / 6' 7"	Men 100+kg	
<b>CYP - Cyprus</b>				
ANDREOU Kyprianos	17 AUG 2002	1.80 / 5' 11"	Men 73kg	



## Entry List by Country

As of MON 27 JUN 2022

Country Name	Date of Birth	Height m / ft	Weight Category	World Rank
ASVESTA Sofia	5 JUN 2000	1.52 / 5 ' 0 "	Women 52kg	
BALARJASHVILI Georgios	23 SEP 2002	1.67 / 5 ' 6 "	Men 66kg	
KOROTZIDIS Giorgos	19 NOV 1988	1.66 / 5 ' 5 "	Men 60kg	
<b>EGY - Egypt</b>				
ABDELMAWGOUD Mohamed	10 JUN 1994	1.67 / 5 ' 6 "	Men 66kg	
SAMY Yousry	15 APR 2003	1.68 / 5 ' 6 "	Men 60kg	
<b>ESP - Spain</b>				
BOUSBAA DAB Nisrin	29 AUG 2000	1.75 / 5 ' 9 "	Women 78+kg	
CABANA PEREZ Cristina	6 MAY 1993	1.65 / 5 ' 5 "	Women 63kg	
CHELARU GRIGORAS Irinel Vasile	31 MAY 1996	1.60 / 5 ' 3 "	Men 100+kg	
GAITERO MARTIN Alberto	3 JUL 1996	1.72 / 5 ' 8 "	Men 66kg	
GARRIGOS ROSA Francisco	9 DEC 1994	1.59 / 5 ' 3 "	Men 60kg	
LAPUERTA I COMAS Mireia	28 MAY 1999	1.62 / 5 ' 4 "	Women 48kg	
MOSAKHLISHVILI Tristani	31 DEC 1997	1.82 / 6 ' 0 "	Men 90kg	
PEREZ BOX Ana Isabel	29 DEC 1995	1.60 / 5 ' 3 "	Women 52kg	
PEREZ GOMEZ Lucia	16 SEP 1999	1.75 / 5 ' 9 "	Women 78kg	
RUIZ MURO Maria	3 FEB 1996	1.62 / 5 ' 4 "	Women 57kg	
SHERAZADISHVILI Nikoloz	19 FEB 1996	1.92 / 6 ' 4 "	Men 100kg	
TSUNODA ROUSTANT Ai	19 APR 2002	1.63 / 5 ' 4 "	Women 70kg	
URQUIZA SOLANA Alfonso	14 APR 1994	1.77 / 5 ' 10 "	Men 81kg	
<b>FRA - France</b>				
AGBEGNENOU Joris	27 MAR 2000		Men 100kg	
ANDREEV Guerman	22 SEP 1997	1.85 / 6 ' 1 "	Men 100+kg	
BUTTIGIEG Chloe	2 AUG 1997	1.70 / 5 ' 7 "	Women 78kg	
DAMIER Francis	24 DEC 2001	1.92 / 6 ' 4 "	Men 90kg	
DEVICTOR Chloe	8 SEP 2002	1.59 / 5 ' 3 "	Women 52kg	
GIBELLI Enzo	11 MAY 2000	1.74 / 5 ' 9 "	Men 73kg	
GNAMIEN Tizie	26 FEB 2000	1.78 / 5 ' 10 "	Men 81kg	
GOBERT Maxime	22 AUG 2001	1.75 / 5 ' 9 "	Men 66kg	
HAYME Coralie	26 JAN 2001	1.78 / 5 ' 10 "	Women 78+kg	
ISSOUFI Kaila	28 MAR 2001	1.68 / 5 ' 6 "	Women 70kg	
MERLIN Maxime	29 NOV 1997	1.64 / 5 ' 5 "	Men 60kg	
TURPIN Melodie	27 APR 2001	1.65 / 5 ' 5 "	Women 63kg	
VELLOZZI Ophelie	1 FEB 2000	1.65 / 5 ' 5 "	Women 57kg	
VIEU Melanie	16 DEC 1998	1.59 / 5 ' 3 "	Women 48kg	
<b>GRE - Greece</b>				



## Entry List by Country

As of MON 27 JUN 2022

Country Name	Date of Birth	Height m / ft	Weight Category	World Rank
PAPANIKOLAOU Panagiotis	6 JUN 2001	1.90 / 6 ' 3 "	Men 100+kg	
TELOTSIDOU Elisavet	8 NOV 1995	1.70 / 5 ' 7 "	Women 70kg	
TSELIDIS Theodoros	5 AUG 1996	1.81 / 5 ' 11 "	Men 90kg	
TSOUTLASVILI Michail	19 JUN 2002	1.78 / 5 ' 10 "	Men 73kg	
<b>ITA - Italy</b>				
AGRO SYLVAIN Lorenzo	24 JUL 1999		Men 100+kg	
BEDEL Kenny Komi	23 DEC 2000		Men 81kg	
BERGAMELLI Enrico	20 APR 2000		Men 100kg	
CAGGIANO Giulia	7 NOV 1995		Women 57kg	
D'ISANTO Nicolle	22 JAN 1999		Women 63kg	
ESPOSITO Martina	6 DEC 2001		Women 70kg	
GIORDA Francesca	30 MAR 1996		Women 52kg	
LOMBARDO Manuel	4 DEC 1998		Men 73kg	
PETITTO Sofia	17 JUN 1998		Women 48kg	
PIRAS Matteo	30 SEP 1993		Men 66kg	
PIRELLI Gennaro	21 AUG 2000	1.80 / 5 ' 11 "	Men 90kg	
POLITI Linda	28 AUG 1992		Women 78kg	
REA Diego	22 JUL 1998		Men 60kg	
TAVANO Asya	6 JUN 2002		Women 78+kg	
<b>KOS - Kosovo</b>				
FAZLIU Laura	28 SEP 2000	1.73 / 5 ' 8 "	Women 63kg	
GJAKOVA Akil	4 JAN 1996	1.74 / 5 ' 9 "	Men 73kg	
KRASNIQI Distria	10 DEC 1995	1.55 / 5 ' 1 "	Women 52kg	
KUKA Loriana	5 APR 1997	1.77 / 5 ' 10 "	Women 78kg	
KULLASHI Arber	13 MAY 2000	1.76 / 5 ' 9 "	Men 81kg	
LOXHA Flaka	5 APR 1999	1.65 / 5 ' 5 "	Women 57kg	
MUMINOVIQ Erza	3 MAY 2002	1.55 / 5 ' 1 "	Women 48kg	
ZEKAJ Shpati	23 APR 2000	1.93 / 6 ' 4 "	Men 100kg	
<b>LBA - Libya</b>				
ABUSHAGUR Abdulati	14 AUG 1993	1.80 / 5 ' 11 "	Men 73kg	
<b>LBN - Lebanon</b>				
MOUSSA Ghady	25 NOV 2001	1.77 / 5 ' 10 "	Men 73kg	
SAGAIPOV Caramnob	1 JAN 1997	1.80 / 5 ' 11 "	Men 90kg	
TARABAY Natacha	21 SEP 2004	1.80 / 5 ' 11 "	Women 78kg	
<b>MAR - Morocco</b>				
BASSOU Issam	12 OCT 1998	1.68 / 5 ' 6 "	Men 60kg	



## Entry List by Country

As of MON 27 JUN 2022

Country Name	Date of Birth	Height m / ft	Weight Category	World Rank
BOUSHITA Abderrahmane	5 SEP 1997	0.66 / 2 ' 2 "	Men 66kg	
DOUKKALI Hassan	18 AUG 2002	1.75 / 5 ' 9 "	Men 73kg	
EDDINARI Chaimae	19 JUL 1999	1.60 / 5 ' 3 "	Women 48kg	
ESSERYRY Zouhair	10 SEP 2000	1.80 / 5 ' 11 "	Men 100+kg	
HARACHI Sarah	17 JAN 1996	1.65 / 5 ' 5 "	Women 63kg	
IRAQUI Soumiya	19 MAR 1996	1.60 / 5 ' 3 "	Women 52kg	
MOUTII Achraf	4 DEC 1996	1.80 / 5 ' 11 "	Men 81kg	
YATIM Hafsa	30 JAN 1998	1.70 / 5 ' 7 "	Women 78kg	
<b>MK - Rep. of North Macedonia</b>				
CHAKAROVSKI Andrej	24 DEC 2001	1.84 / 6 ' 0 "	Men 90kg	
SHERIFOVSKI Edi	28 AUG 2001	1.81 / 5 ' 11 "	Men 81kg	
<b>MNE - Montenegro</b>				
PEKOVIC Jovana	16 JAN 1998	1.65 / 5 ' 5 "	Women 78kg	
<b>MO - Monaco</b>				
GADEAU Marvin	6 SEP 2000	1.86 / 6 ' 1 "	Men 100+kg	
GRINDA Nicolas	19 APR 1997	1.87 / 6 ' 2 "	Men 90kg	
<b>POR - Portugal</b>				
Brites Diogo Filipe	3 SEP 1998	1.88 / 6 ' 2 "	Men 100kg	
BRITO Raquel Nunes	7 JUN 2002	1.70 / 5 ' 7 "	Women 48kg	
CRISOSTOMO Joana Cristina	31 OCT 2001	1.72 / 5 ' 8 "	Women 70kg	
FERNANDES Bernardo	22 FEB 2003	1.71 / 5 ' 7 "	Men 66kg	
GOMES Wilsa	25 OCT 1997	1.64 / 5 ' 5 "	Women 63kg	
PIRES Ricardo	11 SEP 2002	1.70 / 5 ' 7 "	Men 60kg	
RODRIGUES Manuel	27 AUG 2000	1.85 / 6 ' 1 "	Men 81kg	
SANTOS Teresa	23 MAR 2002	1.64 / 5 ' 5 "	Women 57kg	
<b>SLO - Slovenia</b>				
DRAGIC Vito	7 JAN 1993	1.98 / 6 ' 6 "	Men 100+kg	
HOJAK Martin	16 NOV 1997	1.75 / 5 ' 9 "	Men 73kg	
LACKOVIC Narsej	13 JAN 1996	1.84 / 6 ' 0 "	Men 90kg	
LOBNIK Metka	9 APR 2001	1.68 / 5 ' 6 "	Women 78kg	
POGACNIK Anka	23 DEC 1991	1.70 / 5 ' 7 "	Women 70kg	
STANGAR Anja	6 JAN 1996	1.63 / 5 ' 4 "	Women 52kg	
STANGAR Marusa	31 JAN 1998	1.59 / 5 ' 3 "	Women 48kg	
STARKEL David	16 JUN 1996	1.69 / 5 ' 7 "	Men 60kg	
TORKAR Urška	10 SEP 1997	1.75 / 5 ' 9 "	Women 78+kg	
<b>SRB - Serbia</b>				



## Entry List by Country

As of MON 27 JUN 2022

Country Name	Date of Birth	Height m / ft	Weight Category	World Rank
BRASNJOVIC Darko	20 AUG 1999		Men 90kg	
BUNCIC Strahinja	5 JAN 1996		Men 66kg	
KUKOLJ Aleksandar	9 SEP 1991		Men 100kg	
NIKOLIC Milica	7 NOV 1994		Women 48kg	
PERISIC Marica	25 JAN 2000		Women 57kg	
PETROVIC Nadezda	11 DEC 1999		Women 52kg	
ZABIC Milica	12 APR 1994		Women 78+kg	
<b>SYR - Syrian Arab Republic</b>				
AL REFAI Suleiman	1 APR 1993	1.60 / 5 ' 3 "	Men 60kg	
BAYAN Hasan	29 AUG 2001	1.75 / 5 ' 9 "	Men 73kg	
<b>TUN - Tunisia</b>				
BEDIOUI Oumaima	27 JAN 1998	1.55 / 5 ' 1 "	Women 48kg	
BEN AMMAR Abdelaziz	6 JUL 1992	1.81 / 5 ' 11 "	Men 90kg	
BEN CHALBI Aleddine	9 MAY 2001	1.75 / 5 ' 9 "	Men 73kg	
BEN GHARES Koussay	31 MAR 2003	1.86 / 6 ' 1 "	Men 100kg	
BJAOUI Mariem	29 OCT 1996	1.72 / 5 ' 8 "	Women 63kg	
CHEIKH ROUHOU Nihel	5 JAN 1987	1.76 / 5 ' 9 "	Women 78+kg	
DHOUBI Fraj	14 SEP 1991	1.72 / 5 ' 8 "	Men 60kg	
HAJJI Wajdi	20 NOV 1999	1.78 / 5 ' 10 "	Men 81kg	
HDIOUECH Wahib	9 SEP 2002	1.88 / 6 ' 2 "	Men 100+kg	
LANDOLSI Nihel	1 JUL 1995	1.81 / 5 ' 11 "	Women 70kg	
<b>TUR - Turkey</b>				
AKDENIZ Minel	30 JUN 1999		Women 70kg	
AKKUS Mhirc	1 JUN 2000		Men 60kg	
ALBAYRAK Vedat	4 JUN 1993		Men 81kg	
BOZKURT Hasret	7 MAR 2001		Women 57kg	
DEMIREL Umalt	4 JAN 2001		Men 73kg	
ERTUG Munir	11 SEP 2003		Men 100+kg	
KARABULUT Buketnur	1 MAY 2003		Women 52kg	
SAYIT Kayra	13 FEB 1988		Women 78+kg	
SENTURK Gul Kader	8 JAN 1996		Women 48kg	
SISMANLAR Mert	17 SEP 2000		Men 100kg	
TOKTAY Ejder	21 FEB 2001		Men 66kg	
YEKSAN Ayten Mediha	17 MAR 2002		Women 63kg	
YILMAZ Nurcan	7 OCT 1990		Women 78kg	
ZGANK Mihael	1 FEB 1994		Men 90kg	





## Number of Entries by Country

As of WED 29 JUN 2022

Country	Entries by Event														Number of Athletes		
	Men							Women							Men	Women	Total
	60	66	73	81	90	100	100+	48	52	57	63	70	78	78+			
ALB			1		1										2	0	2
ALG	1	1	1	1	1	1	1	1	1	1	1	1	1	1	7	7	14
BIH				1	1		1			1		1		1	3	3	6
CRO		1				1	1		1		1	1	1	1	3	5	8
CYP	1	1	1						1						3	1	4
EGY	1	1													2	0	2
ESP	1	1		1	1	1	1	1	1	1	1	1	1	1	6	7	13
FRA	1	1	1	1	1	1	1	1	1	1	1	1	1	1	7	7	14
GRE			1		1		1					1			3	1	4
ITA	1	1	1	1	1	1	1	1	1	1	1	1	1	1	7	7	14
KOS			1	1		1		1	1	1	1		1		3	5	8
LBA			1												1	0	1
LBN			1		1								1		2	1	3
MAR	1	1	1	1			1	1	1		1		1		5	4	9
MKD				1	1										2	0	2
MNE													1		0	1	1
MON					1		1								2	0	2
POR	1	1		1		1		1		1	1	1			4	4	8
SLO	1		1		1		1	1	1			1	1	1	4	5	9
SRB		1			1	1		1	1	1				1	3	4	7
SYR	1		1												2	0	2
TUN	1		1	1	1	1	1	1			1	1		1	6	4	10
TUR	1	1	1	1	1	1	1	1	1	1	1	1	1	1	7	7	14
<b>Total: 23</b>	<b>12</b>	<b>11</b>	<b>14</b>	<b>11</b>	<b>14</b>	<b>10</b>	<b>12</b>	<b>11</b>	<b>11</b>	<b>9</b>	<b>10</b>	<b>11</b>	<b>11</b>	<b>10</b>	<b>84</b>	<b>73</b>	<b>157</b>



## Medallists by Weight Category

As of FRI 1 JUL 2022 at 17:52

After 14 of 14 Events

Event	Date	Medal	Name	Country Code
Women 48kg	WED 29 JUN 2022	GOLD	VIEU Melanie	FRA
		SILVER	NIKOLIC Milica	SRB
		BRONZE	STANGAR Marusa	SLO
		BRONZE	BEDIOUI Oumaima	TUN
Women 52kg	WED 29 JUN 2022	GOLD	KRASNIQI Distria	KOS
		SILVER	PULJIZ Ana Viktorija	CRO
		BRONZE	DEVICTOR Chloe	FRA
		BRONZE	PEREZ BOX Ana Isabel	ESP
Women 57kg	WED 29 JUN 2022	GOLD	PERISIC Marica	SRB
		SILVER	CAGGIANO Giulia	ITA
		BRONZE	SAMARDZIC Andela	BIH
		BRONZE	LOXHA Flaka	KOS
Women 63kg	THU 30 JUN 2022	GOLD	FAZLIU Laura	KOS
		SILVER	CABANA PEREZ Cristina	ESP
		BRONZE	BELKADI Amina	ALG
		BRONZE	OBERAN Iva	CRO
Women 70kg	THU 30 JUN 2022	GOLD	TSUNODA ROUSTANT Ai	ESP
		SILVER	LANDOLSI Nihel	TUN
		BRONZE	TELSIDOU Elisavet	GRE
		BRONZE	ESPOSITO Martina	ITA
Women 78+kg	FRI 1 JUL 2022	GOLD	SAYIT Kayra	TUR
		SILVER	CHEIKH ROUHOU Nihel	TUN
		BRONZE	CERIC Larisa	BIH
		BRONZE	HAYME Coralie	FRA
Women 78kg	FRI 1 JUL 2022	GOLD	KUKA Loriana	KOS
		SILVER	BUTTIGIEG Chloe	FRA
		BRONZE	PAVIC Petruniela	CRO
		BRONZE	YILMAZ Nurcan	TUR
Men 100+kg	FRI 1 JUL 2022	GOLD	DRAGIC Vito	SLO
		SILVER	BELREKAA Mohamed-Sofiane	ALG
		BRONZE	AGRO SYLVAIN Lorenzo	ITA
		BRONZE	HADIOUECH Wahib	TUN
Men 100kg	FRI 1 JUL 2022	GOLD	SHERAZADISHVILI Nikoloz	ESP
		SILVER	BOUAMAR Mustapha Yasser	ALG
		BRONZE	AGBEGNENOU Joris	FRA
		BRONZE	KUKOLJ Aleksandar	SRB
Men 60kg	WED 29 JUN 2022	GOLD	GARRIGOS ROSA Francisco	ESP
		SILVER	DHOUBI Frai	TUN
		BRONZE	SAMY Youssry	EGY
		BRONZE	BASSOU Issam	MAR
Men 66kg	WED 29 JUN 2022	GOLD	ABDELMAWGOUD Mohamed	EGY
		SILVER	PIRAS Matteo	ITA
		BRONZE	GOBERT Maxime	FRA
		BRONZE	BUNCIC Strahinja	SRB



## Medallists by Weight Category

As of FRI 1 JUL 2022 at 17:52

After 14 of 14 Events

Event	Date	Medal	Name	Country Code
Men 73kg	THU 30 JUN 2022	GOLD	DRIS Messaoud Redouane	ALG
		SILVER	DOUKKALI Hassan	MAR
		BRONZE	BEN CHALBI Aledine	TUN
		BRONZE	GJAKOVA Akil	KOS
Men 81kg	THU 30 JUN 2022	GOLD	ALBAYRAK Vedat	TUR
		SILVER	BEDEL Kenny Komi	ITA
		BRONZE	URQUIZA SOLANA Alfonso	ESP
		BRONZE	GNAMIEN Tizie	FRA
Men 90kg	FRI 1 JUL 2022	GOLD	ZGANK Mihael	TUR
		SILVER	TSELIDIS Theodoros	GRE
		BRONZE	MILETIC Toni	BIH
		BRONZE	MOSAKHLISHVILI Tristani	ESP



## Medal Standings

As of FRI 1 JUL 2022 at 17:53

After 14 of 14 Events

Rank	Ctry	Men				Women				Total				Rank by total
		G	S	B	Tot	G	S	B	Tot	G	S	B	Tot	
1	ESP - Spain	2		2	4	1	1	1	3	3	1	3	7	= 1
2	KOS - Kosovo			1	1	3		1	4	3		2	5	= 4
3	TUR - Turkiye	2			2	1		1	2	3		1	4	= 6
4	ALG - Algeria	1	2		3			1	1	1	2	1	4	= 6
5	FRA - France			3	3	1	1	2	4	1	1	5	7	= 1
6	SRB - Serbia			2	2	1	1		2	1	1	2	4	= 6
7	EGY - Egypt	1		1	2					1		1	2	= 11
7	SLO - Slovenia	1			1			1	1	1		1	2	= 11
9	TUN - Tunisia		1	2	3		2	1	3		3	3	6	3
10	ITA - Italy		2	1	3		1	1	2		3	2	5	= 4
11	CRO - Croatia						1	2	3		1	2	3	= 9
12	GRE - Greece		1		1			1	1		1	1	2	= 11
12	MAR - Morocco		1	1	2						1	1	2	= 11
14	BIH - Bosnia and Herzegovina			1	1			2	2			3	3	= 9
	<b>Total:</b>	<b>7</b>	<b>7</b>	<b>14</b>	<b>28</b>	<b>7</b>	<b>7</b>	<b>14</b>	<b>28</b>	<b>14</b>	<b>14</b>	<b>28</b>	<b>56</b>	

### LEGEND

= Equal sign indicates that two or more  
 Tot Total  
 B Bronze  
 G Gold  
 S Silver



## Entry List by Weight Category

Ctry	Name	Date of Birth	Height m / ft	World Rank
ALG - Algeria	YAGOUBI Bilal	26 NOV 1998	1.75 / 5' 9"	
CYP - Cyprus	KOROTZIDIS Giorgos	19 NOV 1988	1.66 / 5' 5"	
EGY - Egypt	SAMY Youssry	15 APR 2003	1.68 / 5' 6"	
ESP - Spain	GARRIGOS ROSA Francisco	9 DEC 1994	1.59 / 5' 3"	
FRA - France	MERLIN Maxime	29 NOV 1997	1.64 / 5' 5"	
ITA - Italy	REA Diego	22 JUL 1998		
MAR - Morocco	BASSOU Issam	12 OCT 1998	1.68 / 5' 6"	
POR - Portugal	PIRES Ricardo	11 SEP 2002	1.70 / 5' 7"	
SLO - Slovenia	STARKEL David	16 JUN 1996	1.69 / 5' 7"	
SYR - Syrian Arab Republic	AL REFAI Suleiman	1 APR 1993	1.60 / 5' 3"	
TUN - Tunisia	DHOUBI Fraj	14 SEP 1991	1.72 / 5' 8"	
TUR - Turkiye	AKKUS Mihrac	1 JUN 2000		

TotJudoka: 12

Note:

JUDM60KG-----\_32C 1.0

Report Created MON 27 JUN 2022 18:40

Page 1 / 1

Data Processing and Timing by Microplus - [www.microplustiming.com](http://www.microplustiming.com)



## Draw Sheet

As of WED 29 JUN 2022 at 16:52

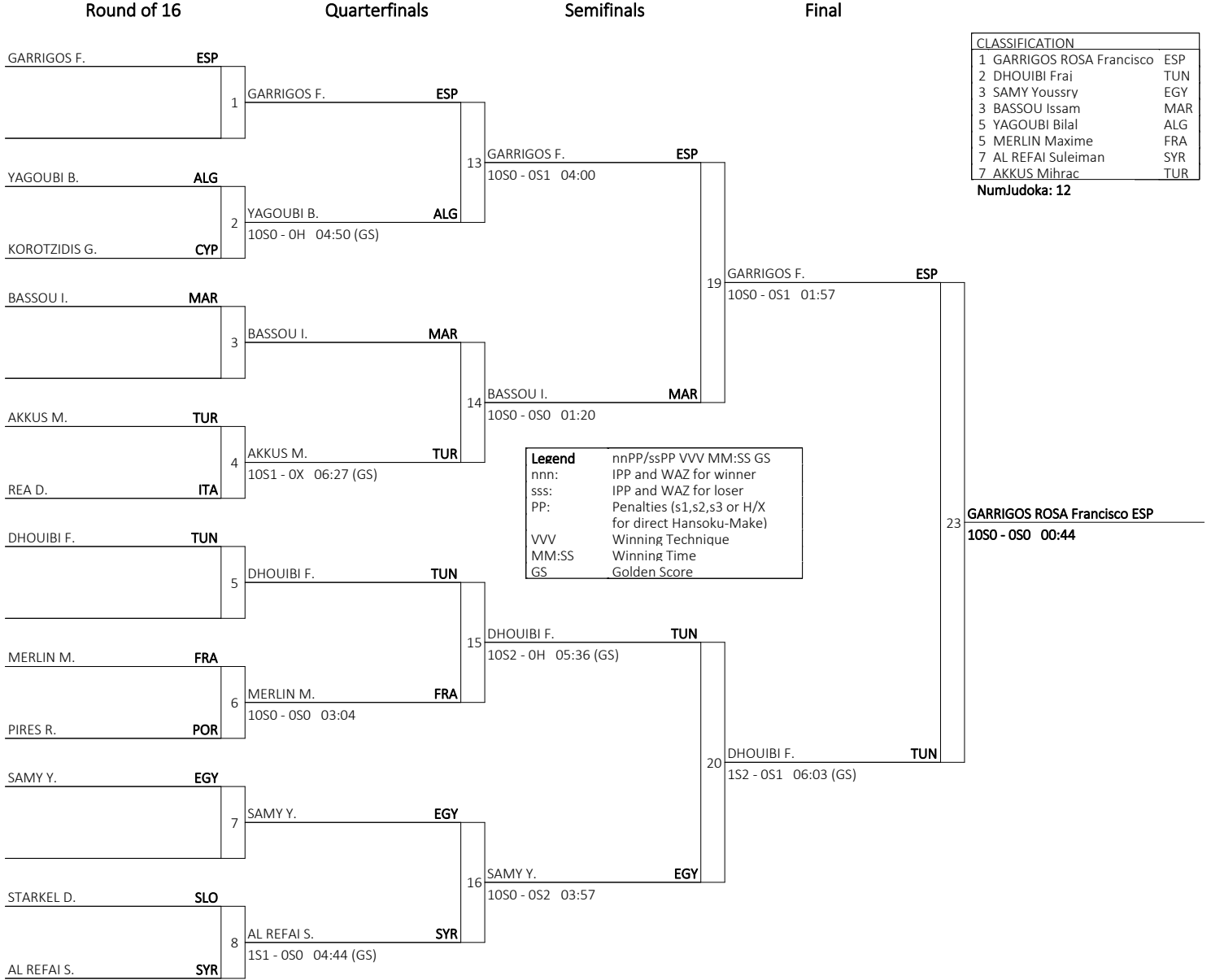

CLASSIFICATION		
1	GARRIGOS ROSA Francisco	ESP
2	DHOUBI Frai	TUN
3	SAMY Youssry	EGY
3	BASSOU Issam	MAR
5	YAGOUBI Bilal	ALG
5	MERLIN Maxime	FRA
7	AL REFAI Suleiman	SYR
7	AKKUS Mihrac	TUR

NumJudoka: 12



## Draw Sheet

Repechage (8)

Repechage

Bronze Contest

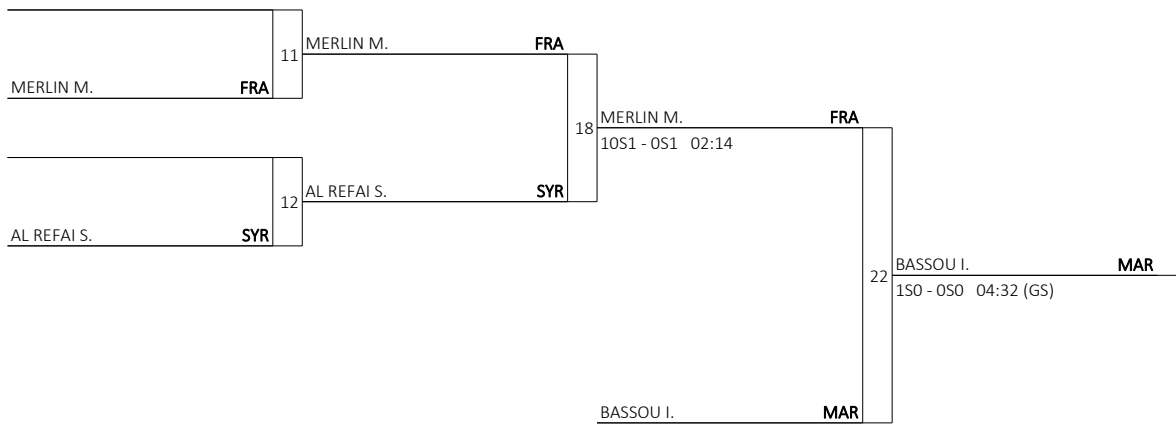
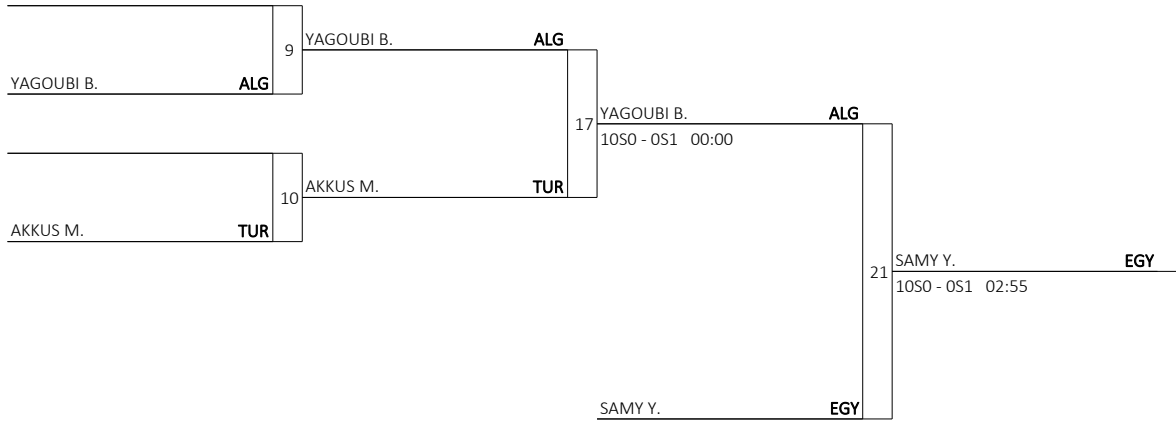



## Results summary

As of WED 29 JUN 2022

Rank	Name	Ctry	Medal
1	GARRIGOS ROSA Francisco	ESP	GOLD
2	DHOUBI Fraj	TUN	SILVER
3	SAMY Youssry	EGY	BRONZE
3	BASSOU Issam	MAR	BRONZE
5	YAGOUBI Bilal	ALG	
5	MERLIN Maxime	FRA	
7	AL REFAI Suleiman	SYR	
7	AKKUS Mhrac	TUR	
9	KOROTZIDIS Giorgos	CYP	
9	REA Diego	ITA	
9	PIRES Ricardo	POR	
9	STARKEL David	SLO	

### LEGEND

**DNS** Did not start

**DQB** Disqualified for unsportsmanlike beha **DSQ** Disqualified





## Entry List by Weight Category

Ctry	Name	Date of Birth	Height m / ft	World Rank
ALG - Algeria	CHERRAD Rachid	29 JAN 1994	1.75 / 5' 9"	
CRO - Croatia	KLACAR Robert	3 OCT 1999	1.68 / 5' 6"	
CYP - Cyprus	BALARJIASHVILI Georgios	23 SEP 2002	1.67 / 5' 6"	
EGY - Egypt	ABDELMAWGOUD Mohamed	10 JUN 1994	1.67 / 5' 6"	
ESP - Spain	GAITERO MARTIN Alberto	3 JUL 1996	1.72 / 5' 8"	
FRA - France	GOBERT Maxime	22 AUG 2001	1.75 / 5' 9"	
ITA - Italy	PIRAS Matteo	30 SEP 1993		
MAR - Morocco	BOUSHITA Abderrahmane	5 SEP 1997	0.66 / 2' 2"	
POR - Portugal	FERNANDES Bernardo	22 FEB 2003	1.71 / 5' 7"	
SRB - Serbia	BUNCIC Strahinja	5 JAN 1996		
TUR - Turkiye	TOKTAY Ejder	21 FEB 2001		

TotJudoka: 11

Note:

JUDM66KG-----\_32C 1.0

Report Created MON 27 JUN 2022 18:40

Page 1 / 1

Data Processing and Timing by Microplus - [www.microplustiming.com](http://www.microplustiming.com)



## Draw Sheet

As of WED 29 JUN 2022 at 17:28

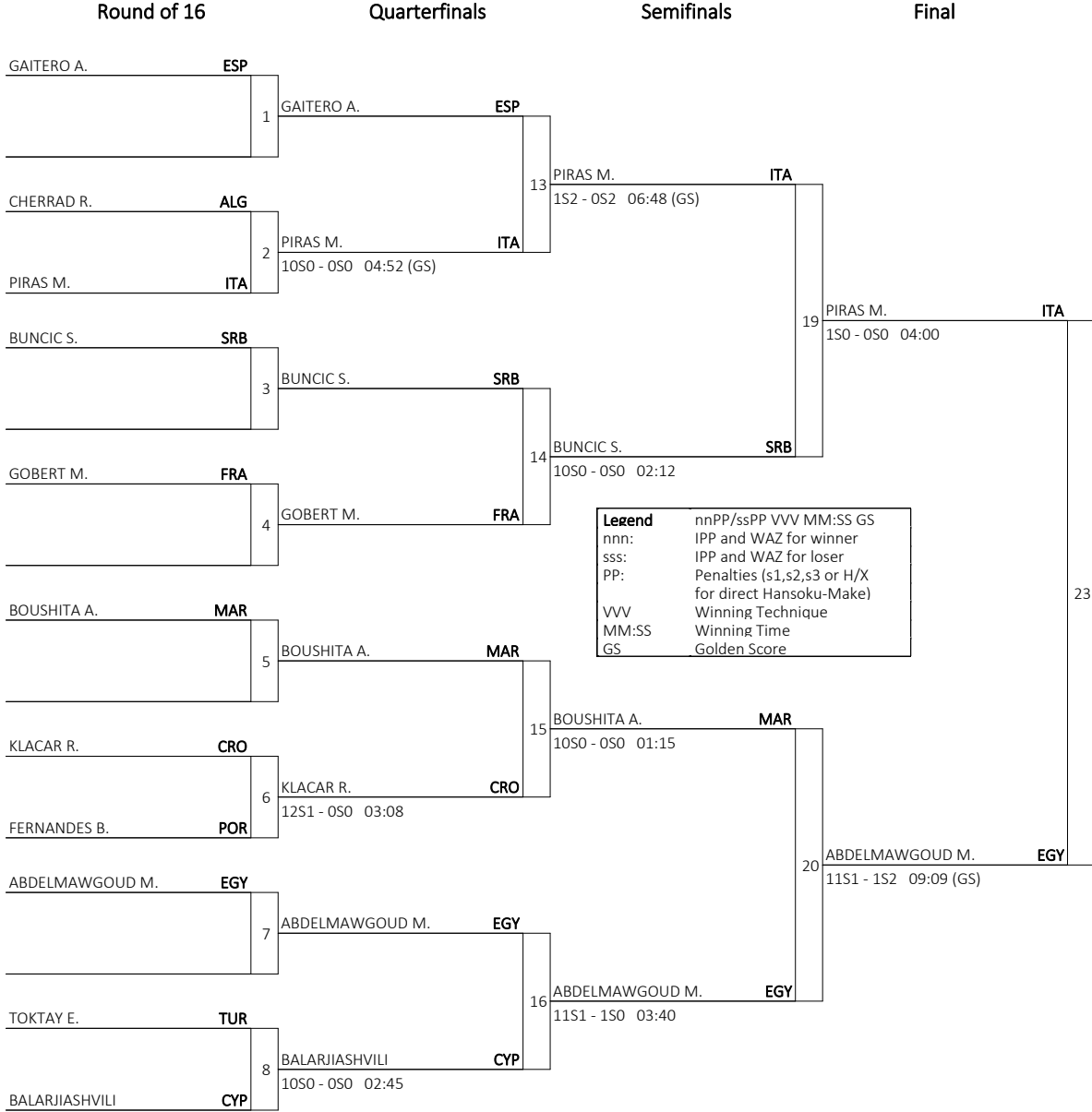

CLASSIFICATION	
1	ABDELMAWGOUD Moham EGY
2	PIRAS Matteo ITA
3	GOBERT Maxime FRA
3	BUNCIC Strahinja SRB
5	BOUSHITA Abderrahmane MAR
5	KLACAR Robert CRO
7	BALARJIASHVILI Georgios CYP
7	GAITERO MARTIN Alberto ESP

NumJudoka: 11

Legend	
nnPP/ssPP VVV MM:SS GS	
nnn:	IPP and WAZ for winner
sss:	IPP and WAZ for loser
PP:	Penalties (s1,s2,s3 or H/X for direct Hansoku-Make)
VVV	Winning Technique
MM:SS	Winning Time
GS	Golden Score



## Draw Sheet

Repechage (8)

Repechage

Bronze Contest

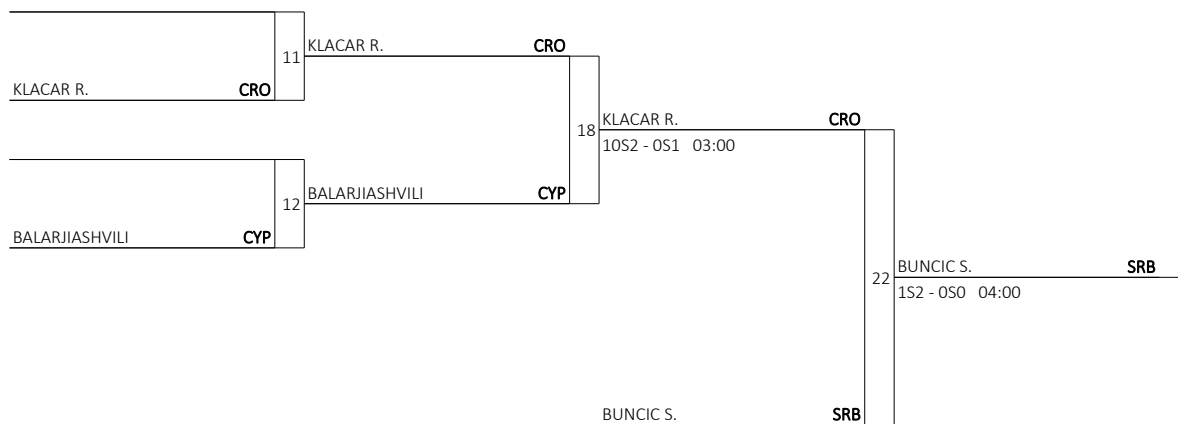
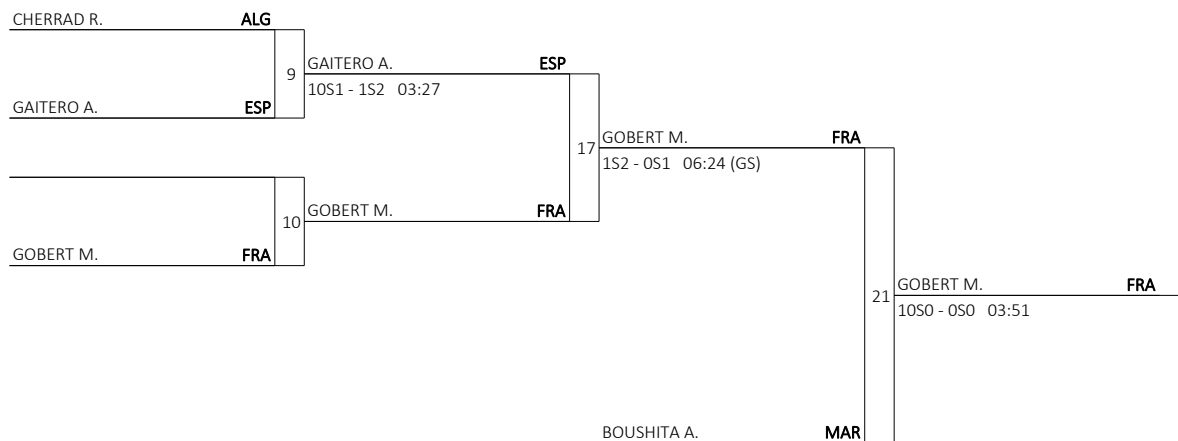



## Results summary

As of WED 29 JUN 2022

Rank	Name	Ctry	Medal
1	ABDELMAWGOUD Mohamed	EGY	GOLD
2	PIRAS Matteo	ITA	SILVER
3	GOBERT Maxime	FRA	BRONZE
3	BUNCIC Strahinja	SRB	BRONZE
5	BOUSHITA Abderrahmane	MAR	
5	KLACAR Robert	CRO	
7	BALARJASHVILI Georgios	CYP	
7	GAITERO MARTIN Alberto	ESP	
9	CHERRAD Rachid	ALG	
9	FERNANDES Bernardo	POR	
9	TOKTAY Ejder	TUR	

### LEGEND

**DNS** Did not start

**DQB** Disqualified for unsportsmanlike beha **DSQ** Disqualified



## Entry List by Weight Category

Ctry	Name	Date of Birth	Height m / ft	World Rank
ALB - Albania	CULLHAJ Indrit	16 JAN 1997	1.71 / 5' 7"	
ALG - Algeria	DRIS Messaoud Redouane	13 SEP 2001	1.75 / 5' 9"	
CYP - Cyprus	ANDREOU Kyprianos	17 AUG 2002	1.80 / 5' 11"	
FRA - France	GIBELLI Enzo	11 MAY 2000	1.74 / 5' 9"	
GRE - Greece	TSOUTLASVILI Michail	19 JUN 2002	1.78 / 5' 10"	
ITA - Italy	LOMBARDO Manuel	4 DEC 1998		
KOS - Kosovo	GJAKOVA Akil	4 JAN 1996	1.74 / 5' 9"	
LBA - Libya	ABUSHAGUR Abdulati	14 AUG 1993	1.80 / 5' 11"	
LBN - Lebanon	MOUSSA Ghady	25 NOV 2001	1.77 / 5' 10"	
MAR - Morocco	DOUKKALI Hassan	18 AUG 2002	1.75 / 5' 9"	
SLO - Slovenia	HOJAK Martin	16 NOV 1997	1.75 / 5' 9"	
SYR - Syrian Arab Republic	BAYAN Hasan	29 AUG 2001	1.75 / 5' 9"	
TUN - Tunisia	BEN CHALBI Aleddine	9 MAY 2001	1.75 / 5' 9"	
TUR - Turkiye	DEMIREL Umalt	4 JAN 2001		

TotJudoka: 14

Note:

JUDM73KG-----\_32C 1.0

Report Created MON 27 JUN 2022 18:40

Page 1 / 1

Data Processing and Timing by Microplus - www.microplustiming.com



## Draw Sheet

As of THU 30 JUN 2022 at 16:49

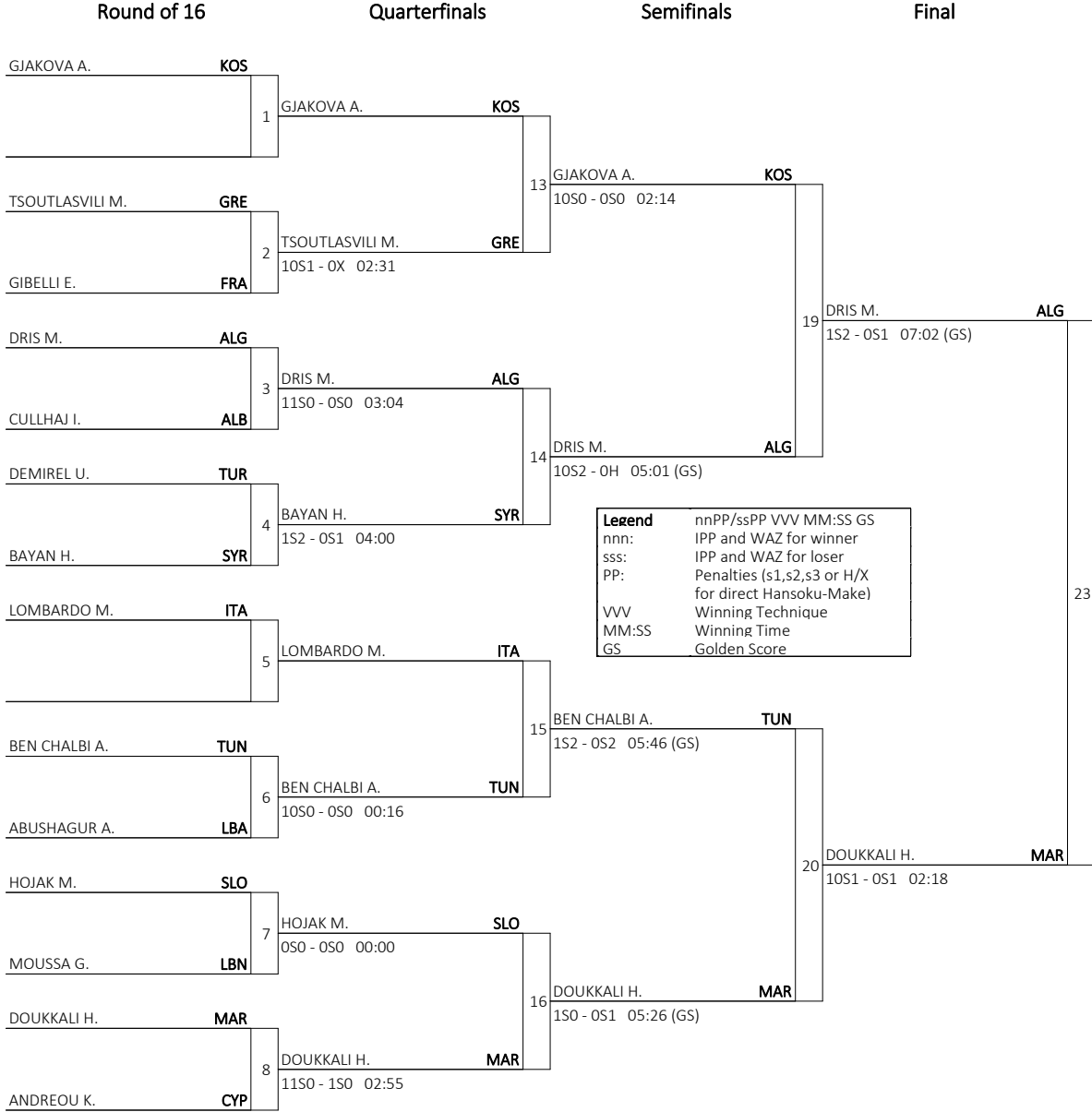

CLASSIFICATION		
1	DRIS Messaoud Redouane	ALG
2	DOUKKALI Hassan	MAR
3	BEN CHALBI Aledidine	TUN
3	GJAKOVA Akil	KOS
5	TSOUTLASVILI Michail	GRE
5	LOMBARDO Manuel	ITA
7	HOJAK Martin	SLO
7	BAYAN Hasan	SYR

NumJudoka: 14

**Legend**

- nnPP/ssPP VVV MM:SS GS
- nnn: IPP and WAZ for winner
- sss: IPP and WAZ for loser
- PP: Penalties (s1,s2,s3 or H/X for direct Hansoku-Make)
- VVV Winning Technique
- MM:SS Winning Time
- GS Golden Score



## Draw Sheet

Repechage (8)

Repechage

Bronze Contest

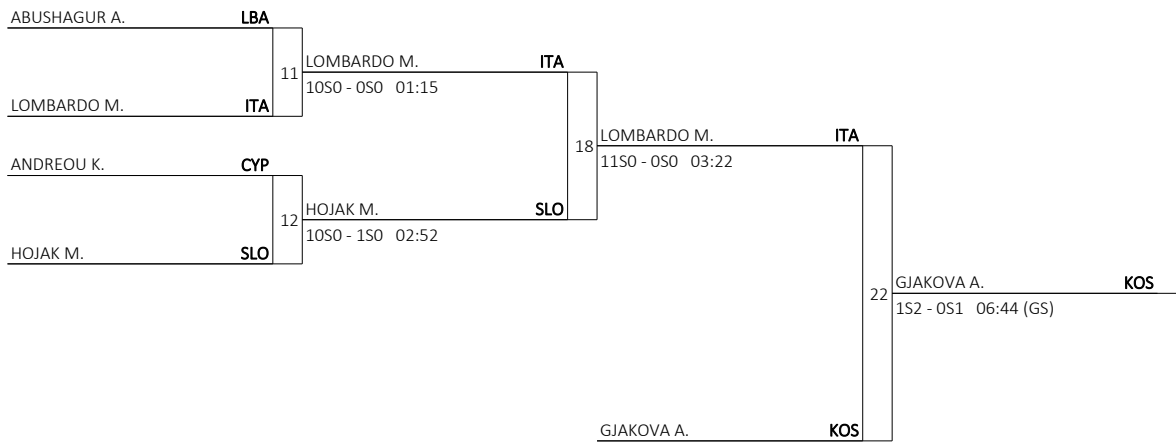
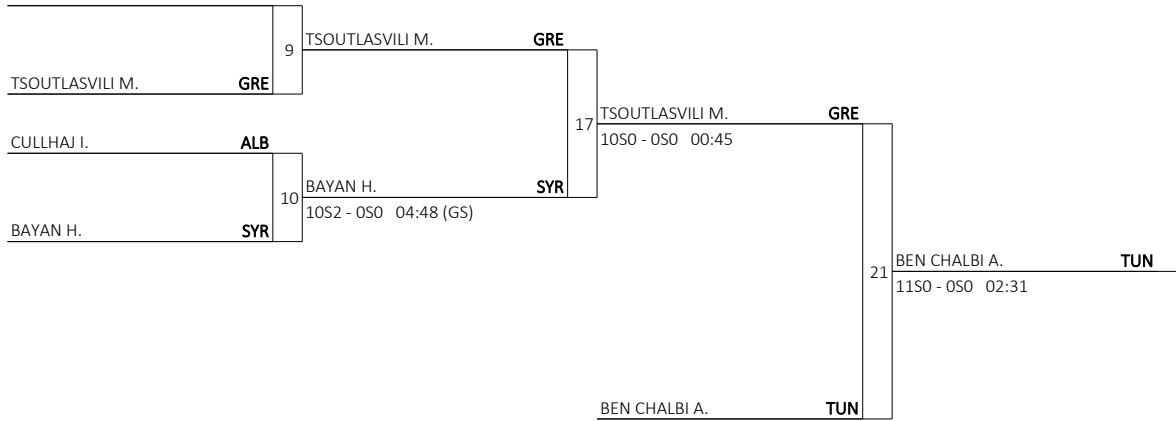



## Results summary

As of THU 30 JUN 2022

Rank	Name	Ctry	Medal
	MOUSSA Ghady	LBN	
1	DRIS Messaoud Redouane	ALG	GOLD
2	DOUKKALI Hassan	MAR	SILVER
3	BEN CHALBI Aleddine	TUN	BRONZE
3	GJAKOVA Akil	KOS	BRONZE
5	TSOUTLASVILI Michail	GRE	
5	LOMBARDO Manuel	ITA	
7	HOJAK Martin	SLO	
7	BAYAN Hasan	SYR	
9	CULLHAJ Indrit	ALB	
9	ANDREOU Kyprianos	CYP	
9	GIBELLI Enzo	FRA	
9	ABUSHAGUR Abdulati	LBA	
9	DEMIREL Umalt	TUR	

### LEGEND

**DNS** Did not start

**DQB** Disqualified for unsportsmanlike beha **DSQ** Disqualified





## Entry List by Weight Category

Ctry	Name	Date of Birth	Height m / ft	World Rank
ALG - Algeria	BENAZOUG Aghiles-Imad	25 OCT 2001	1.75 / 5' 9"	
BIH - Bosnia and Herzegovina	VUCUREVIC Bozidar	18 JAN 2001	1.83 / 6' 0"	
ESP - Spain	URQUIZA SOLANA Alfonso	14 APR 1994	1.77 / 5' 10"	
FRA - France	GNAMIEN Tizie	26 FEB 2000	1.78 / 5' 10"	
ITA - Italy	BEDEL Kenny Komi	23 DEC 2000		
KOS - Kosovo	KULLASHI Arber	13 MAY 2000	1.76 / 5' 9"	
MAR - Morocco	MOUTII Achraf	4 DEC 1996	1.80 / 5' 11"	
MKD - Rep. of North Macedonia	SHERIFOVSKI Edi	28 AUG 2001	1.81 / 5' 11"	
POR - Portugal	RODRIGUES Manuel	27 AUG 2000	1.85 / 6' 1"	
TUN - Tunisia	HAJJI Wajdi	20 NOV 1999	1.78 / 5' 10"	
TUR - Turkiye	ALBAYRAK Vedat	4 JUN 1993		

TotJudoka: 11

Note:

JUDM81KG-----\_32C 1.0

Report Created MON 27 JUN 2022 18:41

Page 1 / 1

Data Processing and Timing by Microplus - [www.microplustiming.com](http://www.microplustiming.com)



## Draw Sheet

As of THU 30 JUN 2022 at 17:33

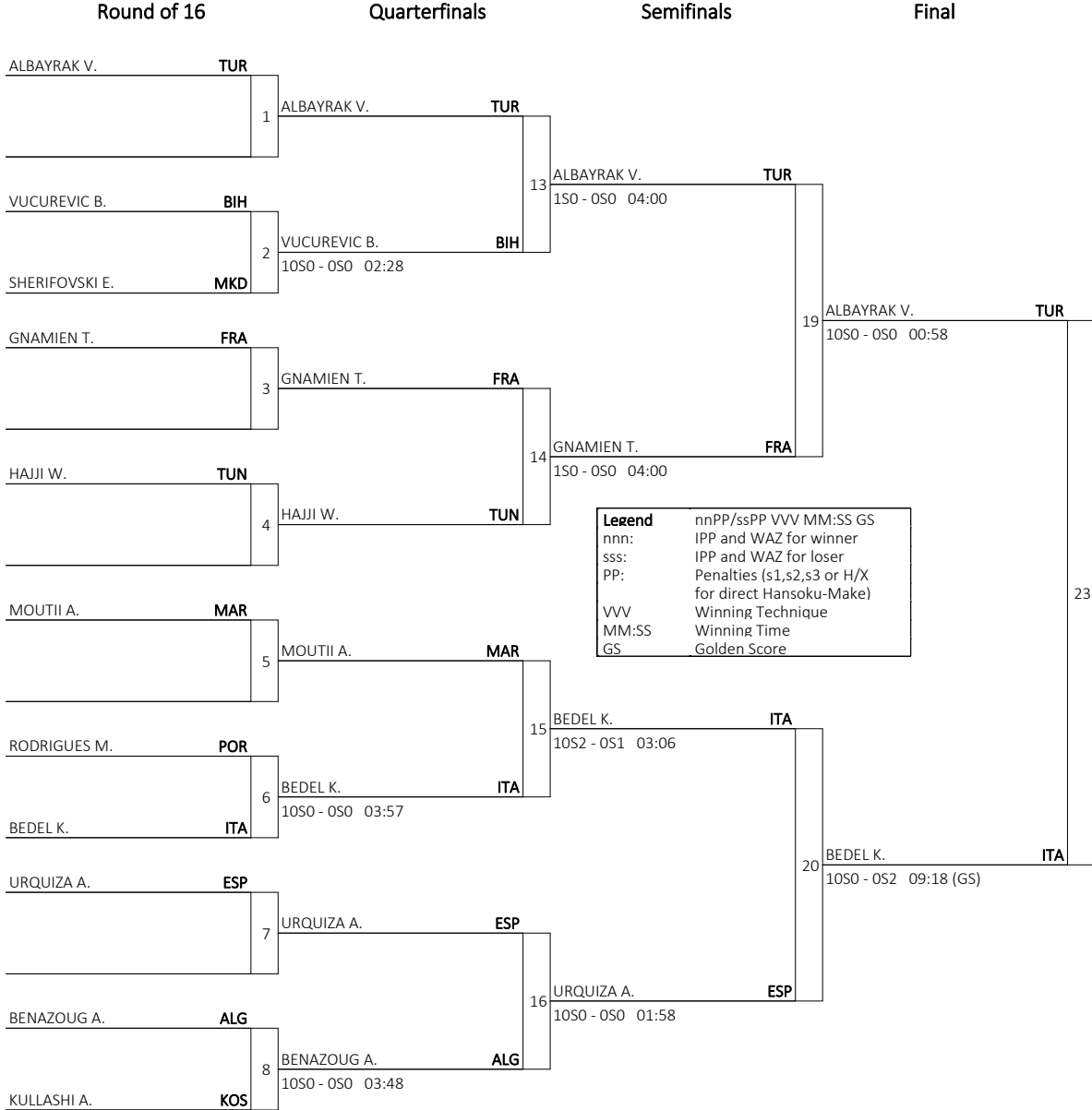

CLASSIFICATION		
1	ALBAYRAK Vedat	TUR
2	BEDEL Kennv Komi	ITA
3	URQUIZA SOLANA Alfonso	ESP
3	GNAMIEN Tizie	FRA
5	VUCUREVIC Bozidar	BIH
5	RODRIGUES Manuel	POR
7	BENAZOUG Aghiles-Imad	ALG
7	MOUTII Achraf	MAR

NumJudoka: 11

Legend	
nnPP/ssPP VVV MM:SS GS	
nnn:	IPP and WAZ for winner
sss:	IPP and WAZ for loser
PP:	Penalties (s1,s2,s3 or H/X for direct Hansoku-Make)
VVV	Winning Technique
MM:SS	Winning Time
GS	Golden Score



## Draw Sheet

Repechage (8)

Repechage

Bronze Contest

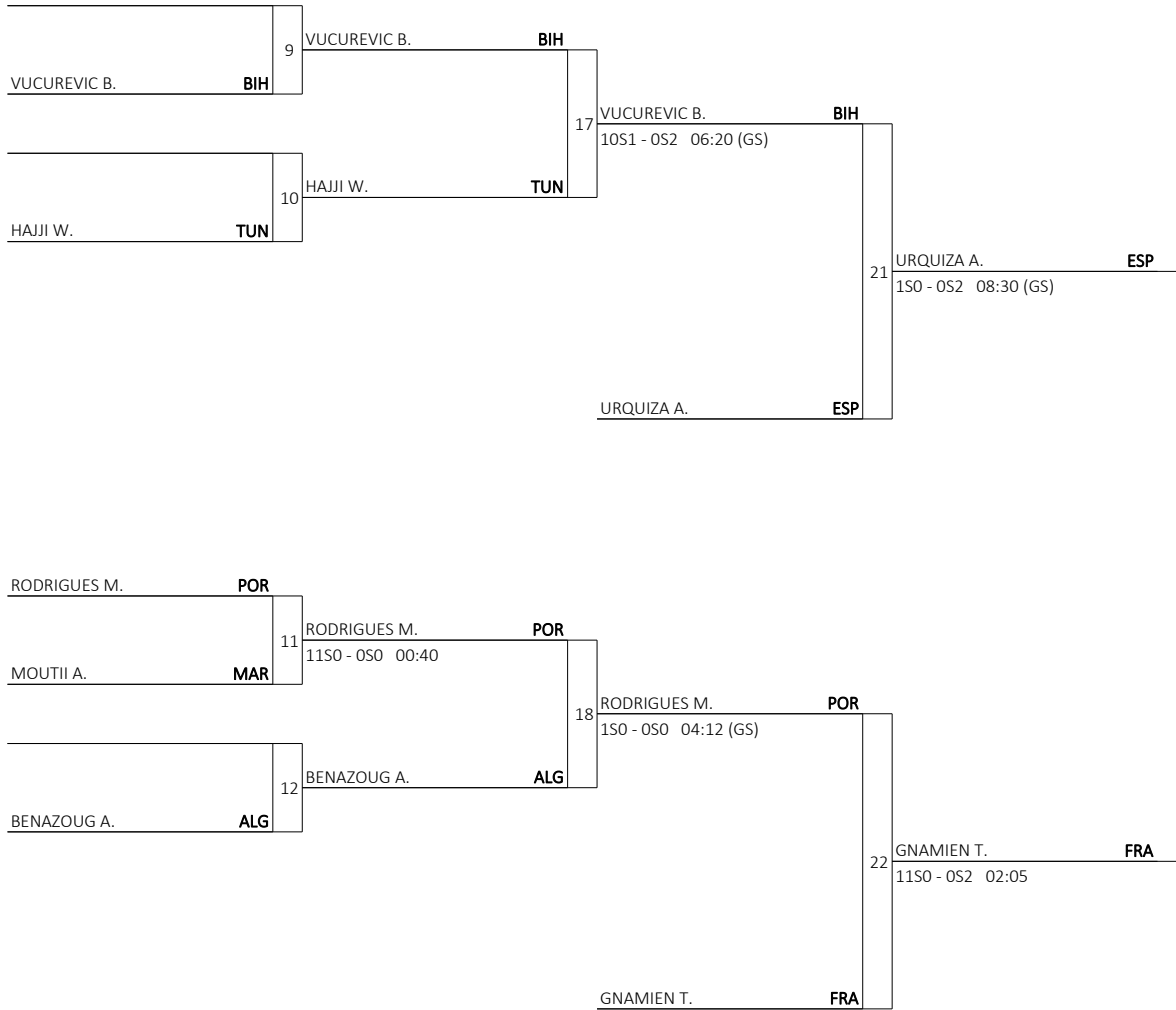



## Results summary

As of THU 30 JUN 2022

Rank	Name	Ctry	Medal
1	ALBAYRAK Vedat	TUR	GOLD
2	BEDEL Kenny Komi	ITA	SILVER
3	URQUIZA SOLANA Alfonso	ESP	BRONZE
3	GNAMIEN Tizie	FRA	BRONZE
5	VUCUREVIC Bozidar	BIH	
5	RODRIGUES Manuel	POR	
7	BENAZOUG Aghiles-Imad	ALG	
7	MOUTII Achraf	MAR	
7	HAJJI Wajdi	TUN	
10	KULLASHI Arber	KOS	
10	SHERIFOVSKI Edi	MKD	

### LEGEND

**DNS** Did not start

**DQB** Disqualified for unsportsmanlike beha **DSQ** Disqualified



## Entry List by Weight Category

Ctry	Name	Date of Birth	Height m / ft	World Rank
ALB - Albania	RAMAJ Erson	21 MAY 1998	1.76 / 5' 9"	
ALG - Algeria	BENAMADI Abderrahmane	3 JUL 1985	1.75 / 5' 9"	
BIH - Bosnia and Herzegovina	MILETIC Toni	12 JAN 1999	1.82 / 6' 0"	
ESP - Spain	MOSAKHLISHVILI Tristani	31 DEC 1997	1.82 / 6' 0"	
FRA - France	DAMIER Francis	24 DEC 2001	1.92 / 6' 4"	
GRE - Greece	TSELIDIS Theodoros	5 AUG 1996	1.81 / 5' 11"	
ITA - Italy	PIRELLI Gennaro	21 AUG 2000	1.80 / 5' 11"	
LBN - Lebanon	SAGAIPOV Caramnob	1 JAN 1997	1.80 / 5' 11"	
MKD - Rep. of North Macedonia	CHAKAROVSKI Andrej	24 DEC 2001	1.84 / 6' 0"	
MON - Monaco	GRINDA Nicolas	19 APR 1997	1.87 / 6' 2"	
SLO - Slovenia	LACKOVIC Narsej	13 JAN 1996	1.84 / 6' 0"	
SRB - Serbia	BRASNJOVIC Darko	20 AUG 1999		
TUN - Tunisia	BEN AMMAR Abdelaziz	6 JUL 1992	1.81 / 5' 11"	
TUR - Turkiye	ZGANK Mihael	1 FEB 1994		

TotJudoka: 14

Note:

JUDM90KG-----\_32C 1.0

Report Created MON 27 JUN 2022 18:41

Page 1 / 1

Data Processing and Timing by Microplus - [www.microplustiming.com](http://www.microplustiming.com)



## Draw Sheet

As of FRI 1 JUL 2022 at 16:18

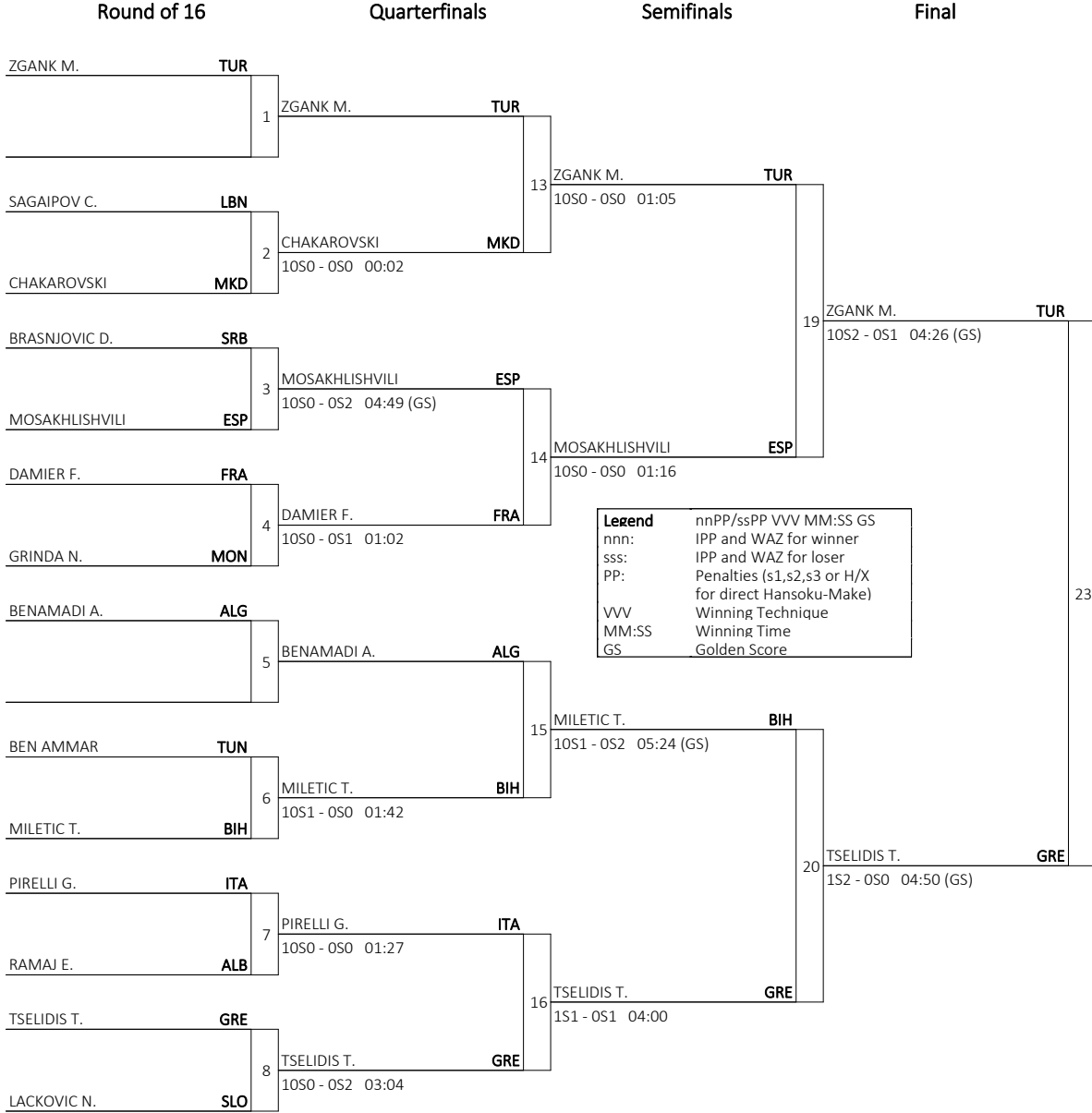

CLASSIFICATION		
1	ZGANK Mihael	TUR
2	TSELIDIS Theodoros	GRE
3	MILETIC Toni	BIH
3	MOSAKHLISHVILI Tristani	ESP
5	BRASNJOVIC Darko	SRB
5	PIRELLI Gennaro	ITA
7	BENAMADI Abderrahmane	ALG
7	DAMIER Francis	FRA

NumJudoka: 14

ZGANK Mihael TUR  
10S1 - 0H 05:35 (GS)



### Draw Sheet

Repechage (8)

Repechage

Bronze Contest

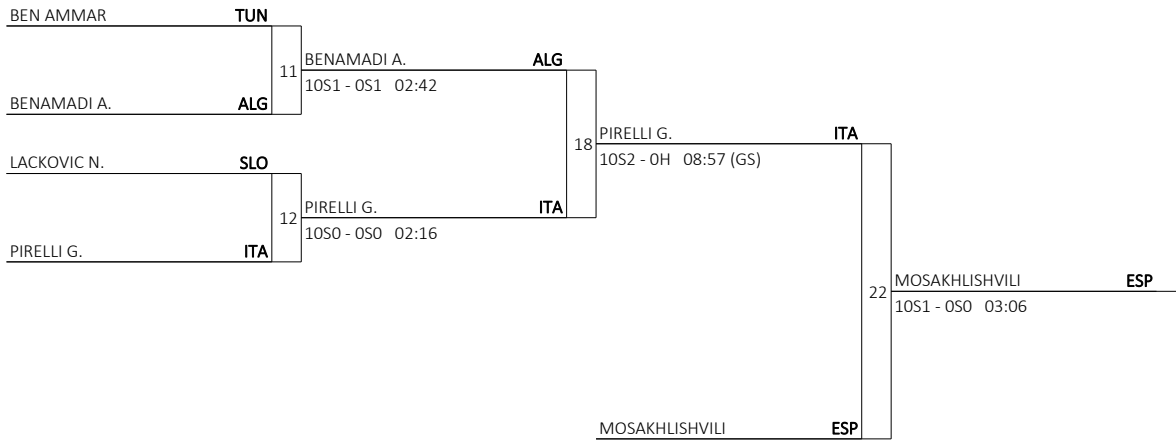
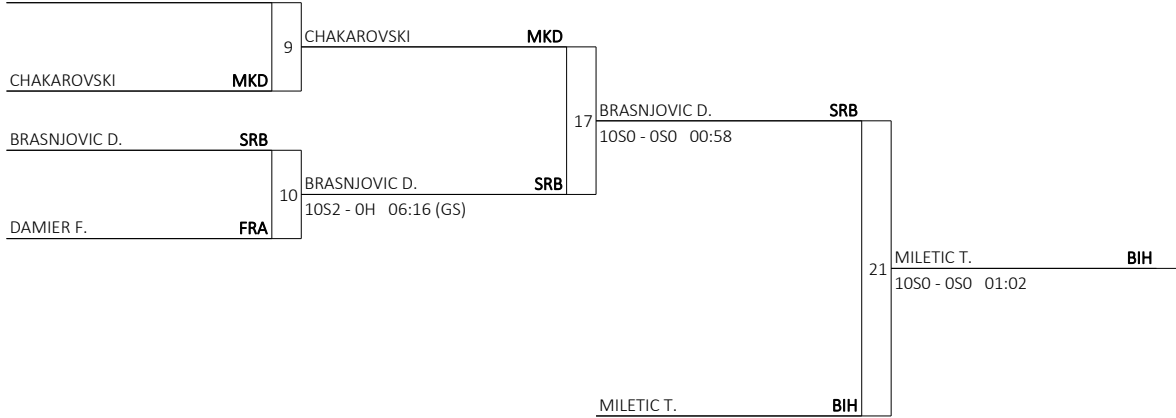



## Results summary

As of FRI 1 JUL 2022

Rank	Name	Ctry	Medal
1	ZGANK Mihael	TUR	GOLD
2	TSELIDIS Theodoros	GRE	SILVER
3	MILETIC Toni	BIH	BRONZE
3	MOSAKHLISHVILI Tristani	ESP	BRONZE
5	BRASNJOVIC Darko	SRB	
5	PIRELLI Gennaro	ITA	
7	BENAMADI Abderrahmane	ALG	
7	DAMIER Francis	FRA	
7	CHAKAROVSKI Andrej	MKD	
10	RAMAJ Erson	ALB	
10	SAGAIPOV Caramnob	LBN	
10	GRINDA Nicolas	MON	
10	LACKOVIC Narsej	SLO	
10	BEN AMMAR Abdelaziz	TUN	

### LEGEND

**DNS** Did not start

**DQB** Disqualified for unsportsmanlike beha **DSQ** Disqualified





## Entry List by Weight Category

Ctry	Name	Date of Birth	Height m / ft	World Rank
ALG - Algeria	BOUAMAR Mustapha Yasser	7 MAR 1998	1.75 / 5' 9"	
CRO - Croatia	KUMRIC Marko	18 MAR 1996	1.92 / 6' 4"	
ESP - Spain	SHERAZADISHVILI Nikoloz	19 FEB 1996	1.92 / 6' 4"	
FRA - France	AGBEGNENOU Joris	27 MAR 2000		
ITA - Italy	BERGAMELLI Enrico	20 APR 2000		
KOS - Kosovo	ZEKAJ Shpati	23 APR 2000	1.93 / 6' 4"	
POR - Portugal	BRITES Diogo Filipe	3 SEP 1998	1.88 / 6' 2"	
SRB - Serbia	KUKOLJ Aleksandar	9 SEP 1991		
TUN - Tunisia	BEN GHARES Koussay	31 MAR 2003	1.86 / 6' 1"	
TUR - Turkiye	SISMANLAR Mert	17 SEP 2000		

TotJudoka: 10

Note:

JUDM100KG-----\_32C 1.0

Report Created MON 27 JUN 2022 18:41

Page 1 / 1

Data Processing and Timing by Microplus - [www.microplustiming.com](http://www.microplustiming.com)



## Draw Sheet

As of FRI 1 JUL 2022 at 17:05

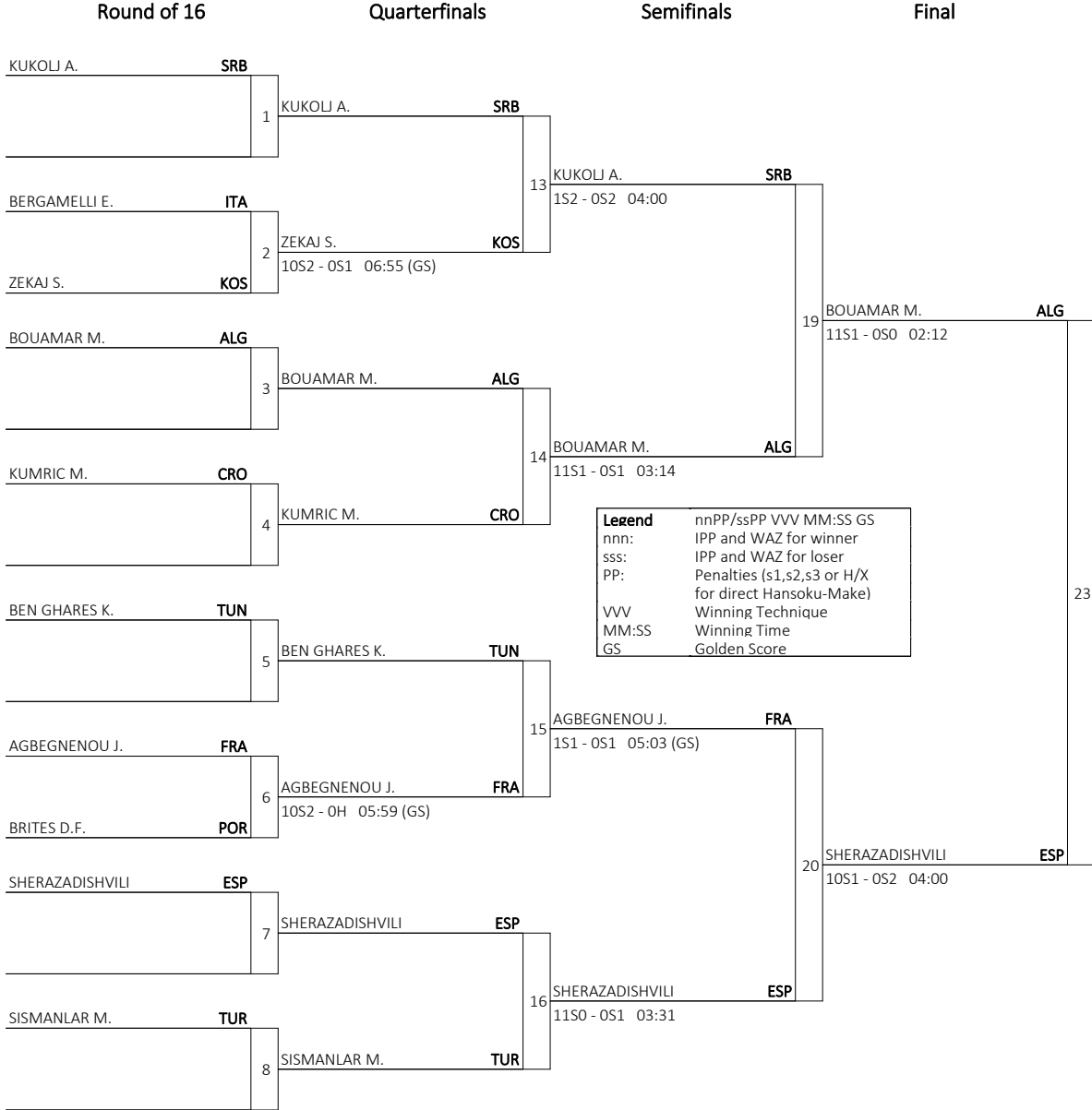

CLASSIFICATION		
1	SHERAZADISHVILI Nikoloz	ESP
2	BOUAMAR Mustapha Yass	ALG
3	AGBEGNENOU Joris	FRA
3	KUKOLJ Aleksandar	SRB
5	KUMRIC Marko	CRO
5	SISMANLAR Mert	TUR
7	ZEKAJ Shpati	KOS
7	BEN GHARES Koussav	TUN

NumJudoka: 10

Legend	
nnPP/ssPP VVV MM:SS GS	
nnn:	IPP and WAZ for winner
sss:	IPP and WAZ for loser
PP:	Penalties (s1,s2,s3 or H/X for direct Hansoku-Make)
VVV	Winning Technique
MM:SS	Winning Time
GS	Golden Score



### Draw Sheet

Repechage (8)

Repechage

Bronze Contest

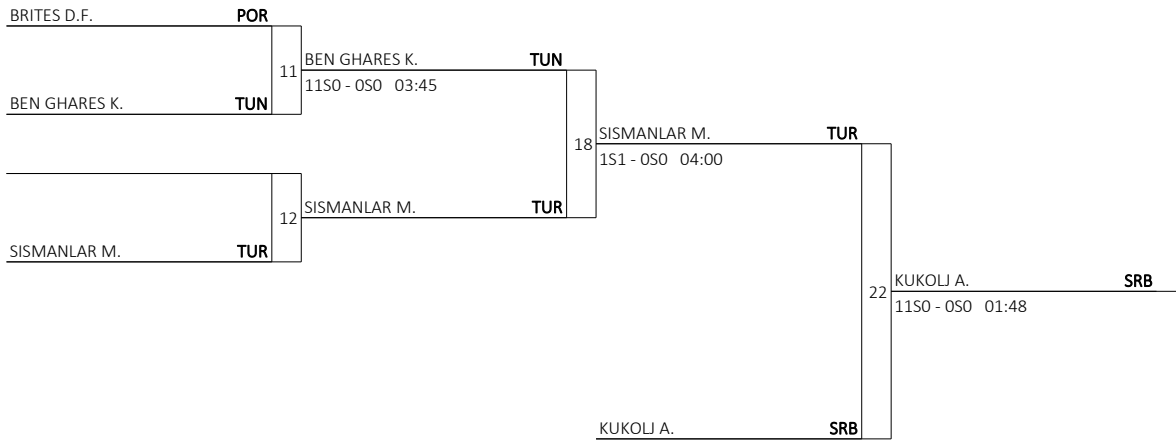
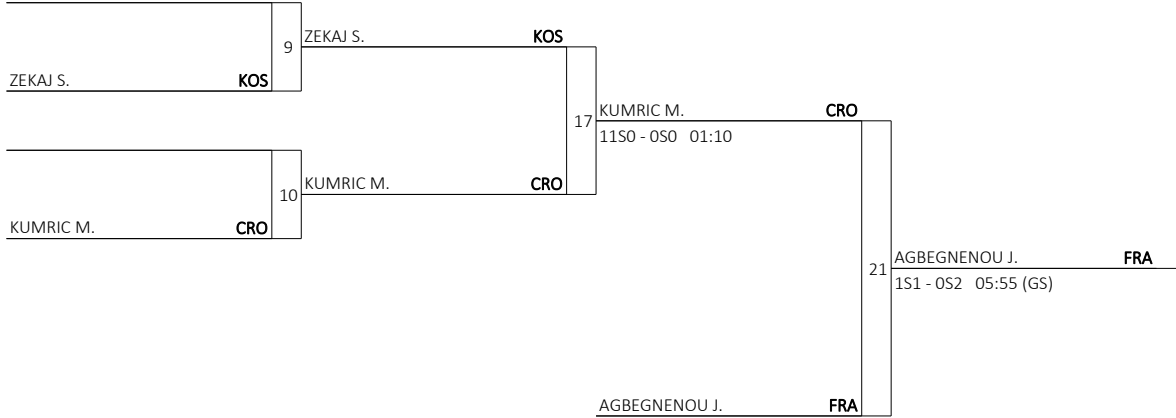



## Results summary

As of FRI 1 JUL 2022

Rank	Name	Ctry	Medal
1	SHERAZADISHVILI Nikoloz	ESP	GOLD
2	BOUAMAR Mustapha Yasser	ALG	SILVER
3	AGBEGNENOU Joris	FRA	BRONZE
3	KUKOLJ Aleksandar	SRB	BRONZE
5	KUMRIC Marko	CRO	
5	SISMANLAR Mert	TUR	
7	ZEKAJ Shpati	KOS	
7	BEN GHARES Koussay	TUN	
9	BERGAMELLI Enrico	ITA	
9	BRITES Diogo Filipe	POR	

### LEGEND

**DNS** Did not start

**DQB** Disqualified for unsportsmanlike beha **DSQ** Disqualified



## Entry List by Weight Category

Ctry	Name	Date of Birth	Height m / ft	World Rank
ALG - Algeria	BELREKAA Mohamed-Sofiane	21 MAR 1991	1.75 / 5' 9"	
BIH - Bosnia and Herzegovina	VUJICIC Vasilije	12 MAY 1999	1.90 / 6' 3"	
CRO - Croatia	SKALEC Marcel	28 JUL 1999	2.00 / 6' 7"	
ESP - Spain	CHELARU GRIGORAS Irinel Vasile	31 MAY 1996	1.60 / 5' 3"	
FRA - France	ANDREEV Guerman	22 SEP 1997	1.85 / 6' 1"	
GRE - Greece	PAPANIKOLAOU Panagiotis	6 JUN 2001	1.90 / 6' 3"	
ITA - Italy	AGRO SYLVAIN Lorenzo	24 JUL 1999		
MAR - Morocco	ESSERYRY Zouhair	10 SEP 2000	1.80 / 5' 11"	
MON - Monaco	GADEAU Marvin	6 SEP 2000	1.86 / 6' 1"	
SLO - Slovenia	DRAGIC Vito	7 JAN 1993	1.98 / 6' 6"	
TUN - Tunisia	HDIOUECH Wahib	9 SEP 2002	1.88 / 6' 2"	
TUR - Turkiye	ERTUG Munir	11 SEP 2003		

TotJudoka: 12

Note:



## Draw Sheet

As of FRI 1 JUL 2022 at 17:52

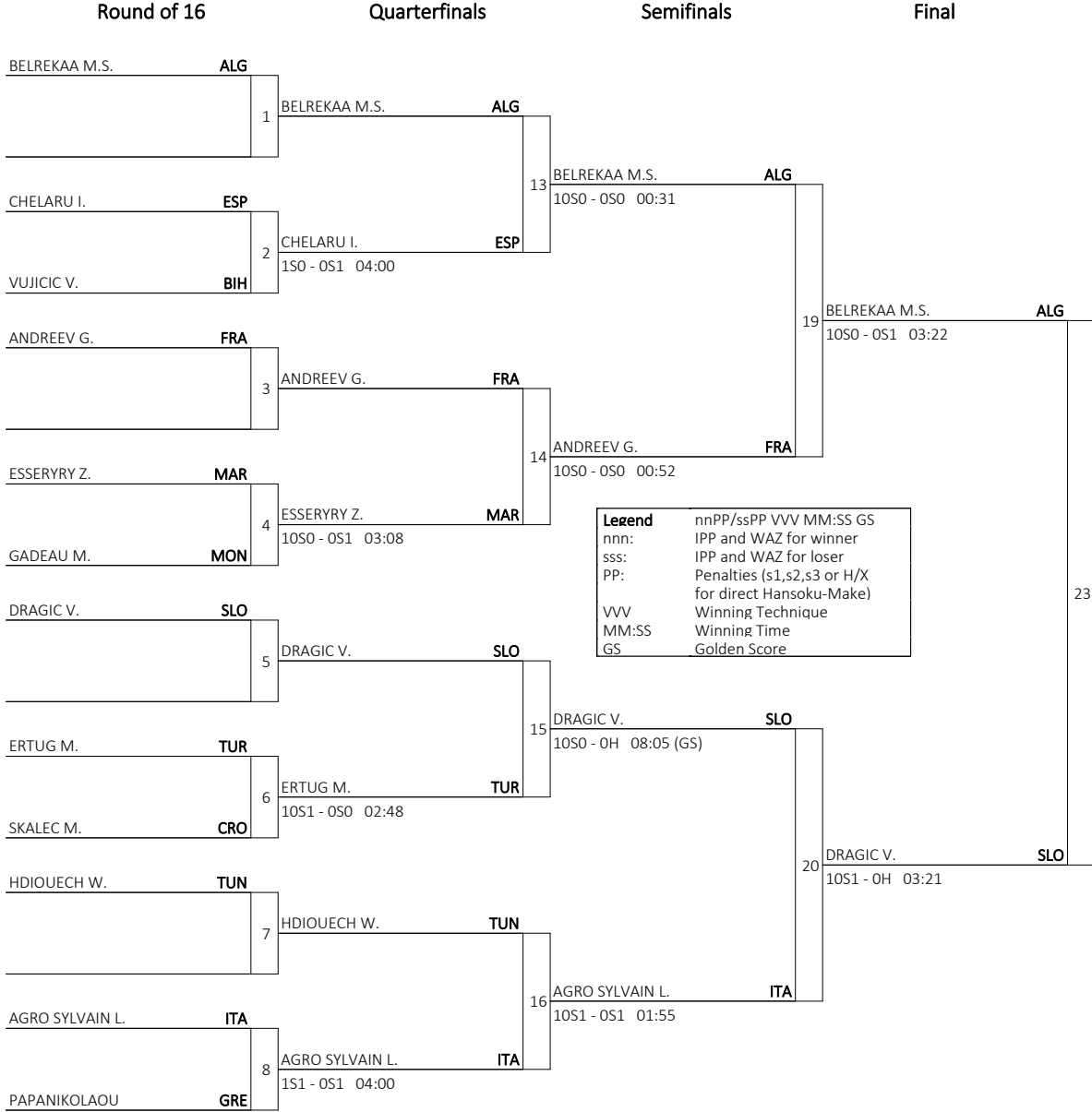

CLASSIFICATION		
1	DRAGIC Vito	SLO
2	BELREKAA Mohamed-Sofia	ALG
3	AGRO SYLVAIN Lorenzo	ITA
3	HDIOUECH Wahib	TUN
5	ESSERYRY Zouhair	MAR
5	ANDREEV Guerman	FRA
7	CHELARU I.	ESP
7	ERTUG Munir	TUR

NumJudoka: 12

Legend	
nnPP/ssPP VVV MM:SS GS	
nnn:	IPP and WAZ for winner
sss:	IPP and WAZ for loser
PP:	Penalties (s1,s2,s3 or H/X for direct Hansoku-Make)
VVV	Winning Technique
MM:SS	Winning Time
GS	Golden Score

DRAGIC Vito SLO  
1S0 - 0S1 04:00



### Draw Sheet

Repechage (8)

Repechage

Bronze Contest

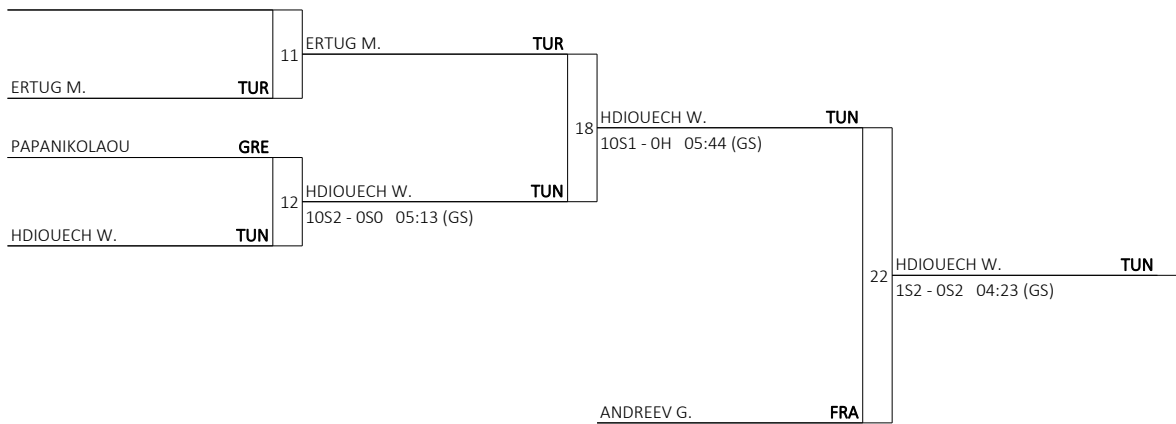
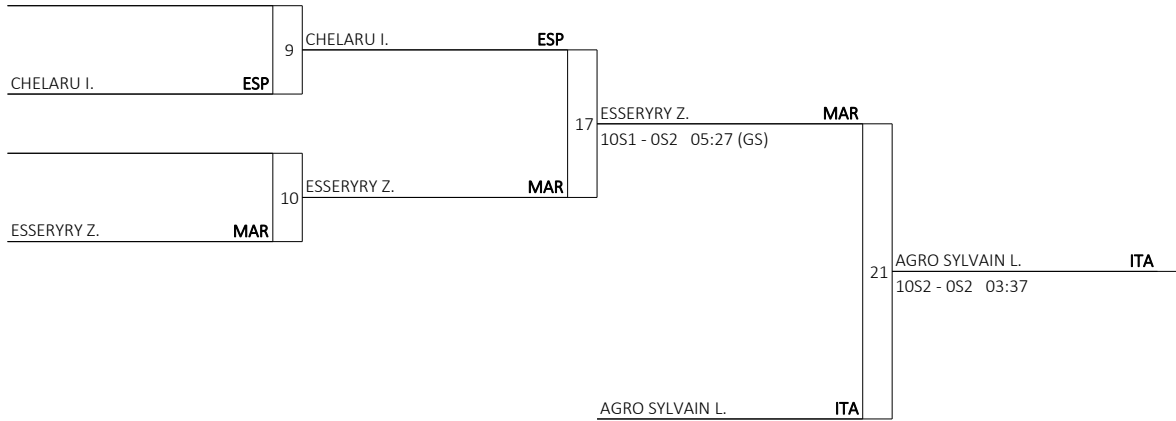



## Results summary

As of FRI 1 JUL 2022

Rank	Name	Ctry	Medal
1	DRAGIC Vito	SLO	GOLD
2	BELREKAA Mohamed-Sofiane	ALG	SILVER
3	AGRO SYLVAIN Lorenzo	ITA	BRONZE
3	HDIOUECH Wahib	TUN	BRONZE
5	ESSERYRY Zouhair	MAR	
5	ANDREEV Guerman	FRA	
7	CHELARU GRIGORAS Irinel Vasile	ESP	
7	ERTUG Munir	TUR	
9	VUJICIC Vasilije	BIH	
9	SKALEC Marcel	CRO	
9	PAPANIKOLAOU Panagiotis	GRE	
9	GADEAU Marvin	MON	

### LEGEND

**DNS** Did not start

**DQB** Disqualified for unsportsmanlike beha **DSQ** Disqualified





## Entry List by Weight Category

Ctry	Name	Date of Birth	Height m / ft	World Rank
ALG - Algeria	REZZOUG Imene	12 SEP 1993	1.65 / 5' 5"	
ESP - Spain	LAPUERTA I COMAS Mireia	28 MAY 1999	1.62 / 5' 4"	
FRA - France	VIEU Melanie	16 DEC 1998	1.59 / 5' 3"	
ITA - Italy	PETITTO Sofia	17 JUN 1998		
KOS - Kosovo	MUMINOVIQ Erza	3 MAY 2002	1.55 / 5' 1"	
MAR - Morocco	EDDINARI Chaimae	19 JUL 1999	1.60 / 5' 3"	
POR - Portugal	BRITO Raquel Nunes	7 JUN 2002	1.70 / 5' 7"	
SLO - Slovenia	STANGAR Marusa	31 JAN 1998	1.59 / 5' 3"	
SRB - Serbia	NIKOLIC Milica	7 NOV 1994		
TUN - Tunisia	BEDIOUI Oumaima	27 JAN 1998	1.55 / 5' 1"	
TUR - Turkiye	SENTURK Gul Kader	8 JAN 1996		

TotJudoka: 11

Note:

JUDW48KG-----\_32C 1.0

Report Created MON 27 JUN 2022 18:36

Page 1 / 1

Data Processing and Timing by Microplus - [www.microplustiming.com](http://www.microplustiming.com)



## Draw Sheet

As of WED 29 JUN 2022 at 16:32

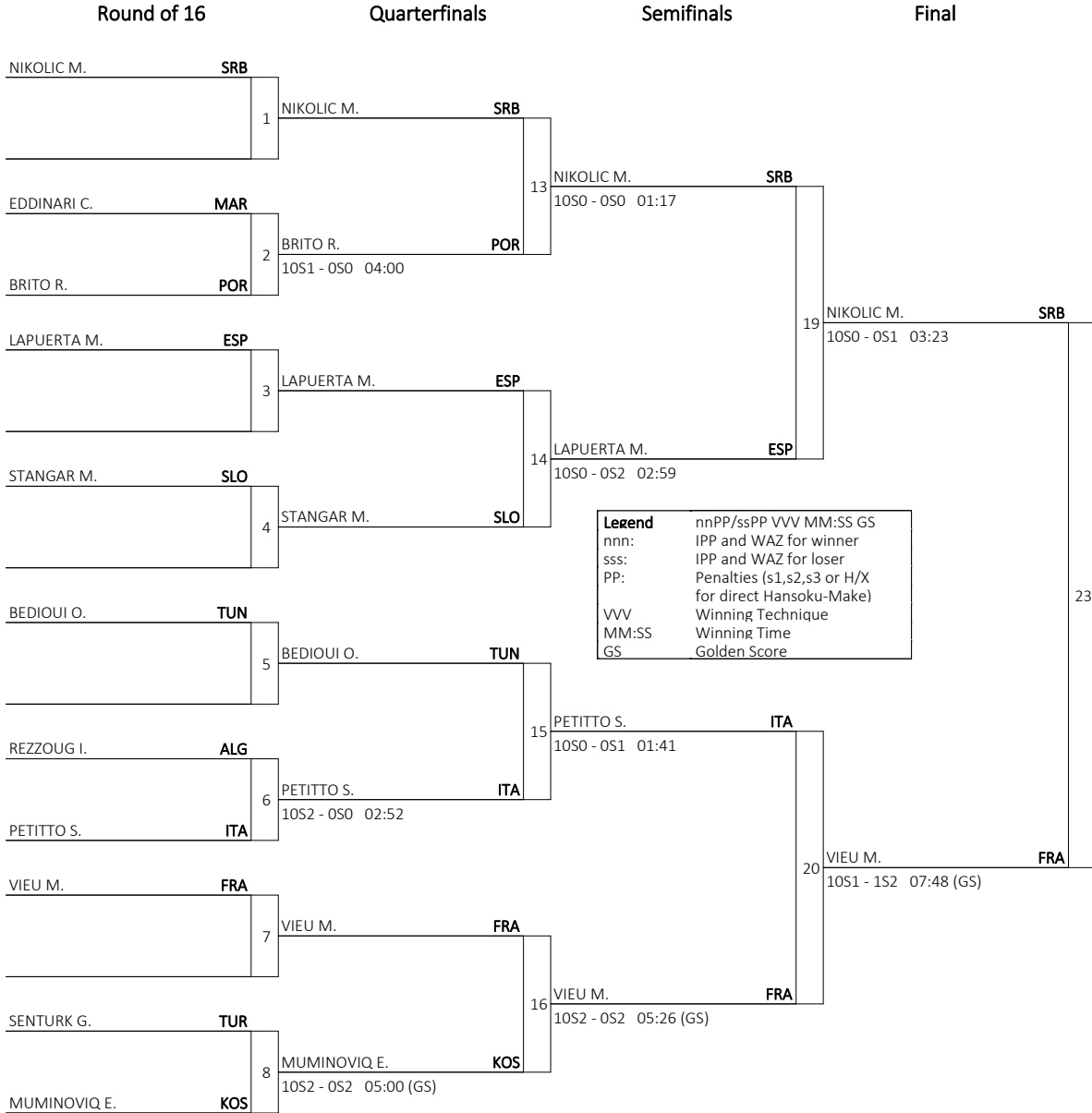

CLASSIFICATION		
1	VIEU Melanie	FRA
2	NIKOLIC Milica	SRB
3	STANGAR Marusa	SLO
3	BEDIOUI Oumaima	TUN
5	PETITTO Sofia	ITA
5	LAPUERTA I COMAS Mireia	ESP
7	MUMINOVIQ Erza	KOS
7	BRITO Raquel Nunes	POR

NumJudoka: 11

VIEU Melanie FRA  
1S2 - OSO 06:00 (GS)



## Draw Sheet

Repechage (8)

Repechage

Bronze Contest

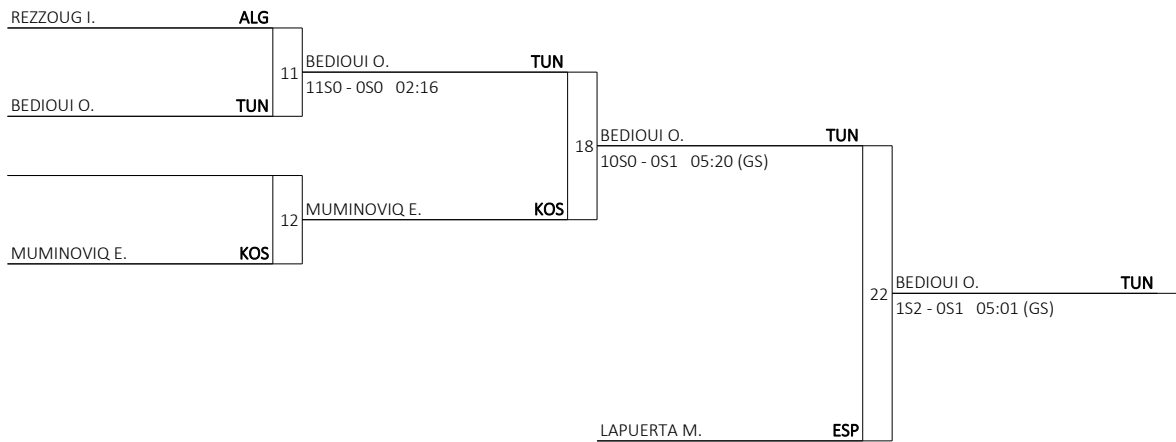
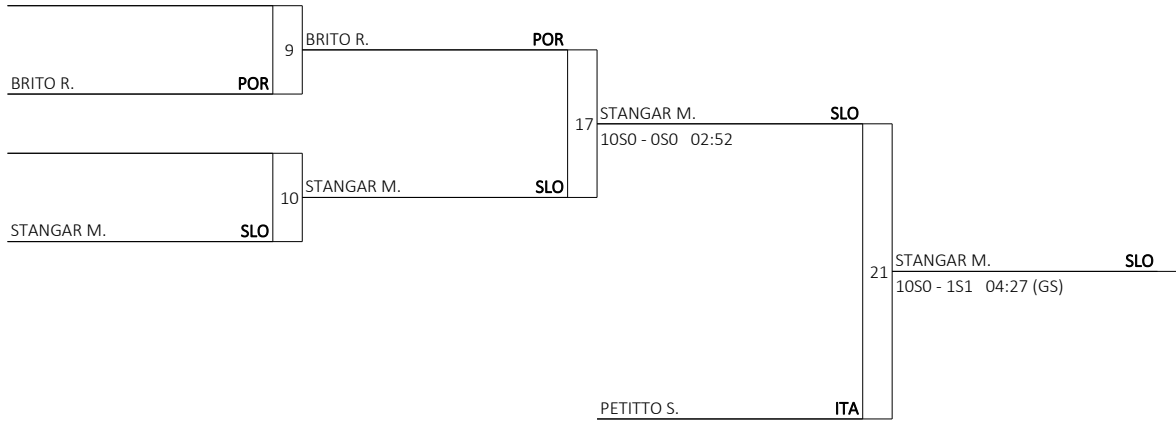



## Results summary

As of WED 29 JUN 2022

Rank	Name	Ctry	Medal
1	VIEU Melanie	FRA	GOLD
2	NIKOLIC Milica	SRB	SILVER
3	STANGAR Marusa	SLO	BRONZE
3	BEDIOUI Oumaima	TUN	BRONZE
5	PETITTO Sofia	ITA	
5	LAPUERTA I COMAS Mireia	ESP	
7	MUMINOVIQ Erza	KOS	
7	BRITO Raquel Nunes	POR	
9	REZZOUG Imene	ALG	
9	EDDINARI Chaimae	MAR	
9	SENTURK Gul Kader	TUR	

### LEGEND

**DNS** Did not start

**DQB** Disqualified for unsportsmanlike beha **DSQ** Disqualified



## Entry List by Weight Category

Ctry	Name	Date of Birth	Height m / ft	World Rank
ALG - Algeria	AISSAHINE Faiza	20 JUL 1993	1.75 / 5' 9"	
CRO - Croatia	PULJIZ Ana Viktorija	1 JAN 2002	1.61 / 5' 3"	
CYP - Cyprus	ASVESTA Sofia	5 JUN 2000	1.52 / 5' 0"	
ESP - Spain	PEREZ BOX Ana Isabel	29 DEC 1995	1.60 / 5' 3"	
FRA - France	DEVICTOR Chloe	8 SEP 2002	1.59 / 5' 3"	
ITA - Italy	GIORDA Francesca	30 MAR 1996		
KOS - Kosovo	KRASNIQI Distria	10 DEC 1995	1.55 / 5' 1"	
MAR - Morocco	IRAOUI Soumiya	19 MAR 1996	1.60 / 5' 3"	
SLO - Slovenia	STANGAR Anja	6 JAN 1996	1.63 / 5' 4"	
SRB - Serbia	PETROVIC Nadezda	11 DEC 1999		
TUR - Turkiye	KARABULUT Buketnur	1 MAY 2003		

TotJudoka: 11

Note:

JUDW52KG-----\_32C 1.0

Report Created MON 27 JUN 2022 18:38

Page 1 / 1

Data Processing and Timing by Microplus - [www.microplustiming.com](http://www.microplustiming.com)



## Draw Sheet

As of WED 29 JUN 2022 at 17:07

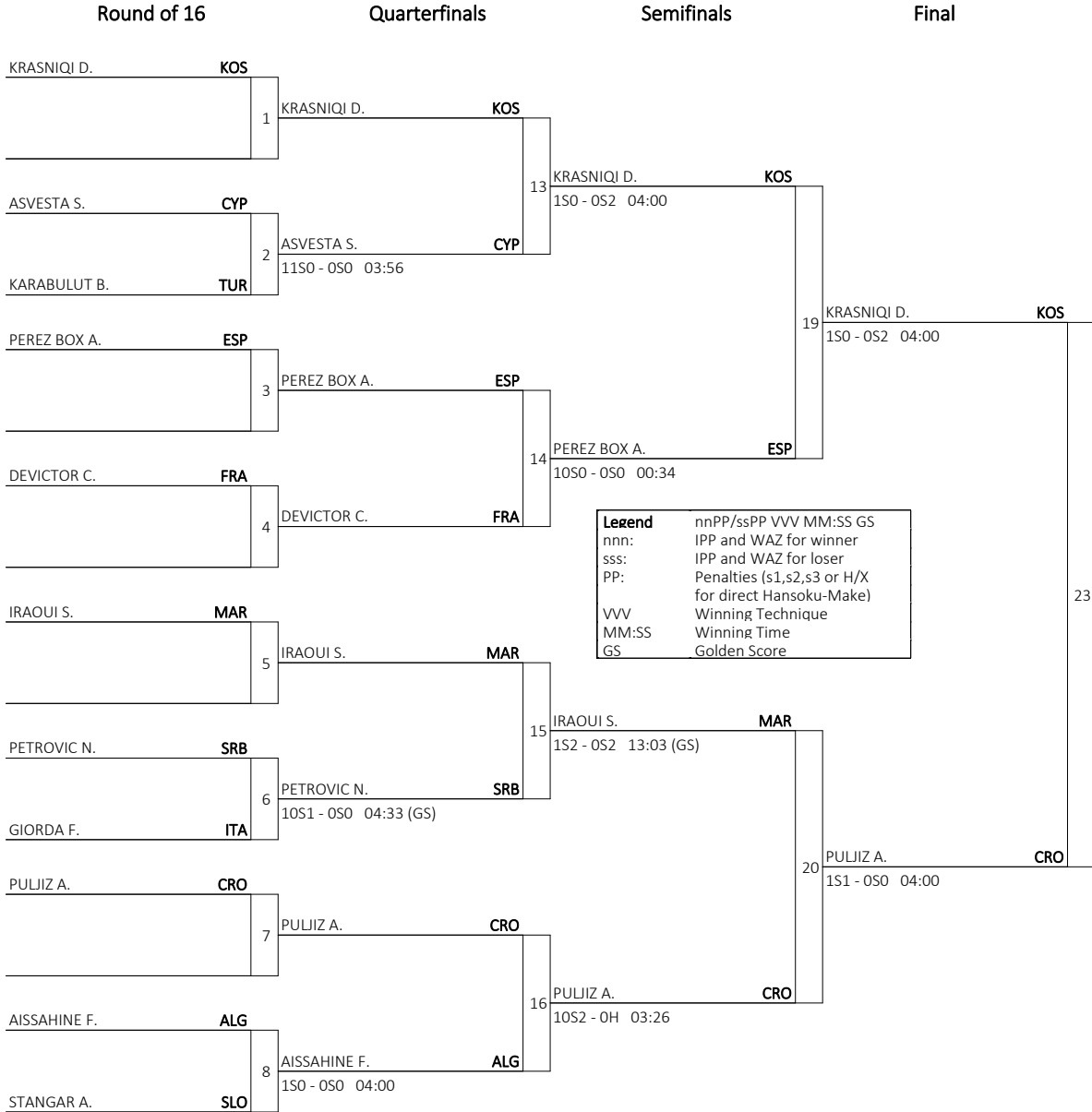

**Legend**

- nnPP/ssPP VVV MM:SS GS
- nnn: IPP and WAZ for winner
- sss: IPP and WAZ for loser
- PP: Penalties (s1,s2,s3 or H/X for direct Hansoku-Make)
- VVV Winning Technique
- MM:SS Winning Time
- GS Golden Score

CLASSIFICATION		
1	KRASNIQI Distria	KOS
2	PULJIZ Ana Viktoriia	CRO
3	DEVICTOR Chloe	FRA
3	PEREZ BOX Ana Isabel	ESP
5	IRAQUI Soumiya	MAR
5	AISSAHINE Faiza	ALG
7	ASVESTA Sofia	CYP
7	PETROVIC Nadezda	SRB

NumJudoka: 11



### Draw Sheet

Repechage (8)

Repechage

Bronze Contest

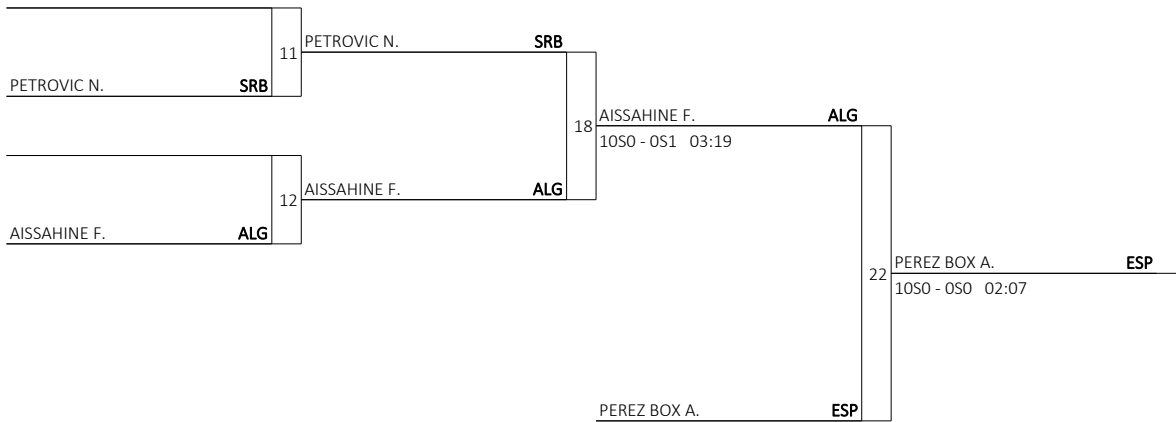
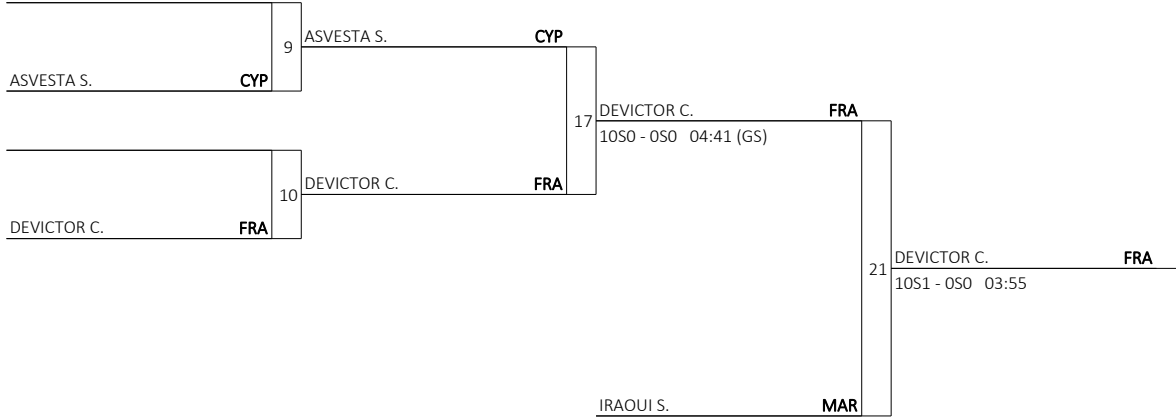



## Results summary

As of WED 29 JUN 2022

Rank	Name	Ctry	Medal
1	KRASNIQI Distria	KOS	GOLD
2	PULJIZ Ana Viktorija	CRO	SILVER
3	DEVICTOR Chloe	FRA	BRONZE
3	PEREZ BOX Ana Isabel	ESP	BRONZE
5	IRAQUI Soumiya	MAR	
5	AISSAHINE Faiza	ALG	
7	ASVESTA Sofia	CYP	
7	PETROVIC Nadezda	SRB	
9	GIORDA Francesca	ITA	
9	STANGAR Anja	SLO	
9	KARABULUT Buketnur	TUR	

### LEGEND

**DNS** Did not start

**DQB** Disqualified for unsportsmanlike beha **DSQ** Disqualified





## Entry List by Weight Category

Ctry	Name	Date of Birth	Height m / ft	World Rank
ALG - Algeria	HALATA Yamina	4 SEP 1991	1.75 / 5' 9"	
BIH - Bosnia and Herzegovina	SAMARDZIC Andela	20 JUL 2000	1.65 / 5' 5"	
ESP - Spain	RUIZ MURO Maria	3 FEB 1996	1.62 / 5' 4"	
FRA - France	VELLOZZI Ophelie	1 FEB 2000	1.65 / 5' 5"	
ITA - Italy	CAGGIANO Giulia	7 NOV 1995		
KOS - Kosovo	LOXHA Flaka	5 APR 1999	1.65 / 5' 5"	
POR - Portugal	SANTOS Teresa	23 MAR 2002	1.64 / 5' 5"	
SRB - Serbia	PERISIC Marica	25 JAN 2000		
TUR - Turkiye	BOZKURT Hasret	7 MAR 2001		

TotJudoka: 9

Note:



## Draw Sheet

As of WED 29 JUN 2022 at 18:04

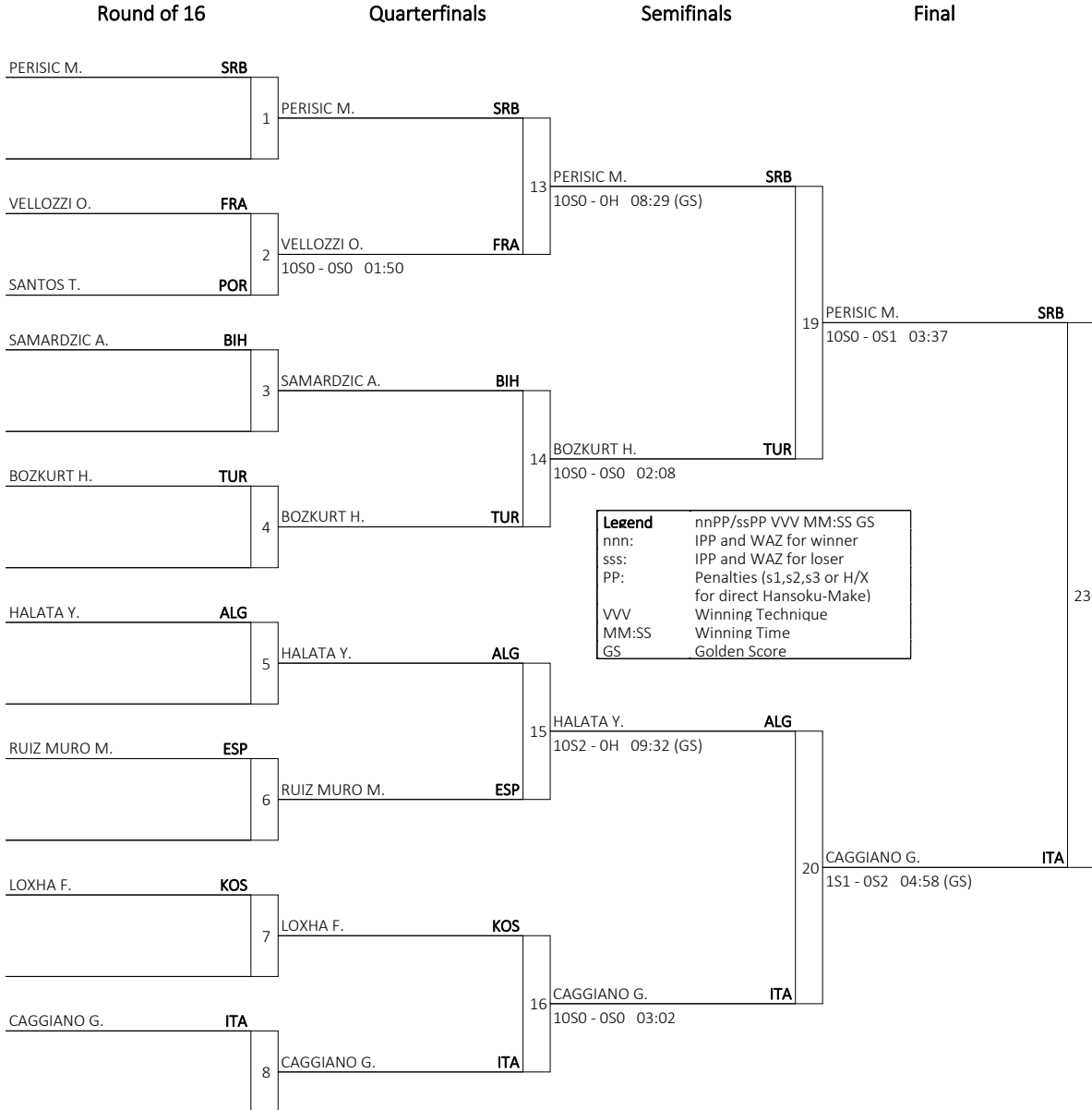

CLASSIFICATION		
1	PERISIC Marica	SRB
2	CAGGIANO Giulia	ITA
3	SAMARDZIC Andela	BIH
3	LOXHA Flaka	KOS
5	HALATA Yamina	ALG
5	BOZKURT Hasret	TUR
7	RUIZ MURO Maria	ESP
7	VELLOZZI Ophelie	FRA

NumJudoka: 9

**PERISIC Marica SRB**  
10S2 - 0X 09:23 (GS)



### Draw Sheet

Repechage (8)

Repechage

Bronze Contest

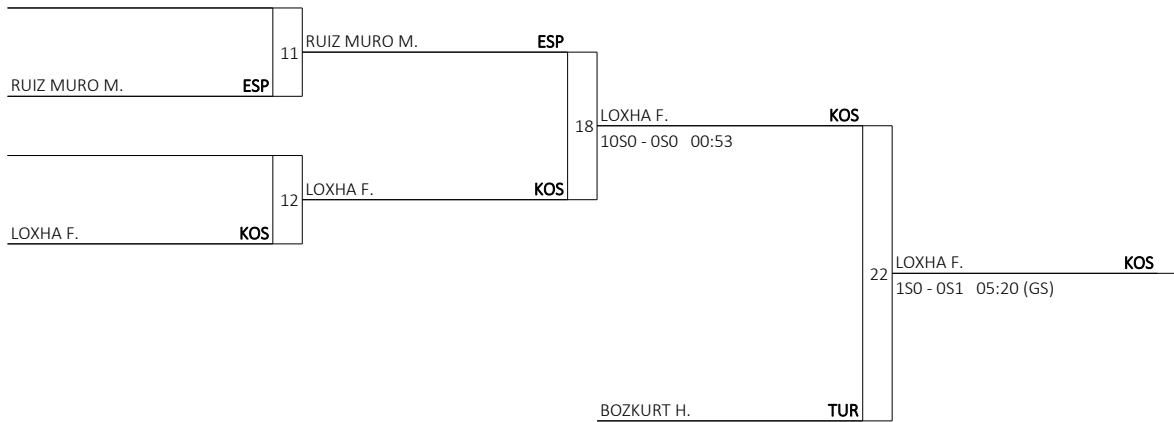
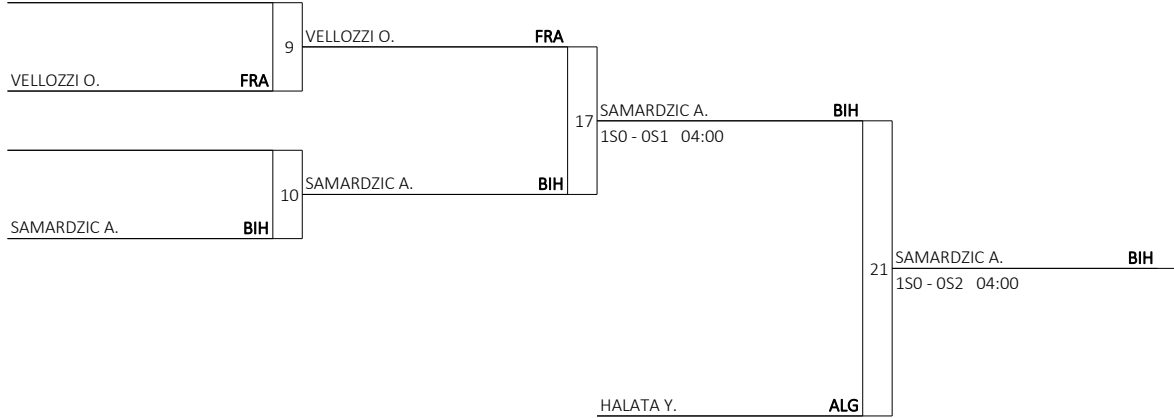



## Results summary

As of WED 29 JUN 2022

Rank	Name	Ctry	Medal
1	PERISIC Marica	SRB	GOLD
2	CAGGIANO Giulia	ITA	SILVER
3	SAMARDZIC Andela	BIH	BRONZE
3	LOXHA Flaka	KOS	BRONZE
5	HALATA Yamina	ALG	
5	BOZKURT Hasret	TUR	
7	RUIZ MURO Maria	ESP	
7	VELLOZZI Ophelie	FRA	
9	SANTOS Teresa	POR	

### LEGEND

**DNS** Did not start

**DQB** Disqualified for unsportsmanlike beha **DSQ** Disqualified



## Entry List by Weight Category

Ctry	Name	Date of Birth	Height m / ft	World Rank
ALG - Algeria	BELKADI Amina	10 NOV 1992	1.75 / 5' 9"	
CRO - Croatia	OBERAN Iva	17 NOV 1999	1.73 / 5' 8"	
ESP - Spain	CABANA PEREZ Cristina	6 MAY 1993	1.65 / 5' 5"	
FRA - France	TURPIN Melodie	27 APR 2001	1.65 / 5' 5"	
ITA - Italy	D'ISANTO Nicolle	22 JAN 1999		
KOS - Kosovo	FAZLIU Laura	28 SEP 2000	1.73 / 5' 8"	
MAR - Morocco	HARACHI Sarah	17 JAN 1996	1.65 / 5' 5"	
POR - Portugal	GOMES Wilsa	25 OCT 1997	1.64 / 5' 5"	
TUN - Tunisia	BJAOUI Mariem	29 OCT 1996	1.72 / 5' 8"	
TUR - Turkiye	YEKSAN Ayten Mediha	17 MAR 2002		

TotJudoka: 10

Note:

JUDW63KG-----\_32C 1.0

Report Created MON 27 JUN 2022 18:39

Page 1 / 1

Data Processing and Timing by Microplus - [www.microplustiming.com](http://www.microplustiming.com)



## Draw Sheet

As of THU 30 JUN 2022 at 16:28

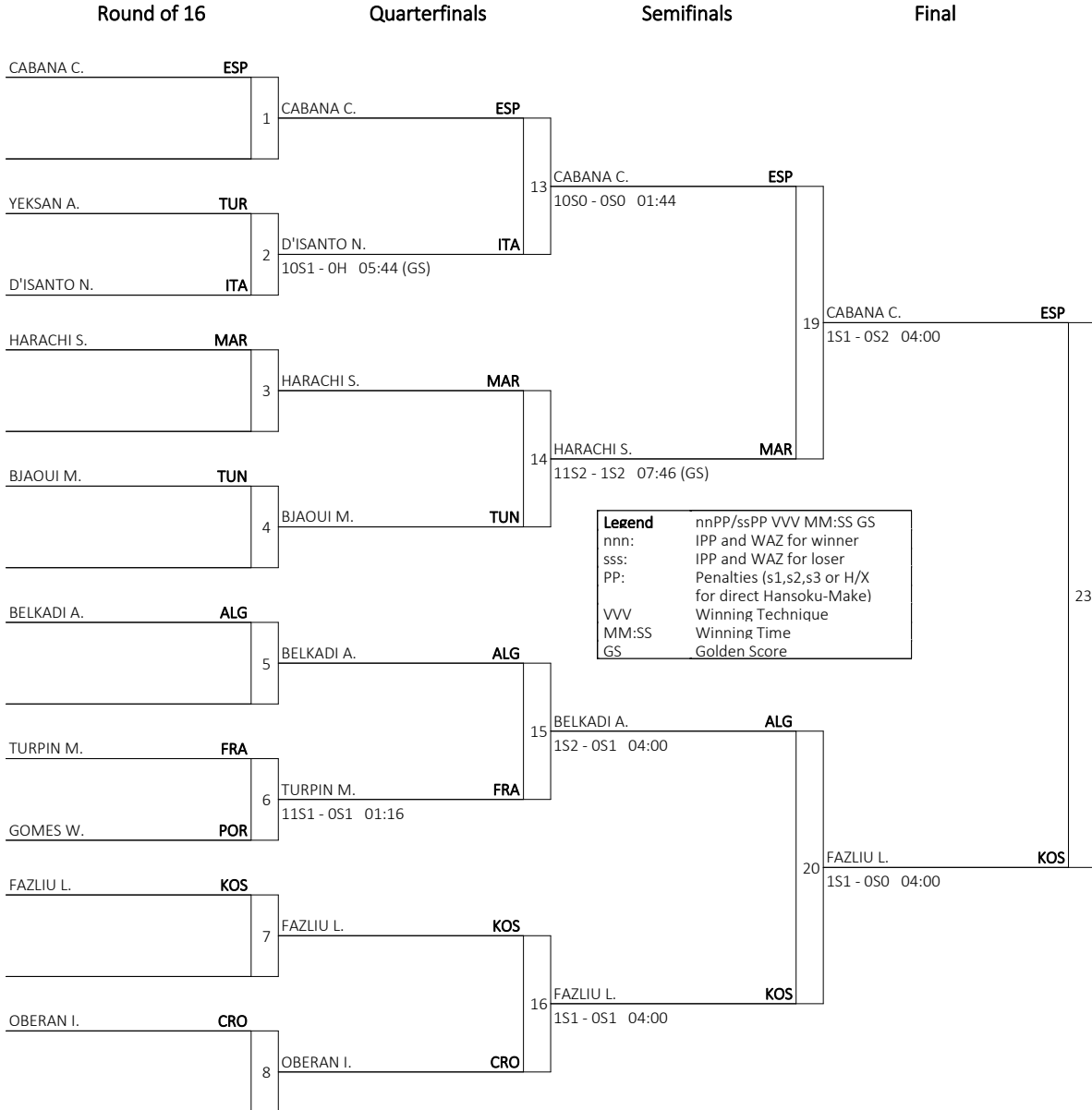

CLASSIFICATION		
1	FAZLIU Laura	KOS
2	CABANA PEREZ Cristina	ESP
3	BELKADI Amina	ALG
3	OBERAN Iva	CRO
5	D'ISANTO Nicolle	ITA
5	HARACHI Sarah	MAR
7	TURPIN Melodie	FRA
7	BJAOUI Mariem	TUN

NumJudoka: 10

Legend	
nnPP/ssPP VVV MM:SS GS	
nnn:	IPP and WAZ for winner
sss:	IPP and WAZ for loser
PP:	Penalties (s1,s2,s3 or H/X for direct Hansoku-Make)
VVV	Winning Technique
MM:SS	Winning Time
GS	Golden Score

FAZLIU Laura KOS  
1S0 - 0S0 05:17 (GS)



### Draw Sheet

Repechage (8)

Repechage

Bronze Contest

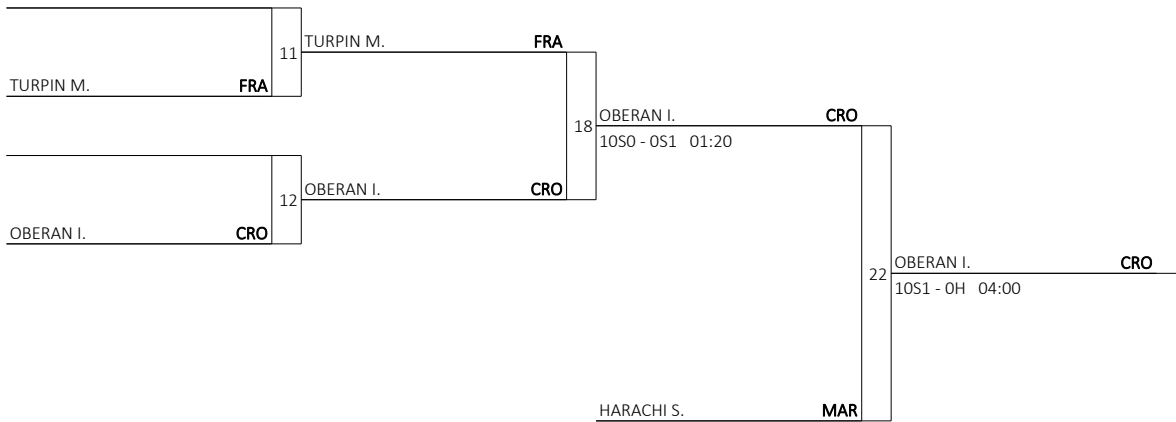
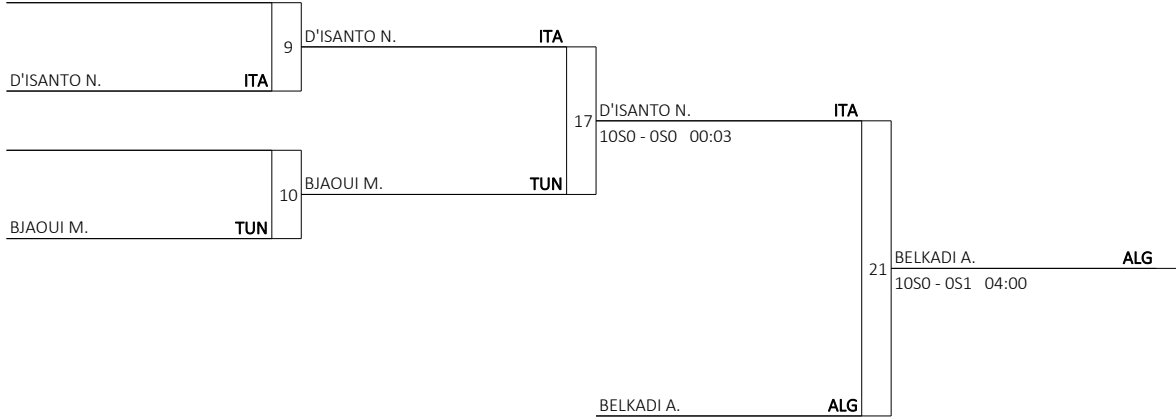



## Results summary

As of THU 30 JUN 2022

Rank	Name	Ctry	Medal
1	FAZLIU Laura	KOS	GOLD
2	CABANA PEREZ Cristina	ESP	SILVER
3	BELKADI Amina	ALG	BRONZE
3	OBERAN Iva	CRO	BRONZE
5	D'ISANTO Nicolle	ITA	
5	HARACHI Sarah	MAR	
7	TURPIN Melodie	FRA	
7	BJAOUI Mariem	TUN	
9	GOMES Wilsa	POR	
9	YEKSAN Ayten Mediha	TUR	

### LEGEND

**DNS** Did not start

**DQB** Disqualified for unsportsmanlike beha **DSQ** Disqualified





## Entry List by Weight Category

Ctry	Name	Date of Birth	Height m / ft	World Rank
ALG - Algeria	BELLAKEHAL Souad	23 MAR 1992	1.75 / 5' 9"	
BIH - Bosnia and Herzegovina	SAMARDZIC Aleksandra	23 SEP 1997	1.80 / 5' 11"	
CRO - Croatia	CVJETKO Lara	1 SEP 2001	1.73 / 5' 8"	
ESP - Spain	TSUNODA ROUSTANT Ai	19 APR 2002	1.63 / 5' 4"	
FRA - France	ISSOUFI Kaila	28 MAR 2001	1.68 / 5' 6"	
GRE - Greece	TELTSIDOU Elisavet	8 NOV 1995	1.70 / 5' 7"	
ITA - Italy	ESPOSITO Martina	6 DEC 2001		
POR - Portugal	CRISOSTOMO Joana Cristina	31 OCT 2001	1.72 / 5' 8"	
SLO - Slovenia	POGACNIK Anka	23 DEC 1991	1.70 / 5' 7"	
TUN - Tunisia	LANDOLSI Nihel	1 JUL 1995	1.81 / 5' 11"	
TUR - Turkiye	AKDENIZ Minel	30 JUN 1999		

TotJudoka: 11

Note:

JUDW70KG-----\_32C 1.0

Report Created MON 27 JUN 2022 18:39

Page 1 / 1

Data Processing and Timing by Microplus - [www.microplustiming.com](http://www.microplustiming.com)



## Draw Sheet

As of THU 30 JUN 2022 at 15:26

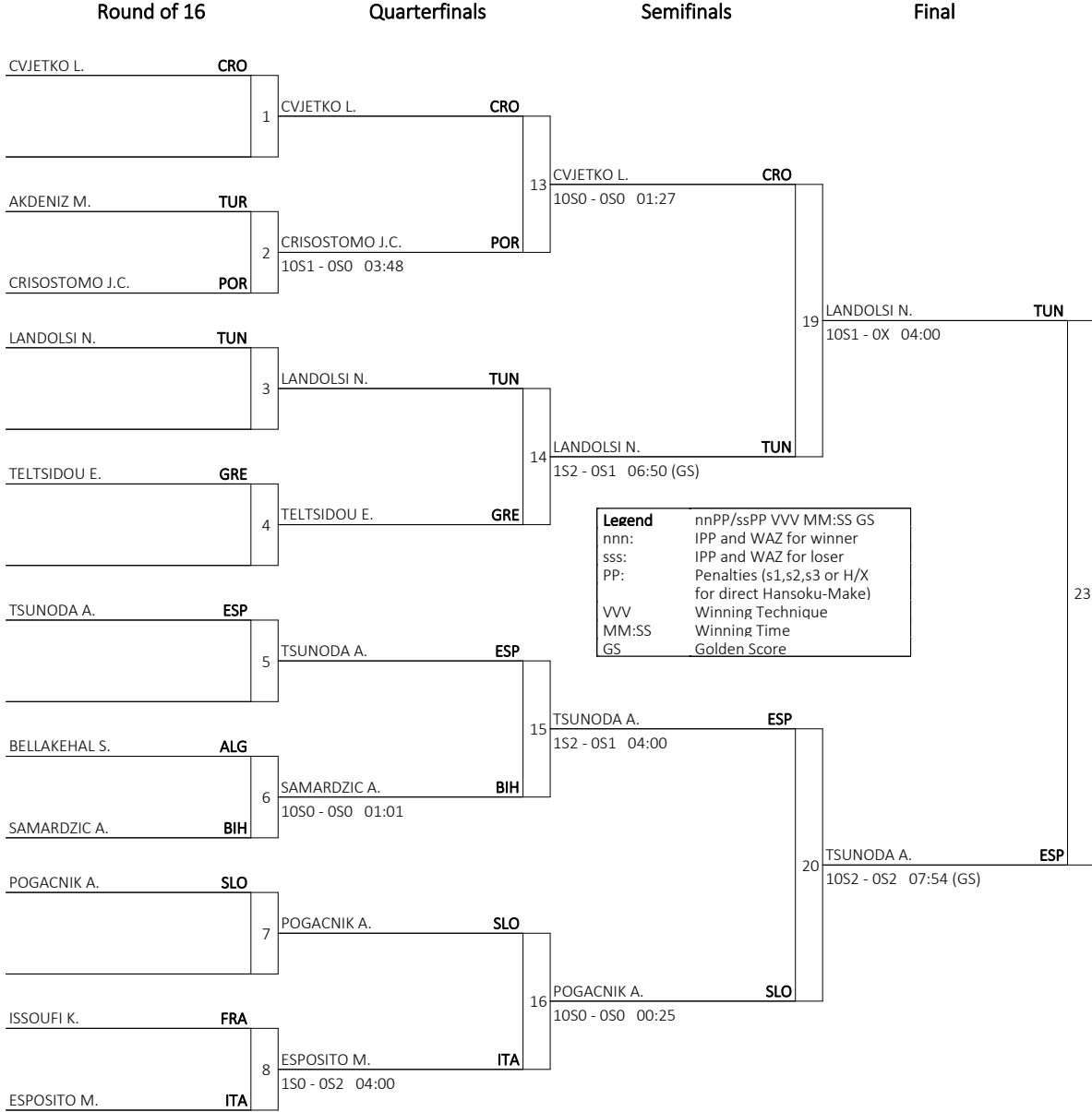

CLASSIFICATION		
7	SAMARDZIC Aleksandra	BIH
7	CRISOSTOMO J.C.	POR
9	BELLAKEHAL Souad	ALG
9	ISSOUFI Kaila	FRA
9	AKDENIZ Mineel	TUR

NumJudoka: 11



## Draw Sheet

Repechage (8)

Repechage

Bronze Contest

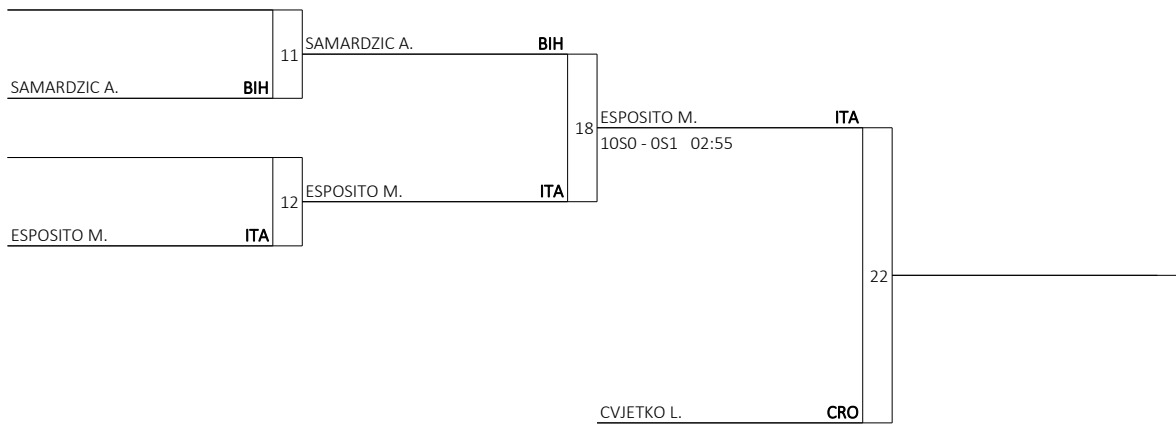
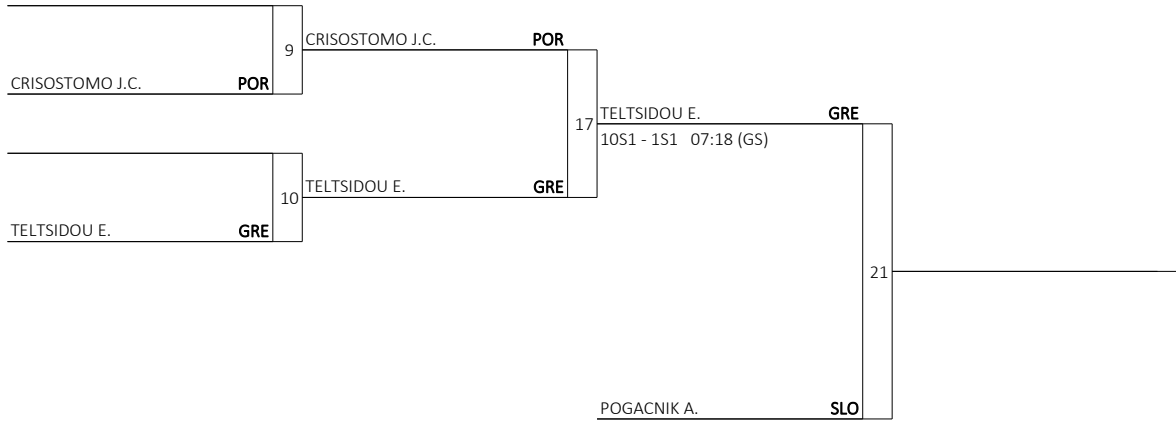



## Results summary

As of MON 4 JUL 2022

Rank	Name	Ctry	Medal
1	TSUNODA ROUSTANT Ai	ESP	GOLD
2	LANDOLSI Nihel	TUN	SILVER
3	TELSIDOU Elisavet	GRE	BRONZE
3	ESPOSITO Martina	ITA	BRONZE
5	POGACNIK Anka	SLO	
5	CVJETKO Lara	CRO	
7	SAMARDZIC Aleksandra	BIH	
7	CRISOSTOMO Joana Cristina	POR	
9	BELLAKEHAL Souad	ALG	
9	ISSOUFI Kaila	FRA	
9	AKDENIZ Minel	TUR	

### LEGEND

**DNS** Did not start

**DQB** Disqualified for unsportsmanlike beha **DSQ** Disqualified



## Entry List by Weight Category

Ctry	Name	Date of Birth	Height m / ft	World Rank
ALG - Algeria	OUALLAL Kaouther	27 NOV 1990	1.80 / 5' 11"	
CRO - Croatia	PAVIC Petrunjela	14 NOV 2000	1.80 / 5' 11"	
ESP - Spain	PEREZ GOMEZ Lucia	16 SEP 1999	1.75 / 5' 9"	
FRA - France	BUTTIGIEG Chloe	2 AUG 1997	1.70 / 5' 7"	
ITA - Italy	POLITI Linda	28 AUG 1992		
KOS - Kosovo	KUKA Loriana	5 APR 1997	1.77 / 5' 10"	
LBN - Lebanon	TARABAY Natacha	21 SEP 2004	1.80 / 5' 11"	
MAR - Morocco	YATIM Hafsa	30 JAN 1998	1.70 / 5' 7"	
MNE - Montenegro	PEKOVIC Jovana	16 JAN 1998	1.65 / 5' 5"	
SLO - Slovenia	LOBNIK Metka	9 APR 2001	1.68 / 5' 6"	
TUR - Turkiye	YILMAZ Nurcan	7 OCT 1990		

TotJudoka: 11

Note:



## Draw Sheet

As of FRI 1 JUL 2022 at 16:46

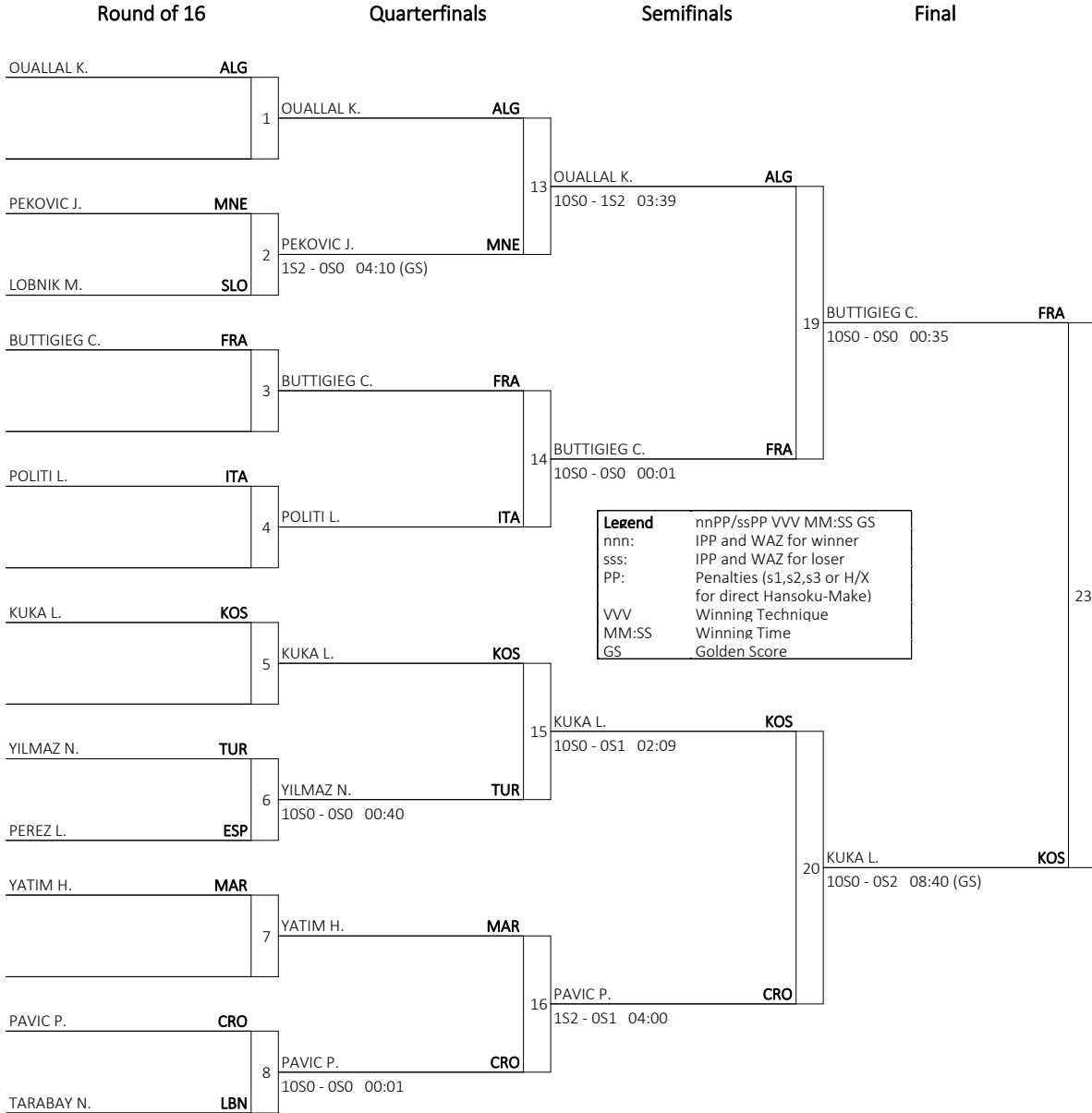

CLASSIFICATION		
1	KUKA Loriana	KOS
2	BUTTIGIEG Chloe	FRA
3	PAVIC Petrunjela	CRO
3	YILMAZ Nurcan	TUR
5	PEKOVIC Jovana	MNE
5	OUALLAL Kaouthar	ALG
7	YATIM Hafsa	MAR
8	POLITI Linda	ITA

NumJudoka: 11

**Legend**

- nnPP/ssPP VVV MM:SS GS
- nnn: IPP and WAZ for winner
- sss: IPP and WAZ for loser
- PP: Penalties (s1,s2,s3 or H/X for direct Hansoku-Make)
- VVV Winning Technique
- MM:SS Winning Time
- GS Golden Score



### Draw Sheet

Repechage (8)

Repechage

Bronze Contest

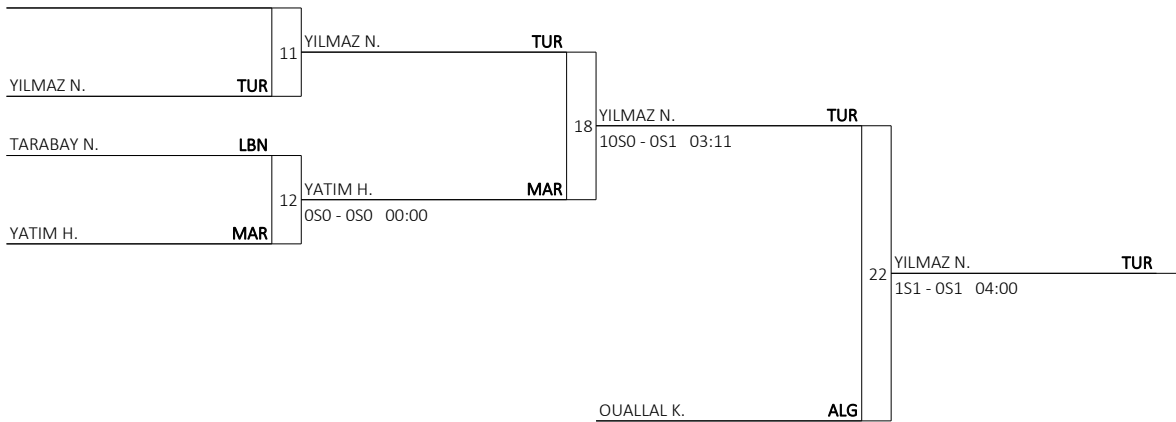
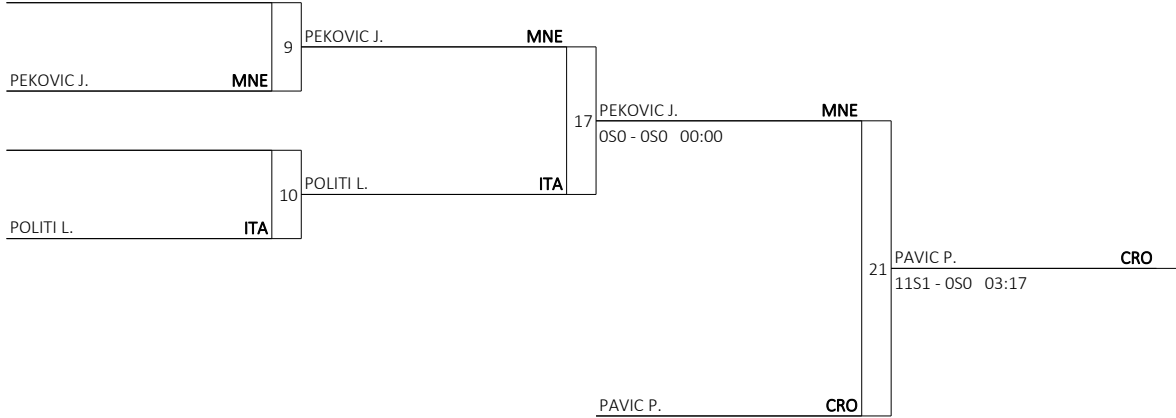



## Results summary

As of FRI 1 JUL 2022

Rank	Name	Ctry	Medal
	TARABAY Natacha	LBN	
1	KUKA Lorian	KOS	GOLD
2	BUTTIGIEG Chloe	FRA	SILVER
3	PAVIC Petrunjela	CRO	BRONZE
3	YILMAZ Nurcan	TUR	BRONZE
5	PEKOVIC Jovana	MNE	
5	OUALLAL Kaouthar	ALG	
7	YATIM Hafsa	MAR	
8	POLITI Linda	ITA	
9	PEREZ GOMEZ Lucia	ESP	
9	LOBNIK Metka	SLO	

### LEGEND

**DNS** Did not start

**DQB** Disqualified for unsportsmanlike beha **DSQ** Disqualified





## Entry List by Weight Category

Ctry	Name	Date of Birth	Height m / ft	World Rank
ALG - Algeria	ASSELAH Sonia	20 AUG 1991	1.78 / 5' 10"	
BIH - Bosnia and Herzegovina	CERIC Larisa	26 JAN 1991	1.75 / 5' 9"	
CRO - Croatia	MARANIC Ivana	12 SEP 1991	1.81 / 5' 11"	
ESP - Spain	BOUSBAA DAB Nisrin	29 AUG 2000	1.75 / 5' 9"	
FRA - France	HAYME Coralie	26 JAN 2001	1.78 / 5' 10"	
ITA - Italy	TAVANO Asya	6 JUN 2002		
SLO - Slovenia	TORKAR Urska	10 SEP 1997	1.75 / 5' 9"	
SRB - Serbia	ZABIC Milica	12 APR 1994		
TUN - Tunisia	CHEIKH ROUHOU Nihel	5 JAN 1987	1.76 / 5' 9"	
TUR - Turkiye	SAYIT Kayra	13 FEB 1988		

TotJudoka: 10

Note:



## Draw Sheet

As of FRI 1 JUL 2022 at 17:29

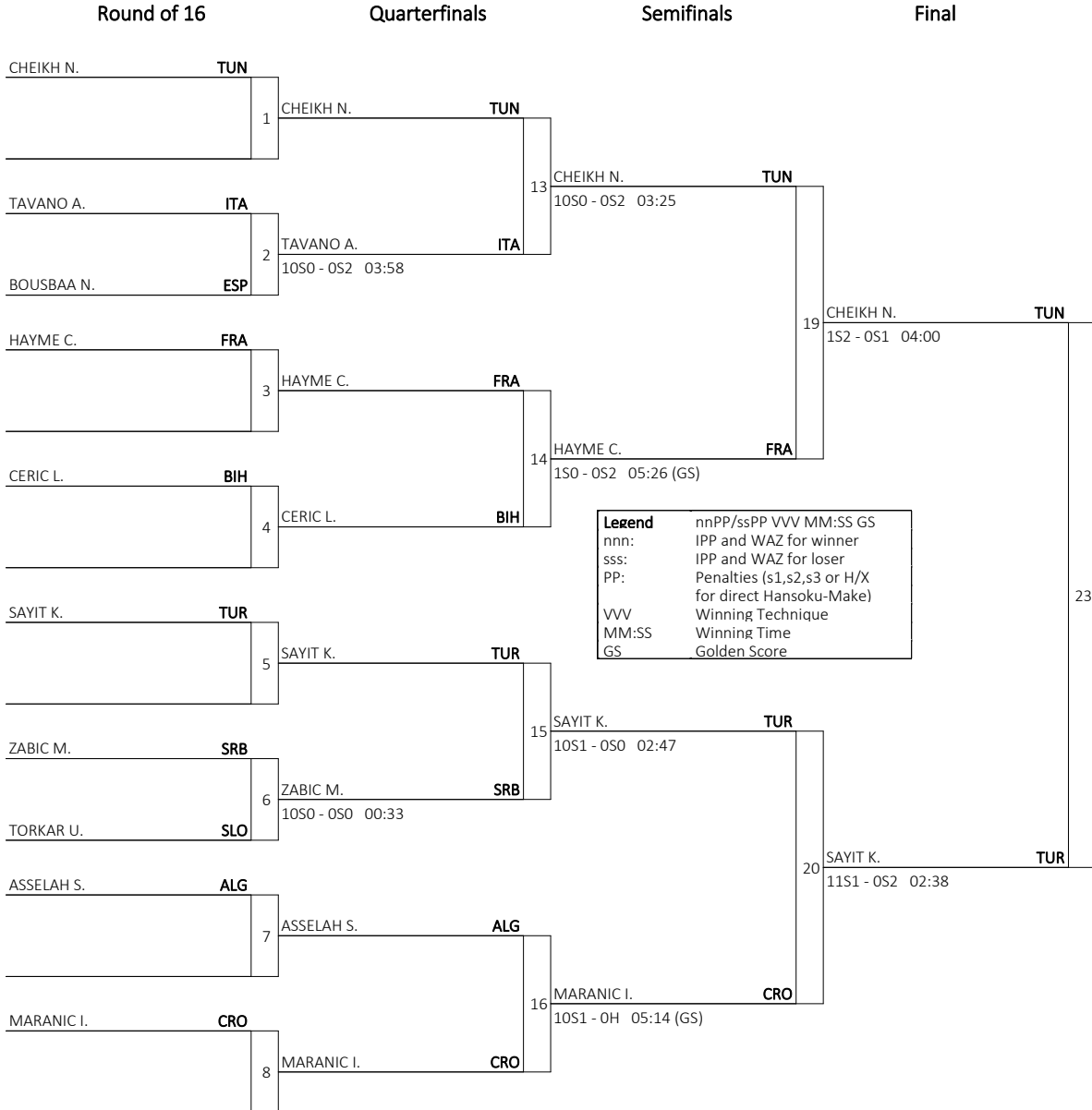

CLASSIFICATION		
1	SAYIT Kayra	TUR
2	CHEIKH ROUHOU Nihel	TUN
3	CERIC Larisa	BIH
3	HAYME Coralie	FRA
5	MARANIC Ivana	CRO
5	ZABIC Milica	SRB
7	ASSELAH Sonia	ALG
7	TAVANO Asya	ITA

NumJudoka: 10

Legend	
nnPP/ssPP VVV MM:SS GS	
nnn:	IPP and WAZ for winner
sss:	IPP and WAZ for loser
PP:	Penalties (s1,s2,s3 or H/X for direct Hansoku-Make)
VVV	Winning Technique
MM:SS	Winning Time
GS	Golden Score

SAYIT Kayra TUR  
1S2 - OS1 04:00



## Draw Sheet

Repechage (8)

Repechage

Bronze Contest

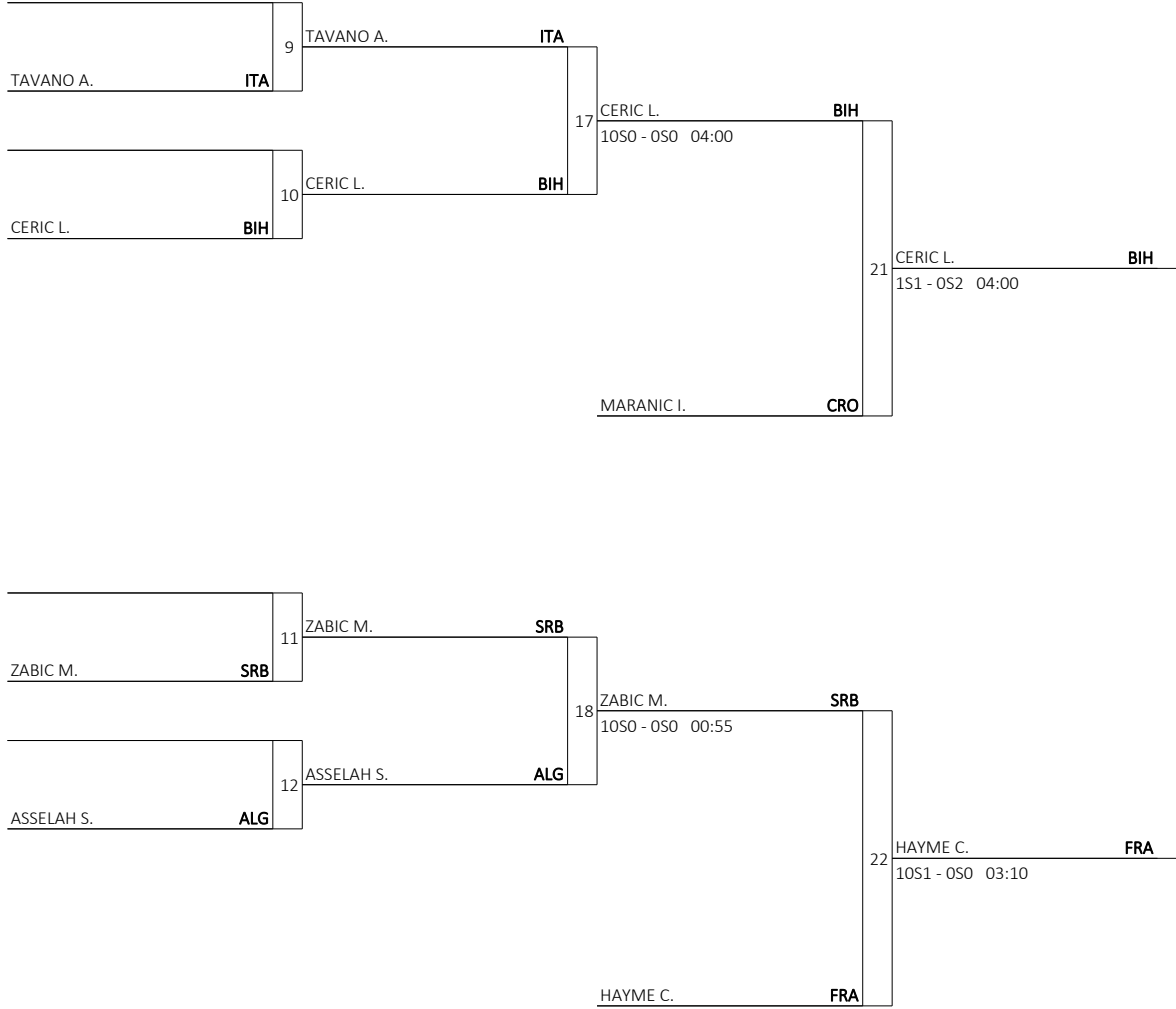



## Results summary

As of FRI 1 JUL 2022

Rank	Name	Ctry	Medal
1	SAYIT Kayra	TUR	GOLD
2	CHEIKH ROUHOU Nihel	TUN	SILVER
3	CERIC Larisa	BIH	BRONZE
3	HAYME Coralie	FRA	BRONZE
5	MARANIC Ivana	CRO	
5	ZABIC Milica	SRB	
7	ASSELAH Sonia	ALG	
7	TAVANO Asya	ITA	
9	BOUSBAA DAB Nisrin	ESP	
9	TORKAR Urska	SLO	

### LEGEND

**DNS** Did not start

**DQB** Disqualified for unsportsmanlike beha **DSQ** Disqualified



ألعاب البحر الأبيض المتوسط  
MEDITERRANEAN GAMES  
JEUX MÉDITERRANÉENS  
du 25 juin au 06 juillet

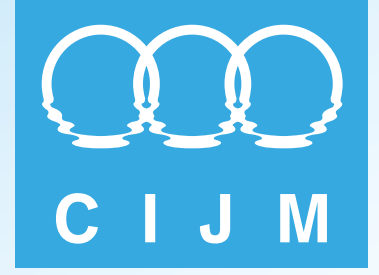

# Results Book



## Karate



**TOSYALI  
ALGERIE**

Fer et Acier

سوناطراي



sonarach



microplus  
DATA PROCESSING & TIMING  
[www.microplustiming.com](http://www.microplustiming.com)



## Competition Schedule

As of MON 27 JUN 2022

Date	Session	Start Time	Estimated Finish Time	Event / Round
SUN 26 JUN	1	09:00	20:00	Women Kumite -50kg Preliminary Rounds, Elimination Rounds, Semifinals, Finals Women Kumite -55kg Preliminary Rounds, Elimination Rounds, Semifinals, Finals Women Kumite -61kg Preliminary Rounds, Elimination Rounds, Semifinals, Finals Men Kumite -60kg Preliminary Rounds, Elimination Rounds, Semifinals, Finals Men Kumite -67kg Preliminary Rounds, Elimination Rounds, Semifinals, Finals Men Kumite -75kg Preliminary Rounds, Elimination Rounds, Semifinals, Finals
MON 27 JUN	2	09:00	20:00	Women Kumite -68kg Preliminary Rounds, Elimination Rounds, Semifinals, Finals Women Kumite +68kg Preliminary Rounds, Elimination Rounds, Semifinals, Finals Men Kumite -84kg Preliminary Rounds, Elimination Rounds, Semifinals, Finals Men Kumite +84kg Preliminary Rounds, Elimination Rounds, Semifinals, Finals



## Competition Officials

As of SAT 25 JUN 2022

Function	Name	Organisation	
Delegate	BECHIR CHERIF	TUN - Tunisia	
Referee	LANÇA CARDEIRA	POR - Portugal	
	BESART VITIA	KOS - Kosovo	
	KONSTANTINOS CHARALAMPOUS	CYP - Cyprus	
	MARIOS VATYLIOTIS	CYP - Cyprus	
	VELJKO BRNOVIC	MNE - Montenegro	
	DJELLOUL BACHIRI	ALG - Algeria	
	IOANNIS KANELIS	GRE - Greece	
	PANAGIOTIS GKOREZIS	GRE - Greece	
	ZORAN VUCKOVIC	CRO - Croatia	
	MIRO LJUB BERAK	CRO - Croatia	
	MEHMET AKIF GURBUZ	TUR - Turkey	
	PINAR GUZEL GURBUZ	TUR - Turkey	
	MOSBAH BCHIRI	TUN - Tunisia	
	MOHAMED ALI CHERIF	TUN - Tunisia	
	ZITOUNI METYOUT	MAR - Morocco	
	MOHAMED ENNAJI	MAR - Morocco	
	SALMA EL ATTAR	MAR - Morocco	
	ALBERTO MUNOZ SANTAMARIA	ESP - Spain	
	JUAN ANTONIO VELASCO LOPEZ	ESP - Spain	
	TAREK ABDELAZIM	EGY - Egypt	
	EMAD ELSERSY	EGY - Egypt	
	GIUSEPPE NOTARIANNI	ITA - Italy	
	ALESSIO GIRALDI	ITA - Italy	
	SUTERA SARDO J.	FRA - France	
	SEBASTIEN REGIS S. UHRING	FRA - France	
	JELENA PETROVIC	SRB - Serbia	
	MILOS NEGIC	SRB - Serbia	
	EMIR MEHOLJIC	BIH - Bosnia and Herzegovina	
	SRDAN SAKIC	BIH - Bosnia and Herzegovina	
	ZAHIR HAY	ALG - Algeria	
	Bout Supervisor	TOBIAS BREITENEDER	AUT - Austria
		SMAIL RABEHI	ALG - Algeria
		GIUSEPPE ZACCARO	ITA - Italy
ZITOUNI METYOUT		MAR - Morocco	
UGUR KOBAS		TUR - Turkey	
ANTREAS VASILIOU		CYP - Cyprus	
MOHAMED AHMED		EGY - Egypt	



## Entry List by NOC

As of SAT 25 JUN 2022

Country	Name	Event Name	Date of Birth
<b>ALG</b>	<b>- Algeria</b>		
	ABOURICHE Louiza	Women Kumite -55kg	4 APR 2003
	MEKDAS Loubna	Women Kumite +68kg	10 JAN 1998
	MEKKAOUI Karima	Women Kumite -68kg	9 OCT 1999
	MIDI Chaima	Women Kumite -61kg	1 FEB 1996
	OUIKENE Cylia	Women Kumite -50kg	7 SEP 2003
	BENBARA Fouad	Men Kumite -67kg	25 JUN 1994
	DAIKHI Hocine	Men Kumite +84kg	21 SEP 1996
	MIDOUNE Falleh	Men Kumite -84kg	17 SEP 2003
	SALMI Ala	Men Kumite -60kg	22 OCT 1998
	ZAID Oussama	Men Kumite -75kg	3 FEB 2000
	<b>Total athletes: 10</b>		
<b>AND</b>	<b>- Andorra</b>		
	HERVER FERNANDEZ Sandra	Women Kumite -61kg	24 NOV 1995
	<b>Total athletes: 1</b>		
<b>BIH</b>	<b>- Bosnia and Herzegovina</b>		
	CAVAR Ivona	Women Kumite -68kg	19 OCT 1995
	CORIC Iris	Women Kumite -50kg	2 FEB 2001
	KOSTIC Paola	Women Kumite -55kg	5 JUL 2003
	KRESIC Stefani	Women Kumite +68kg	10 MAY 2001
	SIPOVIC Nejra	Women Kumite -61kg	22 OCT 2003
	DUJAKOVIC Pavle	Men Kumite -60kg	15 JUL 2002
	DZUHO Rijad	Men Kumite +84kg	1 OCT 2001
	MUHOVIC Meris	Men Kumite -84kg	13 JAN 1992
	TURULJA Hamza	Men Kumite -75kg	9 AUG 2001
	<b>Total athletes: 9</b>		
<b>CRO</b>	<b>- Croatia</b>		
	HASANI Alessandra	Women Kumite -55kg	20 APR 1992
	LENARD Ana	Women Kumite -61kg	30 OCT 1990
	LESJAK Lucija	Women Kumite +68kg	30 NOV 1999
	BERAK Boran	Men Kumite -67kg	4 SEP 1996
	GARIBOVIC Enes	Men Kumite -75kg	22 APR 1996
	KVESIC Andelo	Men Kumite +84kg	8 JUN 1995





## Entry List by NOC

As of SAT 25 JUN 2022

Country	Name	Event Name	Date of Birth
	KVESIC Ivan	Men Kumite -84kg	13 OCT 1996
	<b>Total athletes: 7</b>		
<b>CYP</b>	<b>- Cyprus</b>		
	GONZALES Ariannne Miles	Women Kumite -55kg	4 FEB 2003
	KONTOU Irene	Women Kumite -50kg	17 OCT 2003
	STYLIANOU Anthi	Women Kumite -61kg	3 FEB 2002
	DEMETRIADES Demetris	Men Kumite -84kg	26 APR 2004
	LOIZIDES Panayiotis	Men Kumite -75kg	9 FEB 1993
	STYLIANOU Mathaios	Men Kumite +84kg	6 SEP 1997
	THEOPEMPTOU Christos	Men Kumite -60kg	22 SEP 2001
	ZIGKAS TSANGARAS Markos	Men Kumite -67kg	9 DEC 2000
	<b>Total athletes: 8</b>		
<b>EGY</b>	<b>- Egypt</b>		
	ABDELAZIZ Feryal	Women Kumite -68kg	16 FEB 1999
	ELSHAFEI Salma	Women Kumite -61kg	14 SEP 2000
	OKILA Menna	Women Kumite +68kg	25 MAY 2000
	SALAMA Reem	Women Kumite -50kg	19 DEC 1999
	YOUSSEF Ahlam	Women Kumite -55kg	5 DEC 1999
	ABDELAZIZ Abdalla	Men Kumite -75kg	29 MAR 1999
	ABOUKORA Amr	Men Kumite -60kg	18 NOV 2000
	BADAWY Youssef	Men Kumite -84kg	6 AUG 2001
	LOTFY Ahmed	Men Kumite -67kg	22 NOV 2002
	MAHMOUD Taha	Men Kumite +84kg	20 SEP 2000
	<b>Total athletes: 10</b>		
<b>ESP</b>	<b>- Spain</b>		
	ESPINOSA LOPEZ Maria	Women Kumite -61kg	25 FEB 1998
	FERNANDEZ OSORIO Carlota	Women Kumite -55kg	20 AUG 1995
	GIL ALVAREZ Adriana	Women Kumite -68kg	10 FEB 2001
	PINILLA SANCHEZ Alba	Women Kumite -50kg	16 FEB 2001
	TORRES GARCIA Maria	Women Kumite +68kg	22 JUL 1997
	BARGADOS BERNARDO Carlos	Men Kumite -75kg	20 JAN 1999
	ENNKHAILI ANQOUD Samy	Men Kumite -67kg	31 DEC 1997
	IBANEZ SAENZ TORRE Jose Rafael	Men Kumite -84kg	31 DEC 2000
	ORTIZ DE ZARATE Alex	Men Kumite -60kg	26 MAR 2003



## Entry List by NOC

As of SAT 25 JUN 2022

Country	Name	Event Name	Date of Birth
	SECK SAKHO Babacar	Men Kumite +84kg	12 JUN 1998
	<b>Total athletes: 10</b>		
<b>FRA</b>	<b>- France</b>		
	BONNARDE Tiphaine	Women Kumite -50kg	17 JUL 1996
	CHARIF Assma	Women Kumite -55kg	9 OCT 2002
	DARIO Maeva	Women Kumite -61kg	20 JAN 2002
	FLAMAND Natanaele	Women Kumite -68kg	13 NOV 2001
	SOMBE Tricya Sherley	Women Kumite +68kg	21 OCT 2003
	CONFIAC Hendrick	Men Kumite +84kg	12 NOV 1998
	LE Thanh-liem, Maxime	Men Kumite -75kg	20 APR 1998
	MAKAMATA Dany	Men Kumite -84kg	17 JAN 1998
	MEZIANE Rayyan	Men Kumite -60kg	10 JUN 2002
	SALMI Younesse	Men Kumite -67kg	17 MAY 2001
	<b>Total athletes: 10</b>		
<b>GRE</b>	<b>- Greece</b>		
	KYDONAKI Kyriaki	Women Kumite +68kg	7 FEB 2001
	PANETSIDOU Vasiliki	Women Kumite -68kg	18 JUL 1989
	MASTROGIANNIS Konstantinos	Men Kumite -84kg	27 DEC 2000
	TZANOS Michail Georgios	Men Kumite +84kg	15 JUL 1989
	XENOS Christos Stefanos	Men Kumite -60kg	21 MAR 2000
	XENOS Dionysios	Men Kumite -67kg	5 JUL 1995
	<b>Total athletes: 6</b>		
<b>ITA</b>	<b>- Italy</b>		
	BRUNORI Veronica	Women Kumite -55kg	14 SEP 2000
	CRIVELLI Aurora Zinovia	Women Kumite +68kg	27 JUN 2003
	MANGIACAPRA Alessandra	Women Kumite -61kg	10 JUL 1999
	PERFETTO Erminia	Women Kumite -50kg	9 JUN 1995
	SEMERARO Silvia	Women Kumite -68kg	2 MAY 1996
	BUSÀ Luigi	Men Kumite -75kg	9 OCT 1987
	CRESCENZO Angelo	Men Kumite -60kg	5 AUG 1993
	MARESCA Luca	Men Kumite -67kg	28 DEC 1993
	MARTINA Michele	Men Kumite -84kg	18 NOV 1996
	<b>Total athletes: 9</b>		
<b>KOS</b>	<b>- Kosovo</b>		
	<b>Total athletes: 9</b>		



## Entry List by NOC

As of SAT 25 JUN 2022

Country	Name	Event Name	Date of Birth
	GÉRVALLA Albulenë	Women Kumite -55kg	19 SEP 2000
	ORANA Fortesa	Women Kumite +68kg	19 OCT 1996
	RAMA Adelina	Women Kumite -61kg	28 MAR 1996
	GASHI Melos	Men Kumite -84kg	28 MAY 2003
	SHABANI Elhami	Men Kumite -75kg	19 DEC 9199
	<b>Total athletes: 5</b>		
<b>LBA</b>	<b>- Libya</b>		
	ABDUSALAM Nuri	Men Kumite +84kg	25 MAR 2004
	<b>Total athletes: 1</b>		
<b>MAR</b>	<b>- Morocco</b>		
	BROUK Nissrine	Women Kumite -68kg	2 NOV 1998
	CHAJAI Fatima-zahra	Women Kumite -61kg	26 JUN 2001
	ELHAYTI Chaimae	Women Kumite -50kg	8 MAY 2001
	MRABET LEMTI Farida	Women Kumite -55kg	1 JAN 2003
	ALAMI Anass	Men Kumite -75kg	23 MAY 2000
	ECH-CHAABI Nabil	Men Kumite -84kg	4 JUN 2001
	JINA Abdel Ali	Men Kumite -60kg	13 NOV 2002
	OUBAYA Said	Men Kumite -67kg	28 MAY 2003
	SRITI Mehdi	Men Kumite +84kg	28 SEP 2003
	<b>Total athletes: 9</b>		
<b>MK</b>	<b>- Rep. of North Macedonia</b>		
	ZABORSKA Simona	Women Kumite -61kg	16 OCT 1994
	SPASENOVSKI Petar	Men Kumite -84kg	2 APR 1998
	ZABORSKI Petar	Men Kumite -75kg	20 SEP 1997
	<b>Total athletes: 3</b>		
<b>MNE</b>	<b>- Montenegro</b>		
	JOVANOVIC Milena	Women Kumite +68kg	23 NOV 2002
	MALOVIC Nikola	Men Kumite -84kg	4 MAR 1997
	<b>Total athletes: 2</b>		
<b>POR</b>	<b>- Portugal</b>		
	HERBERT DE MATOS Constança	Women Kumite -55kg	19 JAN 2003
	PINTO LEAL Sara Filipa	Women Kumite -50kg	4 DEC 1998
	GONÇALVES DOS SANTOS Tiago Miguel	Men Kumite -75kg	26 JUN 2002



## Entry List by NOC

As of SAT 25 JUN 2022

Country	Name	Event Name	Date of Birth
	MOREIRA VALENTE Nuno Miguel	Men Kumite +84kg	18 MAR 1985
	<b>Total athletes: 4</b>		
<b>SLO</b>	<b>- Slovenia</b>		
	HABERL Ursa	Women Kumite -50kg	20 OCT 2000
	SMILJAN Kiti	Women Kumite -68kg	4 JUL 1999
	JOKSIMOVIC Stefan	Men Kumite +84kg	6 NOV 1998
	TAMSE MARINIC Niklas	Men Kumite -60kg	17 MAR 2003
	<b>Total athletes: 4</b>		
<b>SRB</b>	<b>- Serbia</b>		
	PEROVIC Ivana	Women Kumite +68kg	5 JAN 2002
	RADICEVIC Marina	Women Kumite -68kg	24 JUN 1998
	ZIVKOVIC Tamara	Women Kumite -61kg	25 AUG 2002
	BREZANCIC Vladimir	Men Kumite -84kg	23 JUL 1999
	JOKSIC Stefan	Men Kumite -67kg	26 MAR 1992
	SALAPURA Dorde	Men Kumite -75kg	26 JUN 1998
	TESANOVIC Dorde	Men Kumite +84kg	23 JUL 1999
	<b>Total athletes: 7</b>		
<b>TUN</b>	<b>- Tunisia</b>		
	BEN HASSEN Islem	Women Kumite -50kg	24 NOV 1999
	JEMI Chehinez	Women Kumite +68kg	29 APR 1997
	MAHJOUB Wafa	Women Kumite -61kg	19 MAY 2001
	ZARATI Chirine	Women Kumite -55kg	16 DEC 2002
	BOUALLAGUI Ramez	Men Kumite -75kg	10 MAR 2003
	CHOIYA Housseem Edine	Men Kumite +84kg	22 MAY 2001
	RFIGUI Mohamed Aziz	Men Kumite -60kg	12 OCT 2002
	SLIMANI Thamer	Men Kumite -84kg	7 JUN 1999
	<b>Total athletes: 8</b>		
<b>TUR</b>	<b>- Turkey</b>		
	ELTEMUR Eda	Women Kumite -68kg	11 APR 1999
	GOZUTOK Gulbahar	Women Kumite -61kg	2 JAN 2002
	HOCAGLU AKYOL Meltem	Women Kumite +68kg	15 JAN 1992
	OZCELIK ARAPOGLU Serap	Women Kumite -50kg	18 FEB 1988
	YAKAN Tugba	Women Kumite -55kg	8 JAN 1991
	AKTAS Ugur	Men Kumite -84kg	10 OCT 1995



## Entry List by NOC

As of SAT 25 JUN 2022

Country	Name	Event Name	Date of Birth
	ARSLAN Omer Faruk	Men Kumite +84kg	16 OCT 2000
	ELTEMUR Erman	Men Kumite -75kg	11 MAY 1993
	SAMDAN Eray	Men Kumite -60kg	25 JUL 1997
	UYGUR Burak	Men Kumite -67kg	11 JAN 2000
	<b>Total athletes: 10</b>		



## Number of Entries by Country

As of SAT 25 JUN 2022

Country	Entries by Event										Number of Athletes		
	Men					Women					Men	Women	Total
	60	67	75	84	84+	50	55	61	68	68+			
ALG	1	1	1	1	1	1	1	1	1	1	5	5	10
AND								1			0	1	1
BIH	1		1	1	1	1	1	1	1	1	4	5	9
CRO		1	1	1	1		1	1		1	4	3	7
CYP	1	1	1	1	1	1	1	1			5	3	8
EGY	1	1	1	1	1	1	1	1	1	1	5	5	10
ESP	1	1	1	1	1	1	1	1	1	1	5	5	10
FRA	1	1	1	1	1	1	1	1	1	1	5	5	10
GRE	1	1		1	1				1	1	4	2	6
ITA	1	1	1	1		1	1	1	1	1	4	5	9
KOS			1	1			1	1		1	2	3	5
LBA					1						1	0	1
MAR	1	1	1	1	1	1	1	1	1		5	4	9
MKD			1	1				1			2	1	3
MNE				1						1	1	1	2
POR			1		1	1	1				2	2	4
SLO	1				1	1			1		2	2	4
SRB		1	1	1	1			1	1	1	4	3	7
TUN	1		1	1	1	1	1	1	1	1	4	4	8
TUR	1	1	1	1	1	1	1	1	1	1	5	5	10
<b>Total: 20</b>	<b>12</b>	<b>11</b>	<b>15</b>	<b>16</b>	<b>15</b>	<b>12</b>	<b>13</b>	<b>15</b>	<b>11</b>	<b>13</b>	<b>69</b>	<b>64</b>	<b>133</b>



## Medallists by Event

As of MON 27 JUN 2022 at 16:28

After 10 of 10 Events

Event Name	Date	Medal	Name	Ctry Code
Women Kumite +68kg	MON 27 JUN 2022	GOLD	KYDONAKI Kyriaki	GRE
		SILVER	JOVANOVIC Milena	MNE
		BRONZE	HOCAOGLU AKYOL Meltem	TUR
		BRONZE	JEMI Chehinez	TUN
Women Kumite -50kg	SUN 26 JUN 2022	GOLD	OUIKENE Cylia	ALG
		SILVER	SALAMA Reem	EGY
		BRONZE	ELHAYTI Chaimae	MAR
		BRONZE	PINILLA SANCHEZ Alba	ESP
Women Kumite -55kg	SUN 26 JUN 2022	GOLD	ABOURICHE Louiza	ALG
		SILVER	YOUSSEF Ahlam	EGY
		BRONZE	BRUNORI Veronica	ITA
		BRONZE	YAKAN Tuqba	TUR
Women Kumite -61kg	SUN 26 JUN 2022	GOLD	MIDI Chaima	ALG
		SILVER	MAHJOUB Wafa	TUN
		BRONZE	MANGIACAPRA Alessandra	ITA
		BRONZE	SIPOVIC Neira	BIH
Women Kumite -68kg	MON 27 JUN 2022	GOLD	ABDELAZIZ Feryal	EGY
		SILVER	SEMERARO Silvia	ITA
		BRONZE	BROUK Nissrine	MAR
		BRONZE	ELTEMUR Eda	TUR
Men Kumite +84kg	MON 27 JUN 2022	GOLD	KVESIC Andelo	CRO
		SILVER	DAIKHI Hocine	ALG
		BRONZE	DZUHO Riïad	BIH
		BRONZE	SRITI Mehdi	MAR
Men Kumite -60kg	SUN 26 JUN 2022	GOLD	SAMDAN Erav	TUR
		SILVER	SALMI Ala	ALG
		BRONZE	ABOUKORA Amr	EGY
		BRONZE	MEZIANE Rayyan	FRA
Men Kumite -67kg	SUN 26 JUN 2022	GOLD	XENOS Dionysios	GRE
		SILVER	MARESCA Luca	ITA
		BRONZE	LOTFY Ahmed	EGY
		BRONZE	ZIGKAS TSANGARAS Markos	CYP
Men Kumite -75kg	SUN 26 JUN 2022	GOLD	ZAID Oussama	ALG
		SILVER	ABDELAZIZ Abdalla	EGY
		BRONZE	BUSA' Luïqi	ITA
		BRONZE	TURULJA Hamza	BIH
Men Kumite -84kg	MON 27 JUN 2022	GOLD	BADAWY Youssef	EGY
		SILVER	BREZANCIC Vladimir	SRB
		BRONZE	AKTAS Ugur	TUR
		BRONZE	KVESIC Ivan	CRO



## Medal Standings

As of MON 27 JUN 2022 at 20:18

After 10 of 10 Events

Rank	Country	Men				Women				Total				Rank by total
		G	S	B	Tot	G	S	B	Tot	G	S	B	Tot	
1	ALG - Algeria	1	2		3	3			3	4	2		6	2
2	EGY - Egypt	1	1	2	4	1	2		3	2	3	2	7	1
3	GRE - Greece	1			1	1			1	2			2	= 7
4	TUR - Turkiye	1		1	2			3	3	1		4	5	= 3
5	CRO - Croatia	1		1	2					1		1	2	= 7
6	ITA - Italy		1	1	2		1	2	3		2	3	5	= 3
7	TUN - Tunisia						1	1	2		1	1	2	= 7
8	MNE - Montenegro						1		1		1		1	= 10
8	SRB - Serbia		1		1						1		1	= 10
10	BIH - Bosnia and Herzegovina			2	2			1	1			3	3	= 5
10	MAR - Morocco			1	1			2	2			3	3	= 5
12	CYP - Cyprus			1	1							1	1	= 10
12	ESP - Spain							1	1			1	1	= 10
12	FRA - France			1	1							1	1	= 10
<b>Total:</b>		<b>5</b>	<b>5</b>	<b>10</b>	<b>20</b>	<b>5</b>	<b>5</b>	<b>10</b>	<b>20</b>	<b>10</b>	<b>10</b>	<b>20</b>	<b>40</b>	

### LEGEND

= Equal indicates the same rank  
Tot Total

B Bronze

G Gold

S Silver





## Final Classification by Event

As of MON 27 JUN 2022 at 16:29

Rank	Name	Ctry Code
<b>Women's Kumite -50kg</b>		
Gold	OUIKENE Cylia	ALG
Silver	SALAMA Reem	EGY
Bronze	ELHAYTI Chaimae	MAR
Bronze	PINILLA SANCHEZ Alba	ESP
5	HABERL Ursa	SLO
5	OZCELIK ARAPOGLU Serap	TUR
7	BEN HASSEN Islem	TUN
7	KONTOU Irene	CYP
7	PINTO LEAL Sara Filipa	POR
10	BONNARDE Tiphaine	FRA
10	CORIC Iris	BIH
10	PERFETTO Erminia	ITA
<b>Women's Kumite -55kg</b>		
Gold	ABOURICHE Louiza	ALG
Silver	YOUSSEF Ahlam	EGY
Bronze	BRUNORI Veronica	ITA
Bronze	YAKAN Tugba	TUR
5	GÉRVALLA Albulenë	KOS
5	GONZALES Ariannne Miles	CYP
7	CHARIF Assma	FRA
7	HASANI Alessandra	CRO
7	MRABET LEMTI Farida	MAR
7	ZARATI Chirine	TUN
11	FERNANDEZ OSORIO Carlota	ESP
11	HERBERT DE MATOS Constança	POR
11	KOSTIC Paola	BIH
<b>Women's Kumite -61kg</b>		
Gold	MIDI Chaima	ALG
Silver	MAHJOUB Wafa	TUN
Bronze	MANGIACAPRA Alessandra	ITA
Bronze	SIPOVIC Neira	BIH
5	DARIO Maeva	FRA
5	STYLIANOU Anthi	CYP
7	ELSHAFEI Salma	EGY
7	ESPINOSA LOPEZ Maria	ESP
7	HERVER FERNANDEZ Sandra	AND
7	ZIVKOVIC Tamara	SRB
11	CHAJAI Fatima-zahra	MAR
11	GOZUTOK Gulbahar	TUR
11	LENARD Ana	CRO
11	RAMA Adelina	KOS
11	ZABORSKA Simona	MKD
<b>Women's Kumite -68kg</b>		
Gold	ABDELAZIZ Feryal	EGY
Silver	SEMERARO Silvia	ITA
Bronze	BROUK Nissrine	MAR
Bronze	ELTEMUR Eda	TUR
5	PANETSIDOU Vasiliki	GRE
5	SMILJAN Kiti	SLO
7	FLAMAND Natanaele	FRA
7	RADICEVIC Marina	SRB
9	CAVAR Ivona	BIH
9	GIL ALVAREZ Adriana	ESP
9	MEKKAUI Karima	ALG



## Final Classification by Event

As of MON 27 JUN 2022 at 16:29

Rank	Name	Ctry Code
<b>Women's Kumite +68kg</b>		
	Gold KYDONAKI Kyriaki	GRE
	Silver JOVANOVIC Milena	MNE
	Bronze HOCAOGLU AKYOL Meltem	TUR
	Bronze JEMI Chehinez	TUN
	5 CRIVELLI Aurora Zinovia	ITA
	5 TORRES GARCIA Maria	ESP
<b>Men's Kumite -60kg</b>		
	Gold SAMDAN Eray	TUR
	Silver SALMI Ala	ALG
	Bronze ABOUKORA Amr	EGY
	Bronze MEZIANE Rayyan	FRA
	5 CRESCENZO Angelo	ITA
	5 DUJAKOVIC Pavle	BIH
	7 JINA Abdel Ali	MAR
	7 RFIGUI Mohamed Aziz	TUN
	7 TAMSE MARINIC Niklas	SLO
	7 XENOS Christos Stefanos	GRE
	11 ORTIZ DE ZARATE Alex	ESP
	11 THEOPEMPTOU Christos	CYP
<b>Men's Kumite -67kg</b>		
	Gold XENOS Dionysios	GRE
	Silver MARESCA Luca	ITA
	Bronze LOTFY Ahmed	EGY
	Bronze ZIGKAS TSANGARAS Markos	CYP
	5 OUBAYA Said	MAR
	5 SALMI Younesse	FRA
	7 JOKSIC Stefan	SRB
	7 UYGUR Burak	TUR
	9 BENBARA Fouad	ALG
	9 BERAK Boran	CRO
	9 ENNKHALI ANQOUD Samy	ESP
<b>Men's Kumite -75kg</b>		
	Gold ZAID Oussama	ALG
	Silver ABDELAZIZ Abdalla	EGY
	Bronze BUSA' Luiqi	ITA
	Bronze TURULJA Hamza	BIH
	5 ELTEMUR Erman	TUR
	5 GARIBOVIC Enes	CRO
	7 BARGADOS BERNARDO Carlos	ESP
	7 GONCALVES DOS SANTOS Tiaao Miquel	POR
	7 LE Thanh-liem, Maxime	FRA
	7 LOIZIDES Panaviotis	CYP
	11 ALAMI Anass	MAR
	11 BOUALLAGUI Ramez	TUN
	11 SALAPURA Dorde	SRB
	11 SHABANI Elhami	KOS
	11 ZABORSKI Petar	MKD



## Final Classification by Event

As of MON 27 JUN 2022 at 16:29

Rank	Name	Ctry Code
<b>Men's Kumite -84kg</b>		
Gold	BADAWY Youssef	EGY
Silver	BREZANCIC Vladimir	SRB
Bronze	AKTAS Uqur	TUR
Bronze	KVESIC Ivan	CRO
5	IBANEZ SAENZ TORRE Jose Rafael	ESP
5	MIDOUNE Falleh	ALG
7	ECH-CHAABI Nabil	MAR
7	MAKAMATA Danv	FRA
7	MALOVIC Nikola	MNE
7	MARTINA Michele	ITA
11	DEMETRIADES Demetris	CYP
11	GASHI Melos	KOS
11	MASTROGIANNIS Konstantinos	GRE
11	MUHOVIC Meris	BIH
11	SLIMANI Thamer	TUN
11	SPASENOVSKI Petar	MKD
<b>Men's Kumite +84kg</b>		
Gold	KVESIC Andelo	CRO
Silver	DAIKHI Hocine	ALG
Bronze	DZUHO Rijad	BIH
Bronze	SRITI Mehdi	MAR
5	CHOIYA Houssef Edine	TUN
5	MOREIRA VALENTE Nuno Miquel	POR
7	CONFIAC Hendrick	FRA
7	SECK SAKHO Babacar	ESP
7	TZANOS Michail Georgios	GRE
10	ABDULSALAM Nuri	LBA
10	ARSLAN Omer Faruk	TUR
10	JOKSIMOVIC Stefan	SLO
10	MAHMOUD Taha	EGY
10	STYLIANOU Mathaios	CYP
10	TESANOVIC Dorde	SRB



26 JUN 2022

## Session Results

Start time 09:00

Session 1

MAT 1							
Bout No.	Time	Event Name	Round	Colour	Name	Ctry	Result
1	09:00	Women Kumite -50kg	Round of 16	Red	ELHAYTI Chaimae	MAR	2
Finished				Blue	CORIC Iris	BIH	1
2	09:08	Women Kumite -55kg	Round of 16	Red	FERNANDEZ OSORIO Carlota	ESP	0
Finished				Blue	BRUNORI Veronica	ITA	2
3	09:16	Women Kumite -50kg	Round of 16	Red	BEN HASSEN Islem	TUN	1
Finished				Blue	PERFETTO Erminia	ITA	0
4	09:24	Women Kumite -55kg	Round of 16	Red	ABOURICHE Louiza	ALG	4
Finished				Blue	HASANI Alessandra	CRO	2
5	09:32	Women Kumite -50kg	Round of 16	Red	HABERL Ursa	SLO	0
Finished				Blue	BONNARDE Tiphaine	FRA	0
6	09:40	Women Kumite -55kg	Round of 16	Red	CHARIF Assma	FRA	5
Finished				Blue	KOSTIC Paola	BIH	2
7	09:48	Women Kumite -50kg	Round of 16	Red	PINILLA SANCHEZ Alba	ESP	0
Finished				Blue	OUIKENE Cylia	ALG	0
8	09:56	Women Kumite -55kg	Round of 16	Red	MRABET LEMTI Farida	MAR	0
Finished				Blue	YOUSSEF Ahlam	EGY	6
9	10:08	Women Kumite -55kg	Round of 16	Red	HERBERT DE MATOS Constança	POR	1
Finished				Blue	YAKAN Tugba	TUR	7
10	10:16	Women Kumite -50kg	Quarter-finals	Red	ELHAYTI Chaimae	MAR	1
Finished				Blue	SALAMA Reem	EGY	5
11	10:24	Women Kumite -55kg	Quarter-finals	Red	BRUNORI Veronica	ITA	2
Finished				Blue	ABOURICHE Louiza	ALG	9
12	10:32	Women Kumite -50kg	Quarter-finals	Red	BEN HASSEN Islem	TUN	0
Finished				Blue	OZCELIK ARAPOGLU Serap	TUR	0
13	10:40	Women Kumite -55kg	Quarter-finals	Red	CHARIF Assma	FRA	0
Finished				Blue	GÉRVALLA Albulenë	KOS	3
14	10:48	Women Kumite -50kg	Quarter-finals	Red	HABERL Ursa	SLO	1
Finished				Blue	KONTOU Irene	CYP	0
15	10:56	Women Kumite -55kg	Quarter-finals	Red	YOUSSEF Ahlam	EGY	7
Finished				Blue	GONZALES Ariannne Miles	CYP	1
16	11:08	Women Kumite -50kg	Quarter-finals	Red	OUIKENE Cylia	ALG	2
Finished				Blue	PINTO LEAL Sara Filipa	POR	0
17	11:16	Women Kumite -55kg	Quarter-finals	Red	YAKAN Tugba	TUR	8
Finished				Blue	ZARATI Chirine	TUN	0
18	11:24	Women Kumite -50kg	Semi-finals	Red	SALAMA Reem	EGY	1
Finished				Blue	OZCELIK ARAPOGLU Serap	TUR	1
19	11:32	Women Kumite -55kg	Semi-finals	Red	ABOURICHE Louiza	ALG	7
Finished				Blue	GÉRVALLA Albulenë	KOS	0
20	11:40	Women Kumite -50kg	Semi-finals	Red	HABERL Ursa	SLO	0
Finished				Blue	OUIKENE Cylia	ALG	1
21	11:48	Women Kumite -55kg	Semi-finals	Red	YOUSSEF Ahlam	EGY	8
Finished				Blue	YAKAN Tugba	TUR	0
23	12:40	Women Kumite -50kg	Repechage Round 1	Red	PINILLA SANCHEZ Alba	ESP	4
Finished				Blue	PINTO LEAL Sara Filipa	POR	1
24	12:48	Women Kumite -55kg	Repechage Round 1	Red	HASANI Alessandra	CRO	1
Finished				Blue	BRUNORI Veronica	ITA	2
25	12:56	Women Kumite -55kg	Repechage Round 1	Red	MRABET LEMTI Farida	MAR	2
Finished				Blue	GONZALES Ariannne Miles	CYP	2
26	15:32	Women Kumite -61kg	Round of 16	Red	GOZUTOK Gulbahar	TUR	4
Finished				Blue	DARIO Maeva	FRA	4
27	15:40	Women Kumite -61kg	Round of 16	Red	CHAJAI Fatima-zahra	MAR	0
Finished				Blue	ELSHAFEI Salma	EGY	0
28	15:48	Women Kumite -61kg	Round of 16	Red	MAHJOUR Wafa	TUN	1
Finished				Blue	SIPOVIC Nejra	BIH	0



26 JUN 2022

## Session Results

Start time 09:00

Session 1

MAT 1								
Bout No.	Time	Event Name	Round	Colour	Name	Ctry	Result	
29	15:56	Women Kumite -61kg	Round of 16	Red	ZABORSKA Simona	MKD	3	
Finished				Blue	ZIVKOVIC Tamara	SRB	3	
30	16:04	Women Kumite -61kg	Round of 16	Red	MIDI Chaima	ALG	1	
Finished				Blue	HERVER FERNANDEZ Sandra	AND	0	
31	16:12	Women Kumite -61kg	Round of 16	Red	STYLIANOU Anthi	CYP	2	
Finished				Blue	RAMA Adelina	KOS	0	
32	16:20	Women Kumite -61kg	Round of 16	Red	LENARD Ana	CRO	1	
Finished				Blue	ESPINOSA LOPEZ Maria	ESP	2	
33	16:32	Women Kumite -61kg	Quarter-finals	Red	DARIO Maeva	FRA	5	
Finished				Blue	ELSHAFEI Salma	EGY	3	
34	16:40	Women Kumite -61kg	Quarter-finals	Red	MAHJOUR Wafa	TUN	8	
Finished				Blue	ZIVKOVIC Tamara	SRB	2	
35	16:48	Women Kumite -61kg	Quarter-finals	Red	MIDI Chaima	ALG	3	
Finished				Blue	STYLIANOU Anthi	CYP	0	
36	16:56	Women Kumite -61kg	Quarter-finals	Red	ESPINOSA LOPEZ Maria	ESP	0	
Finished				Blue	MANGIACAPRA Alessandra	ITA	1	
37	17:05	Women Kumite -61kg	Semi-finals	Red	DARIO Maeva	FRA	1	
Finished				Blue	MAHJOUR Wafa	TUN	8	
38	17:15	Women Kumite -61kg	Semi-finals	Red	MIDI Chaima	ALG	2	
Finished				Blue	MANGIACAPRA Alessandra	ITA	0	
39	17:25	Women Kumite -61kg	Repechage Round 1	Red	SIPOVIC Nejra	BIH	4	
Finished				Blue	ZIVKOVIC Tamara	SRB	0	
40	17:33	Women Kumite -61kg	Repechage Round 1	Red	HERVER FERNANDEZ Sandra	AND	2	
Finished				Blue	STYLIANOU Anthi	CYP	2	



26 JUN 2022

## Session Results

Start time 09:00

Session 1

MAT 2							
Bout No.	Time	Event Name	Round	Colour	Name	Ctry	Result
41 Finished	13:00	Women Kumite -50kg	Bronze-medal Contest	Red Blue	ELHAYTI Chaimae OZCELIK ARAPOGLU Serap	MAR TUR	2 0
42 Finished	13:08	Women Kumite -50kg	Bronze-medal Contest	Red Blue	PINILLA SANCHEZ Alba HABERL Ursa	ESP SLO	4 4
1 Finished	13:20	Men Kumite -60kg	Bronze-medal Contest	Red Blue	DUJAKOVIC Pavle ABOUKORA Amr	BIH EGY	4 8
2 Finished	13:28	Men Kumite -60kg	Bronze-medal Contest	Red Blue	MEZIANE Rayyan CRESCENZO Angelo	FRA ITA	2 0
43 Finished	13:40	Women Kumite -55kg	Bronze-medal Contest	Red Blue	BRUNORI Veronica GÉRVALLA Albulenë	ITA KOS	2 1
44 Finished	13:48	Women Kumite -55kg	Bronze-medal Contest	Red Blue	GONZALES Ariannne Miles YAKAN Tugba	CYP TUR	0 0
3 Finished	14:00	Men Kumite -67kg	Bronze-medal Contest	Red Blue	LOTFY Ahmed OUBAYA Said	EGY MAR	0 0
4 Finished	14:08	Men Kumite -67kg	Bronze-medal Contest	Red Blue	SALMI Younesse ZIGKAS TSANGARAS Markos	FRA CYP	4 5
45 Finished	17:40	Women Kumite -61kg	Bronze-medal Contest	Red Blue	SIPOVIC Nejra DARIO Maeva	BIH FRA	2 1
46 Finished	17:48	Women Kumite -61kg	Bronze-medal Contest	Red Blue	STYLIANOU Anthi MANGIACAPRA Alessandra	CYP ITA	0 5
5 Finished	18:00	Men Kumite -75kg	Bronze-medal Contest	Red Blue	BUSA' Luigi GARIBOVIC Enes	ITA CRO	3 0
6 Finished	18:08	Men Kumite -75kg	Bronze-medal Contest	Red Blue	TURULJA Hamza ELTEMUR Erman	BIH TUR	3 1
47 Finished	18:20	Women Kumite -50kg	Gold-medal Contest	Red Blue	SALAMA Reem OUIKENE Cylia	EGY ALG	0 5
7 Finished	18:30	Men Kumite -60kg	Gold-medal Contest	Red Blue	SAMDAN Eray SALMI Ala	TUR ALG	5 0
48 Finished	18:40	Women Kumite -55kg	Gold-medal Contest	Red Blue	ABOURICHE Louiza YOUSSEF Ahlam	ALG EGY	4 1
8 Finished	18:50	Men Kumite -67kg	Gold-medal Contest	Red Blue	XENOS Dionysios MARESCA Luca	GRE ITA	3 2
49 Finished	19:00	Women Kumite -61kg	Gold-medal Contest	Red Blue	MAHJOUB Wafa MIDI Chaima	TUN ALG	2 3
9 Finished	19:10	Men Kumite -75kg	Gold-medal Contest	Red Blue	ABDELAZIZ Abdalla ZAID Oussama	EGY ALG	4 5



26 JUN 2022

Start time 09:00

Session 1

### Session Results

MAT 3							
Bout No.	Time	Event Name	Round	Colour	Name	Ctry	Result
10 Finished	09:00	Men Kumite -60kg	Round of 16	Red Blue	THEOPEMPTOU Christos ABOUKORA Amr	CYP EGY	0 0
11 Finished	09:08	Men Kumite -67kg	Round of 16	Red Blue	LOTFY Ahmed ENNKHAILI ANQOUD Samy	EGY ESP	3 0
12 Finished	09:16	Men Kumite -60kg	Round of 16	Red Blue	SAMDAN Eray RFIGUI Mohamed Aziz	TUR TUN	0 0
13 Finished	09:24	Men Kumite -67kg	Round of 16	Red Blue	BERAK Boran OUBAYA Said	CRO MAR	5 6
14 Finished	09:32	Men Kumite -60kg	Round of 16	Red Blue	JINA Abdel Ali ORTIZ DE ZARATE Alex	MAR ESP	5 2
15 Finished	09:40	Men Kumite -67kg	Round of 16	Red Blue	JOKSIC Stefan BENBARA Fouad	SRB ALG	3 2
16 Finished	09:48	Men Kumite -60kg	Round of 16	Red Blue	SALMI Ala TAMSE MARINIC Niklas	ALG SLO	8 0
17 Finished	09:56	Men Kumite -60kg	Quarter-finals	Red Blue	ABOUKORA Amr XENOS Christos Stefanos	EGY GRE	5 0
18 Finished	10:08	Men Kumite -67kg	Quarter-finals	Red Blue	LOTFY Ahmed XENOS Dionysios	EGY GRE	0 2
19 Finished	10:16	Men Kumite -60kg	Quarter-finals	Red Blue	SAMDAN Eray DUJAKOVIC Pavle	TUR BIH	8 0
20 Finished	10:24	Men Kumite -67kg	Quarter-finals	Red Blue	OUBAYA Said UYGUR Burak	MAR TUR	1 0
21 Finished	10:32	Men Kumite -60kg	Quarter-finals	Red Blue	JINA Abdel Ali CRESCENZO Angelo	MAR ITA	3 4
22 Finished	10:40	Men Kumite -67kg	Quarter-finals	Red Blue	JOKSIC Stefan ZIGKAS TSANGARAS Markos	SRB CYP	1 8
23 Finished	10:48	Men Kumite -60kg	Quarter-finals	Red Blue	SALMI Ala MEZIANE Rayyan	ALG FRA	2 1
24 Finished	10:56	Men Kumite -67kg	Quarter-finals	Red Blue	MARESCA Luca SALMI Younesse	ITA FRA	5 1
25 Finished	11:08	Men Kumite -60kg	Semi-finals	Red Blue	ABOUKORA Amr SAMDAN Eray	EGY TUR	1 5
26 Finished	11:16	Men Kumite -67kg	Semi-finals	Red Blue	XENOS Dionysios OUBAYA Said	GRE MAR	2 0
27 Finished	11:24	Men Kumite -60kg	Semi-finals	Red Blue	CRESCENZO Angelo SALMI Ala	ITA ALG	1 2
28 Finished	11:32	Men Kumite -67kg	Semi-finals	Red Blue	ZIGKAS TSANGARAS Markos MARESCA Luca	CYP ITA	0 4
29 Finished	12:32	Men Kumite -60kg	Repechage Round 1	Red Blue	RFIGUI Mohamed Aziz DUJAKOVIC Pavle	TUN BIH	1 2
30 Finished	12:40	Men Kumite -60kg	Repechage Round 1	Red Blue	TAMSE MARINIC Niklas MEZIANE Rayyan	SLO FRA	0 1
33 Finished	15:32	Men Kumite -75kg	Round of 16	Red Blue	BARGADOS BERNARDO Carlos ABDELAZIZ Abdalla	ESP EGY	4 6
34 Finished	15:40	Men Kumite -75kg	Round of 16	Red Blue	SHABANI Elhami BUSA' Luigi	KOS ITA	0 1
35 Finished	15:48	Men Kumite -75kg	Round of 16	Red Blue	LE Thanh-Iem, Maxime BOUALLAGUI Ramez	FRA TUN	4 1
36 Finished	15:56	Men Kumite -75kg	Round of 16	Red Blue	ZABORSKI Petar GARIBOVIC Enes	MKD CRO	0 1
37 Finished	16:04	Men Kumite -75kg	Round of 16	Red Blue	SALAPURA Dorde ELTEMUR Erman	SRB TUR	0 2
38 Finished	16:12	Men Kumite -75kg	Round of 16	Red Blue	ALAMI Anass GONÇALVES DOS SANTOS Tiago Miguel	MAR POR	5 6



26 JUN 2022

## Session Results

Start time 09:00

Session 1

MAT 3								
Bout No.	Time	Event Name	Round	Colour	Name	Ctry	Result	
39 Finished	16:20	Men Kumite -75kg	Round of 16	Red Blue	LOIZIDES Panayiotis ZAID Oussama	CYP ALG	0 5	
40 Finished	16:32	Men Kumite -75kg	Quarter-finals	Red Blue	ABDELAZIZ Abdalla BUSA' Luigi	EGY ITA	1 1	
41 Finished	16:40	Men Kumite -75kg	Quarter-finals	Red Blue	ELTEMUR Erman GONÇALVES DOS SANTOS Tiago Miguel	TUR POR	1 0	
42 Finished	16:48	Men Kumite -75kg	Quarter-finals	Red Blue	ZAID Oussama TURULJA Hamza	ALG BIH	3 0	
43 Finished	17:00	Men Kumite -75kg	Quarter-finals	Red Blue	LE Thanh-liem, Maxime GARIBOVIC Enes	FRA CRO	1 1	
44 Finished	17:10	Men Kumite -75kg	Semi-finals	Red Blue	ABDELAZIZ Abdalla GARIBOVIC Enes	EGY CRO	2 0	
45 Finished	17:20	Men Kumite -75kg	Semi-finals	Red Blue	ELTEMUR Erman ZAID Oussama	TUR ALG	0 0	
46 Finished	17:30	Men Kumite -75kg	Repechage Round 1	Red Blue	BARGADOS BERNARDO Carlos BUSA' Luigi	ESP ITA	2 5	
47 Finished	17:38	Men Kumite -75kg	Repechage Round 1	Red Blue	LOIZIDES Panayiotis TURULJA Hamza	CYP BIH	0 0	





27 JUN 2022

### Session Results

Start time 09:00

Session 2

MAT 1							
Bout No.	Time	Event Name	Round	Colour	Name	Ctry	Result
50 Finished	09:00	Women Kumite -68kg	Round of 16	Red Blue	GIL ALVAREZ Adriana BROUK Nissrine	ESP MAR	0 0
51 Finished	09:08	Women Kumite -68kg	Round of 16	Red Blue	PANETSIDOU Vasiliki CAVAR Ivona	GRE BIH	0 0
52 Finished	09:16	Women Kumite -68kg	Round of 16	Red Blue	FLAMAND Natanaele MEKKAOUI Karima	FRA ALG	4 1
53 Finished	09:25	Women Kumite -68kg	Quarter-finals	Red Blue	BROUK Nissrine RADICEVIC Marina	MAR SRB	5 3
54 Finished	09:33	Women Kumite -68kg	Quarter-finals	Red Blue	PANETSIDOU Vasiliki ABDELAZIZ Feryal	GRE EGY	0 2
55 Finished	09:41	Women Kumite -68kg	Quarter-finals	Red Blue	FLAMAND Natanaele ELTEMUR Eda	FRA TUR	3 4
56 Finished	09:49	Women Kumite -68kg	Quarter-finals	Red Blue	SMILJAN Kiti SEMERARO Silvia	SLO ITA	0 4
57 Finished	10:00	Women Kumite -68kg	Semi-finals	Red Blue	BROUK Nissrine ABDELAZIZ Feryal	MAR EGY	1 2
58 Finished	10:08	Women Kumite -68kg	Semi-finals	Red Blue	ELTEMUR Eda SEMERARO Silvia	TUR ITA	1 1
48 Finished	10:40	Men Kumite -84kg	Round of 16	Red Blue	MIDOUNE Falleh BREZANCIC Vladimir	ALG SRB	2 10
49 Finished	10:48	Men Kumite -84kg	Round of 16	Red Blue	MAKAMATA Dany GASHI Melos	FRA KOS	3 0
50 Finished	10:56	Men Kumite -84kg	Round of 16	Red Blue	DEMETRIADES Demetris KVESIC Ivan	CYP CRO	2 4
51 Finished	11:04	Men Kumite -84kg	Round of 16	Red Blue	MUHOVIC Meris MALOVIC Nikola	BIH MNE	0 2
52 Finished	11:12	Men Kumite -84kg	Round of 16	Red Blue	MASTROGIANNIS Konstantinos MARTINA Michele	GRE ITA	1 3
53 Finished	11:20	Men Kumite -84kg	Round of 16	Red Blue	IBANEZ SAENZ TORRE Jose Rafael SLIMANI Thamer	ESP TUN	1 1
54 Finished	11:28	Men Kumite -84kg	Round of 16	Red Blue	AKTAS Ugur BADAWY Youssef	TUR EGY	0 1
55 Finished	11:36	Men Kumite -84kg	Round of 16	Red Blue	SPASENOVSKI Petar ECH-CHAABI Nabil	MKD MAR	0 8
56 Finished	11:45	Men Kumite -84kg	Quarter-finals	Red Blue	BREZANCIC Vladimir MAKAMATA Dany	SRB FRA	1 1
57 Finished	11:53	Men Kumite -84kg	Quarter-finals	Red Blue	KVESIC Ivan MALOVIC Nikola	CRO MNE	3 1
58 Finished	12:01	Men Kumite -84kg	Quarter-finals	Red Blue	MARTINA Michele IBANEZ SAENZ TORRE Jose Rafael	ITA ESP	1 2
59 Finished	12:10	Men Kumite -84kg	Semi-finals	Red Blue	BREZANCIC Vladimir KVESIC Ivan	SRB CRO	4 0
60 Finished	12:18	Men Kumite -84kg	Semi-finals	Red Blue	IBANEZ SAENZ TORRE Jose Rafael BADAWY Youssef	ESP EGY	1 4
61 Finished	12:30	Men Kumite -84kg	Quarter-finals	Red Blue	BADAWY Youssef ECH-CHAABI Nabil	EGY MAR	4 2
62 Finished	13:20	Men Kumite -84kg	Repechage Round 1	Red Blue	MIDOUNE Falleh MAKAMATA Dany	ALG FRA	8 0
63 Finished	13:28	Men Kumite -84kg	Repechage Round 1	Red Blue	AKTAS Ugur ECH-CHAABI Nabil	TUR MAR	4 4



27 JUN 2022

## Session Results

Start time 09:00

Session 2

MAT 2								
Bout No.	Time	Event Name	Round	Colour	Name	Ctry	Result	
61 Finished	13:00	Women Kumite -68kg	Bronze-medal Contest	Red	PANETSIDOU Vasiliki	GRE	3	
				Blue	BROUK Nissrine	MAR	3	
62 Finished	13:08	Women Kumite -68kg	Bronze-medal Contest	Red	SMILJAN Kiti	SLO	3	
				Blue	ELTEMUR Eda	TUR	8	
63 Finished	13:20	Women Kumite +68kg	Bronze-medal Contest	Red	HOCAOGLU AKYOL Meltem	TUR	5	
				Blue	CRIVELLI Aurora Zinovia	ITA	4	
64 Finished	13:28	Women Kumite +68kg	Bronze-medal Contest	Red	TORRES GARCIA Maria	ESP	2	
				Blue	JEMI Chehinez	TUN	3	
64 Finished	13:40	Men Kumite -84kg	Bronze-medal Contest	Red	MIDOUNE Falleh	ALG	2	
				Blue	KVESIC Ivan	CRO	8	
65 Finished	13:48	Men Kumite -84kg	Bronze-medal Contest	Red	AKTAS Ugur	TUR	3	
				Blue	IBANEZ SAENZ TORRE Jose Rafael	ESP	2	
66 Finished	14:00	Men Kumite +84kg	Bronze-medal Contest	Red	CHOIYA Houssef Edine	TUN	1	
				Blue	DZUHO Rijad	BIH	2	
67 Finished	14:08	Men Kumite +84kg	Bronze-medal Contest	Red	MOREIRA VALENTE Nuno Miguel	POR	0	
				Blue	SRITI Mehdi	MAR	8	
65 Finished	15:30	Women Kumite -68kg	Gold-medal Contest	Red	ABDELAZIZ Feryal	EGY	2	
				Blue	SEMERARO Silvia	ITA	0	
68 Finished	15:40	Men Kumite -84kg	Gold-medal Contest	Red	BREZANCIC Vladimir	SRB	4	
				Blue	BADAWY Youssef	EGY	6	
66 Finished	15:50	Women Kumite +68kg	Gold-medal Contest	Red	KYDONAKI Kyriaki	GRE	2	
				Blue	JOVANOVIC Milena	MNE	1	
69 Finished	16:00	Men Kumite +84kg	Gold-medal Contest	Red	KVESIC Andelo	CRO	2	
				Blue	DAIKHI Hocine	ALG	1	



27 JUN 2022

### Session Results

Start time 09:00

Session 2

MAT 3							
Bout No.	Time	Event Name	Round	Colour	Name	Ctry	Result
67 Finished	09:00	Women Kumite +68kg	Round of 16	Red Blue	<b>HOCAOGLU AKYOL Meltem</b> <b>KYDONAKI Kyriaki</b>	TUR GRE	1 4
68 Finished	09:08	Women Kumite +68kg	Round of 16	Red Blue	<b>PEROVIC Ivana</b> LESJAK Lucija	SRB CRO	1 0
69 Finished	09:16	Women Kumite +68kg	Round of 16	Red Blue	<b>CRIVELLI Aurora Zinovia</b> KRESIC Stefani	ITA BIH	0 0
70 Finished	09:24	Women Kumite +68kg	Round of 16	Red Blue	<b>JOVANOVIC Milena</b> OKILA Menna	MNE EGY	3 2
71 Finished	09:32	Women Kumite +68kg	Round of 16	Red Blue	<b>JEMI Chehinez</b> ORANA Fortesa	TUN KOS	6 3
72 Finished	09:40	Women Kumite +68kg	Quarter-finals	Red Blue	<b>KYDONAKI Kyriaki</b> PEROVIC Ivana	GRE SRB	0 0
73 Finished	09:48	Women Kumite +68kg	Quarter-finals	Red Blue	<b>CRIVELLI Aurora Zinovia</b> SOMBE Tricya Sherley	ITA FRA	8 0
74 Finished	09:56	Women Kumite +68kg	Quarter-finals	Red Blue	<b>JOVANOVIC Milena</b> TORRES GARCIA Maria	MNE ESP	5 0
75 Finished	10:04	Women Kumite +68kg	Quarter-finals	Red Blue	<b>JEMI Chehinez</b> MEKDAS Loubna	TUN ALG	2 0
76 Finished	10:12	Women Kumite +68kg	Semi-finals	Red Blue	<b>KYDONAKI Kyriaki</b> CRIVELLI Aurora Zinovia	GRE ITA	3 0
77 Finished	10:20	Women Kumite +68kg	Semi-finals	Red Blue	<b>JOVANOVIC Milena</b> JEMI Chehinez	MNE TUN	0 0
69 Finished	10:30	Men Kumite +84kg	Round of 16	Red Blue	<b>TZANOS Michail Georgios</b> ARSLAN Omer Faruk	GRE TUR	0 0
70 Finished	10:38	Men Kumite +84kg	Round of 16	Red Blue	<b>KVESIC Andelo</b> CHOIYA Housseem Edine	CRO TUN	5 3
71 Finished	10:46	Men Kumite +84kg	Round of 16	Red Blue	ABDULSALAM Nuri <b>CONFIAC Hendrick</b>	LBA FRA	2 8
72 Finished	10:54	Men Kumite +84kg	Round of 16	Red Blue	<b>DZUHO Rijad</b> MAHMOUD Taha	BIH EGY	3 2
73 Finished	11:02	Men Kumite +84kg	Round of 16	Red Blue	<b>DAIKHI Hocine</b> TESANOVIC Dorde	ALG SRB	7 2
74 Finished	11:10	Men Kumite +84kg	Round of 16	Red Blue	<b>MOREIRA VALENTE Nuno Miguel</b> STYLIANOU Mathaios	POR CYP	6 5
75 Finished	11:18	Men Kumite +84kg	Round of 16	Red Blue	<b>SRITI Mehdi</b> JOKSIMOVIC Stefan	MAR SLO	5 0
76 Finished	11:30	Men Kumite +84kg	Quarter-finals	Red Blue	TZANOS Michail Georgios <b>KVESIC Andelo</b>	GRE CRO	0 4
77 Finished	11:38	Men Kumite +84kg	Quarter-finals	Red Blue	CONFIAC Hendrick <b>DZUHO Rijad</b>	FRA BIH	1 4
79 Finished	11:46	Men Kumite +84kg	Quarter-finals	Red Blue	<b>DAIKHI Hocine</b> MOREIRA VALENTE Nuno Miguel	ALG POR	4 1
80 Finished	11:54	Men Kumite +84kg	Quarter-finals	Red Blue	<b>SRITI Mehdi</b> SECK SAKHO Babacar	MAR ESP	11 3
81 Finished	12:05	Men Kumite +84kg	Semi-finals	Red Blue	<b>KVESIC Andelo</b> DZUHO Rijad	CRO BIH	5 1
82 Finished	12:13	Men Kumite +84kg	Semi-finals	Red Blue	<b>DAIKHI Hocine</b> SRITI Mehdi	ALG MAR	7 1
78 Finished	13:00	Women Kumite +68kg	Repechage Round 1	Red Blue	<b>HOCAOGLU AKYOL Meltem</b> PEROVIC Ivana	TUR SRB	1 0
79 Finished	13:08	Women Kumite +68kg	Repechage Round 1	Red Blue	OKILA Menna <b>TORRES GARCIA Maria</b>	EGY ESP	1 3
83 Finished	13:20	Men Kumite +84kg	Repechage Round 1	Red Blue	<b>CHOIYA Housseem Edine</b> TZANOS Michail Georgios	TUN GRE	5 0

**Note:** Names of the winners of completed contests are shown in bold text



## Entry List by Event

Ctry	Name	Date of Birth
ALG - Algeria	SALMI Ala	22 OCT 1998
BIH - Bosnia and Herzegovina	DUJAKOVIC Pavle	15 JUL 2002
CYP - Cyprus	THEOPEMPTOU Christos	22 SEP 2001
EGY - Egypt	ABOUKORA Amr	18 NOV 2000
ESP - Spain	ORTIZ DE ZARATE Alex	26 MAR 2003
FRA - France	MEZIANE Rayyan	10 JUN 2002
GRE - Greece	XENOS Christos Stefanos	21 MAR 2000
ITA - Italy	CRESCENZO Angelo	5 AUG 1993
MAR - Morocco	JINA Abdel Ali	13 NOV 2002
SLO - Slovenia	TAMSE MARINIC Niklas	17 MAR 2003
TUN - Tunisia	RFIGUI Mohamed Aziz	12 OCT 2002
TUR - Turkey	SAMDAN Eray	25 JUL 1997

Total athletes: 12



## Results Bracket - Final Phase

As of SUN 26 JUN 2022 at 18:17

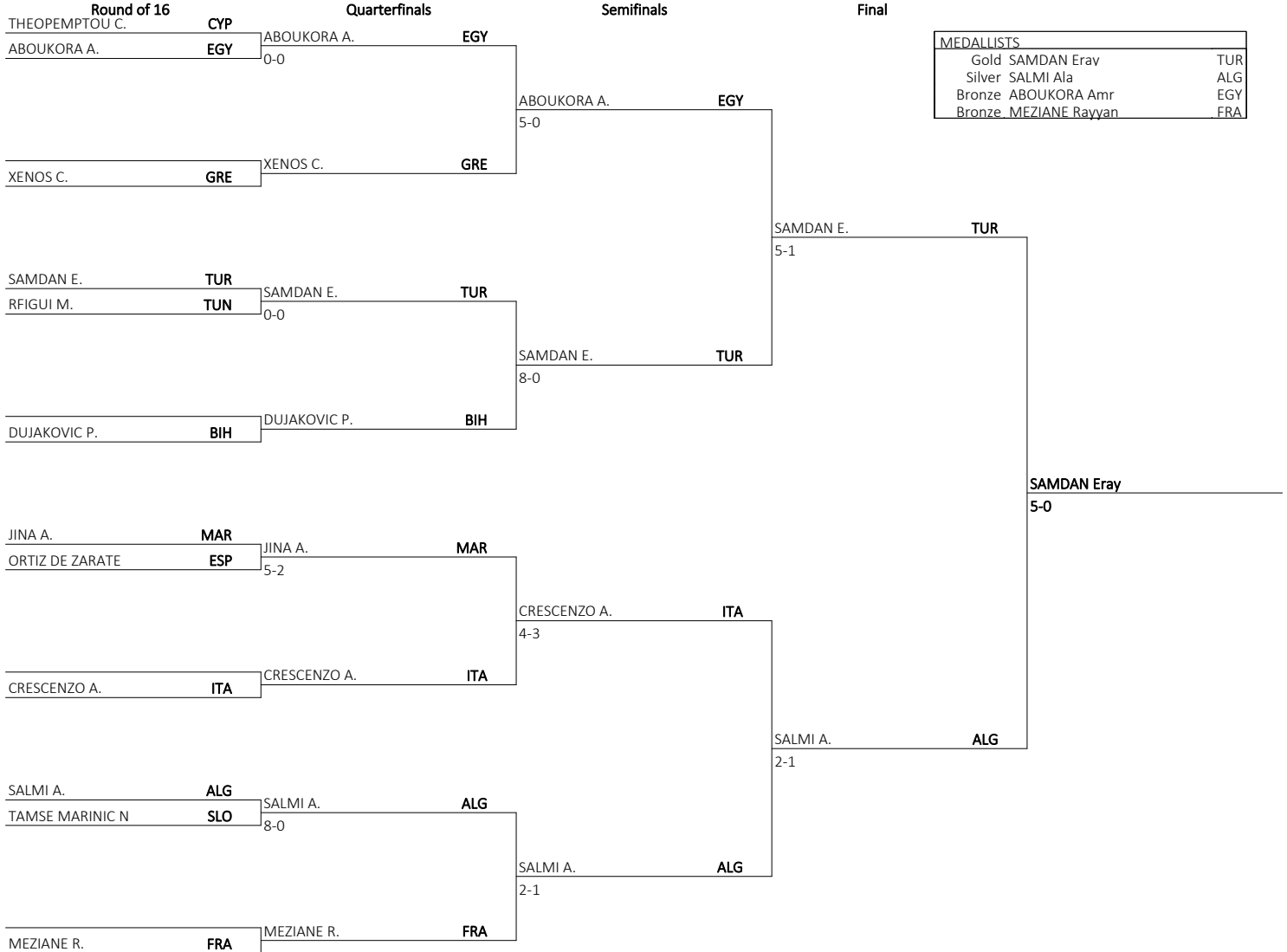

### Quarter-Finals (R)

### Bronze Contest

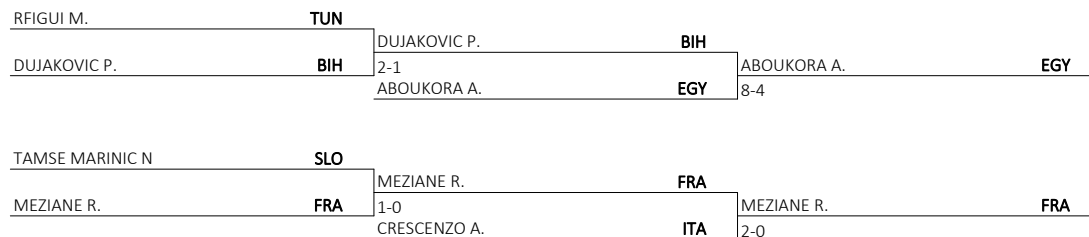



## Entry List by Event

Ctry	Name	Date of Birth
ALG - Algeria	BENBARA Fouad	25 JUN 1994
CRO - Croatia	BERAK Boran	4 SEP 1996
CYP - Cyprus	ZIGKAS TSANGARAS Markos	9 DEC 2000
EGY - Egypt	LOTFY Ahmed	22 NOV 2002
ESP - Spain	ENNKHAILI ANQOUD Samy	31 DEC 1997
FRA - France	SALMI Younesse	17 MAY 2001
GRE - Greece	XENOS Dionysios	5 JUL 1995
ITA - Italy	MARESCA Luca	28 DEC 1993
MAR - Morocco	OUBAYA Said	28 MAY 2003
SRB - Serbia	JOKSIC Stefan	26 MAR 1992
TUR - Turkey	UYGUR Burak	11 JAN 2000

Total athletes: 11



## Results Bracket - Final Phase

As of MON 4 JUL 2022 at 17:49

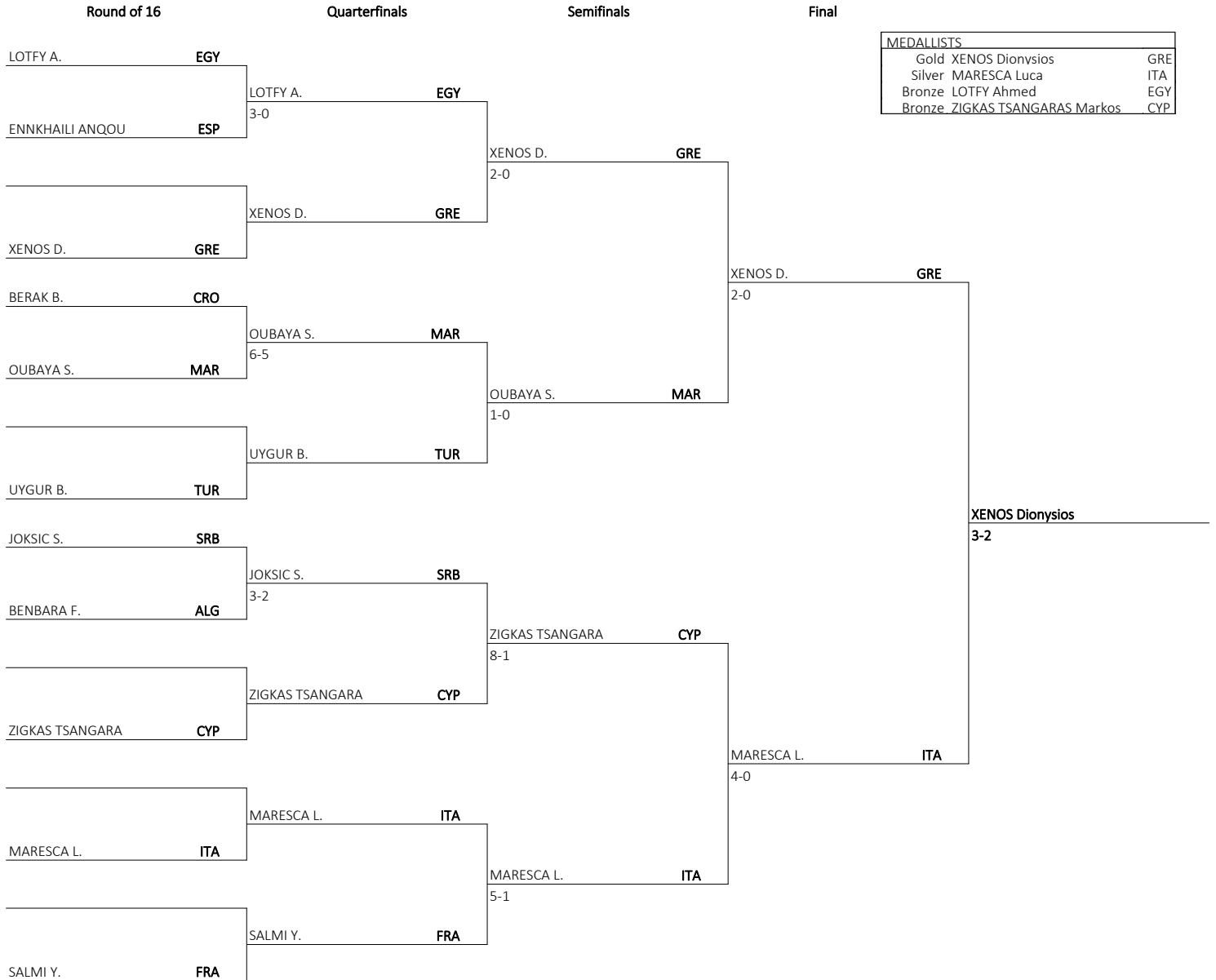

### Quarter-Finals (R)

### Bronze Contest

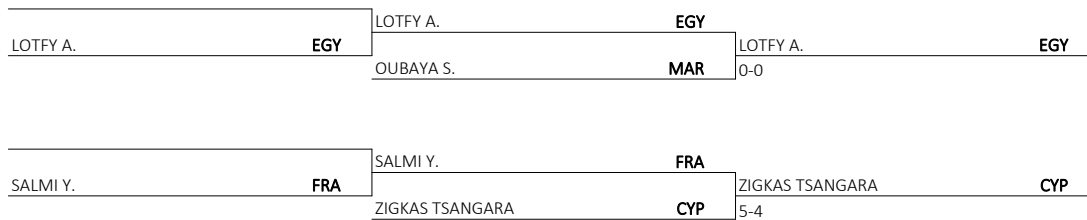



## Entry List by Event

Ctry	Name	Date of Birth
ALG - Algeria	ZAID Oussama	3 FEB 2000
BIH - Bosnia and Herzegovina	TURULJA Hamza	9 AUG 2001
CRO - Croatia	GARIBOVIC Enes	22 APR 1996
CYP - Cyprus	LOIZIDES Panayiotis	9 FEB 1993
EGY - Egypt	ABDELAZIZ Abdalla	29 MAR 1999
ESP - Spain	BARGADOS BERNARDO Carlos	20 JAN 1999
FRA - France	LE Thanh-liem, Maxime	20 APR 1998
ITA - Italy	BUSÀ Luigi	9 OCT 1987
KOS - Kosovo	SHABANI Elhami	19 DEC 9199
MAR - Morocco	ALAMI Anass	23 MAY 2000
MKD - Rep. of North Macedonia	ZABORSKI Petar	20 SEP 1997
POR - Portugal	GONÇALVES DOS SANTOS Tiago Miguel	26 JUN 2002
SRB - Serbia	SALAPURA Dorde	26 JUN 1998
TUN - Tunisia	BOUALLAGUI Ramez	10 MAR 2003
TUR - Turkey	ELTEMUR Erman	11 MAY 1993

Total athletes: 15





## Results Bracket - Final Phase

As of MON 4 JUL 2022 at 17:48

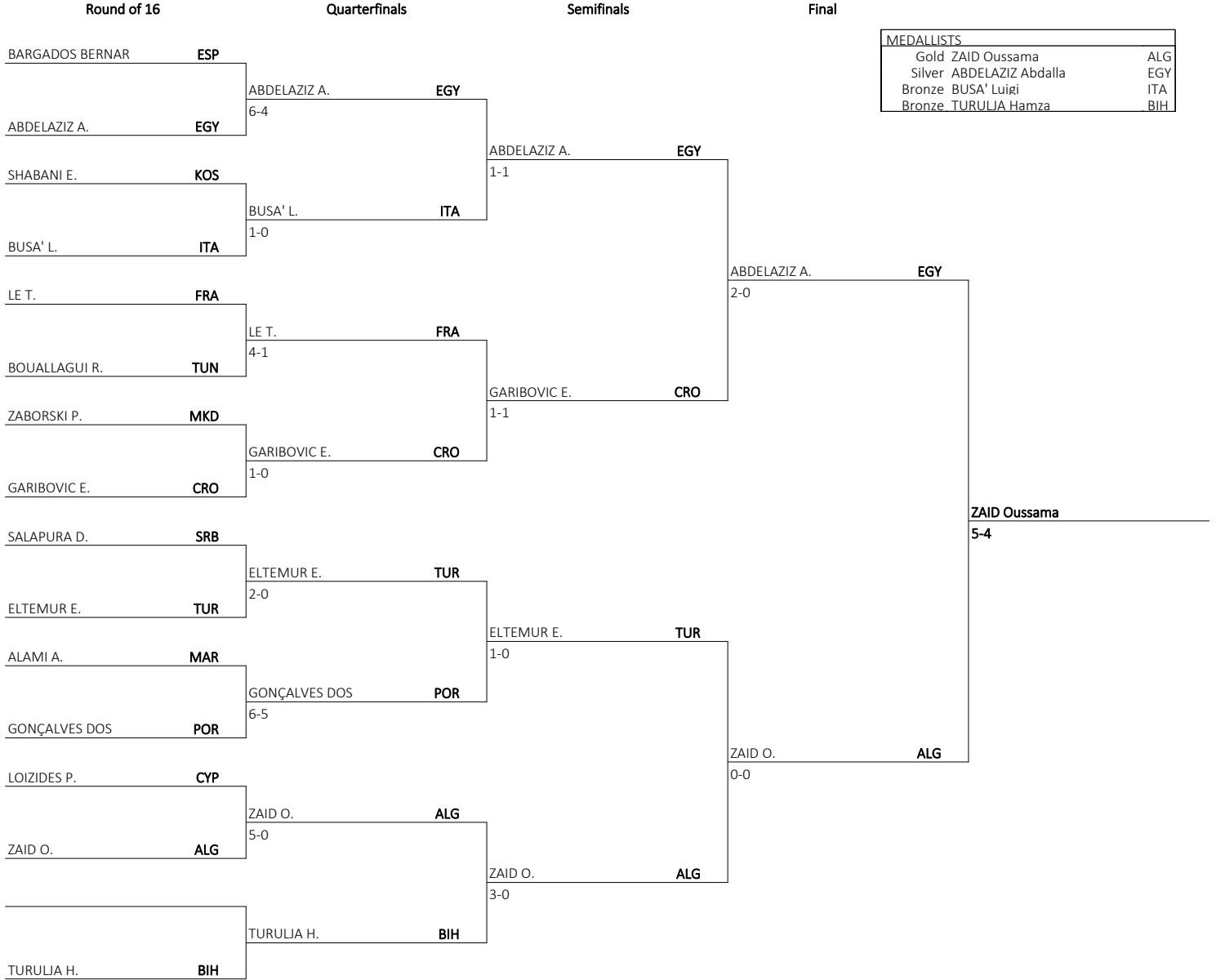

### Quarter-Finals (R)

### Bronze Contest

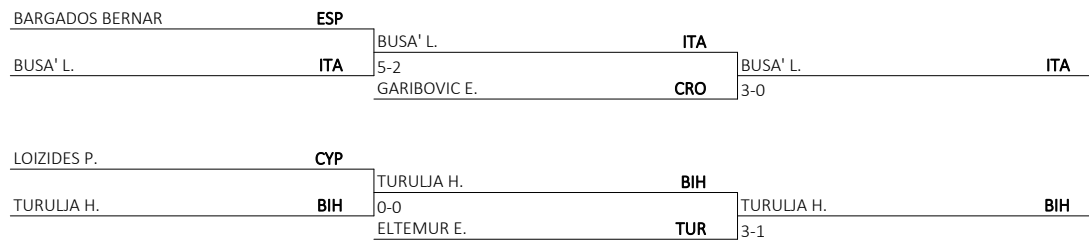



## Entry List by Event

Ctry	Name	Date of Birth
ALG - Algeria	MIDOUNE Falleh	17 SEP 2003
BIH - Bosnia and Herzegovina	MUHOVIC Meris	13 JAN 1992
CRO - Croatia	KVESIC Ivan	13 OCT 1996
CYP - Cyprus	DEMETRIADES Demetris	26 APR 2004
EGY - Egypt	BADAWY Youssef	6 AUG 2001
ESP - Spain	IBANEZ SAENZ TORRE Jose Rafael	31 DEC 2000
FRA - France	MAKAMATA Dany	17 JAN 1998
GRE - Greece	MASTROGIANNIS Konstantinos	27 DEC 2000
ITA - Italy	MARTINA Michele	18 NOV 1996
KOS - Kosovo	GASHI Melos	28 MAY 2003
MAR - Morocco	ECH-CHAABI Nabil	4 JUN 2001
MKD - Rep. of North Macedonia	SPASENOVSKI Petar	2 APR 1998
MNE - Montenegro	MALOVIC Nikola	4 MAR 1997
SRB - Serbia	BREZANCIC Vladimir	23 JUL 1999
TUN - Tunisia	SLIMANI Thamer	7 JUN 1999
TUR - Turkey	AKTAS Ugur	10 OCT 1995

Total athletes: 16



## Results Bracket - Final Phase

As of MON 27 JUN 2022 at 15:46

Round of 16		Quarterfinals		Semifinals		Final	
MIDOUNE F. (ALG)	BREZANCIC V. (SRB)	BREZANCIC V. (SRB)		BREZANCIC V. (SRB)		BREZANCIC V. (SRB)	
	10-2			1-1		4-0	
MAKAMATA D. (FRA)	GASHI M. (KOS)	MAKAMATA D. (FRA)					
	3-0						
DEMETRIADES D. (CYP)	KVESIC I. (CRO)	KVESIC I. (CRO)		KVESIC I. (CRO)			
	4-2			3-1			
MUHOVIC M. (BIH)	MALOVIC N. (MNE)	MALOVIC N. (MNE)					
	2-0						
MASTROGIANNIS K. (GRE)	MARTINA M. (ITA)	MARTINA M. (ITA)		IBANEZ SAENZ (ESP)			
	3-1			2-1			
IBANEZ SAENZ (ESP)	SLIMANI T. (TUN)	IBANEZ SAENZ (ESP)				BADAWY Y. (EGY)	
	1-1					4-1	
AKTAS U. (TUR)	BADAWY Y. (EGY)	BADAWY Y. (EGY)		BADAWY Y. (EGY)			
	1-0			4-2			
SPASENOVSKI P. (MKD)	ECH-CHAABI N. (MAR)	ECH-CHAABI N. (MAR)					
	8-0						

Quarter-Finals (R)		Bronze Contest	
MIDOUNE F. (ALG)	MAKAMATA D. (FRA)	MIDOUNE F. (ALG)	KVESIC I. (CRO)
	8-0		8-2
		KVESIC I. (CRO)	
AKTAS U. (TUR)	ECH-CHAABI N. (MAR)	AKTAS U. (TUR)	IBANEZ SAENZ (ESP)
	4-4		3-2
		IBANEZ SAENZ (ESP)	

MEDALLISTS		
Gold	BADAWY Youssef	EGY
Silver	BREZANCIC Vladimir	SRB
Bronze	AKTAS Ugur	TUR
Bronze	KVESIC Ivan	CRO

BADAWY Youssef

6-4



## Entry List by Event

Ctry	Name	Date of Birth
ALG - Algeria	DAIKHI Hocine	21 SEP 1996
BIH - Bosnia and Herzegovina	DZUHO Rijad	1 OCT 2001
CRO - Croatia	KVESIC Andelo	8 JUN 1995
CYP - Cyprus	STYLIANOU Mathaios	6 SEP 1997
EGY - Egypt	MAHMOUD Taha	20 SEP 2000
ESP - Spain	SECK SAKHO Babacar	12 JUN 1998
FRA - France	CONFIAC Hendrick	12 NOV 1998
GRE - Greece	TZANOS Michail Georgios	15 JUL 1989
LBA - Libya	ABDULSALAM Nuri	25 MAR 2004
MAR - Morocco	SRITI Mehdi	28 SEP 2003
POR - Portugal	MOREIRA VALENTE Nuno Miguel	18 MAR 1985
SLO - Slovenia	JOKSIMOVIC Stefan	6 NOV 1998
SRB - Serbia	TESANOVIC Dorde	23 JUL 1999
TUN - Tunisia	CHOIYA Housseem Edine	22 MAY 2001
TUR - Turkey	ARSLAN Omer Faruk	16 OCT 2000

Total athletes: 15



## Results Bracket - Final Phase

As of MON 4 JUL 2022 at 17:49

Round of 16	Quarterfinals	Semifinals	Final
TZANOS M. GRE	TZANOS M. GRE	KVESIC A. CRO	KVESIC A. CRO
ARSLAN O. TUR	0-0	4-0	5-1
KVESIC A. CRO	KVESIC A. CRO	DZUHO R. BIH	KVESIC A. CRO
CHOIYA H. TUN	5-3	4-1	2-1
ABDUSALAM N. LBA	CONFIAC H. FRA	DAIKHI H. ALG	DAIKHI H. ALG
CONFIAC H. FRA	8-2	4-1	7-1
DZUHO R. BIH	DZUHO R. BIH	MOREIRA VALENTE POR	MOREIRA VALENTE POR
MAHMOUD T. EGY	3-2	6-5	8-0
DAIKHI H. ALG	DAIKHI H. ALG	SRITI M. MAR	SRITI M. MAR
TESANOVIC D. SRB	7-2	11-3	
MOREIRA VALENTE POR	MOREIRA VALENTE POR	SECK SAKHO B. ESP	
STYLIANOU M. CYP	6-5		
SRITI M. MAR	SRITI M. MAR		
JOKSIMOVIC S. SLO	5-0		
SECK SAKHO B. ESP	SECK SAKHO B. ESP		

MEDALLISTS		
Gold	KVESIC Andelo	CRO
Silver	DAIKHI Hocine	ALG
Bronze	DZUHO Rijad	BIH
Bronze	SRITI Mehdi	MA

Quarter-Finals (R)	Bronze Contest
CHOIYA H. TUN	CHOIYA H. TUN
TZANOS M. GRE	DZUHO R. BIH
	2-1
MOREIRA VALENTE POR	MOREIRA VALENTE POR
	SRITI M. MAR
	8-0



## Entry List by Event

Ctry	Name	Date of Birth
ALG - Algeria	OUIKENE Cylia	7 SEP 2003
BIH - Bosnia and Herzegovina	CORIC Iris	2 FEB 2001
CYP - Cyprus	KONTOU Irene	17 OCT 2003
EGY - Egypt	SALAMA Reem	19 DEC 1999
ESP - Spain	PINILLA SANCHEZ Alba	16 FEB 2001
FRA - France	BONNARDE Tiphaine	17 JUL 1996
ITA - Italy	PERFETTO Erminia	9 JUN 1995
MAR - Morocco	ELHAYTI Chairmae	8 MAY 2001
POR - Portugal	PINTO LEAL Sara Filipa	4 DEC 1998
SLO - Slovenia	HABERL Ursa	20 OCT 2000
TUN - Tunisia	BEN HASSEN Islem	24 NOV 1999
TUR - Turkey	OZCELIK ARAPOGLU Serap	18 FEB 1988

Total athletes: 12



Results Bracket - Final Phase

REVISED  
SUN 26 JUN 18:08

As of SUN 26 JUN 2022 at 18:08

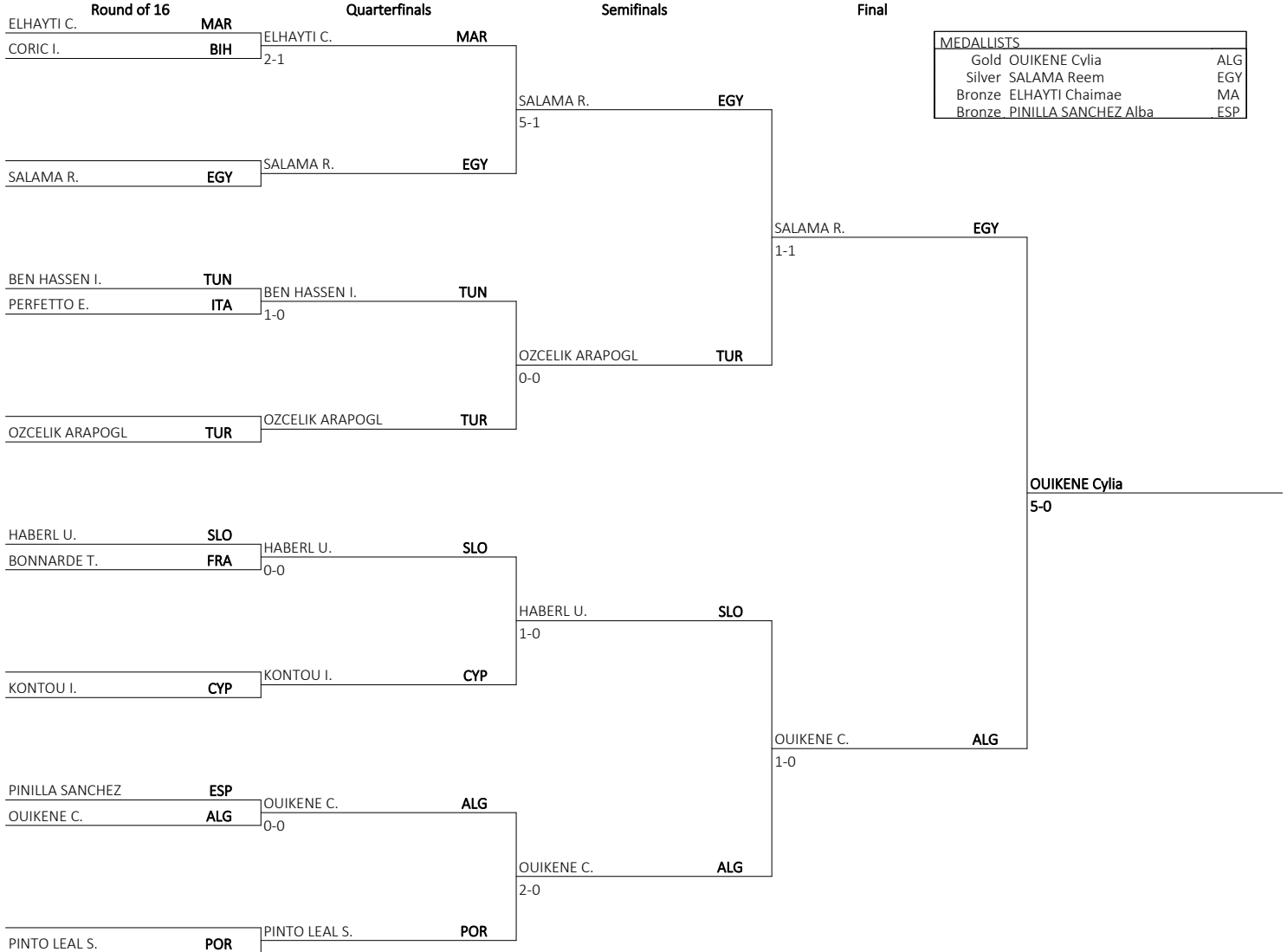

MEDALLISTS		
Gold	OUIKENE Cylia	ALG
Silver	SALAMA Reem	EGY
Bronze	ELHAYTI Chaimae	MA
Bronze	PINILLA SANCHEZ Alba	ESP

Quarter-Finals (R)

Bronze Contest

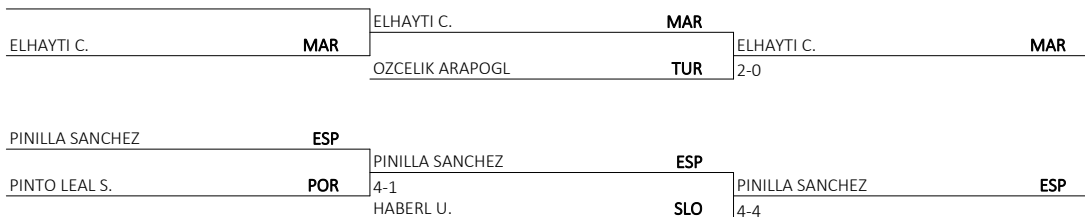



## Entry List by Event

Ctry	Name	Date of Birth
ALG - Algeria	ABOURICHE Louiza	4 APR 2003
BIH - Bosnia and Herzegovina	KOSTIC Paola	5 JUL 2003
CRO - Croatia	HASANI Alessandra	20 APR 1992
CYP - Cyprus	GONZALES Arianne Miles	4 FEB 2003
EGY - Egypt	YOUSSEF Ahlam	5 DEC 1999
ESP - Spain	FERNANDEZ OSORIO Carlota	20 AUG 1995
FRA - France	CHARIF Assma	9 OCT 2002
ITA - Italy	BRUNORI Veronica	14 SEP 2000
KOS - Kosovo	GËRVALLA Albulenë	19 SEP 2000
MAR - Morocco	MRABET LEMTI Farida	1 JAN 2003
POR - Portugal	HERBERT DE MATOS Constança	19 JAN 2003
TUN - Tunisia	ZARATI Chirine	16 DEC 2002
TUR - Turkey	YAKAN Tugba	8 JAN 1991

Total athletes: 13





## Results Bracket - Final Phase

As of MON 4 JUL 2022 at 17:47

Round of 16	Quarterfinals	Semifinals	Final															
FERNANDEZ OSORI <b>ESP</b>	BRUNORI V. <b>ITA</b>	ABOURICHE L. <b>ALG</b>	<table border="1"> <thead> <tr> <th colspan="3">MEDALLISTS</th> </tr> </thead> <tbody> <tr> <td>Gold</td> <td>ABOURICHE Louiza</td> <td>ALG</td> </tr> <tr> <td>Silver</td> <td>YOUSSEF Ahlam</td> <td>EGY</td> </tr> <tr> <td>Bronze</td> <td>BRUNORI Veronica</td> <td>ITA</td> </tr> <tr> <td>Bronze</td> <td>YAKAN Tugba</td> <td>TUR</td> </tr> </tbody> </table>	MEDALLISTS			Gold	ABOURICHE Louiza	ALG	Silver	YOUSSEF Ahlam	EGY	Bronze	BRUNORI Veronica	ITA	Bronze	YAKAN Tugba	TUR
MEDALLISTS																		
Gold	ABOURICHE Louiza	ALG																
Silver	YOUSSEF Ahlam	EGY																
Bronze	BRUNORI Veronica	ITA																
Bronze	YAKAN Tugba	TUR																
BRUNORI V. <b>ITA</b>	2-0	9-2																
ABOURICHE L. <b>ALG</b>	ABOURICHE L. <b>ALG</b>	7-0																
HASANI A. <b>CRO</b>	4-2	3-0																
CHARIF A. <b>FRA</b>	CHARIF A. <b>FRA</b>	ABOURICHE L. <b>ALG</b>																
KOSTIC P. <b>BIH</b>	5-2	GÉRVALLA A. <b>KOS</b>																
GÉRVALLA A. <b>KOS</b>	GÉRVALLA A. <b>KOS</b>	7-0																
MRABET LEMTI F. <b>MAR</b>	YOUSSEF A. <b>EGY</b>	ABOURICHE Louiza <b>ALG</b>																
YOUSSEF A. <b>EGY</b>	6-0	4-1																
GONZALES A. <b>CYP</b>	GONZALES A. <b>CYP</b>	7-1																
HERBERT DE MATO <b>POR</b>	YAKAN T. <b>TUR</b>	8-0																
YAKAN T. <b>TUR</b>	7-1	8-0																
ZARATI C. <b>TUN</b>	ZARATI C. <b>TUN</b>	8-0																

### Quarter-Finals (R)

### Bronze Contest

HASANI A. <b>CRO</b>	BRUNORI V. <b>ITA</b>	BRUNORI V. <b>ITA</b>
BRUNORI V. <b>ITA</b>	2-1	2-1
	GÉRVALLA A. <b>KOS</b>	
MRABET LEMTI F. <b>MAR</b>	GONZALES A. <b>CYP</b>	YAKAN T. <b>TUR</b>
GONZALES A. <b>CYP</b>	2-2	0-0
	YAKAN T. <b>TUR</b>	



## Entry List by Event

Ctry	Name	Date of Birth
ALG - Algeria	MIDI Chaima	1 FEB 1996
AND - Andorra	HERVER FERNANDEZ Sandra	24 NOV 1995
BIH - Bosnia and Herzegovina	SIPOVIC Nejra	22 OCT 2003
CRO - Croatia	LENARD Ana	30 OCT 1990
CYP - Cyprus	STYLIANOU Anthi	3 FEB 2002
EGY - Egypt	ELSHAFEI Salma	14 SEP 2000
ESP - Spain	ESPINOSA LOPEZ Maria	25 FEB 1998
FRA - France	DARIO Maeva	20 JAN 2002
ITA - Italy	MANGIACAPRA Alessandra	10 JUL 1999
KOS - Kosovo	RAMA Adelina	28 MAR 1996
MAR - Morocco	CHAJAI Fatima-zahra	26 JUN 2001
MKD - Rep. of North Macedonia	ZABORSKA Simona	16 OCT 1994
SRB - Serbia	ZIVKOVIC Tamara	25 AUG 2002
TUN - Tunisia	MAHJOUB Wafa	19 MAY 2001
TUR - Turkey	GOZUTOK Gulbahar	2 JAN 2002

Total athletes: 15



## Results Bracket - Final Phase

As of MON 4 JUL 2022 at 17:45

Round of 16	Quarterfinals	Semifinals	Final															
GOZUTOK G. <b>TUR</b>	DARIO M. <b>FRA</b>	DARIO M. <b>FRA</b>	<table border="1"> <thead> <tr> <th colspan="3">MEDALLISTS</th> </tr> </thead> <tbody> <tr> <td>Gold</td> <td>MIDI Chaima</td> <td>ALG</td> </tr> <tr> <td>Silver</td> <td>MAHJOUB Wafa</td> <td>TU</td> </tr> <tr> <td>Bronze</td> <td>MANGIACAPRA Alessandra</td> <td>ITA</td> </tr> <tr> <td>Bronze</td> <td>SIPOVIC Nejra</td> <td>BIH</td> </tr> </tbody> </table>	MEDALLISTS			Gold	MIDI Chaima	ALG	Silver	MAHJOUB Wafa	TU	Bronze	MANGIACAPRA Alessandra	ITA	Bronze	SIPOVIC Nejra	BIH
MEDALLISTS																		
Gold	MIDI Chaima	ALG																
Silver	MAHJOUB Wafa	TU																
Bronze	MANGIACAPRA Alessandra	ITA																
Bronze	SIPOVIC Nejra	BIH																
DARIO M. <b>FRA</b>	4-4	5-3																
CHAJAI F. <b>MAR</b>	ELSHAFEI S. <b>EGY</b>	MAHJOUB W. <b>TUN</b>																
ELSHAFEI S. <b>EGY</b>	0-0	8-1																
MAHJOUB W. <b>TUN</b>	MAHJOUB W. <b>TUN</b>	8-2																
SIPOVIC N. <b>BIH</b>	1-0	MAHJOUB W. <b>TUN</b>																
ZABORSKA S. <b>MKD</b>	ZIVKOVIC T. <b>SRB</b>	3-3																
ZIVKOVIC T. <b>SRB</b>	3-3																	
MIDI C. <b>ALG</b>	MIDI C. <b>ALG</b>																	
HERVER FERNANDE <b>AND</b>	1-0	MIDI C. <b>ALG</b>																
STYLIANOU A. <b>CYP</b>	STYLIANOU A. <b>CYP</b>	3-0																
RAMA A. <b>KOS</b>	2-0	MIDI C. <b>ALG</b>																
LENARD A. <b>CRO</b>	ESPINOSA LOPEZ <b>ESP</b>	2-0																
ESPINOSA LOPEZ <b>ESP</b>	2-1	MIDI C. <b>ALG</b>																
	MANGIACAPRA A. <b>ITA</b>	1-0																
MANGIACAPRA A. <b>ITA</b>																		

### Quarter-Finals (R)

### Bronze Contest

SIPOVIC N. <b>BIH</b>	SIPOVIC N. <b>BIH</b>	SIPOVIC N. <b>BIH</b>
ZIVKOVIC T. <b>SRB</b>	4-0	DARIO M. <b>FRA</b>
		2-1
HERVER FERNANDE <b>AND</b>	STYLIANOU A. <b>CYP</b>	MANGIACAPRA A. <b>ITA</b>
STYLIANOU A. <b>CYP</b>	2-2	5-0
	MANGIACAPRA A. <b>ITA</b>	



## Entry List by Event

Ctry	Name	Date of Birth
ALG - Algeria	MEKKAOUI Karima	9 OCT 1999
BIH - Bosnia and Herzegovina	CAVAR Ivona	19 OCT 1995
EGY - Egypt	ABDELAZIZ Feryal	16 FEB 1999
ESP - Spain	GIL ALVAREZ Adriana	10 FEB 2001
FRA - France	FLAMAND Natanaele	13 NOV 2001
GRE - Greece	PANETSIDOU Vasiliki	18 JUL 1989
ITA - Italy	SEMERARO Silvia	2 MAY 1996
MAR - Morocco	BROUK Nissrine	2 NOV 1998
SLO - Slovenia	SMILJAN Kiti	4 JUL 1999
SRB - Serbia	RADICEVIC Marina	24 JUN 1998
TUR - Turkey	ELTEMUR Eda	11 APR 1999

Total athletes: 11



## Results Bracket - Final Phase

As of MON 27 JUN 2022 at 15:41

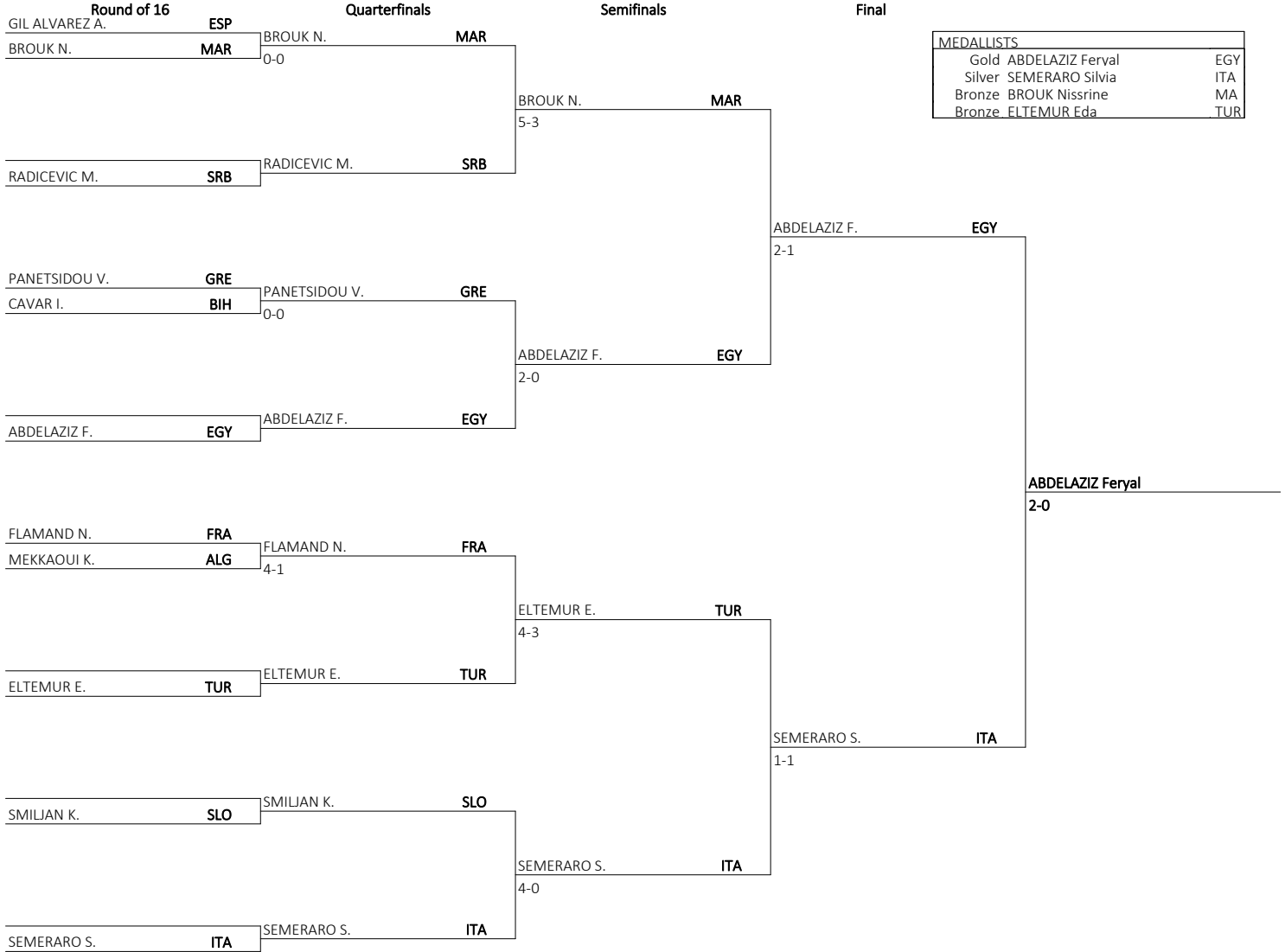

MEDALLISTS		
Gold	ABDELAZIZ Feryal	EGY
Silver	SEMERARO Silvia	ITA
Bronze	BROUK Nissrine	MA
Bronze	ELTEMUR Eda	TUR

**Quarter-Finals (R)**

**Bronze Contest**

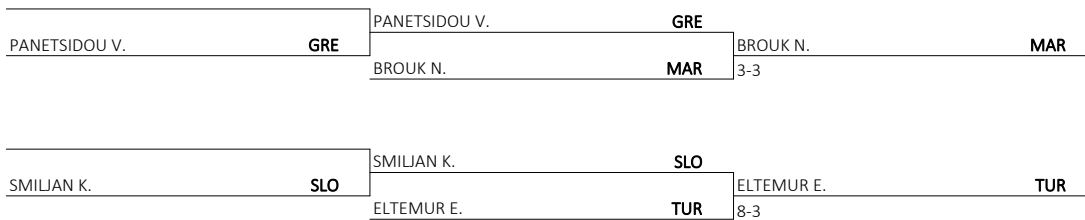



## Entry List by Event

Ctry	Name	Date of Birth
ALG - Algeria	MEKDAS Loubna	10 JAN 1998
BIH - Bosnia and Herzegovina	KRESIC Stefani	10 MAY 2001
CRO - Croatia	LESJAK Lucija	30 NOV 1999
EGY - Egypt	OKILA Menna	25 MAY 2000
ESP - Spain	TORRES GARCIA Maria	22 JUL 1997
FRA - France	SOMBE Tricya Sherley	21 OCT 2003
GRE - Greece	KYDONAKI Kyriaki	7 FEB 2001
ITA - Italy	CRIVELLI Aurora Zinovia	27 JUN 2003
KOS - Kosovo	ORANA Fortesa	19 OCT 1996
MNE - Montenegro	JOVANOVIC Milena	23 NOV 2002
SRB - Serbia	PEROVIC Ivana	5 JAN 2002
TUN - Tunisia	JEMI Chehinez	29 APR 1997
TUR - Turkey	HOCAOGLU AKYOL Meltem	15 JAN 1992

Total athletes: 13



## Results Bracket - Final Phase

As of MON 4 JUL 2022 at 17:46

Round of 16	Quarterfinals	Semifinals	Final															
HOCAOGLU AKYOL <b>TUR</b>	KYDONAKI K. <b>GRE</b> 4-1	KYDONAKI K. <b>GRE</b> 0-0	<table border="1"> <thead> <tr> <th colspan="3">MEDALLISTS</th> </tr> </thead> <tbody> <tr> <td>Gold</td> <td>KYDONAKI Kyriaki</td> <td>GRE</td> </tr> <tr> <td>Silver</td> <td>JOVANOVIC Milena</td> <td>MN</td> </tr> <tr> <td>Bronze</td> <td>HOCAOGLU AKYOL Meltem</td> <td>TUR</td> </tr> <tr> <td>Bronze</td> <td>JEMI Chehinez</td> <td>TU</td> </tr> </tbody> </table>	MEDALLISTS			Gold	KYDONAKI Kyriaki	GRE	Silver	JOVANOVIC Milena	MN	Bronze	HOCAOGLU AKYOL Meltem	TUR	Bronze	JEMI Chehinez	TU
MEDALLISTS																		
Gold	KYDONAKI Kyriaki	GRE																
Silver	JOVANOVIC Milena	MN																
Bronze	HOCAOGLU AKYOL Meltem	TUR																
Bronze	JEMI Chehinez	TU																
KYDONAKI K. <b>GRE</b>	PEROVIC I. <b>SRB</b> 1-0	PEROVIC I. <b>SRB</b>																
PEROVIC I. <b>SRB</b>	LESJAK L. <b>CRO</b> 1-0	LESJAK L. <b>CRO</b>																
LESJAK L. <b>CRO</b>	CRIVELLI A. <b>ITA</b> 0-0	CRIVELLI A. <b>ITA</b>																
CRIVELLI A. <b>ITA</b>	KRESIC S. <b>BIH</b> 0-0	KRESIC S. <b>BIH</b>																
KRESIC S. <b>BIH</b>	SOMBE T. <b>FRA</b> 8-0	SOMBE T. <b>FRA</b>																
SOMBE T. <b>FRA</b>	JOVANOVIC M. <b>MNE</b> 3-2	JOVANOVIC M. <b>MNE</b>																
JOVANOVIC M. <b>MNE</b>	OKILA M. <b>EGY</b> 3-2	OKILA M. <b>EGY</b>																
OKILA M. <b>EGY</b>	TORRES GARCIA M <b>ESP</b> 5-0	TORRES GARCIA M <b>ESP</b>																
TORRES GARCIA M <b>ESP</b>	JEMI C. <b>TUN</b> 2-0	JEMI C. <b>TUN</b>																
JEMI C. <b>TUN</b>	ORANA F. <b>KOS</b> 6-3	ORANA F. <b>KOS</b>																
ORANA F. <b>KOS</b>	MEKDAS L. <b>ALG</b> 2-0	MEKDAS L. <b>ALG</b>																
MEKDAS L. <b>ALG</b>																		

### Quarter-Finals (R)

### Bronze Contest

HOCAOGLU AKYOL <b>TUR</b>	HOCAOGLU AKYOL <b>TUR</b>	HOCAOGLU AKYOL <b>TUR</b>
PEROVIC I. <b>SRB</b>	PEROVIC I. <b>SRB</b> 1-0 CRIVELLI A. <b>ITA</b>	CRIVELLI A. <b>ITA</b> 5-4
OKILA M. <b>EGY</b>	TORRES GARCIA M <b>ESP</b>	TORRES GARCIA M <b>ESP</b>
TORRES GARCIA M <b>ESP</b>	TORRES GARCIA M <b>ESP</b> 3-1 JEMI C. <b>TUN</b>	JEMI C. <b>TUN</b> 3-2



ألعاب البحر الأبيض المتوسط  
MEDITERRANEAN GAMES  
JEUX MÉDITERRANÉENS  
du 25 juin au 06 juillet

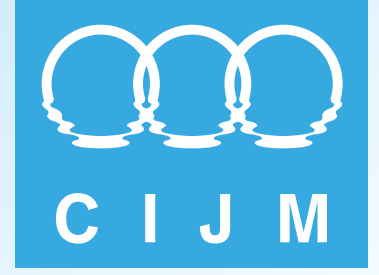

## Results Book



## Sailing



**TOSYALI  
ALGERIE**

Fer et Acier

سوناطراي



sonarach



microplus  
DATA PROCESSING & TIMING  
www.microplustiming.com





## Competition Schedule

As of FRI 1 JUL 2022

Date	Start Time	Event	
MON 27 JUN 2022	11:00	Men's IQFOIL Race 1 Race 1	
	11:10	Women's IQFOIL Race 1 Race 1	
	11:30	Men's IQFOIL Race 2 Race 2	
	11:40	Women's IQFOIL Race 2 Race 2	
	12:00	Men's IQFOIL Race 3 Race 3	
	12:10	Women's IQFOIL Race 3 Race 3	
	12:30	Men's IQFOIL Race 4 Race 4	
	12:40	Women's IQFOIL Race 4 Race 4	
	14:00	Men's Laser Race 1 Race 1	
	14:10	Women's Laser Radial Race 1 Race 1	
	15:00	Men's Laser Race 2 Race 2	
	15:10	Women's Laser Radial Race 2 Race 2	
	TUE 28 JUN 2022	11:00	Women's Laser Radial Race 3 Race 3
		11:10	Men's Laser Race 3 Race 3
12:00		Women's Laser Radial Race 4 Race 4	
12:10		Men's Laser Race 4 Race 4	
14:00		Women's IQFOIL Race 5 Race 5	
14:10		Men's IQFOIL Race 5 Race 5	
14:20		Women's IQFOIL Race 6 Race 6	
14:30		Men's IQFOIL Race 6 Race 6	
14:40		Women's IQFOIL Race 7 Race 7	
14:50		Men's IQFOIL Race 7 Race 7	
WED 29 JUN 2022	11:10	Men's IQFOIL Race 9 Race 9	
	14:00	Men's Laser Race 5 Race 5	
	14:10	Women's Laser Radial Race 5 Race 5	
	14:50	Men's Laser Race 6 Race 6	
	15:00	Women's Laser Radial Race 6 Race 6	
THU 30 JUN 2022	14:00	Women's Laser Radial Race 7 Race 7	
	14:10	Men's Laser Race 7 Race 7	
	14:20	Women's IQFOIL Race 8 Race 8	
	14:30	Men's IQFOIL Race 10 Race 10	
	14:40	Women's IQFOIL Race 9 Race 9	
	14:50	Women's Laser Radial Race 8 Race 8	
	15:00	Men's Laser Race 8 Race 8	
	15:10	Men's IQFOIL Race 11 Race 11	
	15:20	Women's IQFOIL Race 10 Race 10	
	15:30	Men's IQFOIL Race 12 Race 12	
15:40	Women's IQFOIL Race 11 Race 11		
15:50	Men's IQFOIL Race 13 Race 13		



## Competition Schedule

As of FRI 1 JUL 2022

Date	Start Time	Event
FRI 1 JUL 2022	16:00	Women's IQFOIL Race 12 Race 12
	11:00	Men's IQFOIL Race 14 Race 14
	11:10	Women's IQFOIL Race 13 Race 13
	11:20	Men's IQFOIL Race 15 Race 15
	11:30	Women's IQFOIL Race 14 Race 14
	11:40	Men's IQFOIL Race 16 Race 16
	11:50	Women's IQFOIL Race 15 Race 15
	12:00	Men's IQFOIL Race 17 Race 17
	12:10	Women's IQFOIL Race 16 Race 16
	SUN 3 JUL 2022	11:00
11:10		Women's Laser Radial Medal Race Medal Race
11:20		Women's IQFOIL Medal Race Medal Race
11:30		Men's IQFOIL Medal Race Medal Race



## Medallists by Event

As of SUN 3 JUL 2022 at 20:16

After 4 of 4 events

Event Name	Date	Medal	Name	CTRY Code
Women IQFOIL	SUN 3 JUL 2022	GOLD	NOESMOEN Helene	FRA
		SILVER	MAGGETTI Marta	ITA
		BRONZE	CARGO Palma	CRO
Women Laser Radial	SUN 3 JUL 2022	GOLD	BARRUE Marie	FRA
		SILVER	BENINI FLORIANI Chiara	ITA
		BRONZE	GUZEL Ecem	TUR
Men IQFOIL	SUN 3 JUL 2022	GOLD	RENNA Nicolo'	ITA
		SILVER	ARNOUX Tom	FRA
		BRONZE	DI TOMASSI Luca	ITA
Men Laser	SUN 3 JUL 2022	GOLD	BERNAZ Jean Baptiste	FRA
		SILVER	RODRIGUEZ PEREZ Joel	ESP
		BRONZE	COCCOLUTO GIORGETTI Giovanni	ITA



# Mediterranean Games ORAN 2022

## Sailing

### ILCA7



#### Day 7 - Provisional Result Overall

Rank	Nat	Sail Number	Name	Sailor ID	R1	R2	R3	R4	R5	R6	R7	R8	R Final	Total	Nett
1th	FRA	216112	Jean Baptiste Bernaz	FRAJB13	3	6	1	1	1	2	3	2	(29 DNC)	48	19
2th	ESP	218180	Joel Rodriguez Perez	ESPJR44	(16)_	1	3	10	2	6	1	7	5	51	35
3th	ITA	188953	Giovanni Coccoluto	ITAGC55	2	2	11	7	(12)_	1	4	4	6	49	37
4th	ITA	216159	Lorenzo Brando Chiavarini	ITALC153	1	7	4	6	10	9	(29 DSQ)	1	1	68	39
5th	SLO	214148	Zan Luka Zelko	SLOZZ2	4	3	5	(13)_	3	7	10	5	11	61	48
6th	MNE	220671	Milivoj Dukic	MNEMD1	5	8	12	11	9	4	(29 UFD)	3	2	83	54
7th	FRA	203855	Alexandre Boite	FRAAB50	9	11	7	5	11	3	2	(12)_	8	68	56
8th	POR	202211	Eduardo Marques	POREM3	12	4	10	(29 UFD)	5	8	7	13	7	95	66
9th	MNE	220640	Ilija Markovic	MNEIM1	8	10	(15)_	3	8	5	11	8	14	82	67
10th	TUR	191719	Berkay Abay	TURBA13	7	12	2	12	7	(29 BFD)	8	15	9	101	72
11th	CRO	217717	Bruno Gaspic	CROBG3	11	5	14	(20)_	18	14 (RDG)	5	6	4	97	77
12th	CRO	219759	Stipe Gaspic	CROSG	(23)_	18	9	9	15	20	14	11	3	122	99
13th	MON	217788	Jeremy Moutout	MONGM1	17	(20)_	16	4	6	10	12	18	16	119	99
14th	TUR	213512	Yigit Yalcin Citak	TURYC3	6	13	(29 RET)	8	(29 RET)	11	6	(29 RET)	10	141	112
15th	POR	217531	Santiago Sampaio	PORSS1	13	9	6	2	(29 RET)	(29 BFD)	(29 UFD)	16	12	145	116
16th	SLO	218578	Liam Orel	SLONO1	14	15	(19)_	17	14	13	15	10	19	136	117
17th	SRB	203013	Nikola Banjac	SRBNB2	15	14	13	15	(22)_	12	19	9	21	140	118
18th	EGY	211511	Aly Badawy	EGYAB3	19	17	18	16	(20)_	15	9	14	13	141	121
19th	ALG	190611	Wassim Ziani	ALGWZ1	21	16	17	14	4	16	16	19	(24)_	147	123
20th	CYP	214463	Yiasemides Georgios	CYPGY1	18	21	20	21	17	19	17	21	(23)_	177	154
21th	ALG	190625	Abdelkhalek Boussouar	ALGAB8	22	(29 BFD)	21	19	16	17	21	24	15	184	155
22th	CYP	214465	Panayiotis Iordanou	CYPPI1	20	19	23	23	(24)_	23	13	17	22	184	160
23th	GRE	215529	Dimitri Papadimitriou	GREDP19	10	(29 DSQ)	8	(29 RET)	13	18	(29 DNF)	(29 DNF)	(29 DNC)	194	165
24th	TUN	213131	Hamdi Slimani	TUNHS2	(25)_	23	22	22	21	21	18	20	18	190	165
25th	EGY	190998	Omar El-Zeiny	EGYOE3	(24)_	22	24	18	19	22	20	23	20	192	168
26th	TUN	211113	Iheb Hkiri	TUNIH3	26	24	(29 UFD)	24	23	(29 BFD)	22	22	17	216	187
27th	LBA	218191	Motaz Elhadek	LBAHA7	(29 DNF)	(29 DNF)	25	25	25	24	23	25	(29 DNC)	234	205
28th	LIB	218172	Malek Daou	LIBMD1	(29 DNF)	(29 DNF)	26	26	(29 DNC)	(29 DNC)	(29 DNC)	(29 DNC)	(29 DNC)	255	226

Report Created on 03 July 2022 at 14.30

Data Processing and Timing by Microplus - www.microplustiming.com



# Mediterranean Games ORAN 2022

## Sailing Men's IQFOIL



### Day 7 - Provisional Result Overall

Rank	Nat	Sail Number	Name	Sailor ID	R1	R2	R3	R4	SL1	SL2	SL3	SL4	SL5	SL6	SL7	SL8	R13	R14	R15	R16	R17	SL9	Total	Nett
1th	ITA	150	Nicolo' Renna	ITANR16	4	1	(5)_	3	1	5	1	3	2	1	2	1	3	1	3	3	1	3	43	38
2th	FRA	152	Tom Arnoux	FRATA	3	4	2	4	2	2	8	1	1	2	1	4	1	4	2	1	2	(21 DNF)	65	44
3th	ITA	24	Luca Di Tomassi	ITALD70	1	2	1	1	4	1	3	2	8	8	5	3	(21) DSQ	2	1	6	4	5	78	57
4th	FRA	629	Louis Pignolet	FRALP46	2	5	4	6	(21 BFD)	3	5	9	3	3	12	2	5	3	6	5	6	(21) UFD	121	100
5th	ESP	1	Angel Granda Roque	ESPAG71	(21 RET)	6	3	2	7	(21) DNF	(21) DSQ	4	7	4	6	7	2	8	4	2	3	2	130	109
6th	TUR	399	Onur Cavit Biriz	TURCB7	6	8	7	8	3	11	12	(21 DNF)	5	5	4	6	4	7	8	4	7	4	130	109
7th	ESP	4	Tomas Vieito	ESPTV1	(21 RET)	3	(21) UFD	5	8	4	2	(21) DNF	10	14	3	5	10	5	5	7	5	1	150	129
8th	POR	23	Joao Tiago Faria de Abreu	PORJF12	7	11	8	9	10	8	6	12	4	7	7	(21) UFD	6	6	7	8	8	7	152	131
9th	TUR	2094	Luis Ferdinand	TURLG2	9	10	9	10	6	9	10	10	6	6	8	10	8	9	9	(11)_	9	6	155	144
10th	CYP	17	Iakovos Christofidis	CYPIC1	12	12	10	11	(21 BFD)	7	7	5	9	10	10	9	7	11	10	13	10	8	182	161
11th	ALG	113	Ramzi Boujatit	ALGRB2	11	(15)_	12	13	11	10	9	7	12	9	9	11	12	10	11	10	11	9	192	177
12th	TUN	48	Mehdi Guembri	TUNMG2	8	9	11	12	9	12	(21 DNF)	(21) DNC	14	13	13	8	9	13	13	9	12	11	218	197
13th	ALG	112	Boudrouma Rami	ALG	13	(16)_	13	15	12	14	11	11	13	11	11	14	11	15	12	12	13	10	227	211
14th	GRE	80	Leonidas Tsortanidis	GRELT10	5	7	6	7	5	6	4	8	11	(21 DNF)	(21) DNF	(21) DNF	(21) DNF	(21) DNF	(21) DNF	(21) DNF	(21) DNF	(21) DNF	248	227
15th	EGY		Mohamed Elsafty	EGYME2	15	14	(21 DNF)	17	13	13	14	(21) DNF	17	12	14	13	13	14	15	15	14	(21) DNF	276	255
16th	TUN	1	Miras Samouda	TUNMS4	16	18	(21 DNF)	(21) DNF	14	15	13	6	15	15	15	15	14	16	14	14	15	(21) DNF	278	257
17th	MLT	72	Karl Miggiani	MLTKM1	10	13	14	14	16	(21 DNF)	(21) DNF	(21) DNF	(21) DNF	(21) DNF	16	12	(21) DNF	12	(21) DNF	(21) DNF	16	(21) DNF	312	291
18th	EGY	7	Mohanad Ismail	EGYMI1	14	17	15	16	15	16	15	13	16	(21 DNF)	(21) DNF	(21) DNF	(21) DNF	(21) DNF	(21) DNF	(21) DNF	(21) DNF	(21) DNF	326	305
19th	CYP	1	Andreas Cariolou	CYPAC1	(21 DNF)	(21) DNF	(21) DNF	(21) DNF	(21) DNF	(21) DNF	(21) DNF	(21) DNF	(21) DNF	(21) DNF	(21) DNF	(21) DNF	(21) DNF	(21) DNF	(21) DNF	(21) DNF	(21) DNF	(21) DNF	378	357
19th	LBA	-	Asheni Mohammed	-	(21 DNF)	(21) DNF	(21) DNF	(21) DNF	(21) DNF	(21) DNF	(21) DNF	(21) DNF	(21) DNF	(21) DNF	(21) DNF	(21) DNF	(21) DNF	(21) DNF	(21) DNF	(21) DNF	(21) DNF	(21) DNF	378	357

Report Created on 03 July 2022 at 15:14

Data Processing and Timing by Microplus - www.microplustiming.com





# Mediterranean Games ORAN 2022

## Sailing

### ILCA6



#### Day 7 - Provisional Result Overall

Rank	Nat	Sail Number	Name	Sailor ID	R1	R2	R3	R4	R5	R6	R7	R8	R Final	Total	Nett
1th	FRA	221001	Marie Barrue	FRAMB65	1	3	2	1	6	1	9	(14)_	2	39	25
2th	ITA	219811	Chiara Benini Floriani	ITALCB88	3	6	1	3	(15)_	4	7	1	5	45	30
3th	TUR	219853	Ecem Guzel	TUREG2	2	2	(13)_	8	2	2	4	6	7	46	33
4th	FRA	211861	Permelle Michon	FRAPM12	5	5	5	4	3	7	5	(8)_	1	43	35
5th	TUR	215494	Nazli Cagla Donertas	TURCD5	4	4	12	5	4	3	2	(25 UFD)	6	65	40
6th	CYP	213624	Marilena Makri	CYPM3	6	1	3	10	5	(12)_	3	3	11	54	42
7th	ESP	221160	Ana Moncado Sanchez	ESPAM89	7	9	(18)_	2	1	10	14	4	8	73	55
8th	CRO	211950	Elena Vorobeva	CROEV1	9	7	6	9	(10)_	6	1	9	9	66	56
9th	SLO	220711	Lin Pletikos	SLOP2	8	13	4	(15)_	14	8	10	2	3	77	62
10th	ITA	220478	Giorgia Della Valle	ITAGD143	10	10	8	6	7	11	6	5	(20)_	83	63
11th	ESP	216104	Cristina Pujol Bajo	ESPCP17	(25 BFD)	8	9	(25) RET	8	9	8	7	10	109	84
12th	POR	175087	Leonor Dutra	PORLD4	18	17	7	11	11	5	(20)_	13	4	106	86
13th	GRE	218104	Vlachou Maria	GREMV1	11	12	15	7	17	(19)_	15	10	16	122	103
14th	EGY	220798	Khouloud Mansy	EGYKM1	13	11	11	17	12	(18)_	13	12	14	121	103
15th	SRB	212243	Kristina BoJa	SRBKB1	16	14	14	16	9	14	11	(17)_	17	128	111
16th	POR	218912	Luisa Passos Peres	PORPP8	12	15	19	12	16	17	12	11	(21)_	135	114
17th	ALG	214351	Karassane Mallia	ALGMV5	15	16	10	13	18	16	(19)_	16	12	135	116
18th	ALG	214361	Abdelfettah Maissa	ALGMA7	17	(20)_	17	14	13	13	18	20	13	145	125
19th	MLT	217319	Lacey Aquilina	MLTLA1	14	18	20	21	20	(23)_	17	15	19	167	144
20th	EGY	221188	Dina Ramadan	EGYDR1	22	22	16	18	(25 DSQ)	15	22	23	15	178	153
21th	MLT	181315	Michela Mifsud	MLTMM5	19	(23)_	22	20	19	21	16	18	18	176	153
22th	CYP	211881	Maria Christina Michail	CYPM4	21	19	(23)_	19	21	20	21	19	23	186	163
23th	TUN	181625	Sarra Guezguez	TUNSG1	20	21	21	22	22	22	(24)_	21	24	197	173
24th	TUN	180302	Dardouri Malek	TUNDM	23	24	24	(25 DSQ)	23	24	23	22	22	210	185

Report Created on 03 July 2022 at 13.40

Data Processing and Timing by Microplus - [www.microplustiming.com](http://www.microplustiming.com)



# Mediterranean Games ORAN 2022

## Sailing Women's IQFOIL



### Day 7 - Provisional Result Overall

Rank	Nat	Sail Number	Name	Sailor ID	R1	R2	R3	R4	SL1	SL2	SL3	SL4	SL5	SL6	SL7	SL8	R13	R14	R15	R16	SL9	Total	Nett
1th	FRA	57	Helen Noesmoen	FRAHN2	1	2	1	4	6	2	5	(15 DNF)	5	1	3	1	6	1	1	1	6	61	46
2th	ITA	157	Marta Maggetti	ITAMM249	2	3	3	2	7	1	7	1	2	2	1	2	(10)_	3	6	2	3	57	47
3th	CRO	991	Palma Cargo	CROPC4	3	6	4	5	3	(8)_	3	2	4	7	5	5	2	2	4	3	8	74	66
4th	ESP	12	Pilar Lamadrid Trueva	ESPPL14	4	1	2	1	9	3	1	(15 UFD)	1	3	2	11	5	10	8	8	4	88	73
5th	FRA	712	Manon Pianazza	FRAMP64	(15 DNF)	4	7	3	2	6	6	(15) UFD	3	5	4	3	3	5	2	4	1	88	73
6th	ESP	345	Andrea Torres Fullana	ESPAF46	5	9	5	6	4	4	4	5	7	6	(12)_	7	4	8	3	5	2	96	84
7th	ITA	1	Giorgia Speciale	ITAGS131	10	5	10	8	1	5	2	3	6	4	7	6	1	4	(15 DSQ)	(15) UFD	5	107	92
8th	TUR	577	Merve Vatan	TURMV1	9	12	8	7	11	11	8	7	(15 UFD)	8	6	4	9	6	5	6	11	143	128
9th	GRE	137	Danae Pontifex	GREDP28	11	11	6	11	5	(12)_	11	6	9	10	8	9	8	12	7	7	9	152	140
10th	TUR	191	Dilara Uralp	TURDU3	8	8	11	9	8	10	10	4	(15 UFD)	11	10	8	11	9	11	9	7	159	144
11th	CYP	1	Natasa Lappa	CYPNL2	7	7	9	12	10	9	12	(15 UFD)	8	9	11	10	7	7	9	11	(15) DNF	168	153
12th	SLO	51	Lina Erzen	SLOLE1	6	10	12	10	(15DNC)	7	9	(15) DSC	(15) UFD	12	9	12	12	11	10	10	10	185	170
13th	ALG	111	Berrichi Nadjet Amina	ALGAB10	12	13	13	13	12	13	13	(15) DNF	10	13	13	13	13	13	(15) DNF	12	(15) DNF	221	206
14th	ALG	110	Katia Belabbas	ALGKB2	(15 DNF)	14	(15) DNF	(15) DNF	13	14	14	(15) DNF	(15) DNF	14	14	14	14	14	(15) DNF	13	(15) DNF	243	228

Report Created on 03 july 2022 at 15.30

Data Processing and Timing by Microplus - [www.microplustiming.com](http://www.microplustiming.com)



## Number of Entries by Country

As of WED 29 JUN 2022

Code	Country	Entries by Event				Number of Athletes		
		LAS	IQ	LR	IQ	Men	Women	Total
ALG	Algeria	2	2	2	2	4	4	8
CRO	Croatia	2		1	1	2	2	4
CYP	Cyprus	2	2	2	1	4	3	7
EGY	Egypt	2	2	2		4	2	6
ESP	Spain	1	2	2	2	3	4	7
FRA	France	2	2	2	2	4	4	8
GRE	Greece	1	1	1	1	2	2	4
ITA	Italy	2	2	2	2	4	4	8
LBA	Libya	1	1			2	0	2
LBN	Lebanon	1				1	0	1
MLT	Malta		1	2		1	2	3
MNE	Montenegro	2				2	0	2
MON	Monaco	1				1	0	1
POR	Portugal	2	1	2		3	2	5
SLO	Slovenia	2		1	1	2	2	4
SRB	Serbia	1		1		1	1	2
TUN	Tunisia	2	2	2		4	2	6
TUR	Turkey	2	2	2	2	4	4	8
	Total: 18	28	20	24	14	48	38	86

### LEGEND

F Women

M Men

-





ألعاب البحر الأبيض المتوسط  
MEDITERRANEAN GAMES  
JEUX MÉDITERRANÉENS  
du 25 juin au 06 juillet

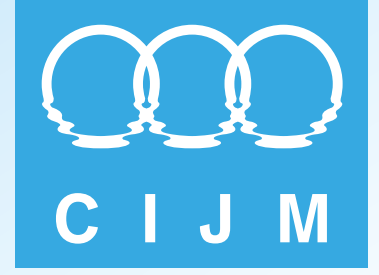

# Results Book



## Shooting



**TOSYALI  
ALGERIE**

Fer et Acier

سوناطراي



sonarach



microplus  
DATA PROCESSING & TIMING  
[www.microplustiming.com](http://www.microplustiming.com)



# Index

Results Certification Letter  
ISSF Technical Delegates and Juries  
Competition Officials  
Competition Schedule  
Entry List by Number  
Medalists by Event  
Medal Standings  
Records Broken / Equaled  
Results



This certifies that the Mediterranean Games held from 25 - 5. June 2022 in Oran, Algeria, was conducted in accordance with the ISSF and MG Rules and Regulations and the results' produced in the competitions are true and correct.

### ISSF Technical Delegates

#### Rifle/Pistol

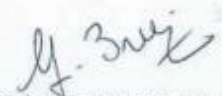
  
Ghislaine BRIEZ, FRA

#### Shotgun

  
Mohamed WAHDAN, EGY

### Chairman of the Juries

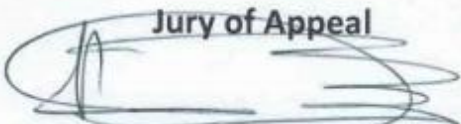
  
Alexandros DIMAKAKOS, GRE

### Rifle & Equipment Control Jury

  
Georgios PAPAPANAGIOTOU, GRE

#### Rifle Jury

  
Biserka VRBEK, CRO

#### Pistol Jury

  
Tarek SHARARA, EGY

#### RTS Jury

  
Nikola MARIC, SRB

#### Shotgun Jury

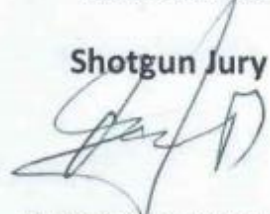
  
Panagiotis THEMILIDIS, GRE



## ISSF TECHNICAL DELEGATES AND JURIES

### ISSF Technical Delegates:

Rifle/Pistol: Ghislaine Briez (FRA)

Shotgun : Mohamed Wahdan (EGY)

Jury	Nat	Name	Gen	License	
<b>Appeal</b>	<b>GRE</b>	<b>Alexandros Dimakakos</b>	<b>M</b>	<b>A 1814</b>	<b>Chairman</b>
Appeal	FRA	Ghislaine Briez	W	A2529	Member
Appeal	EGY	Mohamed Wahdan	M	A 4444	Member
<b>Rifle</b>	<b>CRO</b>	<b>Biserka Vrbek</b>	<b>W</b>	<b>A 3761</b>	<b>Chairman</b>
Rifle	SLO	Robert Ferencak	M	A 5156	Member
<b>Pistol</b>	<b>EGY</b>	<b>Tarek Sharara</b>	<b>M</b>	<b>A 5993</b>	<b>Chairman</b>
Pistol	ESP	Maria Dolores Molini	W	B 6341	Member
<b>RTS</b>	<b>SRB</b>	<b>Nikola Maric</b>	<b>M</b>	<b>A 4992</b>	<b>Chairman</b>
RTS	ITA	Maurizio Calzolari	M	A 5235	Member
<b>Equip C</b>	<b>GRE</b>	<b>Georgios Papapanagiotou</b>	<b>M</b>	<b>A 4099</b>	<b>Chairman</b>
<b>Shotgun</b>	<b>GRE</b>	<b>Panagiotis Themelidis</b>	<b>M</b>	<b>A 4063</b>	<b>Chairman</b>
Shotgun	ALG	Aitelhadj Abdelmalek	M	A 4468	Member
Shotgun	TUN	Khaled Khalfellaoui	M	A 4217	Member



## COMPETITION OFFICIALS

Function	Name, Nat
Competition Director Coordinator	Ahmed Abdallah, ALG
10m Shooting Range Chief Range Officer	Amina Hamdani, ALG
Range Officer	Mohamed Kerboub, ALG
Range Officer	Djamel Mezenner, ALG
Range Officer	Hocine Terrab, ALG
Equipment Control Chief Equipment Control Officer	Jean Marc Blaising, FRA
Finals Shooting Range Chief Range Officer	Jean Louis Gayaudon, FRA
Announcer	Robert Ferencak, SLO
Chief of RTS Office	Islam Ahmad Abdelmoteleb, EGY



## Shotgun Referee

### Chief Range officer

Referee  
Referee  
Referee  
Referee  
Referee  
Referee  
Referee  
Referee  
Referee  
Referee  
Referee  
Referee  
Referee  
Referee  
Referee  
Referee

### Yiannis Heracleus, CYP

Pierre Bourgeois, FRA  
Johanna Spartacus, FRA  
Christophe Bouche, FRA  
Selim Ashraf, EGY  
Eftychios Loizou, CYP  
Lorena Garofalo, ITA  
Andrea Dupre DeForesta, ITA  
Amar Abdesamad, ALG  
Laissaoui Adjimi, ALG  
Mohamed Bensaad, ALG  
Nourredine Bensidi, ALG  
Abdelmalek Madas, ALG  
Nacer Salah Belkhoudja, ALG  
Wahiba Tekfi, ALG  
Areslal Izem, ALG  
Mohamed Malki, ALG



## Competition Schedule

Jour	Position Tir	Début compé	Fin de compé	Evènement	SEXE	ETAPES	Mise en place	FINAL	PRIX
<b>27.06.2022</b>		12 :30	13 :00	Meeting Technique					
28.06.2022		09:00	15:00	Contrôle des équipements					
		09:00	15:00	Skeet Jour 1 (75 cibles )	H/F	Qualification			
		10 :00	10 :30	Pistolet à Air Équipe Mixte	H/F	Pre Event Training			
		11:00	12:30	Entrainement non officiel Pistolet à Air	H/F				
29.06.2022		13:30	15:00	Entrainement non officiel Carabine	H/F				
		09:00	16:00	Contrôle des équipements					
		09:00	12:00	Skeet Jour 2 (50 Cibles)	H/F	Qualification			
				Skeet	F	Finale	13:00	13 :30	16:30
				Skeet	H	Finale	14:45	15:15	16:30
	09:05	09:15	09:45	Pistolet à Air Équipe Mixte	H/F	Qualification			
30.06.2022		11:00	12:00	Pistolet à Air Équipe Mixte	H/F	Finale	11 :00	11 :30	12:30
				Carabine à Air	H	Pre Event Training			
		09:00	16:00	Contrôle des équipements					
	09:00	09:15	10:30	Carabine à Air	H	Qualification			
				Carabine à Air	H	Finale	11 :00	11 :30	12 :15
		09:00	11:30	Skeet Equipe Mixte	H/F	Qualification			
1.07.2022				Skeet Équipe Mixte	H/F	Finale	13:00	13 :30	15:00
		11:30	12:30	Pistolet à Air	M	Pre Event Training			
		14 :00	15 :00	Carabine à Air	F	Pre Event Training			
		09:00	15:00	Contrôle des équipements					
	09:00	09:15	10:30	Carabine à air	F	Qualification			
				Carabine à air	F	Finale	11 :00	11 :30	12 :15
2.07.2022	11 :45	12 :00	13 :15	Pistolet à Air	H	Qualification			
				Pistolet à Air	H	Finale	14 :00	14 :30	15 :15
		09 :00	12 :00	Trap	H/F	Pre Event Training			
		14 :00	15 :00	Pistolet à Air	F	Pre Event Training			
		15 :30	16 :00	Carabine à Air Équipe Mixte	H/F	Pre Event Training			
		09:00	15:00	Contrôle des équipements					
3.07.2022		09:00	15:00	Trap Jour 1 (75 Cibles)	H/F	Qualification			
	09:00	09:15	10:30	Pistolet à Air	F	Qualification			
				Pistolet à Air	F	Finale	11 :00	11 :30	12 :15
	10 :50	11 :00	11 :30	Carabine à air Equipe Mixte	H/F	Qualification			
			Carabine à air Equipe Mixte	H/F	Finale	12 :00	12 :30	13 :15	
3.07.2022		09 :00	15 :30	Contrôle des équipements					
		09:00	12:00	Trap Jour 2 (50 Cibles)	H/F	Qualification			
				Trap	F	Finale	13:00	13 :30	16 :30
			Trap	H	Finale	14 :45	15 :15	16 :30	



## Entry List by Number

Country	Entries by Event											Number of Athletes		
	Men				Women				Mixed			Men	Women	Total
	10P	10R	SKT	TRP	10P	10R	SKT	TRP	10P	10R	SKT			
ALB					1	1						0	2	2
ALG	2	2	2	2	2	2		2	2	1		8	6	14
BIH	1	2		2		2				2		5	2	7
CRO		2		2		2				2		4	2	6
CYP		2	2	2	2	1	2	2		1	2	6	7	13
EGY			2	2				2				4	2	6
ESP	1	2		2	1	2		2	1	2		5	5	10
FRA	1	2	2	2	2	2	2	2	1	2	2	7	8	15
GRE	1		2	1	1		1		1		1	4	2	6
ITA	2	2	2	2	2	2	2	2	2	2	2	8	8	16
KOS	1	1										2	0	2
LBA	2											2	0	2
MAR				2			1	1				2	2	4
MKD	1					1						1	1	2
MLT			2	2	1							4	1	5
POR	2			2	1	1		2	1			4	4	8
SLO	1	2		2	2	2			1	2		5	4	9
SMR				1				1				1	1	2
SRB	1	2			1	2			1	2		3	3	6
TUN	1	1	2	2	2	1			1	1		6	3	9
TUR	2	2	2	2	2	2	2	2	2	2	2	8	8	16
Total: 21	19	22	18	30	20	23	10	18	13	19	9	89	71	160





## Medallists by Event

REVISED  
SUN 3 JUL 22:39

As of SUN 3 JUL 2022 at 22:39

After 11 of 11 events

Event Name	Date	Medal	Name	CTRY Code
Women Skeet	WED 29 JUN 2022	GOLD	BARTOLOMEI Martina	ITA
		SILVER	KATZOURAKI Emmanouela	GRE
		BRONZE	BACOSI Diana	ITA
Men Skeet	WED 29 JUN 2022	GOLD	NIKOLAIDIS Stefanos	CYP
		SILVER	MITAS Efthymios	GRE
		BRONZE	MEHELBA Azmy	EGY
Mixed 10m Air Pistol	WED 29 JUN 2022	GOLD	ARUNOVIC Zorana MIKEC Damir	SRB SRB
		SILVER	FOUQUET Florian Laurent JEDRZEJEWSKI Camille Claire	FRA FRA
		BRONZE	GIANCAMILI Chiara TESCONI Luca	ITA ITA
Men 10m Air Rifle	THU 30 JUN 2022	GOLD	SEBIC Milenko	SRB
		SILVER	MARICIC Miran	CRO
		BRONZE	LUKIC Luka	SLO
Mixed Skeet	THU 30 JUN 2022	GOLD	BATTAULT Noémie Agnès PETIT Emmanuel Stéphane	FRA FRA
		SILVER	BACOSI Diana CASSANDRO Tamaro	ITA ITA
		BRONZE	BARTOLOMEI Martina ROSSETTI Gabriele	ITA ITA
Women 10m Air Rifle	FRI 1 JUL 2022	GOLD	MULLER Océanne Marianne	FRA
		SILVER	VUKOJEVIC Teodora	SRB
		BRONZE	DVORSAK Ziva	SLO
Men 10m Air Pistol	FRI 1 JUL 2022	GOLD	MIKEC Damir	SRB
		SILVER	KELES Ismail	TUR
		BRONZE	TESCONI Luca	ITA
Women 10m Air Pistol	SAT 2 JUL 2022	GOLD	KORAKAKI Anna	GRE
		SILVER	JEDRZEJEWSKI Camille Claire	FRA
		BRONZE	ARUNOVIC Zorana	SRB
Mixed 10m Air Rifle	SAT 2 JUL 2022	GOLD	BAUDOUIN Brian Richard MULLER Océanne Marianne	FRA FRA
		SILVER	ARSOVIC Andrea KOVACEVIC Lazar	SRB SRB
		BRONZE	DVORSAK Ziva LUKIC Luka	SLO SLO
Women Trap	SUN 3 JUL 2022	GOLD	CORMENIER Carole, Marie	FRA
		SILVER	COELHO DE BARROS Maria Ines	POR
		BRONZE	STANCO Silvana Maria	ITA
Men Trap	SUN 3 JUL 2022	GOLD	TUZUN Oguzhan	TUR
		SILVER	GLASNOVIC Anton	CRO
		BRONZE	BERTI Gian Marco	SMR



## Medal Standings

Rank	Country	Men				Women				Mixed				Total				Rank by total
		G	S	B	Tot	G	S	B	Tot	G	S	B	Tot	G	S	B	Tot	
1	FRA - France					2	1		3	2	1		3	4	2		6	= 2
2	SRB - Serbia	2			2		1	1	2	1	1		2	3	2	1	6	= 2
3	GRE - Greece		1		1	1	1		2					1	2		3	= 4
4	ITA - Italy			1	1	1		2	3		1	2	3	1	1	5	7	1
5	TUR - Turkey	1	1		2									1	1		2	= 6
6	CYP - Cyprus	1			1									1			1	= 8
7	CRO - Croatia		2		2									2			2	= 6
8	POR - Portugal						1		1					1			1	= 8
9	SLO - Slovenia			1	1			1	1			1	1			3	3	= 4
10	EGY - Egypt			1	1											1	1	= 8
10	SMR - San Marino			1	1											1	1	= 8
<b>Total:</b>		<b>4</b>	<b>4</b>	<b>4</b>	<b>12</b>	<b>4</b>	<b>4</b>	<b>4</b>	<b>12</b>	<b>3</b>	<b>3</b>	<b>3</b>	<b>9</b>	<b>11</b>	<b>11</b>	<b>11</b>	<b>33</b>	

## MEDITERRANEAN GAMES RECORDS BROKEN/EQUALED

MEDITERRANEAN GAMES RECORDS					
Event	Phase	Old / New	Name	Nat	Date
10m Air Rifle Men	Qual.	628,9/632,4	KOVACEVIC Lazar	SRB	30.06.2022
10m Air Rifle Women	Qual.	627,9/630,6	GRANDE MARTINEZ Paula	ESP	01.07.2022
10m Air Pistol Women	Qual.	575/588	KORAKAKI Anna	GRE	02.07.2022
Trap Women	Qual.	119/119	COELHO DE BARROS Maria Ines	POR	03.07.2022
Skeet Women	Qual.	-/120	KATZOURAKI Emmanouela	GRE	29.06.2022
			BACOSI Diana	ITA	
			ANASTASSIOU Lucie	FRA	

As of 3<sup>rd</sup> JULY 2022

MEDITERRANEAN GAMES RECORDS TEAM					
Event	Phase	Old / New	Name	Nat	Date
10m Rifle Mixed Team	Qual.	-/632,6	MULLER Océanne BAUDOIN Brian	FRA	02.07.2022
10m Pistol Mixed Team	Qual.	-/576	MIKEC Damir ARUNOVIC Zorana	SRB	29.06.2022
Skeet Mixed Team	Qual.	-/146	PETIT Emmanuel BATAULT Noemie	FRA	01.07.2022
			CASSANDRO Tammaro BACOSI Diana	ITA	



# RESULTS

## 10M AIR RIFLE MEN

### MEDAL MATCH

THU 30 JUN 2022, START TIME 11:30

Rk	Bib No	Name	Nat	1	2	3	4	5	6	7	8	9	10	11	12	13	14	15	16	Tot.	Remarks
1	176	SEBIC Milenko	SRB	0	2	0	0	2	2	2	2	0	2	0	2	0	0	1	2	17.0	<b>GOLD</b>
2	160	MARICIC Miran	CRO	2	0	2	2	0	0	0	0	2	0	2	0	2	2	1	0	15.0	<b>SILVER</b>

Legend:

Rk Rank  
Tot. Total  
Bib No Bib Number  
Nat Nation



## FINAL RESULTS 10M AIR RIFLE MEN RANKING MATCH

THU 30 JUN 2022, START TIME 11:30

Rk	Bib No	Name	Nat	Ser 1	Ser 2	Ser 3	Ser 4	Ser 5	Total	Remarks
1	160	MARICIC Miran	CRO	51.6	52.1	51.5	53.1	51.4	<b>259.7</b>	GMM
2	176	SEBIC Milenko	SRB	52.3	51.4	52.3	51.6	51.7	<b>259.3</b>	GMM
3	158	LUKIC Luka	SLO	51.6	51.0	52.2	51.8	52.4	<b>259.0</b>	BR
4	110	BAUDOUIN Brian	FRA	51.9	51.6	52.3	51.9	50.8	<b>258.5</b>	
5	157	KOVACEVIC Lazar	SRB	51.7	50.6	51.2	52.3		<b>205.8</b>	
6	173	RAYNAUD Alexis	FRA	51.5	50.7	51.8	51.3		<b>205.3</b>	
7	103	AKGUN Omer	TUR	51.7	50.3	51.0			<b>153.0</b>	
8	170	PETANJEK Borna	CRO	50.4	50.5	51.9			<b>152.8</b>	

REVISED

Legend:

Rk	Rank	Bib No	Bib Number	Nat	Nation
Ser	Series	GMM	Gold Medal Match	BR	



# RESULTS

## 10M AIR RIFLE MEN

### QUALIFICATION

THU 30 JUN 2022, START TIME 09:15

Records

QMGR	628.9	MONNIER, Jeremy	FRA	24 JUN 2013	MED Games	Mersin (TUR)
------	-------	-----------------	-----	-------------	-----------	--------------

Rk	Bib No	Name	Nat	Series						Total	Remarks
				1	2	3	4	5	6		
1	157	KOVACEVIC Lazar	SRB	105.4	106.4	106.2	105.3	105.1	104.0	632.4	QF,QMGR
2	160	MARICIC Miran	CRO	104.7	104.1	104.7	105.6	104.5	104.8	628.4	QF
3	158	LUKIC Luka	SLO	106.4	104.2	104.8	103.9	103.1	105.6	628.0	QF
4	110	BAUDOUIN Brian	FRA	101.5	105.2	105.3	104.8	103.5	105.6	625.9	QF
5	103	AKGUN Omer	TUR	105.9	103.4	105.1	103.3	103.9	104.1	625.7	QF
6	170	PETANJEK Borna	CRO	104.7	102.6	105.5	105.3	104.4	103.1	625.6	QF
7	176	SEBIC Milenko	SRB	103.8	104.3	103.6	104.7	104.9	103.7	625.0	QF
8	173	RAYNAUD Alexis	FRA	102.8	105.3	104.2	103.6	104.6	104.3	624.8	QF
9	169	OVIEDO BERENQUER Jesus	ESP	103.6	103.8	105.0	104.7	104.0	103.6	624.7	
10	142	GONZALEZ BOCERO Adrian	ESP	103.6	103.2	103.9	105.2	103.8	104.3	624.0	
11	113	BERNARDI Michele	ITA	103.1	103.2	103.1	104.9	103.8	105.6	623.7	
12	121	CAPANO Giuseppe Pio	ITA	103.5	103.4	104.3	103.6	105.5	103.1	623.4	
13	134	DZANKOVIC Nedzad	BIH	103.8	103.3	102.5	103.3	103.7	104.4	621.0	
14	177	SOCIC Jure	SLO	103.8	104.4	101.9	103.1	103.7	102.6	619.5	
15	151	KARABINA Yusuf	TUR	100.8	102.4	103.0	102.2	104.4	104.9	617.7	
16	125	CHARALAMBOUS Andreas	CYP	103.3	102.0	103.7	103.6	101.4	103.2	617.2	
17	172	RASIC Matej	BIH	103.6	102.7	102.4	101.8	102.2	104.1	616.8	
18	109	AZIZI Alaa Eddine	TUN	103.2	101.9	103.5	102.0	102.5	102.3	615.4	
19	112	BENZIDANE Reda	ALG	100.6	101.7	100.3	103.1	102.5	103.4	611.6	
20	102	ADOUL Kouceila	ALG	101.3	99.4	102.1	100.9	102.7	102.5	608.9	
21	147	IBRAHIMI Drilon	KOS	99.3	98.4	102.7	101.4	102.0	101.6	605.4	
22	135	EVANGELOU Georgios	CYP	98.6	99.3	101.4	100.0	103.1	102.4	604.8	

Summary:

Number of athletes on this list: 22; Total number of athletes: 22

Legend:

QMGR	Qualification Mediterranean Games Record	Rk	Rank	Bib No	Bib Number
Nat	Nation	QF	Qualified for Final		



**RESULTS**  
**10M AIR PISTOL MEN**  
**MEDAL MATCH**  
 FRI 01 JUL 2022, START TIME 14:30

Rk	Bib No	Name	Nat	1	2	3	4	5	6	7	8	9	10	11	12	13	14	15	16	Tot.	Remarks	
1	164	MIKEC Damir	SRB	0	0	2	2	2	2	0	0	2	2	2	2						16.0	<b>GOLD</b>
2	152	KELES Ismail	TUR	2	2	0	0	0	0	2	2	0	0	0	0						8.0	<b>SILVER</b>

Legend:

Rk	Rank	Bib No	Bib Number	Nat	Nation
Tot.	Total				



# RESULTS

## 10M AIR PISTOL MEN

### RANKING MATCH

FRI 01 JUL 2022, START TIME 14:30

Rk	Bib No	Name	Nat	Ser 1	Ser 2	Ser 3	Ser 4	Ser 5	Total	Remarks
1	152	KELES Ismail	TUR	51.3	48.8	50.3	50.3	48.8	<b>249.5</b>	GMM
2	164	MIKEC Damir	SRB	50.9	47.8	50.5	48.8	51.0	<b>249.0</b>	GMM
3	179	TESCONI Luca	ITA	49.4	51.0	48.6	49.5	48.9	<b>247.4</b>	BR
4	159	MALDINI Federico Nilo	ITA	49.0	49.3	50.4	49.1	49.5	<b>247.3</b>	
5	136	FOUQUET Florian	FRA	50.8	51.2	47.5	47.2		<b>196.7</b>	
6	123	CEPER Joze	SLO	46.9	50.0	49.8	49.8		<b>196.5</b>	
7	150	JOVICIC Nikola	BIH	47.1	49.4	49.3			<b>145.8</b>	
8	131	DIKEC Yusuf	TUR	47.5	49.4	48.5			<b>145.4</b>	

Legend:

Rk	Rank	Bib No	Bib Number	Nat	Nation
Ser	Series	GMM	Gold Medal Match	BR	Bronze





## RESULTS

### 10M AIR PISTOL MEN

#### QUALIFICATION

FRI 01 JUL 2022, START TIME 12:00

Records

QMGR	588	BRUNO, Francesco	ITA	28 JUN 2005	MED Games	Almeria (ESP)
------	-----	------------------	-----	-------------	-----------	---------------

Rk	Bib No	Name	Nat	Series						Total	Remarks
				1	2	3	4	5	6		
1	164	MIKEC Damir	SRB	99	98	97	98	99	94	<b>585-29x</b>	QF
2	136	FOUQUET Florian	FRA	97	96	99	96	96	94	<b>578-20x</b>	QF
3	152	KELES Ismail	TUR	97	96	98	93	96	96	<b>576-15x</b>	QF
4	159	MALDINI Federico Nilo	ITA	97	97	97	94	93	97	<b>575-17x</b>	QF
5	123	CEPER Joze	SLO	93	94	96	95	98	99	<b>575-16x</b>	QF
6	179	TESCONI Luca	ITA	95	95	96	97	95	97	<b>575-15x</b>	QF
7	131	DIKEC Yusuf	TUR	97	97	95	92	99	93	<b>573-13x</b>	QF
8	150	JOVICIC Nikola	BIH	93	97	94	97	95	96	<b>572-15x</b>	QF
9	120	CALVETE PEREIRA DA COSTA João	POR	94	94	95	96	96	97	<b>572-11x</b>	
10	171	RAMINHAS CARAPINHA Tiago Miguel	POR	96	93	96	95	90	96	<b>566-13x</b>	
11	156	KORAKAKIS Dionysios	GRE	94	94	94	96	94	94	<b>566-9x</b>	
12	174	SAHITI Nexhat	KOS	91	95	97	94	94	93	<b>564-15x</b>	
13	101	ADJABI Amine	ALG	94	92	95	92	95	95	<b>563-16x</b>	
14	119	BRANKOVSKI Borjan	MKD	94	94	96	94	95	90	<b>563-11x</b>	
15	168	OTHMANI Alaa	TUN	91	97	95	92	94	93	<b>562-11x</b>	
16	115	BIN DALLAH Mohammed	LBA	96	91	89	93	92	92	<b>553-9x</b>	
17	163	MEHALI Tayeb	ALG	87	90	89	92	96	93	<b>547-14x</b>	
18	104	ALAEWAR Abulsamia	LBA	93	84	89	93	93	91	<b>543-6x</b>	
	138	FREIJE TORNEIRO Martin	ESP								DNS

#### Summary:

Number of athletes on this list: 19; Total number of athletes: 19































#### Legend:

QMGR	Qualification Mediterranean Games Record	Rk	Rank	Bib No	Bib Number
Nat	Nation	QF	Qualified for Final	DNS	Did not Start

## TR125

### Classification: Men - TRAP



















Page 1 of 1

Pos.	Name	Bib	NOC	Cat	R1	R2	R3	R4	R5	Qua	Semi-Final	Final
1	TUZUN, Oguzhan	1048	TUR 	M	25	24	24	24	24	121+0	19	29 <b>GOLD</b>
2	GLASNOVIC, Anton	1023	CRO 	M	24	25	25	25	24	123	24	28 <b>SILVER</b>
3	BERTI, Gian Marco	1044	SMR 	M	24	23	24	23	24	118	20	19 <b>BRONZE</b>
4	DE FILIPPIS, Mauro	1034	ITA 	M	24	24	24	25	23	120+4	21	11
5	ZAHER, Ahmed	1028	EGY 	M	24	24	25	24	24	121+1	20	
6	VATOVEC, Denis	1043	SLO 	M	24	23	25	24	24	120+3	18	
7	MARTINEZ TORRES, Adria	1030	ESP 	M	23	24	24	23	25	119	12	
8	TUNCER, Nedim Tolga	1047	TUR 	M	25	22	25	25	25	122	9	
9	RESCA, Daniele	1035	ITA 	M	24	21	23	24	25	117		
10	MEHELBA, Abdelaziz	1027	EGY 	M	23	24	24	25	21	117		
11	MAKRI, Andreas	1026	CYP 	M	22	23	24	22	25	116		
12	MACEK, Bostjan	1042	SLO 	M	23	23	25	22	23	116		
13	GLASNOVIC, Josip	1024	CRO 	M	23	23	23	23	23	115		
14	AKTERZI, Nihat	1025	CYP 	M	23	24	22	23	23	115		
15	BRUNO FARIA, Jose Manuel	1040	POR 	M	24	21	25	23	22	115		
16	DESERT, Antonin	1031	FRA 	M	22	24	23	21	24	114		
17	AQUILINA, Jason John	1038	MLT 	M	23	21	24	23	23	114		
18	MATIAS DE AZEVEDO, Joao Paulo	1041	POR 	M	22	23	24	24	21	114		
19	GUERRERO, Sebastien	1032	FRA 	M	23	23	24	24	20	114		
20	CHETCUTI, William	1039	MLT 	M	21	23	20	25	24	113		
21	HAFFARI, Driss	1037	MAR 	M	23	24	22	22	22	113		
22	ALHRRAS, Zouhair	1036	MAR 	M	21	23	23	20	25	112		
23	CHATZITSAKIROGLOU, Ioannis	1033	GRE 	M	22	22	21	22	24	111		
24	BOUALI, Salah Eddine	1020	ALG 	M	21	22	24	24	20	111		
25	ELLOUMI, Zied	1045	TUN 	M	22	23	22	21	22	110		
26	ABID, Fouad	1019	ALG 	M	23	21	23	22	21	110		
27	SIMIC, Mladen	1021	BIH 	M	17	21	23	21	21	103		
28	STJEPANOVIC, Miladin	1022	BIH 	M	18	18	21	22	21	100		
29	YAACOUBI, Adel	1046	TUN 	M	19	19	20	0	0	58		DNF
30	FERNANDEZ MUNOZ, Alberto	1029	ESP 	M	0	0	0	0	0	0		DNS

## SK125

### Classification: Men - SKEET

Page 1 of 1

Pos.	Name	Bib	NOC	Cat	R1	R2	R3	R4	R5	Qua	Semi-Final	Final
1	NIKOLAIDIS, Stefanos	1003	CYP 	M	24	23	25	23	25	120+7	28	35+4 <b>GOLD</b>
2	MITAS, Efthymios	1010	GRE 	M	24	24	22	25	24	119+16	27	35+3 <b>SILVER</b>
3	MEHELBA, Azmy	1005	EGY 	M	24	24	25	25	25	123	26	26 <b>BRONZE</b>
4	CHALKIADAKIS, Charalampos	1009	GRE 	M	25	24	25	23	25	122+3	26	17
5	PETIT, Emmanuel, Stéphane	1008	FRA 	M	24	25	25	25	25	124	24	
6	VASILIOU, Nicolas	1004	CYP 	M	24	25	24	25	22	120+8	24	
7	DELAUNAY, Eric, Allain, Christophe	1007	FRA 	M	24	25	24	24	25	122+34	16	
8	ATTARD, Marlon	1014	MLT 	M	25	25	24	23	25	122+33	15	
9	CASSANDRO, Tammaro	1011	ITA 	M	24	23	25	24	23	119+15		
10	ROSSETTI, Gabriele	1012	ITA 	M	23	25	24	24	23	119+7		
11	SAHIN, Mustafa Serhat	1018	TUR 	M	24	23	24	24	24	119+3		
12	AMORELKBIR, Nadjib	1001	ALG 	M	22	24	25	24	23	118		
13	ATTARD, Marcello	1013	MLT 	M	24	24	23	24	23	118		
14	SHARAF, Ibrahim	1006	EGY 	M	24	22	21	24	24	115		
15	AHMET, Baran	1017	TUR 	M	23	23	21	25	20	112		
16	NECIB, Isam	1002	ALG 	M	21	20	23	24	19	107		
17	OUEDERNI, Ahmed Dhia	1016	TUN 	M	19	21	23	20	23	106		
18	BEN CHARADA, Sabil	1015	TUN 	M	23	19	20	22	20	104		



# RESULTS

## 10M AIR RIFLE WOMEN

### MEDAL MATCH

FRI 01 JUL 2022, START TIME 11:30

Rk	Bib No	Name	Nat	1	2	3	4	5	6	7	8	9	10	11	12	13	14	15	16	Tot.	Remarks	
1	166	MULLER Océanne	FRA	2	2	2	2	2	2	0	0	0	2	2							16.0	<b>GOLD</b>
2	181	VUKOJEVIC Teodora	SRB	0	0	0	0	0	0	2	2	2	0	0							6.0	<b>SILVER</b>
				9.9	10.5	10.3	10.0	10.6	10.2	10.6	10.9	10.6	9.9	10.3								

Legend:

Rk	Rank	Bib No	Bib Number	Nat	Nation
Tot.	Total				



## RESULTS

### 10M AIR RIFLE WOMEN

### RANKING MATCH

FRI 01 JUL 2022, START TIME 11:30

Rk	Bib No	Name	Nat	Ser 1	Ser 2	Ser 3	Ser 4	Ser 5	Total	Remarks
1	166	MULLER Océanne	FRA	52.9	52.9	52.8	52.2	52.8	<b>263.6</b>	GMM
2	181	VUKOJEVIC Teodora	SRB	52.2	51.9	52.1	52.4	52.4	<b>261.0</b>	GMM
3	133	DVORSAK Ziva	SLO	51.7	52.2	52.1	52.3	51.7	<b>260.0</b>	BR
4	143	GRANDE MARTINEZ Paula	ESP	51.7	52.4	51.2	52.2	52.1	<b>259.6</b>	
5	122	CECCARELLO Sofia	ITA	50.2	52.8	51.9	52.4		<b>207.3</b>	
6	149	JEROVSEK Klavdija	SLO	50.8	52.9	51.3	51.6		<b>206.6</b>	
7	118	BORDET Jade	FRA	51.3	51.5	51.7			<b>154.5</b>	
8	184	MARTINON BORRAS Ines	ESP	52.0	50.3	51.3			<b>153.6</b>	

Legend:

Rk	Rank	Bib No	Bib Number	Nat	Nation
Ser	Series	GMM	Gold Medal Match	BR	

# RESULTS

## 10M AIR RIFLE WOMEN

### QUALIFICATION

FRI 01 JUL 2022, START TIME 09:15

Records

QMGR	627.9	ZIVIANI, Martina	ITA	24 JUN 2018	MED Games	Tarragona (ESP)
------	-------	------------------	-----	-------------	-----------	-----------------

Rk	Bib No	Name	Nat	Series						Total	Remarks
				1	2	3	4	5	6		
1	143	GRANDE MARTINEZ Paula	ESP	104.6	105.3	105.3	105.7	105.1	104.6	630.6	QF,QMGR
2	122	CECCARELLO Sofia	ITA	105.0	105.3	104.9	105.2	104.3	105.2	629.9	QF
3	166	MULLER Océanne	FRA	104.0	105.3	105.4	105.2	104.2	104.1	628.2	QF
4	133	DVORSAK Ziva	SLO	103.7	104.0	104.9	105.6	103.7	106.1	628.0	QF
5	149	JEROVSEK Klavdija	SLO	105.0	102.7	105.7	104.8	105.2	104.2	627.6	QF
6	184	MARTINON BORRAS Ines	ESP	104.6	105.4	104.7	103.7	105.0	104.2	627.6	QF
7	118	BORDET Jade	FRA	103.6	106.3	103.1	105.2	104.7	104.4	627.3	QF
8	181	VUKOJEVIC Teodora	SRB	105.9	104.1	104.1	104.2	104.2	104.0	626.5	QF
9	183	ZIVIANI Martina	ITA	104.5	103.7	103.8	106.5	103.6	104.3	626.4	
10	144	GUSTIN Valentina	CRO	104.6	104.4	104.7	103.7	104.0	104.4	625.8	
11	106	ARSOVIC Andrea	SRB	103.9	103.4	104.2	104.6	104.2	104.2	624.5	
12	128	CHAABI Houda	ALG	104.0	103.1	103.2	104.2	104.8	103.6	622.9	
13	132	ANTUNES Sara	POR	104.2	103.4	104.0	104.2	102.4	103.4	621.6	
14	165	MOJSOVSKA Anastasija	MKD	103.5	102.0	104.2	103.0	102.2	104.9	619.8	
15	153	KOCA Seymanur	TUR	101.2	102.3	102.0	104.0	104.6	104.3	618.4	
16	116	BJELOSEVIC Segmedina	BIH	102.6	102.8	103.1	103.8	103.5	102.6	618.4	
17	146	HERCEG Estera	CRO	102.9	105.1	102.5	101.2	103.3	103.2	618.2	
18	145	HAMDANI Inssaf	ALG	102.3	102.1	100.0	102.4	101.2	103.6	611.6	
19	167	ONESCUK Farah	BIH	103.1	101.0	102.8	102.5	101.5	100.3	611.2	
20	182	ZITOUNI Manel	TUN	101.4	100.8	102.3	100.0	103.5	101.1	609.1	
21	161	MARKIDOU Konstantina	CYP	99.5	101.8	100.3	103.7	101.7	101.7	608.7	
22	130	DELEN Gulsen	TUR	98.6	102.6	102.0	102.7	100.7	101.5	608.1	
23	105	ANXHARA Kristina	ALB	101.2	101.8	102.4	100.6	97.8	101.6	605.4	

**Summary:**

Number of athletes on this list: 23; Total number of athletes: 23

**Legend:**

QMGR	Qualification Mediterranean Games Record	Rk	Rank	Bib No	Bib Number
Nat	Nation	QF	Qualified for Final		



## RESULTS

### 10M AIR PISTOL WOMEN

### MEDAL MATCH

SAT 02 JUL 2022, START TIME 11:30

Rk	Bib No	Name	Nat	1	2	3	4	5	6	7	8	9	10	11	12	13	14	15	16	Tot.	Remarks
1	155	KORAKAKI Anna	GRE	2	0	0	2	0	2	2	0	0	1	2	2	2	0	2		<b>17.0</b>	<b>GOLD</b>
2	148	JEDRZEJEWSKI Camille	FRA	0	2	2	0	2	0	0	2	2	1	0	0	0	2	0		<b>13.0</b>	<b>SILVER</b>
				9.3	9.9	10.4	10.3	10.4	9.7	10.0	10.6	10.3	10.2	9.8	10.5	9.6	10.3	9.1			

Legend:

Rk	Rank	Bib No	Bib Number	Nat	Nation
Tot.	Total				



## RESULTS

### 10M AIR PISTOL WOMEN

#### RANKING MATCH

SAT 02 JUL 2022, START TIME 11:30

Rk	Bib No	Name	Nat	Ser 1	Ser 2	Ser 3	Ser 4	Ser 5	Total	Remarks
1	148	JEDRZEJEWSKI Camille	FRA	50.6	50.7	50.1	51.1	50.1	<b>252.6</b>	GMM
2	155	KORAKAKI Anna	GRE	51.1	49.8	50.3	48.6	48.9	<b>248.7</b>	GMM
3	107	ARUNOVIC Zorana	SRB	51.7	50.2	48.1	50.1	48.5	<b>248.6</b>	BR
4	178	TARHAN Sevval Ilayda	TUR	48.5	48.4	49.6	50.5	47.6	<b>244.6</b>	
5	140	GIANCAMILI Chiara	ITA	49.8	50.4	48.4	48.4		<b>197.0</b>	SO
6	108	ASIK Elif Beyza	TUR	48.5	49.7	48.6	47.3		<b>194.1</b>	
7	129	DE PAIVA CASTELÃO MARTINS Joana	POR	46.4	50.1	45.7			<b>142.2</b>	
8	141	GOBERVILLE Céline	FRA	47.5	45.4	48.6			<b>141.5</b>	

#### Legend:

Rk	Rank	Bib No	Bib Number	Nat	Nation
Ser	Series	GMM	Gold Medal Match	BR	Bronze
SO	Athlete eliminated by Shoot-off for tie				





# RESULTS

## 10M AIR PISTOL WOMEN

### QUALIFICATION

SAT 02 JUL 2022, START TIME 09:15

Records

QMGR	575	KORAKAKI, Anna	GRE	23 JUN 2018	MED Games	Tarragona (ESP)
------	-----	----------------	-----	-------------	-----------	-----------------

Rk	Bib No	Name	Nat	Series						Total	Remarks
				1	2	3	4	5	6		
1	155	KORAKAKI Anna	GRE	98	99	98	96	99	98	<b>588-23x</b>	QF,QMGR
2	148	JEDRZEJEWSKI Camille	FRA	94	98	96	98	97	97	<b>580-15x</b>	QF
3	107	ARUNOVIC Zorana	SRB	96	95	97	96	96	97	<b>577-19x</b>	QF
4	141	GOBERVILLE Céline	FRA	96	96	95	96	97	95	<b>575-19x</b>	QF
5	140	GIANCAMILI Chiara	ITA	92	96	93	98	95	97	<b>571-15x</b>	QF
6	129	DE PAIVA CASTELÃO MARTINS Joana	POR	94	96	95	97	95	92	<b>569-18x</b>	QF
7	178	TARHAN Sevval Ilayda	TUR	94	95	94	94	93	96	<b>566-18x</b>	QF
8	108	ASIK Elif Beyza	TUR	92	94	97	95	94	94	<b>566-13x</b>	QF
9	124	CHALGHOUM Doua	TUN	95	93	93	94	94	95	<b>564-13x</b>	
10	180	VARRICCHIO Maria	ITA	92	95	95	93	92	96	<b>563-10x</b>	
11	127	CHERNI Olfa	TUN	95	92	97	94	94	91	<b>563-9x</b>	
12	114	BEZZINA Eleanor	MLT	92	93	95	92	97	93	<b>562-17x</b>	
13	117	BOLA UJCIC Denis	SLO	95	93	92	93	93	95	<b>561-9x</b>	
14	137	FRANQUET CALVENTE Sonia	ESP	98	92	94	93	87	93	<b>557-13x</b>	
15	175	SCURI Sara	SLO	93	94	94	90	91	90	<b>552-12x</b>	
16	139	GEORGIU Christiana	CYP	89	91	94	88	92	94	<b>548-11x</b>	
17	111	BENFALAMI Rachida	ALG	91	92	93	88	94	88	<b>546-11x</b>	
18	126	CHARALAMBOUS Panagiota	CYP	85	92	91	90	97	89	<b>544-10x</b>	
19	162	MEDJIAH Halla	ALG	96	91	90	90	90	87	<b>544-6x</b>	
	154	KONINI Manjola	ALB								DNS

**Summary:**

Number of athletes on this list: 20; Total number of athletes: 20







**Legend:**

QMGR	Qualification Mediterranean Games Record	Rk	Rank	Bib No	Bib Number
Nat	Nation	QF	Qualified for Final	DNS	Did not Start

## TR125

### Classification: Women - TRAP

Page 1 of 1





Pos.	Name	Bib	NOC	Cat	R1	R2	R3	R4	R5	Qua	Semi-Final	Final		
1	CORMENIER, Carole, Marie	1009	FRA		W	23	24	23	24	23	117	17	28	<b>GOLD</b>
2	COELHO DE BARROS, Maria Ines	1014	POR		W	25	23	24	24	23	119*	19	27	<b>SILVER</b>
3	STANCO, Silvana Maria	1012	ITA		W	24	22	24	24	24	118	20	17	<b>BRONZE</b>
4	MARIRHI, Yasmine	1013	MAR		W	20	23	25	21	24	113+0+0	16	9	
5	MACHADO RODRIGUES, Ana Rita	1015	POR		W	24	21	23	24	23	115	15		
6	ROSSI, Jessica	1011	ITA		W	24	23	21	24	24	116	13		
7	MOLNE MAGRINA, Mar	1008	ESP		W	25	23	21	21	23	113+0+1	9		
8	COUZY, Melanie	1010	FRA		W	24	22	23	23	21	113+1	6		
9	KAYA, Rumeysa Pelin	1017	TUR		W	24	22	22	21	23	112			
10	SARITURK TEMIZDEMIR, Safiye	1018	TUR		W	20	22	23	22	23	110			
11	KONSTANTINIDOU, Georgia	1004	CYP		W	23	19	22	24	22	110			
12	PERILLI, Alessandra	1016	SMR		W	22	22	23	21	22	110			
13	ASHMAWY, Maggy	1005	EGY		W	18	25	20	22	23	108			
14	IERIDES, Andi	1003	CYP		W	25	19	22	20	20	106			
15	IBRAHIM, Mrs. Sahar	1006	EGY		W	15	20	16	15	22	88			
16	BENKHOUCHA, Lynda	1001	ALG		W	0	0	0	0	0	0			<b>DNS</b>
16	GALVEZ MARIN, Fatima	1007	ESP		W	0	0	0	0	0	0			<b>DNS</b>
16	ZEGGANE, Saadia	1002	ALG		W	0	0	0	0	0	0			<b>DNS</b>

\* EQUALED QUALIFICATION MEDITERRANEAN GAMES RECORD

## SK125

### Classification: Women - SKEET

Page 1 of 1

Pos.	Name	Bib	NOC	Cat	R1	R2	R3	R4	R5	Qua	Semi-Final	Final	
1	BARTOLOMEI, Martina	1025	ITA 	W	21	24	23	24	23	115	24	34	<b>GOLD</b>
2	KATZOURAKI, Emmanouela	1023	GRE 	W	23	25	25	24	23	120+4*	26	33	<b>SILVER</b>
3	BACOSI, Diana	1024	ITA 	W	25	22	24	25	24	120+1*	26	25	<b>BRONZE</b>
4	ANASTASSIOU, Lucie, Amélie	1021	FRA 	W	24	22	25	24	25	120+3*	26	16	
5	BATTAULT, Noémie	1022	FRA 	W	23	24	22	23	25	117	23		
6	MARIRHI, Ibtissam	1026	MAR 	W	24	24	20	24	24	116	22		
7	BALKANCI, Nur Banu	1027	TUR 	W	23	24	18	20	25	110+3	16		
8	NIKOLAOU, Konstantia	1020	CYP 	W	22	21	24	22	23	112	15		
9	CAN, Sena	1028	TUR 	W	17	24	24	22	23	110+2			
10	ANDREOU, Panagiota	1019	CYP 	W	24	21	22	22	20	109			

\* Qualification Mediterranean Games Record



# RESULTS

## 10M AIR RIFLE MIXED TEAM

### GOLD MEDAL MATCH

SAT 02 JUL 2022, START TIME 12:30

Rk	Name	1	2	3	4	5	6	7	8	9	10	11	12	13	14	15	16	17	18	19	20	Tot.	Remarks	
<b>1</b>	<b>France 1</b>	<b>2</b>	<b>0</b>	<b>2</b>	<b>2</b>	<b>2</b>	<b>1</b>	<b>0</b>	<b>1</b>	<b>2</b>	<b>2</b>	<b>2</b>										<b>16</b>	<b>GOLD</b>	
	MULLER, Océanne	10.8	10.2	10.7	10.5	10.3	10.5	10.5	10.6	10.9	10.8	10.4												
	BAUDOUIN, Brian	10.1	9.6	10.3	10.6	10.6	10.3	10.2	10.5	10.4	10.4	10.8												
<b>2</b>	<b>Serbia 1</b>	<b>0</b>	<b>2</b>	<b>0</b>	<b>0</b>	<b>0</b>	<b>1</b>	<b>2</b>	<b>1</b>	<b>0</b>	<b>0</b>	<b>0</b>										<b>6</b>	<b>SILVER</b>	
	ARSOVIC, Andrea	10.1	10.7	10.6	10.0	10.7	10.1	10.7	10.7	10.4	10.2	10.5												
	KOVACEVIC, Lazar	10.3	10.4	10.2	10.5	9.9	10.7	10.1	10.4	10.8	10.6	9.7												

Legend:

Rk Rank Tot. Total



# RESULTS

## 10M AIR RIFLE MIXED TEAM

### BRONZE MEDAL MATCH

SAT 02 JUL 2022, START TIME 12:30

Rk	Name	1	2	3	4	5	6	7	8	9	10	11	12	13	14	15	16	17	18	19	20	Tot.	Remarks	
<b>3</b>	<b>Slovenia 1</b>	0	2	2	2	2	2	2	0	0	0	2	0	1	1								<b>16</b>	<b>BRONZE</b>
	DVORSAK, Ziva	10.410.710.710.610.210.610.310.010.310.410.610.410.6	9.9																					
	LUKIC, Luka	10.510.610.610.410.810.410.810.010.310.510.510.410.6																						
<b>4</b>	<b>Croatia 1</b>	2	0	0	0	0	0	0	2	2	2	0	2	1	1								<b>12</b>	
	GUSTIN, Valentina	10.510.6	9.5	9.9	10.910.410.610.610.710.7	9.3	10.410.5	9.9																
	MARICIC, Miran	10.610.410.7	9.9	9.9	10.410.010.310.610.910.310.810.510.6																			

Legend:

Rk Rank Tot. Total



# RESULTS

## 10M AIR RIFLE MIXED TEAM QUALIFICATION

SAT 02 JUL 2022, START TIME 11:00

Records

QMGR

Not established

Rk	Bib No	Name	Series			Total	Remarks
			1	2	3		
<b>1</b>		<b>FRA - France 1</b>	<b>210.9</b>	<b>212.4</b>	<b>209.3</b>	<b>632.6</b>	<b>QMGR</b>
	166	MULLER Océanne	106.6	105.9	104.1	316.6	GM
	110	BAUDOUIN Brian	104.3	106.5	105.2	316.0	GM
<b>2</b>		<b>SRB - Serbia 1</b>	<b>208.7</b>	<b>209.5</b>	<b>209.6</b>	<b>627.8</b>	
	157	KOVACEVIC Lazar	104.9	104.2	105.2	314.3	GM
	106	ARSOVIC Andrea	103.8	105.3	104.4	313.5	GM
<b>3</b>		<b>CRO - Croatia 1</b>	<b>207.4</b>	<b>209.3</b>	<b>210.2</b>	<b>626.9</b>	
	160	MARICIC Miran	104.4	104.8	104.8	314.0	BM
	144	GUSTIN Valentina	103.0	104.5	105.4	312.9	BM
<b>4</b>		<b>SLO - Slovenia 1</b>	<b>209.7</b>	<b>208.0</b>	<b>207.2</b>	<b>624.9</b>	
	133	DVORSAK Ziva	104.8	104.0	104.4	313.2	BM
	158	LUKIC Luka	104.9	104.0	102.8	311.7	BM
<b>5</b>		<b>ESP - Spain 1</b>	<b>206.0</b>	<b>210.5</b>	<b>207.7</b>	<b>624.2</b>	
	143	GRANDE MARTINEZ Paula	103.6	105.2	104.6	313.4	
	169	OVIEDO BERENGUER Jesus	102.4	105.3	103.1	310.8	
<b>6</b>		<b>TUR - Turkiye 1</b>	<b>207.7</b>	<b>207.7</b>	<b>208.5</b>	<b>623.9</b>	
	153	KOCA Seymanur	103.8	104.7	105.2	313.7	
	103	AKGUN Omer	103.9	103.0	103.3	310.2	
<b>7</b>		<b>SRB - Serbia 2</b>	<b>209.6</b>	<b>207.8</b>	<b>206.5</b>	<b>623.9</b>	
	181	VUKOJEVIC Teodora	105.9	103.6	103.8	313.3	
	176	SEBIC Milenko	103.7	104.2	102.7	310.6	
<b>8</b>		<b>FRA - France 2</b>	<b>208.1</b>	<b>208.0</b>	<b>207.4</b>	<b>623.5</b>	
	173	RAYNAUD Alexis	104.0	104.8	103.1	311.9	
	118	BORDET Jade	104.1	103.2	104.3	311.6	
<b>9</b>		<b>ITA - Italy 1</b>	<b>206.6</b>	<b>209.8</b>	<b>207.0</b>	<b>623.4</b>	
	122	CECCARELLO Sofia	105.4	105.5	105.0	315.9	
	113	BERNARDI Michele	101.2	104.3	102.0	307.5	
<b>10</b>		<b>ITA - Italy 2</b>	<b>206.4</b>	<b>209.5</b>	<b>207.1</b>	<b>623.0</b>	
	183	ZIVIANI Martina	104.0	105.4	102.6	312.0	
	121	CAPANO Giuseppe Pio	102.4	104.1	104.5	311.0	
<b>11</b>		<b>CRO - Croatia 2</b>	<b>205.7</b>	<b>208.0</b>	<b>208.2</b>	<b>621.9</b>	
	170	PETANJEK Borna	103.0	105.1	104.6	312.7	
	146	HERCEG Estera	102.7	102.9	103.6	309.2	
<b>12</b>		<b>SLO - Slovenia 2</b>	<b>207.5</b>	<b>207.2</b>	<b>205.8</b>	<b>620.5</b>	
	149	JEROVSEK Klavdija	104.3	103.4	102.7	310.4	
	177	SOCIC Jure	103.2	103.8	103.1	310.1	
<b>13</b>		<b>BIH - Bosnia and Herzegovina 1</b>	<b>208.1</b>	<b>205.5</b>	<b>204.7</b>	<b>618.3</b>	
	116	BJELOSEVIC Segmedina	103.6	102.5	103.2	309.3	
	134	DZANKOVIC Nedžad	104.5	103.0	101.5	309.0	
<b>14</b>		<b>ESP - Spain 2</b>	<b>206.8</b>	<b>205.7</b>	<b>205.7</b>	<b>618.2</b>	
	184	MARTINON BORRAS Ines	103.2	103.9	102.2	309.3	
	142	GONZALEZ BOCERO Adrian	103.6	101.8	103.5	308.9	
<b>15</b>		<b>BIH - Bosnia and Herzegovina 2</b>	<b>205.0</b>	<b>205.7</b>	<b>205.4</b>	<b>616.1</b>	
	167	ONESCUK Farah	103.8	103.8	103.4	311.0	
	172	RASIC Matej	101.2	101.9	102.0	305.1	
<b>16</b>		<b>TUR - Turkiye 2</b>	<b>201.6</b>	<b>202.7</b>	<b>206.0</b>	<b>610.3</b>	
	151	KARABINA Yusuf	99.6	102.9	103.0	305.5	
	130	DELEN Gulsen	102.0	99.8	103.0	304.8	

Rk	Bib No	Name	Series			Total	Remarks
			1	2	3		
<b>17</b>		<b>TUN - Tunisia</b>	<b>204.3</b>	<b>202.2</b>	<b>201.5</b>	<b>608.0</b>	
	109	AZIZI Alaa Eddine	104.1	100.7	102.0	306.8	
	182	ZITOUNI Manel	100.2	101.5	99.5	301.2	
<b>18</b>		<b>ALG - Algeria</b>	<b>202.5</b>	<b>202.4</b>	<b>201.8</b>	<b>606.7</b>	
	112	BENZIDANE Reda	100.7	102.1	102.4	305.2	
	145	HAMDANI Inssaf	101.8	100.3	99.4	301.5	
<b>19</b>		<b>CYP - Cyprus</b>	<b>204.5</b>	<b>199.6</b>	<b>202.3</b>	<b>606.4</b>	
	125	CHARALAMBOUS Andreas	103.4	100.0	101.1	304.5	
	161	MARKIDOU Konstantina	101.1	99.6	101.2	301.9	

**Legend:**

<b>QMGR</b>	<b>Qualification Mediterranean Games Record</b>	<b>Rk</b>	<b>Rank</b>	<b>Bib No</b>	<b>Bib Number</b>
<b>GM</b>	<b>Gold Medals</b>	<b>BM</b>	<b>Bronze Medals</b>		



**RESULTS**  
**AIR PISTOL MIXED TEAM**  
**GOLD MEDAL MATCH**  
WED 29 JUN 2022, START TIME 11:30

Rk	Name	1	2	3	4	5	6	7	8	9	10	11	12	13	14	15	16	17	18	19	20	Tot.	Remarks	
<b>1</b>	<b>Serbia</b>	<b>0</b>	<b>2</b>	<b>2</b>	<b>2</b>	<b>0</b>	<b>2</b>	<b>0</b>	<b>0</b>	<b>2</b>	<b>2</b>	<b>2</b>	<b>0</b>	<b>2</b>								<b>16</b>	<b>GOLD</b>	
	ARUNOVIC, Zorana	9.6	10.1	9.9	10.4	9.9	10.8	10.6	9.5	10.1	10.4	9.5	10.3	9.7										
	MIKEC, Damir	9.4	10.7	10.6	9.9	9.3	9.7	9.1	10.1	10.5	10.5	10.1	9.2	10.1										
<b>2</b>	<b>France</b>	<b>2</b>	<b>0</b>	<b>0</b>	<b>0</b>	<b>2</b>	<b>0</b>	<b>2</b>	<b>2</b>	<b>0</b>	<b>0</b>	<b>0</b>	<b>2</b>	<b>0</b>								<b>10</b>	<b>SILVER</b>	
	JEDRZEJEWSKI, Camille	9.7	9.0	10.7	9.4	10.5	9.5	10.3	10.0	10.3	9.8	9.9	10.4	9.3										
	FOUQUET, Florian	10.1	9.5	9.1	9.8	9.8	9.0	9.8	9.8	8.1	9.7	9.5	9.6	10.0										

Legend:

Rk Rank Tot. Total





**RESULTS**  
**AIR PISTOL MIXED TEAM**  
**BRONZE MEDAL MATCH**  
WED 29 JUN 2022, START TIME 11:30

Rk	Name	1	2	3	4	5	6	7	8	9	10	11	12	13	14	15	16	17	18	19	20	Tot.	Remarks	
<b>3</b>	<b>Italy 2</b>	<b>2</b>	<b>2</b>	<b>0</b>	<b>2</b>	<b>2</b>	<b>0</b>	<b>0</b>	<b>2</b>	<b>0</b>	<b>0</b>	<b>2</b>	<b>0</b>	<b>0</b>	<b>2</b>	<b>2</b>						<b>16</b>	<b>BRONZE</b>	
	GIANCAMILI, Chiara	9.6	9.9	9.8	9.3	9.2	9.2	10.5	10.1	9.9	9.9	9.7	6.8	9.8	10.0	10.1								
	TESCONI, Luca	10.1	9.5	8.8	9.9	10.5	8.9	9.0	10.3	9.8	10.2	10.6	9.5	8.9	9.4	9.4								
<b>4</b>	<b>Türkiye 2</b>	<b>0</b>	<b>0</b>	<b>2</b>	<b>0</b>	<b>0</b>	<b>2</b>	<b>2</b>	<b>0</b>	<b>2</b>	<b>2</b>	<b>0</b>	<b>2</b>	<b>0</b>	<b>2</b>	<b>0</b>						<b>14</b>		
	ASIK, Elif Beyza	7.7	8.2	9.5	8.7	10.0	9.1	9.7	9.3	9.7	10.5	9.1	10.2	9.7	8.6	9.5								
	KELES, Ismail	10.1	9.8	9.6	10.3	9.6	10.4	10.0	9.6	10.1	10.1	10.1	9.9	10.1	10.4	9.0								

Legend:

Rk Rank Tot. Total



## RESULTS

### 10M AIR PISTOL MIXED TEAM QUALIFICATION

WED 29 JUN 2022, START TIME 09:15

Rk	Bib No	Name	Series			Total	Remarks
			1	2	3		
<b>1</b>		<b>SRB - Serbia</b>	<b>193</b>	<b>188</b>	<b>195</b>	<b>576-14x</b>	<b>QMGR</b>
	164	MIKEC Damir	96	95	98	289- 7x	GM
	107	ARUNOVIC Zorana	97	93	97	287- 7x	GM
<b>2</b>		<b>FRA - France</b>	<b>192</b>	<b>189</b>	<b>192</b>	<b>573-11x</b>	
	148	JEDRZEJEWSKI Camille	98	95	96	289- 6x	GM
	136	FOUQUET Florian	94	94	96	284- 5x	GM
<b>3</b>		<b>TUR - Türkiye 2</b>	<b>187</b>	<b>190</b>	<b>191</b>	<b>568-15x</b>	
	152	KELES Ismail	92	97	97	286-10x	BM
	108	ASIK Elif Beyza	95	93	94	282- 5x	BM
<b>4</b>		<b>ITA - Italy 2</b>	<b>192</b>	<b>190</b>	<b>186</b>	<b>568-15x</b>	
	179	TESCONI Luca	97	96	92	285-10x	BM
	140	GIANCAMILI Chiara	95	94	94	283- 5x	BM
<b>5</b>		<b>GRE - Greece</b>	<b>188</b>	<b>189</b>	<b>190</b>	<b>567-11x</b>	
	155	KORAKAKI Anna	96	96	95	287- 6x	
	156	KORAKAKIS Dionysios	92	93	95	280- 5x	
<b>6</b>		<b>TUR - Türkiye 1</b>	<b>185</b>	<b>185</b>	<b>195</b>	<b>565-14x</b>	
	131	DIKEC Yusuf	92	95	96	283- 7x	
	178	TARHAN Sevvall Ilayda	93	90	99	282- 7x	
<b>7</b>		<b>ITA - Italy 1</b>	<b>186</b>	<b>187</b>	<b>190</b>	<b>563-14x</b>	
	159	MALDINI Federico Nilo	95	93	96	284- 9x	
	180	VARRICCHIO Maria	91	94	94	279- 5x	
<b>8</b>		<b>ALG - Algeria 1</b>	<b>189</b>	<b>186</b>	<b>185</b>	<b>560-10x</b>	
	101	ADJABI Amine	96	94	92	282- 4x	
	162	MEDJIAH Halla	93	92	93	278- 6x	
<b>9</b>		<b>POR - Portugal</b>	<b>190</b>	<b>185</b>	<b>185</b>	<b>560- 7x</b>	
	120	CALVETE PEREIRA DA COSTA João	97	94	94	285- 5x	
	129	DE PAIVA CASTELÃO MARTINS Joana	93	91	91	275- 2x	
<b>10</b>		<b>TUN - Tunisia</b>	<b>178</b>	<b>192</b>	<b>186</b>	<b>556-11x</b>	
	168	OTHMANI Alaa	93	96	95	284- 8x	
	127	CHERNI Olfa	85	96	91	272- 3x	
<b>11</b>		<b>SLO - Slovenia</b>	<b>183</b>	<b>188</b>	<b>183</b>	<b>554-10x</b>	
	123	CEPER Joze	92	98	93	283- 5x	
	117	BOLA UJCIC Denis	91	90	90	271- 5x	
<b>12</b>		<b>ALG - Algeria 2</b>	<b>185</b>	<b>181</b>	<b>186</b>	<b>552- 9x</b>	
	163	MEHALI Tayeb	95	91	93	279- 6x	
	111	BENFALAMI Rachida	90	90	93	273- 3x	
<b>13</b>		<b>ESP - Spain</b>					
	137	FRANQUET CALVENTE Sonia					DNS
	138	FREIJE TORNEIRO Martin					DNS

Revised





Legend:

Rk	Rank	Bib No	Bib Number	QMGR	New Qualification Mediterranean Games Record
GM	Gold Medals	BM	Bronze Medals	DNS	Did not Start

## SKEET MIXED TEAM

### Classification: Skmix - W/M - SKEET

Page 1 of 1

Pos.	Name	Bib	NOC	Cat	R1	R2	R3	Qua	Medal Match	Remarks
1	FRANCE 2		FRA 		48	50	48	146*	2 0 2 2	6 <b>GOLD</b>
	PETIT, Emmanuel	1008	FRA	M	25	25	25	75	4 4 3 4	
	BATTAULT, Noemie	1022	FRA	W	23	25	23	71	3 3 3 4	
2	ITALY 1		ITA 		49	47	50	146*	0 2 0 0	2 <b>SILVER</b>
	CASSANDRO, Tamaro	1011	ITA	M	24	24	25	73	3 4 3 3	
	BACOSI, Diana	1024	ITA	W	25	23	25	73	2 4 2 4	
3	ITALY 2		ITA 		47	50	48	145	0 1 2 2 2	7 <b>BRONZE</b>
	ROSSETTI, Gabriele	1012	ITA	M	23	25	25	73	1 3 4 4 4	
	BARTOLOMEI, Martina	1025	ITA	W	24	25	23	72	3 3 4 4 4	
4	CYPRUS 2		CYP 		49	47	48	144	2 1 0 0 0	3
	NIKOLAIDIS, Stefanos	1003	CYP	W	24	24	23	71	3 4 3 4 3	
	NIKOLAOU, Kostantia	1020	CYP	M	25	23	25	73	4 2 4 3 3	
5	CYPRUS 1		CYP 		48	50	45	143		
	VASILIOU, Nicolas	1004	CYP	M	25	25	25	75		
	ANDREOU, Panagiota	1019	CYP	W	23	25	20	68		
6	GREECE		GRE 		48	46	48	142		
	MITAS, Efthymios	1010	GRE	M	25	23	25	73		
	KATZOURAKI, Emmanouel	1023	GRE	W	23	23	23	69		
7	FRANCE 1		FRA 		47	49	45	141		
	DELAUNAY, Eric	1007	FRA	M	24	25	25	74		
	ANASTASSIOU, Lucie	1021	FRA	W	23	24	20	67		
8	TURKIYE 1		TUR 		44	46	24	114		
	SAHIN, Mustafa Serhat	1018	TUR	M	22	24	24	70		
	BALKANCI, Nur Banu	1027	TUR	W	22	22	0	44		
9	TURKIYE 2		TUR 		47	43	44	134		
	AHMET, Baran	1017	TUR	M	25	24	24	73		
	CAN, Sena	1028	TUR	W	22	19	20	61		

\* Qualification Mediterranean Games Record



ألعاب البحر الأبيض المتوسط  
MEDITERRANEAN GAMES  
JEUX MÉDITERRANÉENS  
du 25 juin au 06 juillet

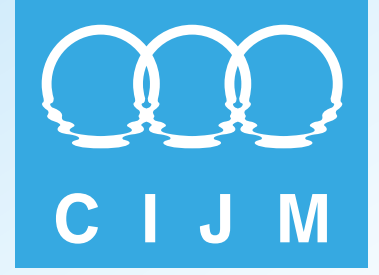

# Results Book



## Swimming



**TOSYALI  
ALGERIE**

Fer et Acier

سوناطراي



sonarach



microplus  
DATA PROCESSING & TIMING  
[www.microplustiming.com](http://www.microplustiming.com)

# Swimming



## Medallists by Event

MEDAL	SURNAME & NAME	DATE OF BIRTH	NOC	TIME	
<b>50m Freestyle Women</b>					
GOLD	MUNOZ DEL CAMPO Lidon		ESP	24.97	
SILVER	KLANCAR Neza		SLO	25.01	
BRONZE	ANTONIOU Kalia		CYP	25.06	
<b>100m Freestyle Women</b>					
GOLD	ANTONIOU Kalia		CYP	54.36	CR
SILVER	SEGEL Janja		SLO	54.48	
BRONZE	KLANCAR Neza		SLO	55.31	
<b>200m Freestyle Women</b>					
GOLD	SEGEL Janja		SLO	1:56.68	CR
SILVER	FAIN Katja		SLO	1:57.49	
BRONZE	MIZZAU Alice		ITA	1:59.95	
<b>400m Freestyle Women</b>					
GOLD	ERTAN Deniz		TUR	4:08.04	
SILVER	FAIN Katja		SLO	4:09.07	
BRONZE	CESARANO Antonietta		ITA	4:10.13	
<b>800m Freestyle Women</b>					
GOLD	TUNCEL Merve		TUR	8:26.80	
SILVER	ERTAN Deniz		TUR	8:29.03	
BRONZE	CARAMIGNOLI Martina Rita		ITA	8:31.75	
<b>50m Backstroke Women</b>					
GOLD	STANISAVLJEVIC Nina		SRB	28.59	
SILVER	NTOUNTOUNAKI Anna		GRE	28.68	
BRONZE	AMADO GOMES Rafaela		POR	28.86	
<b>100m Backstroke Women</b>					
GOLD	RODRIGUES REBELO Camila		POR	1:01.34	
SILVER	ZOFKOVA COSTA Carlotta		ITA	1:01.61	
BRONZE	WEILER SASTRE Carmen		ESP	1:01.98	

### 200m Backstroke Women

GOLD	RODRIGUES REBELO Camila		POR	2:10.41
SILVER	ZAMORANO SANZ Africa		ESP	2:11.48
BRONZE	AVRAMOVA Ekaterina		TUR	2:12.72

### 50m Breaststroke Women

GOLD	ANGIOLINI Lisa		ITA	30.87	CR
SILVER	DE PINHO RODRIGUES Ana		POR	31.31	
BRONZE	BOTTAZZO Anita		ITA	31.41	

### 100m Breaststroke Women

GOLD	ANGIOLINI Lisa		ITA	1:07.59
SILVER	BOTTAZZO Anita		ITA	1:08.14
BRONZE	GUNES Viktoria		TUR	1:08.44

### 200m Breaststroke Women

GOLD	GUNES Viktoria		TUR	2:26.48
SILVER	GARCIA URZAINQUI Marina		ESP	2:27.32
BRONZE	GOMES RAMOS Raquel		POR	2:28.35

### 50m Butterfly Women

GOLD	NTOUNTOUNAKI Anna		GRE	25.95
SILVER	SCOTTO DI CARLO Viola		ITA	26.25
BRONZE	LAQUINTANA Sonia		ITA	26.38

### 100m Butterfly Women

GOLD	PUDAR Lana		BIH	57.55	CR
SILVER	NTOUNTOUNAKI Anna		GRE	58.56	
BRONZE	BIANCHI Ilaria		ITA	59.06	

### 200m Butterfly Women

GOLD	PUDAR Lana		BIH	2:09.18
SILVER	CUNHA Ana		POR	2:09.32
BRONZE	TUNCEL Merve		TUR	2:12.59

### 200m Individual Medley Women

GOLD	FRANCESCHI Sara		ITA	2:12.19
SILVER	GUNES Viktoria		TUR	2:12.26
BRONZE	ERTAN Deniz		TUR	2:14.15

### 400m Individual Medley Women

GOLD	<b>FRANCESCHI Sara</b>		ITA	4:40.86
SILVER	<b>ERTAN Deniz</b>		TUR	4:40.97
BRONZE	<b>VAZQUEZ RUIZ Alba</b>		ESP	4:45.63

### 4 x 100m Freestyle Women

GOLD	<b>SLOVENIA</b> SEGEL Janja KLANCAR Neza FAIN Katja PINTAR Tjasa		SLO	3:38.52	CR
SILVER	<b>FRANCE</b> TOUATI Assia Anais Nouri TESSARIOL Lucile Lora JEHL Marina CARNEZ Oceane Delphine		FRA	3:41.57	
BRONZE	<b>ITALY</b> LAQUINTANA Sonia MIZZAU Alice SCOTTO DI CARLO Viola MORINI Sofia		ITA	3:42.86	

### 4 x 200m Freestyle Women

GOLD	<b>SLOVENIA</b> SEGEL Janja KLANCAR Neza FAIN Katja PINTAR Tjasa		SLO	7:59.27	
SILVER	<b>ITALY</b> CAPONI Linda CESARANO Antonietta CESARANO Noemi MIZZAU Alice		ITA	7:59.63	
BRONZE	<b>TURKIYE</b> ERTAN Deniz TUNCEL Merve DONMEZ Ecem BOCEKLER Beril		TUR	8:05.41	

### 4 x 100m Medley Women

GOLD	<b>ITALY</b> ZOFKOVA COSTA Carlotta ANGIOLINI Lisa BIANCHI Ilaria MORINI Sofia		ITA	4:04.65	
------	--	--	-----	---------	--

MEDAL	SURNAME & NAME	DATE OF BIRTH	NOC	TIME
SILVER	<b>SPAIN</b> ZAMORANO SANZ Africa GARCIA URZAINQUI Marina HURTADO SIRERA Carla MUNOZ DEL CAMPO Lidon		ESP	4:06.17
BRONZE	<b>TURKIYE</b> AVRAMOVA Ekaterina GUNES Viktoria ERTAN Deniz CAKICI I.Nihan		TUR	4:07.31

### 50m Freestyle Men

GOLD	<b>GKOLOMEEV Kristian</b>		GRE	21.91
SILVER	<b>DE ALMEIDA SILVA Miguel</b>		POR	22.01
BRONZE	<b>SAHNOUNE Oussama</b>		ALG	22.22

### 100m Freestyle Men

GOLD	<b>MEGLI Filippo</b>		ITA	49.00
SILVER	<b>DE MATOS RIBEIRO Diogo</b>		POR	49.02
BRONZE	<b>BORI Alessandro</b>		ITA	49.12

### 200m Freestyle Men

GOLD	<b>MEGLI Filippo</b>		ITA	1:47.33
SILVER	<b>MARKOS Dimitrios</b>		GRE	1:48.11
BRONZE	<b>DOMINGUEZ CALONGE Luis</b>		ESP	1:48.33

### 400m Freestyle Men

GOLD	<b>MARKOS Dimitrios</b>		GRE	3:48.72
SILVER	<b>BOUCHAUT Joris Levy</b>		FRA	3:49.45
BRONZE	<b>DE TULLIO Luca</b>		ITA	3:50.11

### 1500m Freestyle Men

GOLD	<b>BOUCHAUT Joris Levy</b>		FRA	15:10.11
SILVER	<b>MARKOS Dimitrios</b>		GRE	15:11.47
BRONZE	<b>KILAVUZ Mert</b>		TUR	15:15.41

### 50m Backstroke Men

GOLD	<b>STEFANTH Simone</b>		ITA	25.00
SILVER	<b>SEGURA GUTIERREZ Juan</b>		ESP	25.09
BRONZE	<b>MORA Lorenzo</b>		ITA	25.17



### 100m Backstroke Men

GOLD	<b>MAKRYGIANNIS Evangelos</b>	GRE	54.35
SILVER	<b>MORA Lorenzo</b>	ITA	54.50
BRONZE	<b>HUILLE Stanislas Franck</b>	FRA	54.66

### 200m Backstroke Men

GOLD	<b>MORA Lorenzo</b>	ITA	1:57.62
SILVER	<b>RESTIVO Matteo</b>	ITA	1:57.77
BRONZE	<b>BRUN Christophe Pierre</b>	FRA	1:58.40

### 50m Breaststroke Men

GOLD	<b>SCOZZOLI Fabio</b>	ITA	26.97	CR
SILVER	<b>SAKCI H.Emre</b>	TUR	27.00	
BRONZE	<b>STEVENS Peter John</b>	SLO	27.46	

### 100m Breaststroke Men

GOLD	<b>OGRETIR Berkay O.</b>	TUR	1:00.03	CR
SILVER	<b>SAKCI H.Emre</b>	TUR	1:00.19	
BRONZE	<b>PINZUTI Alessandro</b>	ITA	1:00.31	

### 200m Breaststroke Men

GOLD	<b>OGRETIR Berkay O.</b>	TUR	2:11.26
SILVER	<b>MARC Antoine Laurent</b>	FRA	2:12.55
BRONZE	<b>CASTEJON I RAMIREZ Alex</b>	ESP	2:12.60

### 50m Butterfly Men

GOLD	<b>DE MATOS RIBEIRO Diogo</b>	POR	23.38	CR
SILVER	<b>RIVOLTA Matteo</b>	ITA	23.59	
BRONZE	<b>GKOLOMEEV Kristian</b>	GRE	23.61	

### 100m Butterfly Men

GOLD	<b>RIVOLTA Matteo</b>	ITA	51.66	CR
SILVER	<b>SYOUD Jaouad</b>	ALG	52.38	
BRONZE	<b>VALSECCHI Edoardo</b>	ITA	52.53	

### 200m Butterfly Men

GOLD	<b>FARACI Claudio Antonino</b>	ITA	1:57.09
SILVER	<b>VAZAIOS Andreas</b>	GRE	1:57.92
BRONZE	<b>SYOUD Jaouad</b>	ALG	1:58.37

### 200m Individual Medley Men

GOLD	<b>SYOUD Jaouad</b>		<b>ALG</b>	<b>1:58.83</b>
GOLD	<b>VAZAIOS Andreas</b>		<b>GRE</b>	<b>1:58.83</b>
BRONZE	<b>MATTEAZZI Pier Andrea</b>		<b>ITA</b>	<b>2:00.24</b>

### 400m Individual Medley Men

GOLD	<b>MATTEAZZI Pier Andrea</b>		<b>ITA</b>	<b>4:13.83</b>
SILVER	<b>FERS ERZEN Anze</b>		<b>SLO</b>	<b>4:19.63</b>
BRONZE	<b>SARPE Pietro Paolo</b>		<b>ITA</b>	<b>4:20.41</b>

### 4 x 100m Freestyle Men

GOLD	<b>ITALY</b> SERIO Luca BORI Alessandro CARRARO Giovanni MEGLI Filippo		<b>ITA</b>	<b>3:15.77</b>
SILVER	<b>GREECE</b> VAZAIOS Andreas BILAS Stergios Marios GKOLOMEEV Kristian MARKOS Dimitrios		<b>GRE</b>	<b>3:16.64</b>
BRONZE	<b>FRANCE</b> RIHOUX Charles EVEN Mathias HUG-DREYFUS Tom Paul BEROL Julien Arthur		<b>FRA</b>	<b>3:18.04</b>

### 4 x 200m Freestyle Men

GOLD	<b>GREECE</b> MARKOS Dimitrios MAKRYGIANNIS Evangelos STAMOU Konstantinos VAZAIOS Andreas		<b>GRE</b>	<b>7:17.91</b>
SILVER	<b>SPAIN</b> MOLLA YANES Mario QUIJADA ROLDAN Carlos DOMINGUEZ CALONGE Luis MARTINEZ NOVOA Miguel		<b>ESP</b>	<b>7:23.07</b>
BRONZE	<b>TURKIYE</b> UNLU Baturalp FILIZ Batuhan TURAN Efe CELIK Doga		<b>TUR</b>	<b>7:23.67</b>

**4 x 100m Medley Men**

<b>GOLD</b>	<b>ITALY</b> MORA Lorenzo PINZUTI Alessandro RIVOLTA Matteo BORI Alessandro MEGLI Filippo STEFANTH Simone FUSCO Alessandro RESTIVO Matteo		<b>ITA</b>	<b>3:35.77</b>
<b>SILVER</b>	<b>FRANCE</b> CHOUCHAOUI Mathys BIDARD Clement HUILLE Stanislas Franck RIHOUX Charles COMTE Serguei Corentin BRUN Christophe Pierre		<b>FRA</b>	<b>3:36.03</b>
<b>BRONZE</b>	<b>TURKIYE</b> SAKA Berke OGRETIR Berkay O. GURES Umit Can UNLU Baturalp		<b>TUR</b>	<b>3:36.29</b>

# Swimming



## Medal Standings

RANK	NOC	NATION	WOMEN				MEN				MIXED				MEDALS				
			G	S	B	TOT	G	S	B	TOT	G	S	B	TOT	G	S	B	TOT	RNK
1	ITA	ITALY	5	4	7	16	10	3	7	20					15	7	14	36	1
2	GRE	GREECE	1	2		3	5	4	1	10					6	6	1	13	3
3	TUR	TURKIYE	3	3	6	12	2	2	3	7					5	5	9	19	2
4	SLO	SLOVENIA	3	4	1	8		1	1	2					3	5	2	10	4
5	POR	PORTUGAL	2	2	2	6	1	2		3					3	4	2	9	6
6	BIH	BOSNIA AND HERZEGOVINA	2			2									2			2	9
7	ESP	SPAIN	1	3	2	6		2	2	4					1	5	4	10	4
8	FRA	FRANCE		1		1	1	3	3	7					1	4	3	8	7
9	ALG	ALGERIA					1	1	2	4					1	1	2	4	8
10	CYP	CYPRUS	1		1	2									1		1	2	9
11	SRB	SERBIA	1			1									1			1	11
		<b>TOTAL</b>	19	19	19	57	20	18	19	57					39	37	38	114	

# Swimming



## Entry List By Country

CODE	NOC	CODE	SURNAME & NAME	BORN	EVENT	ENTRY TIME
<b>ALB ALBANIA</b>						
	W	3345	<b>DANDE Sara</b>		200m Freestyle	
					400m Freestyle	
					800m Freestyle	
	M	3205	<b>UJKASHEJ Drini</b>		50m Freestyle	
					100m Freestyle	
	M	3189	<b>VOGLI Frenkli</b>		50m Butterfly	
					50m Backstroke	
					100m Backstroke	
					200m Backstroke	
<b>ALG ALGERIA</b>						
	M	20771	<b>ACHOUR TALET Sofiane</b>		200m Freestyle	<b>1:54.52</b>
	M	ALG	<b>ALGERIA</b>		4 x 200m Freestyle	<b>3:27.00</b>
					4 x 100m Freestyle	<b>7:36.00</b>
					4 x 200m Freestyle	<b>3:41.00</b>
	W	ALG	<b>ALGERIA</b>		4 x 100 m Medley	<b>3:53.00</b>
					4 x 100m Freestyle	<b>4:20.00</b>
	M	2046	<b>ARDJOUNE Abdellah</b>		4 x 100 m Medley	<b>25.78</b>
					50m Backstroke	<b>56.67</b>
					100m Backstroke	<b>2:01.00</b>
					200m Backstroke	
	M	2208	<b>BALAMANE Moncef Aymen</b>		4 x 100 m Medley	<b>28.82</b>
					50m Breaststroke	<b>1:03.10</b>
					100m Breaststroke	<b>2:19.60</b>
					200m Breaststroke	
	M	30135	<b>BELKHELLADI Malachy</b>		4 x 100 m Medley	
	M	2230	<b>BENBARA Mehdi-Nazim</b>		4 x 100m Freestyle	<b>23.29</b>
					50m Freestyle	<b>52.18</b>
					100m Freestyle	<b>26.70</b>
					50m Backstroke	
	W	2210	<b>BENCHADLI Jihane</b>		4 x 100m Freestyle	<b>2:24.67</b>
					4 x 100 m Medley	<b>2:25.15</b>
					200m Backstroke	<b>2:25.78</b>
					200m Butterfly	<b>52.54</b>
	M	2215	<b>BENZIDOUN Fares</b>		200m Individual Medley	<b>56.30</b>
					100m Freestyle	
					100m Butterfly	
					4 x 100m Freestyle	
					4 x 200m Freestyle	
	M	2216	<b>BOUZOUIA Youcef</b>		4 x 100 m Medley	<b>29.57</b>
					50m Breaststroke	<b>25.68</b>
					50m Butterfly	
					4 x 100m Freestyle	
	M	2217	<b>CHOUCHAR Ramzi</b>		100m Breaststroke	<b>1:04.82</b>
					200m Breaststroke	<b>2:17.00</b>
					200m Individual Medley	<b>2:06.00</b>
					400m Individual Medley	<b>4:25.00</b>
	M	2218	<b>DJABALLAH Mohamed Anisse</b>		200m Freestyle	<b>1:50.00</b>
					400m Freestyle	<b>3:52.00</b>
					1500m Freestyle	<b>15:50.00</b>
					4 x 200m Freestyle	
	M	2278	<b>KHENDRICHE Lounis</b>		400m Freestyle	<b>4:01.43</b>
					200m Butterfly	<b>2:03.24</b>
					4 x 200m Freestyle	
	W	2224	<b>MEDJAHED Nesrine</b>		50m Freestyle	<b>26.20</b>
					100m Freestyle	<b>58.13</b>
					50m Butterfly	<b>28.32</b>
					4 x 100 m Medley	
	W	2225	<b>MELIH Amel</b>		50m Freestyle	<b>25.34</b>
					100m Freestyle	<b>56.50</b>
					50m Backstroke	<b>29.77</b>
					50m Butterfly	<b>27.87</b>
					4 x 100 m Medley	

CODE NOC	CODE	SURNAME & NAME	BORN	EVENT	ENTRY TIME
	W 2227	<b>MIDOUNI Lilia Sihem</b>		200m Freestyle	<b>2:09.30</b>
				400m Freestyle	<b>4:36.20</b>
				100m Butterfly	<b>1:05.44</b>
	W 2229	<b>NEFSI Hamida Rania</b>		200m Butterfly	<b>2:27.32</b>
				200m Breaststroke	<b>2:38.14</b>
				200m Individual Medley	<b>2:23.67</b>
				400m Individual Medley	<b>5:05.98</b>
	M 2232	<b>SAHNOUNE Oussama</b>		4 x 100 m Medley	
	M 2236	<b>SYOUD Jaouad</b>		50m Freestyle	<b>22.55</b>
				50m Butterfly	<b>24.02</b>
				100m Butterfly	<b>52.08</b>
				200m Butterfly	<b>1:57.88</b>
				200m Individual Medley	<b>1:58.12</b>
				400m Individual Medley	<b>4:19.02</b>
	W 2240	<b>ZITOUNI Imene Kawthar</b>		50m Backstroke	<b>31.20</b>
				100m Backstroke	<b>1:06.00</b>
				200m Backstroke	<b>2:23.03</b>
				400m Individual Medley	<b>5:07.00</b>
				4 x 100 m Medley	
<b>AND ANDORRA</b>					
	M 710	<b>LOMERO ARENAS Tomas</b>		50m Freestyle	
				100m Freestyle	
				50m Butterfly	
				100m Butterfly	
	M 713	<b>PELEGRINA CUEN Patrick</b>		50m Backstroke	
				50m Breaststroke	
				100m Breaststroke	
	W 727	<b>RAMIREZ ABELLA Monica</b>		50m Freestyle	
				50m Backstroke	
	W 729	<b>TUDO CUBELLS Nadia</b>		50m Freestyle	
				100m Freestyle	
				100m Breaststroke	
				200m Breaststroke	
<b>BIH BOSNIA AND HERZEGOVINA</b>					
	W 6936	<b>PUDAR Lana</b>		50m Butterfly	
				100m Butterfly	
				200m Butterfly	<b>2:07.85</b>
<b>CRO CROATIA</b>					
	W 1173	<b>BLAZEVIC Ana</b>		100m Breaststroke	<b>1:09.40</b>
				200m Breaststroke	<b>2:27.72</b>
	M 1177	<b>MARIC Ognjen</b>		100m Backstroke	<b>54.73</b>
				200m Backstroke	<b>2:03.71</b>
	M 15492	<b>SURKOVIC Mario</b>		100m Freestyle	<b>49.98</b>
				200m Individual Medley	<b>2:01.90</b>
<b>CYP CYPRUS</b>					
	W 6795	<b>ANTONIOU Kalia</b>		50m Freestyle	<b>24.94</b>
				100m Freestyle	<b>54.25</b>
				50m Butterfly	<b>28.31</b>
	M CYP	<b>CYPRUS</b>		4 x 100m Freestyle	
				4 x 100 m Medley	
	W CYP	<b>CYPRUS</b>		50m Freestyle	<b>25.81</b>
	W 7067	<b>HADJILOIZOU Anna</b>		100m Freestyle	<b>56.80</b>
	M 6988	<b>IAKOVIDIS Filippou</b>		50m Backstroke	<b>26.17</b>
				100m Backstroke	<b>56.47</b>
				4 x 100m Freestyle	
	M 6996	<b>IAKOVIDIS Markos</b>		50m Freestyle	<b>23.43</b>
				50m Breaststroke	<b>28.22</b>
				4 x 100m Freestyle	
				4 x 100 m Medley	
	M 6938	<b>MANOLI Christos</b>		200m Freestyle	<b>2:09.50</b>
				400m Freestyle	<b>4:03.50</b>
				1500m Freestyle	
				100m Butterfly	<b>57.83</b>
				200m Butterfly	
				4 x 100m Freestyle	
				4 x 100 m Medley	

CODE NOC	CODE	SURNAME & NAME	BORN	EVENT	ENTRY TIME
	M 6903	<b>MOUGIS Sofoklis</b>		50m Backstroke	<b>26.38</b>
				100m Backstroke	<b>56.93</b>
	M 7053	<b>PANARETOS Panayiotis</b>		4 x 100 m Medley	
				50m Breaststroke	<b>28.22</b>
				100m Breaststroke	<b>1:01.70</b>
	M 7004	<b>PANTZIAROS Andreas</b>		4 x 100 m Medley	
				50m Freestyle	<b>23.86</b>
				100m Freestyle	
				4 x 100m Freestyle	
<b>ESP SPAIN</b>					
	M 12560	<b>ARAUZ CONESA Javier</b>		100m Backstroke	<b>55.70</b>
				200m Backstroke	<b>2:00.87</b>
	W 5099	<b>CAMPABADAL Ainhoa</b>		200m Freestyle	<b>2:00.98</b>
				400m Freestyle	<b>4:14.68</b>
				4 x 200m Freestyle	
	M 5103	<b>CASTEJON I RAMIREZ Alex</b>		100m Breaststroke	<b>1:02.74</b>
				200m Breaststroke	<b>2:13.30</b>
				200m Individual Medley	<b>2:04.15</b>
				400m Individual Medley	<b>4:17.60</b>
				4 x 100 m Medley	
	M 5111	<b>DOMINGUEZ CALONGE Luis</b>		100m Freestyle	<b>49.49</b>
				200m Freestyle	<b>1:48.59</b>
				400m Freestyle	<b>3:56.54</b>
				4 x 100m Freestyle	
				4 x 200m Freestyle	
				4 x 100 m Medley	
	M 5112	<b>ESCRITS MANOSA Albert</b>		1500m Freestyle	<b>15:16.00</b>
	W 5116	<b>GARCIA URZAINQUI Marina</b>		50m Breaststroke	<b>31.74</b>
				100m Breaststroke	<b>1:08.57</b>
				200m Breaststroke	<b>2:24.25</b>
				4 x 100 m Medley	
	W 5123	<b>HURTADO SIRERA Carla</b>		50m Butterfly	<b>28.24</b>
				100m Butterfly	<b>1:00.69</b>
				200m Butterfly	<b>2:14.36</b>
				4 x 100 m Medley	
	W 5126	<b>JUSTE SANCHEZ Paula</b>		200m Freestyle	<b>2:01.25</b>
				400m Freestyle	<b>4:13.70</b>
				200m Individual Medley	<b>2:15.15</b>
				400m Individual Medley	<b>4:46.74</b>
				4 x 200m Freestyle	
	M 5130	<b>MARTINEZ NOVOA Miguel</b>		50m Butterfly	<b>24.97</b>
				100m Butterfly	<b>53.90</b>
				200m Butterfly	<b>1:58.81</b>
				4 x 100m Freestyle	
				4 x 200m Freestyle	
	M 5131	<b>MARTOS BACARIZO Manuel</b>		50m Backstroke	<b>25.54</b>
				4 x 100 m Medley	
				4 x 100 m Medley	
	M 5132	<b>MIRA ALBALADEJO Diego</b>		100m Backstroke	<b>55.57</b>
				200m Backstroke	<b>2:00.45</b>
	M 5133	<b>MOLLA YANES Mario</b>		50m Freestyle	<b>22.69</b>
				100m Freestyle	<b>49.62</b>
				200m Freestyle	<b>1:48.92</b>
				50m Butterfly	<b>24.04</b>
				100m Butterfly	<b>52.83</b>
				4 x 100m Freestyle	
				4 x 200m Freestyle	
				4 x 100 m Medley	
	W 5135	<b>MUNOZ DEL CAMPO Lidon</b>		50m Freestyle	<b>24.90</b>
				100m Freestyle	<b>54.52</b>
				50m Backstroke	<b>28.52</b>
				50m Butterfly	<b>26.72</b>
				4 x 100 m Medley	
	W 12561	<b>PUJADAS RUSINOL Julia</b>		100m Butterfly	<b>1:02.49</b>
				200m Butterfly	<b>2:14.08</b>
				4 x 200m Freestyle	
	M 5145	<b>QUIJADA ROLDAN Carlos</b>		400m Freestyle	<b>3:52.51</b>
				4 x 200m Freestyle	

CODE NOC	CODE	SURNAME & NAME	BORN	EVENT	ENTRY TIME
	M 5153	<b>SEGURA GUTIERREZ Juan</b>		50m Freestyle	22.65
				50m Backstroke	25.14
	W ESP	<b>SPAIN</b>		4 x 100m Freestyle	3:41.97
				4 x 200m Freestyle	4:04.84
	M ESP	<b>SPAIN</b>		4 x 100 m Medley	3:41.85
				4 x 200m Freestyle	2:29.10
	W 5156	<b>VAZQUEZ RUIZ Alba</b>		4 x 100 m Medley	2:13.88
				200m Breaststroke	4:42.63
	W 5158	<b>WEILER SASTRE Carmen</b>		400m Individual Medley	25.42
				50m Freestyle	55.10
				100m Freestyle	28.40
				50m Backstroke	1:00.66
				100m Backstroke	2:11.84
	W 5159	<b>ZAMORANO SANZ Africa</b>		200m Backstroke	1:01.06
				100m Backstroke	2:09.76
				200m Backstroke	
				4 x 200m Freestyle	
				4 x 100 m Medley	
<b>FRA FRANCE</b>					
	M 8564	<b>AUBRY David Andre</b>		50m Freestyle	22.62
	M 8566	<b>BEROL Julien Arthur</b>		100m Freestyle	
				50m Butterfly	23.80
				4 x 100m Freestyle	
	M 8577	<b>BIDARD Clement</b>		100m Breaststroke	1:01.46
				200m Individual Medley	2:01.69
				4 x 100 m Medley	
	M 8563	<b>BOUCHAUT Joris Levy</b>		200m Freestyle	1:51.49
				400m Freestyle	3:49.08
				1500m Freestyle	15:06.28
	M 8568	<b>BRUN Christophe Pierre</b>		50m Backstroke	26.93
				200m Backstroke	1:59.72
	W 8570	<b>CARNEZ Oceane Delphine</b>		4 x 100 m Medley	
				200m Freestyle	1:59.70
				4 x 100m Freestyle	
				4 x 200m Freestyle	
	M 8580	<b>CHOUCHAOUI Mathys</b>		50m Backstroke	26.14
				100m Backstroke	55.44
				200m Backstroke	2:00.23
				4 x 100 m Medley	
	M 8601	<b>COMTE Serguei Corentin</b>		50m Butterfly	23.77
				4 x 100 m Medley	
	M 8579	<b>EVEN Mathias</b>		50m Freestyle	22.72
				4 x 100m Freestyle	
	W FRA	<b>FRANCE</b>		4 x 100m Freestyle	3:42.00
				4 x 200m Freestyle	
	M FRA	<b>FRANCE</b>		4 x 100m Freestyle	
				4 x 100 m Medley	3:41.50
	W 8600	<b>GRANGEON Lara</b>		200m Butterfly	2:15.48
				400m Individual Medley	4:45.56
	M 8584	<b>HUG-DREYFUS Tom Paul</b>		200m Freestyle	1:50.53
				4 x 100m Freestyle	
	M 8569	<b>HUILLE Stanislas Franck</b>		100m Backstroke	55.01
				100m Butterfly	52.74
				4 x 100 m Medley	
	W 8576	<b>JEHL Marina</b>		100m Freestyle	55.58
				4 x 100m Freestyle	
				4 x 200m Freestyle	
	M 8581	<b>LE PAPE Thomas Yoann</b>		200m Breaststroke	2:14.45
				400m Individual Medley	4:26.14
	M 11805	<b>MAILLOT Melvin</b>		50m Breaststroke	27.96
	M 8582	<b>MARC Antoine Laurent</b>		100m Breaststroke	1:01.67
				200m Breaststroke	2:13.51
	W 8565	<b>MARCHAND Juliette Marie</b>		100m Butterfly	1:01.60
				200m Butterfly	2:12.78



CODE	NOC	CODE	SURNAME & NAME	BORN	EVENT	ENTRY TIME
M	8573		<b>MARSAU Matthias Ange</b>		200m Butterfly	1:59.27
W	8599		<b>MOREL Emma</b>		50m Backstroke	29.12
					50m Butterfly	26.78
					100m Butterfly	1:00.59
W	8583		<b>PODEVIN Anais Joelle</b>		100m Backstroke	1:02.47
					200m Backstroke	2:13.80
M	8597		<b>REMY Tom Nicolas</b>		200m Butterfly	1:59.75
					200m Individual Medley	2:02.46
					400m Individual Medley	4:20.92
M	8578		<b>RIHOUX Charles</b>		100m Freestyle	49.25
					100m Butterfly	52.75
					4 x 100m Freestyle	
W	8615		<b>SANTAMANS Anna Flora</b>		4 x 100 m Medley	
W	8571		<b>TESSARIOL Lucile Lora</b>		50m Freestyle	25.25
					50m Freestyle	26.05
					100m Freestyle	55.50
					200m Freestyle	2:00.22
					4 x 100m Freestyle	
					4 x 200m Freestyle	
W	8562		<b>TISSANDIE Camille Amelie</b>		400m Freestyle	4:18.25
					200m Individual Medley	2:14.42
					400m Individual Medley	4:45.65
W	8575		<b>TOUATI Assia Anais Nouri</b>		4 x 100m Freestyle	
					4 x 200m Freestyle	
M	8602		<b>VALOUR Julien Laurent</b>		50m Breaststroke	28.04
M	8567		<b>VAN WESTERING Kai</b>			
<b>GRE GREECE</b>						
W	4801		<b>ANGELAKI Chara</b>		50m Breaststroke	31.71
					100m Breaststroke	1:09.41
					200m Breaststroke	2:31.67
					4 x 100 m Medley	
M	11222		<b>BILAS Stergios Marios</b>		50m Freestyle	22.66
					100m Freestyle	49.78
					50m Butterfly	23.79
					4 x 100m Freestyle	
					4 x 100 m Medley	
W	4800		<b>DAMASIOTI Georgia</b>		50m Butterfly	27.02
					100m Butterfly	59.53
					200m Butterfly	2:13.26
W	4787		<b>DRASIDOU Maria Thaleia</b>		50m Freestyle	25.71
					50m Breaststroke	30.88
					100m Breaststroke	1:09.54
M	4789		<b>GIOURTZIDIS Daniil</b>		200m Individual Medley	
					400m Individual Medley	4:20.00
M	4782		<b>GKOLOMEEV Kristian</b>		50m Freestyle	21.70
					50m Butterfly	23.61
					4 x 100m Freestyle	
					4 x 100 m Medley	
W	GRE		<b>GREECE</b>		4 x 100m Freestyle	3:48.30
					4 x 200m Freestyle	8:26.00
					4 x 100 m Medley	4:04.20
M	GRE		<b>GREECE</b>		4 x 100m Freestyle	3:15.74
					4 x 200m Freestyle	7:20.00
					4 x 100 m Medley	3:35.62
W	4798		<b>KLIKOPOULOU Sofia</b>		50m Freestyle	25.85
					100m Freestyle	57.06
					4 x 100 m Medley	
M	4786		<b>MAKRYGIANNIS Evangelos</b>		50m Backstroke	25.45
					100m Backstroke	54.43
					200m Backstroke	1:58.16
					4 x 200m Freestyle	
					4 x 100 m Medley	
M	4780		<b>MARKOS Dimitrios</b>		200m Freestyle	1:48.23
					400m Freestyle	3:49.22
					1500m Freestyle	15:19.73
					4 x 100m Freestyle	
					4 x 200m Freestyle	
M	4784		<b>MERETSOLIAS Konstantinos</b>		50m Breaststroke	27.91
					100m Breaststroke	1:00.83
					200m Breaststroke	2:16.03
					4 x 100 m Medley	

CODE NOC	CODE	SURNAME & NAME	BORN	EVENT	ENTRY TIME
	W 11226	<b>MITSAKOU Chrysoula</b>		100m Freestyle	57.64
				200m Freestyle	2:03.52
				400m Freestyle	4:19.07
	W 14705	<b>MITSAKOU Xanthi</b>		400m Individual Medley	5:03.75
				200m Freestyle	2:02.27
				400m Freestyle	4:19.18
	W 4777	<b>NTOUNTOUNAKI Anna</b>		200m Butterfly	2:18.55
				50m Backstroke	29.20
				100m Backstroke	1:04.60
				50m Butterfly	25.65
				100m Butterfly	57.25
	M 4776	<b>PAPASTAMOS Apostolos</b>		4 x 100 m Medley	
	W 4788	<b>SACHA Ioanna</b>		200m Butterfly	
				50m Backstroke	29.75
				100m Backstroke	1:02.37
				200m Backstroke	2:12.64
				200m Individual Medley	2:17.21
	M 11224	<b>SPANOUKAKIS Georgios</b>		4 x 100 m Medley	
				50m Backstroke	25.97
				100m Backstroke	57.17
	M 4793	<b>STAMOU Konstantinos</b>		4 x 100 m Medley	
				400m Freestyle	4:03.81
				100m Butterfly	52.77
				4 x 200m Freestyle	
	M 11221	<b>THOMOGLLOU Savvas</b>		4 x 100 m Medley	
				50m Breaststroke	28.31
				100m Breaststroke	1:01.10
				200m Breaststroke	2:11.67
	M 4781	<b>VAZAIOS Andreas</b>		100m Freestyle	48.98
				100m Butterfly	53.52
				200m Butterfly	
				200m Individual Medley	1:58.35
				4 x 100m Freestyle	
				4 x 200m Freestyle	

## ITA ITALY

	M 12714	<b>ANDOLFI Gianluca</b>		50m Butterfly	23.99
	W 3893	<b>ANGIOLINI Lisa</b>		50m Breaststroke	31.02
				100m Breaststroke	1:06.82
				200m Breaststroke	2:25.64
	W 3895	<b>BIANCHI Ilaria</b>		4 x 100 m Medley	
				100m Butterfly	58.81
	M 3862	<b>BORI Alessandro</b>		4 x 100 m Medley	
				50m Freestyle	22.55
				100m Freestyle	49.14
				4 x 100m Freestyle	
	W 12912	<b>BOTTAZZO Anita</b>		4 x 100 m Medley	
				50m Breaststroke	31.04
				100m Breaststroke	1:07.59
	M 12911	<b>BRUNO Luca</b>		200m Butterfly	1:59.43
	W 3896	<b>CAPONI Linda</b>		4 x 200m Freestyle	
	W 3897	<b>CARAMIGNOLI Martina Rita</b>		400m Freestyle	4:09.84
				800m Freestyle	8:31.03
	M 12619	<b>CARRARO Giovanni</b>		4 x 100m Freestyle	
	W 12915	<b>CAVAGNOLI Vanessa</b>		200m Breaststroke	2:30.54
	W 3899	<b>CENCI Martina</b>		200m Backstroke	2:13.05
	W 3902	<b>CESARANO Antonietta</b>		400m Freestyle	4:09.72
				4 x 200m Freestyle	
	W 6522	<b>CESARANO Noemi</b>		200m Freestyle	2:00.11
				4 x 200m Freestyle	
	M 3868	<b>CODIA Piero</b>		200m Butterfly	2:10.36
	W 12618	<b>CUSINATO Ilaria</b>		200m Individual Medley	2:14.69
	M 12715	<b>DALU Fabio</b>		1500m Freestyle	15:14.38
	M 3869	<b>DE TULLIO Luca</b>		400m Freestyle	3:48.72
				1500m Freestyle	15:00.36
				4 x 200m Freestyle	
	M 12620	<b>FARACI Claudio Antonino</b>		200m Butterfly	1:58.48
	M 12716	<b>FRANCESCHI Nicolo'</b>		50m Freestyle	22.53

CODE NOC	CODE	SURNAME & NAME	BORN	EVENT	ENTRY TIME
	W 12617	<b>FRANCESCHI Sara</b>		200m Individual Medley	<b>2:11.94</b>
	W 12623	<b>FURFARO Francesca Romana</b>		400m Individual Medley	<b>4:40.13</b>
	M 12628	<b>FUSCO Alessandro</b>		200m Backstroke	<b>2:13.41</b>
				100m Breaststroke	<b>1:01.61</b>
				200m Breaststroke	<b>2:12.27</b>
	W 12913	<b>GASTALDI Anita</b>		4 x 100 m Medley	<b>27.80</b>
				50m Backstroke	<b>1:02.14</b>
	W ITA	<b>ITALY</b>		100m Backstroke	<b>3:40.00</b>
				4 x 100m Freestyle	<b>8:00.00</b>
				4 x 200m Freestyle	<b>4:05.00</b>
	M ITA	<b>ITALY</b>		4 x 100 m Medley	<b>3:15.00</b>
				4 x 100m Freestyle	<b>7:15.00</b>
				4 x 200m Freestyle	<b>3:35.00</b>
	W 12622	<b>LAQUINTANA Sonia</b>		4 x 100 m Medley	<b>26.77</b>
	W 12914	<b>LUTECKA Claudia</b>		50m Butterfly	<b>25.79</b>
	M 3878	<b>MATTEAZZI Pier Andrea</b>		50m Freestyle	<b>2:00.91</b>
				200m Individual Medley	<b>4:15.29</b>
	M 3879	<b>MEGLI Filippo</b>		400m Individual Medley	<b>48.77</b>
				100m Freestyle	<b>1:48.23</b>
				200m Freestyle	
				4 x 100m Freestyle	
				4 x 200m Freestyle	
	W 3923	<b>MIZZAU Alice</b>		4 x 100 m Medley	<b>55.53</b>
				100m Freestyle	<b>1:59.22</b>
				200m Freestyle	
				4 x 200m Freestyle	
	M 3880	<b>MORA Lorenzo</b>		50m Backstroke	<b>25.19</b>
				100m Backstroke	<b>54.58</b>
				200m Backstroke	<b>1:57.71</b>
				4 x 100 m Medley	
	W 12712	<b>MORINI Sofia</b>		100m Freestyle	<b>55.71</b>
				4 x 100 m Medley	
	M 3883	<b>PINZUTI Alessandro</b>		50m Breaststroke	<b>27.81</b>
				100m Breaststroke	<b>1:00.85</b>
				4 x 100 m Medley	
	M 3884	<b>PIZZINI Luca</b>			
	W 3927	<b>POLIERI Alessia</b>		200m Butterfly	<b>2:11.41</b>
	M 3885	<b>PROIETTI COLONNA Alessio</b>		200m Freestyle	<b>1:47.96</b>
				400m Freestyle	<b>3:54.74</b>
				4 x 200m Freestyle	
	M 3886	<b>RESTIVO Matteo</b>		100m Backstroke	<b>54.70</b>
				200m Backstroke	<b>1:57.76</b>
				4 x 100 m Medley	
	M 3887	<b>RIVOLTA Matteo</b>		50m Butterfly	<b>23.88</b>
				100m Butterfly	<b>52.16</b>
				4 x 100 m Medley	
	M 12614	<b>SARPE Pietro Paolo</b>		400m Individual Medley	<b>4:21.77</b>
	W 12713	<b>SCOTTO DI CARLO Viola</b>		50m Freestyle	<b>25.52</b>
				50m Butterfly	<b>26.40</b>
	M 3889	<b>SCOZZOLI Fabio</b>		50m Breaststroke	<b>27.20</b>
	M 12613	<b>SERIO Luca</b>		4 x 100m Freestyle	
	M 12629	<b>SORRISO Giovanni</b>		200m Breaststroke	<b>2:16.83</b>
				200m Individual Medley	<b>2:02.74</b>
	M 6531	<b>STEFANTH Simone</b>		50m Backstroke	<b>25.07</b>
				4 x 100 m Medley	
	W 12624	<b>TARZIA Claudia</b>		100m Butterfly	<b>59.74</b>
	W 12625	<b>TETTAMANZI Alisia</b>		800m Freestyle	<b>8:40.40</b>
	W 12626	<b>TONI Carlotta</b>		400m Individual Medley	<b>4:44.69</b>
	M 12621	<b>VALSECCHI Edoardo</b>		100m Butterfly	<b>52.71</b>
	W 3932	<b>ZOFKOVA COSTA Carlotta</b>		50m Backstroke	<b>29.12</b>
				100m Backstroke	<b>1:01.43</b>
				4 x 100 m Medley	
	M 3892	<b>ZUIN Mattia</b>		4 x 200m Freestyle	
<b>KOS KOSOVO</b>					
	W 12406	<b>BEKA Vanesa</b>		50m Breaststroke	<b>37.41</b>
				100m Breaststroke	<b>1:23.99</b>
	M 12409	<b>TELAKU Alush</b>		50m Butterfly	<b>26.68</b>
				100m Butterfly	
				200m Butterfly	<b>2:07.93</b>

CODE NOC	CODE	SURNAME & NAME	BORN	EVENT	ENTRY TIME
<b>LBA LIBYA</b>					
	M 7056	<b>AL SHARIF Siraj</b>		100m Freestyle	
	M 7052	<b>ASHOUR Abdulhay</b>		200m Butterfly	
				200m Freestyle	
				400m Freestyle	
<b>MKD NORTH MACEDONIA</b>					
	M 13942	<b>STOJANOVSKI Andrej</b>		50m Backstroke	27.74
				200m Breaststroke	2:24.79
<b>MON MONACO</b>					
	M 7131	<b>DRUENNE Theo</b>		400m Freestyle	
				1500m Freestyle	15:54.79
	W 7132	<b>VERDINO Claudia</b>		50m Breaststroke	
				100m Breaststroke	1:14.42
<b>POR PORTUGAL</b>					
	M 9759	<b>ALMEIDA LOPES Gabriel</b>		200m Freestyle	1:54.50
				100m Breaststroke	1:03.50
				200m Breaststroke	2:19.70
				200m Individual Medley	1:58.60
				4 x 100 m Medley	
	W 9773	<b>AMADO GOMES Rafaela</b>		50m Backstroke	28.20
				100m Backstroke	1:01.30
	W 9744	<b>CUNHA Ana</b>		100m Butterfly	1:00.50
				200m Butterfly	2:09.80
	M 9770	<b>DE ALMEIDA SILVA Miguel</b>		50m Freestyle	22.20
				100m Freestyle	49.10
				50m Butterfly	23.50
				100m Butterfly	
				4 x 100m Freestyle	
				4 x 100 m Medley	
	M 9753	<b>DE MATOS RIBEIRO Diogo</b>		50m Freestyle	22.40
				100m Freestyle	48.70
				50m Butterfly	23.30
				100m Butterfly	52.30
				4 x 100m Freestyle	
				4 x 100 m Medley	
	M 9757	<b>DE OLIVEIRA Francisco</b>		50m Breaststroke	28.50
				100m Breaststroke	1:01.60
				200m Breaststroke	
				4 x 100 m Medley	
	W 9743	<b>DE PINHO RODRIGUES Ana</b>		100m Freestyle	57.80
				50m Breaststroke	31.20
				100m Breaststroke	1:08.80
				4 x 100 m Medley	
	W 15320	<b>FREITAS GUEDES Ana</b>		50m Freestyle	26.40
				50m Butterfly	26.60
	W 9774	<b>GOMES RAMOS Raquel</b>		200m Breaststroke	2:26.60
				400m Individual Medley	4:47.90
	W 9778	<b>HOLUB Tamila Hryhorivna</b>		200m Freestyle	2:02.60
				400m Freestyle	4:11.90
				800m Freestyle	8:32.30
				4 x 200m Freestyle	
	M 9742	<b>MANACAS SILVA Alexis</b>		50m Backstroke	22.20
				50m Breaststroke	28.40
				200m Individual Medley	1:59.10
	M 9765	<b>NOGUEIRA DA COSTA Joao</b>		50m Backstroke	25.50
				100m Backstroke	53.90
				200m Backstroke	1:58.60
				4 x 100m Freestyle	
				4 x 100 m Medley	
	W 9768	<b>PACHECO DE SOUSA Mariana</b>		50m Butterfly	27.10
				100m Butterfly	1:00.10
				200m Butterfly	2:13.50
				4 x 200m Freestyle	
				4 x 100 m Medley	
				4 x 100m Freestyle	
				4 x 200m Freestyle	
				4 x 100 m Medley	
	W POR	<b>PORTUGAL</b>		4 x 100m Freestyle	

CODE NOC	CODE	SURNAME & NAME	BORN	EVENT	ENTRY TIME
	M POR	<b>PORTUGAL</b>		4 x 100m Freestyle	
	W 9749	<b>RODRIGUES REBELO Camila</b>		4 x 100 m Medley	
				50m Backstroke	28.80
				100m Backstroke	1:01.10
				200m Backstroke	2:11.20
	M 9758	<b>SANTOS Francisco</b>		4 x 200m Freestyle	
				4 x 100 m Medley	
				100m Backstroke	54.40
				200m Backstroke	1:57.10
	W 9756	<b>SOARES MARTINS Francisca</b>		4 x 100m Freestyle	
				4 x 100 m Medley	
				50m Freestyle	26.70
				100m Freestyle	56.90
				200m Freestyle	2:01.90
				400m Freestyle	4:15.80
				4 x 200m Freestyle	
				4 x 100 m Medley	
<b>SLO SLOVENIA</b>					
	M 12124	<b>BOSKAN Saso</b>		200m Freestyle	1:49.80
				400m Freestyle	3:56.60
				50m Backstroke	25.80
				100m Backstroke	55.90
				4 x 100 m Medley	
	W 12113	<b>FAIN Katja</b>		200m Freestyle	1:57.83
				400m Freestyle	4:09.73
	M 12107	<b>FERS ERZEN Anze</b>		4 x 200m Freestyle	
				200m Backstroke	2:00.96
				200m Individual Medley	2:02.20
				400m Individual Medley	4:27.70
				4 x 100 m Medley	
	W 12118	<b>KLANCAR Neza</b>		50m Freestyle	24.96
				100m Freestyle	54.50
				50m Butterfly	26.40
				4 x 200m Freestyle	
				4 x 100 m Medley	
	W 12128	<b>PINTAR Tjasa</b>		50m Freestyle	26.08
				50m Breaststroke	32.30
				100m Breaststroke	1:11.30
				4 x 200m Freestyle	
				4 x 100 m Medley	
	W 12112	<b>SEGEL Janja</b>		100m Freestyle	54.30
				200m Freestyle	1:58.40
				100m Backstroke	1:02.40
				4 x 200m Freestyle	
				4 x 100 m Medley	
	M 12122	<b>SENICA PAVLETIC Primoz</b>		100m Backstroke	56.80
				200m Backstroke	1:59.79
				4 x 100 m Medley	
	M SLO	<b>SLOVENIA</b>		4 x 100 m Medley	3:43.51
	W SLO	<b>SLOVENIA</b>		4 x 100m Freestyle	3:49.61
				4 x 200m Freestyle	
				4 x 100 m Medley	4:09.78
	M 12121	<b>STEVENS Peter John</b>		50m Breaststroke	27.30
				100m Breaststroke	1:02.10
				4 x 100 m Medley	
	W 12108	<b>TUSEK Dasa</b>		400m Freestyle	4:17.95
				800m Freestyle	8:53.40
	W 12125	<b>VOVK Tara</b>		50m Breaststroke	31.10
				100m Breaststroke	1:08.90
				4 x 100 m Medley	
<b>SMR SAN MARINO</b>					
	M 1926	<b>BIANCHI Loris</b>		200m Freestyle	1:54.17
				400m Freestyle	3:59.54
				1500m Freestyle	15:56.47
	M 1928	<b>CASADEI Giacomo</b>		50m Breaststroke	29.59
				100m Breaststroke	1:04.70
				200m Breaststroke	2:19.81

CODE NOC	CODE	SURNAME & NAME	BORN	EVENT	ENTRY TIME
	M 5051	<b>REBOSIO Alessandro</b>		50m Butterfly 100m Butterfly 200m Butterfly	<b>25.65</b> <b>56.42</b> <b>2:06.18</b>
<b>SRB SERBIA</b>	M 6066	<b>ACIN Nikola</b>		50m Freestyle 100m Freestyle	<b>22.51</b> <b>49.42</b>
	W 6053	<b>CREVAR Anja</b>			
	M 6067	<b>MATIC Durde</b>		50m Butterfly 100m Butterfly	<b>24.31</b> <b>53.30</b>
	M 6063	<b>NIKOLIC Uros</b>		50m Freestyle 100m Freestyle	<b>22.66</b> <b>49.59</b>
	W 6054	<b>POPOVIC Tanja</b>			
	M 6062	<b>RATKOV Nikola</b>			
	W 6055	<b>STANISAVLJEVIC Nina</b>		50m Freestyle 100m Freestyle 50m Backstroke 50m Butterfly	<b>25.16</b> <b>55.21</b> <b>28.54</b> <b>27.38</b>
<b>TUN TUNISIA</b>	M 13831	<b>JOUADI Ahmed</b>		400m Freestyle 1500m Freestyle	<b>4:52.44</b> <b>15:15.30</b>
	M 13827	<b>LAGILI Mohamed Mehdi</b>		200m Freestyle 400m Freestyle	<b>1:48.12</b> <b>4:47.86</b>
<b>TUR TURKIYE</b>	W 10879	<b>AVRAMOVA Ekaterina</b>		100m Freestyle 50m Backstroke 100m Backstroke 200m Backstroke 4 x 100 m Medley	<b>55.85</b> <b>28.57</b> <b>1:00.48</b> <b>2:12.32</b> <b>1:59.73</b>
	W 10864	<b>BOCEKLER Beril</b>		200m Freestyle 400m Freestyle 4 x 200m Freestyle	<b>4:08.27</b> <b>4:08.27</b> <b>4:08.27</b>
	W 10890	<b>CAKICI I.Nihan</b>		50m Freestyle 100m Freestyle 4 x 100 m Medley	<b>26.07</b> <b>56.32</b> <b>50.37</b>
	M 10872	<b>CELIK Doga</b>		100m Freestyle 4 x 100m Freestyle 4 x 200m Freestyle	<b>50.37</b> <b>50.37</b> <b>50.37</b>
	W 10915	<b>DENIZLI Sudem</b>		200m Backstroke	<b>2:12.31</b>
	W 10944	<b>DONMEZ Ecem</b>		50m Butterfly 4 x 200m Freestyle	<b>27.90</b> <b>27.90</b>
	W 10952	<b>ELIGUL Sezin</b>		50m Freestyle 50m Backstroke 50m Butterfly	<b>26.10</b> <b>28.90</b> <b>27.20</b>
	W 10942	<b>ERTAN Deniz</b>		400m Freestyle 800m Freestyle 200m Individual Medley 400m Individual Medley 4 x 200m Freestyle 4 x 100 m Medley	<b>4:08.18</b> <b>8:32.14</b> <b>2:16.20</b> <b>4:40.45</b> <b>4:40.45</b> <b>3:50.53</b>
	M 10862	<b>FILIZ Batuhan</b>		400m Freestyle 1500m Freestyle 4 x 200m Freestyle	<b>15:27.80</b> <b>15:27.80</b> <b>15:27.80</b>
	W 10919	<b>GUNES Viktoria</b>		50m Breaststroke 100m Breaststroke 200m Breaststroke 200m Individual Medley 400m Individual Medley 4 x 100 m Medley	<b>31.71</b> <b>1:08.25</b> <b>2:26.01</b> <b>2:12.37</b> <b>4:46.85</b> <b>4:46.85</b>
	M 10928	<b>GURDENLI Emre</b>		50m Freestyle 4 x 100m Freestyle	<b>22.82</b> <b>22.82</b>
	M 10937	<b>GURES Umit Can</b>		50m Butterfly 100m Butterfly 4 x 100 m Medley	<b>23.67</b> <b>51.91</b> <b>51.91</b>
	M 10932	<b>KILAVUZ Mert</b>		1500m Freestyle	<b>15:02.22</b>
	M 10892	<b>KORKMAZ Kaan</b>		200m Breaststroke 200m Individual Medley 400m Individual Medley	<b>2:19.16</b> <b>2:04.21</b> <b>4:23.93</b>

CODE	NOC	CODE	SURNAME & NAME	BORN	EVENT	ENTRY TIME
M	10866		<b>OGRETIR Berkay O.</b>		50m Breaststroke	<b>27.63</b>
					100m Breaststroke	<b>59.23</b>
					200m Breaststroke	<b>2:09.87</b>
M	10867		<b>SAKA Berke</b>		4 x 100 m Medley	
					100m Backstroke	<b>54.91</b>
					200m Backstroke	<b>1:57.36</b>
					200m Individual Medley	<b>2:00.04</b>
M	10929		<b>SAKCI H.Emre</b>		4 x 100 m Medley	
					50m Freestyle	<b>22.59</b>
					100m Freestyle	<b>49.96</b>
					50m Breaststroke	<b>26.83</b>
					100m Breaststroke	<b>59.87</b>
					50m Butterfly	<b>24.16</b>
					4 x 100m Freestyle	
W	10870		<b>TACYILDIZ Defne</b>		100m Butterfly	<b>1:01.44</b>
					200m Butterfly	<b>2:09.82</b>
M	10875		<b>TEKIN Doruk</b>		50m Backstroke	<b>25.37</b>
W	10904		<b>TUNCEL Merve</b>		200m Freestyle	<b>1:59.71</b>
					800m Freestyle	<b>8:21.91</b>
					200m Butterfly	<b>2:11.54</b>
					4 x 200m Freestyle	
M	10877		<b>TURAN Efe</b>		200m Freestyle	<b>1:50.31</b>
					400m Freestyle	<b>3:50.95</b>
					4 x 200m Freestyle	
M	TUR		<b>TURKIYE</b>		4 x 100m Freestyle	<b>3:18.40</b>
					4 x 200m Freestyle	<b>7:17.20</b>
					4 x 100 m Medley	<b>3:35.10</b>
W	TUR		<b>TURKIYE</b>		4 x 100m Freestyle	<b>3:42.00</b>
					4 x 200m Freestyle	<b>8:00.90</b>
					4 x 100 m Medley	<b>4:04.00</b>
M	10910		<b>TURNALI Polat Uzer</b>		100m Butterfly	<b>55.05</b>
					200m Butterfly	<b>2:00.46</b>
					400m Individual Medley	<b>4:28.19</b>
M	10925		<b>UNLU Baturalp</b>		200m Freestyle	<b>1:47.20</b>
					4 x 100m Freestyle	
					4 x 200m Freestyle	
					4 x 100 m Medley	



# Swimming



## Results

RANK LANE SURNAME & NAME NOC BORN R.T. TIME GAP FINA PTS

### Event 25

04/07/2022 - 18:03

### 50m Freestyle Men Final

WR	20.91	CIELO CESAR	BRA	2009
CR	21.17	FREDERICK BOUSQUET	FRA	2009
JR	21.83	SELIN ARTEM	GER	2019

### Final

RANK	LANE	SURNAME & NAME	NOC	BORN	R.T.	TIME	GAP	FINA PTS
1	4	GKOLOMEEV Kristian	GRE		0.68	<b>21.91</b>		
2	6	DE ALMEIDA SILVA Miguel	POR		0.63	<b>22.01</b>	0.10	
3	5	SAHNOUNE Oussama	ALG		0.66	<b>22.22</b>	0.31	
4	1	SAKCI H.Emre	TUR		0.63	<b>22.37</b>	0.46	
5	3	DE MATOS RIBEIRO Diogo	POR		0.62	<b>22.40</b>	0.49	
6	7	BORI Alessandro	ITA		0.64	<b>22.50</b>	0.59	
7	8	BEROL Julien Arthur	FRA		0.64	<b>22.65</b>	0.74	
8	2	BILAS Stergios Marios	GRE		0.67	<b>22.75</b>	0.84	

Issued: 04/07/2022 at 18:07





# Swimming



## Results

Event 25  
04/07/2022 - 10:10

### 50m Freestyle Men Preliminary

RANK	LANE	SURNAME & NAME	NOC	BORN	R.T.	TIME	GAP	FINA PTS
WR	20.91	CIELO CESAR	BRA					2009
CR	21.17	FREDERICK BOUSQUET	FRA					2009
JR	21.83	SELIN ARTEM	GER					2019

#### Heat 1 of 3

1	5	SAHNOUNE Oussama	ALG		0.62	22.13		q
2	4	DE MATOS RIBEIRO Diogo	POR		0.64	22.52	0.39	q
3	6	BILAS Stergios Marios	GRE		0.66	22.62	0.49	q
4	3	BEROL Julien Arthur	FRA		0.62	22.68	0.55	q
5	2	GURDENLI Emre	TUR		0.62	22.70	0.57	R?
6	7	PANTZIAROS Andreas	CYP		0.70	24.88	2.75	

Issued: 04/07/2022 at 10:09

#### Heat 2 of 3

1	4	DE ALMEIDA SILVA Miguel	POR		0.60	22.55		q
2	3	SAKCI H.Emre	TUR		0.63	22.65	0.10	q
3	5	FRANCESCHI Nicolo'	ITA		0.68	22.69	0.14	R1
4	2	EVEN Mathias	FRA		0.68	22.70	0.15	R?
5	6	NIKOLIC Uros	SRB		0.65	22.80	0.25	
6	7	IAKOVIDIS Markos	CYP		0.68	23.80	1.25	
7	1	LOMERO ARENAS Tomas	AND		0.58	23.83	1.28	

Issued: 04/07/2022 at 10:12

#### Heat 3 of 3

1	4	GKOLOMEEV Kristian	GRE		0.72	22.05		q
2	3	BORI Alessandro	ITA		0.64	22.63	0.58	q
3	5	ACIN Nikola	SRB		0.66	22.73	0.68	
4	6	SEGURA GUTIERREZ Juan	ESP		0.61	22.91	0.86	
5	2	MOLLA YANES Mario	ESP		0.63	23.39	1.34	
6	7	BENBARA Mehdi-Nazim	ALG		0.63	23.46	1.41	
7	1	UJKASHEJ Drini	ALB		0.69	27.11	5.06	

Issued: 04/07/2022 at 10:15



# Swimming



## Results

RANK	LANE	SURNAME & NAME	NOC	BORN	R.T.	TIME	GAP	FINA PTS
------	------	----------------	-----	------	------	------	-----	-------------

### Event 25

04/07/2022 - 11:10

### 50m Freestyle Men Swim-Off

WR	20.91	CIELO CESAR	BRA	2009
CR	21.17	FREDERICK BOUSQUET	FRA	2009
JR	21.83	SELIN ARTEM	GER	2019

### Swim-Off

1	4	EVEN Mathias	FRA	0.67	<b>22.66</b>			R2
2	5	GURDENLI Emre	TUR	0.64	<b>22.75</b>	0.09		

Issued: 04/07/2022 at 11:09



# Swimming



## Results

RANK HEAT LANE SURNAME & NAME NOC BORN R.T. TIME GAP FINA PTS

### Event 25

04/07/2022 - 10:10

### 50m Freestyle Men Preliminary

WR	20.91	CIELO CESAR	BRA	2009
CR	21.17	FREDERICK BOUSQUET	FRA	2009
JR	21.83	SELIN ARTEM	GER	2019

RANK	HEAT	LANE	SURNAME & NAME	NOC	BORN	R.T.	TIME	GAP	FINA PTS
1	3	4	GKOLOMEEV Kristian	GRE		0.72	<b>22.05</b>		q
2	1	5	SAHNOUNE Oussama	ALG		0.62	<b>22.13</b>	0.08	q
3	1	4	DE MATOS RIBEIRO Diogo	POR		0.64	<b>22.52</b>	0.47	q
4	2	4	DE ALMEIDA SILVA Miguel	POR		0.60	<b>22.55</b>	0.50	q
5	1	6	BILAS Stergios Marios	GRE		0.66	<b>22.62</b>	0.57	q
6	3	3	BORI Alessandro	ITA		0.64	<b>22.63</b>	0.58	q
7	2	3	SAKCI H.Emre	TUR		0.63	<b>22.65</b>	0.60	q
8	1	3	BEROL Julien Arthur	FRA		0.62	<b>22.68</b>	0.63	q
9	2	5	FRANCESCHI Nicolo'	ITA		0.68	<b>22.69</b>	0.64	R1
10	2	2	EVEN Mathias	FRA		0.68	<b>22.70</b>	0.65	R?
10	1	2	GURDENLI Emre	TUR		0.62	<b>22.70</b>	0.65	R?
12	3	5	ACIN Nikola	SRB		0.66	<b>22.73</b>	0.68	
13	2	6	NIKOLIC Uros	SRB		0.65	<b>22.80</b>	0.75	
14	3	6	SEGURA GUTIERREZ Juan	ESP		0.61	<b>22.91</b>	0.86	
15	3	2	MOLLA YANES Mario	ESP		0.63	<b>23.39</b>	1.34	
16	3	7	BENBARA Mehdi-Nazim	ALG		0.63	<b>23.46</b>	1.41	
17	2	7	IAKOVIDIS Markos	CYP		0.68	<b>23.80</b>	1.75	
18	2	1	LOMERO ARENAS Tomas	AND		0.58	<b>23.83</b>	1.78	
19	1	7	PANTZIAROS Andreas	CYP		0.70	<b>24.88</b>	2.83	
20	3	1	UJKASHEJ Drini	ALB		0.69	<b>27.11</b>	5.06	

Issued: 04/07/2022 at 10:15



# Swimming



## Results

RANK	LANE	SURNAME & NAME	NOC	BORN	R.T.	50m	TIME	GAP	FINA PTS
------	------	----------------	-----	------	------	-----	------	-----	-------------

Event 12  
02/07/2022 - 18:32

### 100m Freestyle Men Final

WR	46.91	CIELO CESAR			BRA				2009
CR	47.83	Alain BERNARD			FRA				2009
WJ	47.57	MIKANOV ANDREI			RUS				2020

### Final

1	5	MEGLI Filippo	ITA		0.66	23.77	<b>49.00</b> 25.23		
2	2	DE MATOS RIBEIRO Diogo	POR		0.66	23.74	<b>49.02</b> 25.28	0.02	
3	3	BORI Alessandro	ITA		0.65	23.54	<b>49.12</b> 25.58	0.12	
4	4	RIHOUX Charles	FRA		0.70	23.48	<b>49.15</b> 25.67	0.15	
5	6	VAZAIOS Andreas	GRE		0.63	24.41	<b>49.50</b> 25.09	0.50	
6	1	DOMINGUEZ CALONGE Luis	ESP		0.76	23.79	<b>49.82</b> 26.03	0.82	
7	7	NIKOLIC Uros	SRB		0.77	23.99	<b>49.85</b> 25.86	0.85	
8	8	SURKOVIC Mario	CRO		0.74	24.03	<b>50.61</b> 26.58	1.61	

Issued: 02/07/2022 at 18:40



# Swimming



## Results

Event 12  
02/07/2022 - 10:30

### 100m Freestyle Men Preliminary

RANK	LANE	SURNAME & NAME	NOC	BORN	R.T.	50m	TIME	GAP	FINA PTS
WR	46.91	CIELO CESAR	BRA						2009
CR	47.83	Alain BERNARD	FRA						2009
WJ	47.57	MIKANOV ANDREI	RUS						2020

#### Heat 1 of 3

1	6	RIHOUX Charles	FRA		0.65	23.39	<b>48.58</b> 25.19		q
2	5	VAZAIOS Andreas	GRE		0.59	24.62	<b>49.62</b> 25.00	1.04	q
3	4	NIKOLIC Uros	SRB		0.67	24.22	<b>49.78</b> 25.56	1.20	q
4	3	BEROL Julien Arthur	FRA		0.65	24.38	<b>50.56</b> 26.18	1.98	
5	7	BENZIDOUN Fares	ALG		0.68	25.03	<b>52.48</b> 27.45	3.90	
6	1	AL SHARIF Siraj	LBA		0.63	27.48	<b>56.89</b> 29.41	8.31	
7	2	UJKASHEJ Drini	ALB		0.69	28.18	<b>59.37</b> 31.19	10.79	

Issued: 02/07/2022 at 10:37

#### Heat 2 of 3

1	4	MEGLI Filippo	ITA		0.66	23.83	<b>49.18</b> 25.35		q
2	5	BORI Alessandro	ITA		0.67	24.01	<b>49.45</b> 25.44	0.27	q
3	3	DOMINGUEZ CALONGE Luis	ESP		0.73	23.92	<b>49.81</b> 25.89	0.63	q
4	2	SURKOVIC Mario	CRO		0.70	23.51	<b>49.82</b> 26.31	0.64	q
5	6	BILAS Stergios Marios	GRE		0.71	23.82	<b>50.23</b> 26.41	1.05	
6	7	BENBARA Mehdi-Nazim	ALG		0.62	24.11	<b>52.78</b> 28.67	3.60	
7	1	PANTZIAROS Andreas	CYP		0.67	26.16	<b>55.07</b> 28.91	5.89	

Issued: 02/07/2022 at 10:40

#### Heat 3 of 3

1	4	DE MATOS RIBEIRO Diogo	POR			23.92	<b>49.66</b> 25.74		q
2	6	MOLLA YANES Mario	ESP		0.64	23.99	<b>50.06</b> 26.07	0.40	R1
3	5	DE ALMEIDA SILVA Miguel	POR		0.64	23.90	<b>50.10</b> 26.20	0.44	R2
4	3	ACIN Nikola	SRB			24.12	<b>50.30</b> 26.18	0.64	



# Swimming



## Results

RANK	LANE	SURNAME & NAME	NOC	BORN	R.T.	TIME	GAP	FINA PTS
5	2	SAKCI H.Emre	TUR			24.56 <b>50.97</b> 26.41	1.31	
6	7	CELIK Doga	TUR		0.67	24.56 <b>51.20</b> 26.64	1.54	
7	1	LOMERO ARENAS Tomas	AND			24.67 <b>51.86</b> 27.19	2.20	

Issued: 02/07/2022 at 10:44



# Swimming



## Results

RANK HEAT LANE SURNAME & NAME NOC BORN R.T. 50m TIME GAP FINA PTS

### Event 12

02/07/2022 - 10:30

### 100m Freestyle Men Preliminary

WR	46.91	CIELO CESAR	BRA	2009
CR	47.83	Alain BERNARD	FRA	2009
WJ	47.57	MIKANOV ANDREI	RUS	2020

1	1	6	RIHOUX Charles	FRA	0.65	23.39	<b>48.58</b> 25.19		q
2	2	4	MEGLI Filippo	ITA	0.66	23.83	<b>49.18</b> 25.35	0.60	q
3	2	5	BORI Alessandro	ITA	0.67	24.01	<b>49.45</b> 25.44	0.87	q
4	1	5	VAZAIOS Andreas	GRE	0.59	24.62	<b>49.62</b> 25.00	1.04	q
5	3	4	DE MATOS RIBEIRO Diogo	POR		23.92	<b>49.66</b> 25.74	1.08	q
6	1	4	NIKOLIC Uros	SRB	0.67	24.22	<b>49.78</b> 25.56	1.20	q
7	2	3	DOMINGUEZ CALONGE Luis	ESP	0.73	23.92	<b>49.81</b> 25.89	1.23	q
8	2	2	SURKOVIC Mario	CRO	0.70	23.51	<b>49.82</b> 26.31	1.24	q
9	3	6	MOLLA YANES Mario	ESP	0.64	23.99	<b>50.06</b> 26.07	1.48	R1
10	3	5	DE ALMEIDA SILVA Miguel	POR	0.64	23.90	<b>50.10</b> 26.20	1.52	R2
11	2	6	BILAS Stergios Marios	GRE	0.71	23.82	<b>50.23</b> 26.41	1.65	
12	3	3	ACIN Nikola	SRB		24.12	<b>50.30</b> 26.18	1.72	
13	1	3	BEROL Julien Arthur	FRA	0.65	24.38	<b>50.56</b> 26.18	1.98	
14	3	2	SAKCI H.Emre	TUR		24.56	<b>50.97</b> 26.41	2.39	
15	3	7	CELIK Doga	TUR	0.67	24.56	<b>51.20</b> 26.64	2.62	
16	3	1	LOMERO ARENAS Tomas	AND		24.67	<b>51.86</b> 27.19	3.28	
17	1	7	BENZIDOUN Fares	ALG	0.68	25.03	<b>52.48</b> 27.45	3.90	
18	2	7	BENBARA Mehdi-Nazim	ALG	0.62	24.11	<b>52.78</b> 28.67	4.20	
19	2	1	PANTZIAROS Andreas	CYP	0.67	26.16	<b>55.07</b> 28.91	6.49	
20	1	1	AL SHARIF Siraj	LBA	0.63	27.48	<b>56.89</b> 29.41	8.31	
21	1	2	UJKASHEJ Drini	ALB	0.69	28.18	<b>59.37</b> 31.19	10.79	

Issued: 02/07/2022 at 10:44



# Swimming



## Results

Event 33  
05/07/2022 - 18:20

### 200m Freestyle Men Final

WR	1:42.00	BIEDERMANN PAUL	GER	2009
CR	1:46.44	OUSSAMA MELLOULI	TUN	2009
JR	1:44.62	HWANG SUN WOO	KOR	2021

### Final

RANK	LANE	SURNAME & NAME	NOC	BORN	R.T.	50m	100m	150m	TIME	GAP	FINA PTS
1	4	MEGLI Filippo	ITA	0.65	24.58	51.46 26.88	1:19.05 27.59	<b>1:47.33</b> 28.28			
2	8	MARKOS Dimitrios	GRE	0.71	25.97	53.56 27.59	1:20.65 27.09	<b>1:48.11</b> 27.46	0.78		
3	5	DOMINGUEZ CALONGE Luis	ESP	0.72	24.94	52.17 27.23	1:20.69 28.52	<b>1:48.33</b> 27.64	1.00		
4	6	PROIETTI COLONNA Alessio	ITA	0.65	25.51	52.84 27.33	1:20.77 27.93	<b>1:48.61</b> 27.84	1.28		
5	3	UNLU Baturalp	TUR	0.67	25.23	52.60 27.37	1:20.83 28.23	<b>1:49.11</b> 28.28	1.78		
6	2	BOSKAN Saso	SLO	0.62	25.74	52.97 27.23	1:20.99 28.02	<b>1:49.15</b> 28.16	1.82		
7	7	BOUCHAUT Joris Levy	FRA	0.72	26.13	53.67 27.54	1:21.35 27.68	<b>1:49.54</b> 28.19	2.21		
8	1	TURAN Efe	TUR	0.68	25.93	54.41 28.48	1:22.75 28.34	<b>1:51.68</b> 28.93	4.35		

Issued: 05/07/2022 at 18:28





## Results

### Event 33

05/07/2022 - 10:40

WR	1:42.00	BIEDERMANN PAUL	GER	2009
CR	1:46.44	OUSSAMA MELLOULI	TUN	2009
JR	1:44.62	HWANG SUN WOO	KOR	2021

### Heat 1 of 3

1	5	DOMINGUEZ CALONGE Luis	ESP	0.71	25.49	52.96 27.47	1:21.29 28.33	<b>1:49.10</b> 27.81		q
2	6	BOUCHAUT Joris Levy	FRA	0.73	26.27	53.73 27.46	1:21.77 28.04	<b>1:50.12</b> 28.35	1.02	q
3	4	LAGILI Mohamed Mehdi	TUN	0.78	25.96	53.80 27.84	1:22.99 29.19	<b>1:53.46</b> 30.47	4.36	
4	3	DJABALLAH Mohamed Anisse	ALG	0.73	26.55	55.16 28.61	1:23.79 28.63	<b>1:53.69</b> 29.90	4.59	
5	2	ACHOUR TALET Sofiane	ALG	0.63	27.13	55.55 28.42	1:24.42 28.87	<b>1:53.94</b> 29.52	4.84	

Issued: 05/07/2022 at 10:28

### Heat 2 of 3

1	4	PROIETTI COLONNA Alessio	ITA	0.64	25.78	53.31 27.53	1:21.40 28.09	<b>1:49.94</b> 28.54		q
2	3	BOSKAN Saso	SLO	0.62	26.29	54.55 28.26	1:22.88 28.33	<b>1:50.08</b> 27.20	0.14	q
3	5	MARKOS Dimitrios	GRE	0.71	26.03	54.07 28.04	1:22.48 28.41	<b>1:51.10</b> 28.62	1.16	q
4	2	ALMEIDA LOPES Gabriel	POR	0.61	26.90	55.20 28.30	1:23.58 28.38	<b>1:52.37</b> 28.79	2.43	R1
5	6	HUG-DREYFUS Tom Paul	FRA	0.65	26.80	55.75 28.95	1:24.65 28.90	<b>1:53.40</b> 28.75	3.46	R2
6	7	ASHOUR Abdulhay	LBA	0.74	28.63	59.80 31.17	1:31.89 32.09	<b>2:03.53</b> 31.64	13.59	

Issued: 05/07/2022 at 10:33

### Heat 3 of 3

1	5	MEGLI Filippo	ITA	0.65	25.12	52.02 26.90	1:19.81 27.79	<b>1:48.08</b> 28.27		q
2	4	UNLU Baturalp	TUR	0.68	25.80	53.35 27.55	1:21.32 27.97	<b>1:49.64</b> 28.32	1.56	q
3	6	TURAN Efe	TUR	0.67	25.97	53.89 27.92	1:22.41 28.52	<b>1:50.97</b> 28.56	2.89	q
4	2	BIANCHI Loris	SMR	0.73	27.28	56.80 29.52	1:26.22 29.42	<b>1:54.94</b> 28.72	6.86	
5	7	MANOLI Christos	CYP	0.68	27.33	56.75 29.42	1:27.17 30.42	<b>1:58.20</b> 31.03	10.12	

NOT CLASSIFIED

3	MOLLA YANES Mario	ESP						<b>DNS</b>		
---	-------------------	-----	--	--	--	--	--	------------	--	--

Issued: 05/07/2022 at 10:40



## Results

### Event 33

05/07/2022 - 10:40

WR	1:42.00	BIEDERMANN PAUL	GER	2009							
CR	1:46.44	OUSSAMA MELLOULI	TUN	2009							
JR	1:44.62	HWANG SUN WOO	KOR	2021							
1	3	5	<b>MEGLI Filippo</b>	ITA	0.65	25.12	52.02 26.90	1:19.81 27.79	<b>1:48.08</b>	28.27	q
2	1	5	<b>DOMINGUEZ CALONGE Luis</b>	ESP	0.71	25.49	52.96 27.47	1:21.29 28.33	<b>1:49.10</b>	27.81	1.02 q
3	3	4	<b>UNLU Baturalp</b>	TUR	0.68	25.80	53.35 27.55	1:21.32 27.97	<b>1:49.64</b>	28.32	1.56 q
4	2	4	<b>PROIETTI COLONNA Alessio</b>	ITA	0.64	25.78	53.31 27.53	1:21.40 28.09	<b>1:49.94</b>	28.54	1.86 q
5	2	3	<b>BOSKAN Saso</b>	SLO	0.62	26.29	54.55 28.26	1:22.88 28.33	<b>1:50.08</b>	27.20	2.00 q
6	1	6	<b>BOUCHAUT Joris Levy</b>	FRA	0.73	26.27	53.73 27.46	1:21.77 28.04	<b>1:50.12</b>	28.35	2.04 q
7	3	6	<b>TURAN Efe</b>	TUR	0.67	25.97	53.89 27.92	1:22.41 28.52	<b>1:50.97</b>	28.56	2.89 q
8	2	5	<b>MARKOS Dimitrios</b>	GRE	0.71	26.03	54.07 28.04	1:22.48 28.41	<b>1:51.10</b>	28.62	3.02 q
9	2	2	<b>ALMEIDA LOPES Gabriel</b>	POR	0.61	26.90	55.20 28.30	1:23.58 28.38	<b>1:52.37</b>	28.79	4.29 R1
10	2	6	<b>HUG-DREYFUS Tom Paul</b>	FRA	0.65	26.80	55.75 28.95	1:24.65 28.90	<b>1:53.40</b>	28.75	5.32 R2
11	1	4	<b>LAGILI Mohamed Mehdi</b>	TUN	0.78	25.96	53.80 27.84	1:22.99 29.19	<b>1:53.46</b>	30.47	5.38
12	1	3	<b>DJABALLAH Mohamed Anisse</b>	ALG	0.73	26.55	55.16 28.61	1:23.79 28.63	<b>1:53.69</b>	29.90	5.61
13	1	2	<b>ACHOUR TALET Sofiane</b>	ALG	0.63	27.13	55.55 28.42	1:24.42 28.87	<b>1:53.94</b>	29.52	5.86
14	3	2	<b>BIANCHI Loris</b>	SMR	0.73	27.28	56.80 29.52	1:26.22 29.42	<b>1:54.94</b>	28.72	6.86
15	3	7	<b>MANOLI Christos</b>	CYP	0.68	27.33	56.75 29.42	1:27.17 30.42	<b>1:58.20</b>	31.03	10.12
16	2	7	<b>ASHOUR Abdulhay</b>	LBA	0.74	28.63	59.80 31.17	1:31.89 32.09	<b>2:03.53</b>	31.64	15.45
NOT CLASSIFIED											
	3	3	<b>MOLLA YANES Mario</b>	ESP					<b>DNS</b>		

Issued: 05/07/2022 at 10:40



# Swimming



## Results

RANK	LANE	SURNAME & NAME			NOC	BORN			R.T.	TIME	GAP	FINA PTS
	50m	100m	150m	200m	250m	300m	350m					

Event 17  
03/07/2022 - 18:00

### 400m Freestyle Men Final

WR	3:40.07	BIEDERMANN PAUL		GER	2009
CR	3:42.71	OUSSAMA MELLOULI		TUN	2009
WJ	3:44.60	HORTON MACK		AUS	2014

### Final

1	7	<b>MARKOS Dimitrios</b>	GRE	0.71	<b>3:48.72</b>	
		26.76(3) 55.49(1) 1:24.67(2) 1:53.81(1) 2:23.29(2) 2:51.96(1) 3:20.21(1)				
		28.73 29.18 29.14 29.48 28.67 28.25				28.51
2	4	<b>BOUCHAUT Joris Levy</b>	FRA	0.72	<b>3:49.45</b>	0.73
		26.99(4) 55.99(4) 1:25.33(4) 1:54.34(3) 2:23.53(3) 2:53.05(3) 3:21.76(2)				
		29.00 29.34 29.01 29.19 29.52 28.71				27.69
3	6	<b>DE TULLIO Luca</b>	ITA	0.64	<b>3:50.11</b>	1.39
		26.72(2) 55.49(1) 1:24.57(1) 1:53.93(2) 2:23.14(1) 2:52.87(2) 3:22.17(3)				
		28.77 29.08 29.36 29.21 29.73 29.30				27.94
4	5	<b>FILIZ Batuhan</b>	TUR	0.69	<b>3:50.26</b>	1.54
		27.30(8) 56.00(5) 1:25.15(3) 1:54.50(4) 2:23.77(4) 2:53.09(4) 3:22.25(4)				
		28.70 29.15 29.35 29.27 29.32 29.16				28.01
5	2	<b>QUIJADA ROLDAN Carlos</b>	ESP	0.67	<b>3:52.23</b>	3.51
		27.03(5) 56.41(6) 1:25.71(7) 1:55.34(6) 2:24.68(5) 2:54.48(5) 3:23.68(5)				
		29.38 29.30 29.63 29.34 29.80 29.20				28.55
6	3	<b>BOSKAN Saso</b>	SLO	0.64	<b>3:52.24</b>	3.52
		27.29(7) 56.43(7) 1:26.01(8) 1:55.47(7) 2:25.07(6) 2:55.07(6) 3:24.84(6)				
		29.14 29.58 29.46 29.60 30.00 29.77				27.40
7	8	<b>DOMINGUEZ CALONGE Luis</b>	ESP	0.71	<b>3:54.48</b>	5.76
		26.49(1) 55.67(3) 1:25.45(5) 1:55.17(5) 2:25.10(7) 2:55.48(7) 3:26.02(7)				
		29.18 29.78 29.72 29.93 30.38 30.54				28.46
8	1	<b>PROIETTI COLONNA Alessio</b>	ITA	0.66	<b>3:56.12</b>	7.40
		27.06(6) 56.50(8) 1:25.51(6) 1:55.55(8) 2:25.14(8) 2:55.61(8) 3:26.16(8)				
		29.44 29.01 30.04 29.59 30.47 30.55				29.96

Issued: 03/07/2022 at 18:07



# Swimming



## Results

RANK	LANE	SURNAME & NAME			NOC	BORN			R.T.	TIME	GAP	FINA PTS
		50m	100m	150m		200m	250m	300m				

Event 17  
03/07/2022 - 10:00

### 400m Freestyle Men Preliminary

WR	3:40.07	BIEDERMANN PAUL	GER	2009
CR	3:42.71	OUSSAMA MELLOULI	TUN	2009
WJ	3:44.60	HORTON MACK	AUS	2014

#### Heat 1 of 3

1	5	<b>DRUENNE Theo</b>	MON	0.69	<b>4:08.36</b>	
		28.41(1) 59.18(1) 30.77	1:30.82(1) 31.64	2:02.38(1) 31.56	2:34.30(1) 31.92	3:05.84(1) 31.54
						3:38.01(1) 32.17
						30.35
2	3	<b>ASHOUR Abdulhay</b>	LBA	0.75	<b>4:29.51</b>	21.15
		30.25(2) 1:02.78(2) 32.53	1:36.55(2) 33.77	2:10.97(2) 34.42	2:46.00(2) 35.03	3:21.49(2) 35.49
						3:56.81(2) 35.32
						32.70
NOT CLASSIFIED						
	4	<b>JOUADI Ahmed</b>	TUN		<b>DNS</b>	

Issued: 03/07/2022 at 10:06

#### Heat 2 of 3

1	4	<b>DE TULLIO Luca</b>	ITA	0.66	<b>3:53.75</b>	q
		27.09(1) 56.29(1) 29.20	1:25.66(1) 29.37	1:55.48(1) 29.82	2:25.63(1) 30.15	2:55.58(1) 29.95
						3:25.56(1) 29.98
						28.19
2	6	<b>QUIJADA ROLDAN Carlos</b>	ESP	0.65	<b>3:54.25</b>	0.50 q
		27.67(5) 56.91(3) 29.24	1:26.30(3) 29.39	1:56.21(3) 29.91	2:25.90(3) 29.69	2:55.82(3) 29.92
						3:25.59(2) 29.77
						28.66
3	5	<b>MARKOS Dimitrios</b>	GRE	0.73	<b>3:54.33</b>	0.58 q
		27.31(3) 56.49(2) 29.18	1:25.96(2) 29.47	1:55.55(2) 29.59	2:25.81(2) 30.26	2:55.75(2) 29.94
						3:25.64(3) 29.89
						28.69
4	2	<b>DOMINGUEZ CALONGE Luis</b>	ESP	0.72	<b>3:57.76</b>	4.01 q
		27.17(2) 57.02(5) 29.85	1:26.89(5) 29.87	1:57.15(5) 30.26	2:27.46(4) 30.31	2:58.67(5) 31.21
						3:28.93(4) 30.26
						28.83
5	3	<b>TURAN Efe</b>	TUR	0.72	<b>3:59.46</b>	5.71 R1
		27.34(4) 56.98(4) 29.64	1:26.50(4) 29.52	1:56.77(4) 30.27	2:27.48(5) 30.71	2:58.40(4) 30.92
						3:29.48(5) 31.08
						29.98
6	7	<b>BIANCHI Loris</b>	SMR	0.72	<b>4:00.64</b>	6.89 R2
		27.78(6) 57.23(6) 29.45	1:27.24(6) 30.01	1:57.78(6) 30.54	2:28.77(6) 30.99	2:59.90(6) 31.13
						3:30.81(6) 30.91
						29.83
7	1	<b>MANOLI Christos</b>	CYP	0.67	<b>4:09.52</b>	15.77
		28.44(7) 59.12(7) 30.68	1:29.75(7) 30.63	2:01.60(7) 31.85	2:33.42(7) 31.82	3:05.88(7) 32.46
						3:37.89(7) 32.01
						31.63
NOT CLASSIFIED						
	8	<b>LAGILI Mohamed Mehdi</b>	TUN		<b>DNS</b>	

Issued: 03/07/2022 at 10:13

#### Heat 3 of 3

1	5	<b>BOUCHAUT Joris Levy</b>	FRA	0.72	<b>3:52.40</b>	q
		26.40(1) 55.16(1) 28.76	1:24.40(1) 29.24	1:54.02(1) 29.62	2:24.19(1) 30.17	2:54.22(1) 30.03
						3:24.21(1) 29.99
						28.19
2	3	<b>FILIZ Batuhan</b>	TUR	0.69	<b>3:52.52</b>	0.12 q
		27.42(5) 56.39(5) 28.97	1:25.70(3) 29.31	1:55.33(2) 29.63	2:25.04(2) 29.71	2:54.76(2) 29.72
						3:24.40(2) 29.64
						28.12
3	7	<b>BOSKAN Saso</b>	SLO	0.63	<b>3:53.40</b>	1.00 q
		26.90(2) 55.96(2) 29.06	1:25.66(2) 29.70	1:55.61(3) 29.95	2:25.71(3) 30.10	2:55.64(3) 29.93
						3:25.20(3) 29.56
						28.20
4	2	<b>PROIETTI COLONNA Alessio</b>	ITA	0.64	<b>3:56.83</b>	4.43 q
		27.31(4) 56.17(3) 28.86	1:25.85(4) 29.68	1:56.04(4) 30.19	2:25.90(4) 29.86	2:56.37(4) 30.47
						3:26.77(4) 30.40
						30.06
5	6	<b>DJABALLAH Mohamed Anisse</b>	ALG	0.74	<b>4:03.41</b>	11.01
		27.08(3) 56.36(4) 29.28	1:26.39(5) 30.03	1:56.92(5) 30.53	2:28.06(5) 31.14	2:59.96(5) 31.90
						3:32.02(5) 32.06
						31.39

# Swimming



## Results



RANK	LANE	SURNAME & NAME	NOC	BORN	R.T.	TIME	GAP	FINA PTS
6	1	<b>KHENDRICHE Lounis</b>	ALG		0.78	<b>4:10.15</b>	17.75	
		27.57(6) 57.57(6) 1:27.56(6)	1:59.04(6)	2:30.60(6)	3:03.68(6)	3:36.94(6)		
		30.00 29.99 31.48	31.56	33.08	33.26	33.21		
NOT CLASSIFIED								
	8	<b>STAMOU Konstantinos</b>	GRE			<b>DNS-M</b>		

Issued: 03/07/2022 at 10:20



# Swimming



## Results

RANK	HEAT	LANE	SURNAME & NAME			NOC	BORN			R.T.	TIME	GAP	FINA	PTS
			50m	100m	150m	200m	250m	300m	350m					

Event 17  
03/07/2022 - 10:00

### 400m Freestyle Men Preliminary

WR	3:40.07	BIEDERMANN PAUL	GER	2009
CR	3:42.71	OUSSAMA MELLOULI	TUN	2009
WJ	3:44.60	HORTON MACK	AUS	2014

1	3	5	<b>BOUCHAUT Joris Levy</b>	FRA					0.72	<b>3:52.40</b>			q
			26.40	55.16	1:24.40	1:54.02	2:24.19	2:54.22	3:24.21				
				28.76	29.24	29.62	30.17	30.03	29.99		28.19		
2	3	3	<b>FILIZ Batuhan</b>	TUR					0.69	<b>3:52.52</b>	0.12		q
			27.42	56.39	1:25.70	1:55.33	2:25.04	2:54.76	3:24.40				
				28.97	29.31	29.63	29.71	29.72	29.64		28.12		
3	3	7	<b>BOSKAN Saso</b>	SLO					0.63	<b>3:53.40</b>	1.00		q
			26.90	55.96	1:25.66	1:55.61	2:25.71	2:55.64	3:25.20				
				29.06	29.70	29.95	30.10	29.93	29.56		28.20		
4	2	4	<b>DE TULLIO Luca</b>	ITA					0.66	<b>3:53.75</b>	1.35		q
			27.09	56.29	1:25.66	1:55.48	2:25.63	2:55.58	3:25.56				
				29.20	29.37	29.82	30.15	29.95	29.98		28.19		
5	2	6	<b>QUIJADA ROLDAN Carlos</b>	ESP					0.65	<b>3:54.25</b>	1.85		q
			27.67	56.91	1:26.30	1:56.21	2:25.90	2:55.82	3:25.59				
				29.24	29.39	29.91	29.69	29.92	29.77		28.66		
6	2	5	<b>MARKOS Dimitrios</b>	GRE					0.73	<b>3:54.33</b>	1.93		q
			27.31	56.49	1:25.96	1:55.55	2:25.81	2:55.75	3:25.64				
				29.18	29.47	29.59	30.26	29.94	29.89		28.69		
7	3	2	<b>PROIETTI COLONNA Alessio</b>	ITA					0.64	<b>3:56.83</b>	4.43		q
			27.31	56.17	1:25.85	1:56.04	2:25.90	2:56.37	3:26.77				
				28.86	29.68	30.19	29.86	30.47	30.40		30.06		
8	2	2	<b>DOMINGUEZ CALONGE Luis</b>	ESP					0.72	<b>3:57.76</b>	5.36		q
			27.17	57.02	1:26.89	1:57.15	2:27.46	2:58.67	3:28.93				
				29.85	29.87	30.26	30.31	31.21	30.26		28.83		
9	2	3	<b>TURAN Efe</b>	TUR					0.72	<b>3:59.46</b>	7.06		R1
			27.34	56.98	1:26.50	1:56.77	2:27.48	2:58.40	3:29.48				
				29.64	29.52	30.27	30.71	30.92	31.08		29.98		
10	2	7	<b>BIANCHI Loris</b>	SMR					0.72	<b>4:00.64</b>	8.24		R2
			27.78	57.23	1:27.24	1:57.78	2:28.77	2:59.90	3:30.81				
				29.45	30.01	30.54	30.99	31.13	30.91		29.83		
11	3	6	<b>DJABALLAH Mohamed Anisse</b>	ALG					0.74	<b>4:03.41</b>	11.01		
			27.08	56.36	1:26.39	1:56.92	2:28.06	2:59.96	3:32.02				
				29.28	30.03	30.53	31.14	31.90	32.06		31.39		
12	1	5	<b>DRUENNE Theo</b>	MON					0.69	<b>4:08.36</b>	15.96		
			28.41	59.18	1:30.82	2:02.38	2:34.30	3:05.84	3:38.01				
				30.77	31.64	31.56	31.92	31.54	32.17		30.35		
13	2	1	<b>MANOLI Christos</b>	CYP					0.67	<b>4:09.52</b>	17.12		
			28.44	59.12	1:29.75	2:01.60	2:33.42	3:05.88	3:37.89				
				30.68	30.63	31.85	31.82	32.46	32.01		31.63		
14	3	1	<b>KHENDRICHE Lounis</b>	ALG					0.78	<b>4:10.15</b>	17.75		
			27.57	57.57	1:27.56	1:59.04	2:30.60	3:03.68	3:36.94				
				30.00	29.99	31.48	31.56	33.08	33.26		33.21		
15	1	3	<b>ASHOUR Abdulhay</b>	LBA					0.75	<b>4:29.51</b>	37.11		
			30.25	1:02.78	1:36.55	2:10.97	2:46.00	3:21.49	3:56.81				
				32.53	33.77	34.42	35.03	35.49	35.32		32.70		

NOT CLASSIFIED

1	4		<b>JOUADI Ahmed</b>	TUN									DNS
2	8		<b>LAGILI Mohamed Mehdi</b>	TUN									DNS
3	8		<b>STAMOU Konstantinos</b>	GRE									DNS-M

Issued: 03/07/2022 at 10:20



RANK	LANE	SURNAME & NAME	NOC	BORN	R.T.	TIME	GAP	FINA	PTS		
8	7	<b>JOUADI Ahmed</b>	TUN			0.75	<b>15:41.75</b>		31.64		
		28.15(5)		58.44(5)	1:29.37(5)	2:00.59(8)	2:31.16(8)	3:01.64(6)	3:32.17(5)	4:03.18(5)	
				30.29	30.93	31.22	30.57	30.48	30.53	31.01	
		4:33.79(5)		5:05.01(6)	5:35.84(6)	6:06.80(7)	6:38.14(7)	7:09.31(8)	7:40.84(8)	8:11.92(8)	
				30.61	31.22	30.83	30.96	31.34	31.17	31.53	
		8:44.23(8)		9:15.58(8)	9:47.51(8)	10:19.39(8)	10:51.91(8)	11:24.04(8)	11:56.63(8)	12:28.87(8)	
				32.31	31.35	31.93	31.88	32.52	32.13	32.24	
		13:01.30(8)		13:33.79(8)	14:06.26(8)	14:38.80(8)	15:11.12(8)				
				32.43	32.49	32.47	32.54	32.32	30.63		

Issued: 03/07/2022 at 19:32



# Swimming



## Results

RANK	LANE	SURNAME & NAME			NOC	BORN		R.T.	TIME	GAP	FINA
	50m	100m	150m	200m	250m	300m	350m	400m			PTS
	450m	500m	550m	600m	650m	700m	750m	800m			
	850m	900m	950m	1000m	1050m	1100m	1150m	1200m			
	1250m	1300m	1350m	1400m	1450m						

Event 16  
02/07/2022 - 11:39

## 1500m Freestyle Men Preliminary

WR	14:00.31	SUN YANG	CHN	2012
CR	14:38.01	OUSSAMA MELLOULI	TUN	2009

### Heat 1 of 2

1	6	<b>FILIZ Batuhan</b>	TUR	0.69	<b>15:18.99</b>		q				
	28.55(4)	59.02(3)	1:29.90(2)	2:00.46(2)	2:30.94(2)	3:01.91(2)	3:32.69(2)	4:03.33(2)			
		30.47	30.88	30.56	30.48	30.97	30.78	30.64			
	4:34.50(2)	5:05.35(2)	5:36.45(2)	6:07.24(2)	6:38.10(2)	7:09.06(2)	7:39.75(2)	8:10.66(2)			
	31.17	30.85	31.10	30.79	30.86	30.96	30.69	30.91			
	8:41.43(2)	9:12.19(2)	9:42.91(2)	10:13.59(2)	10:44.26(2)	11:15.06(2)	11:45.66(2)	12:16.01(2)			
	30.77	30.76	30.72	30.68	30.67	30.80	30.60	30.35			
	12:46.60(2)	13:17.28(2)	13:47.89(1)	14:18.31(1)	14:48.87(1)						
	30.59	30.68	30.61	30.42	30.56	30.12					
2	3	<b>ESCRITS MANOSA Albert</b>	ESP	0.73	<b>15:20.51</b>		1.52	q			
	27.53(1)	57.61(1)	1:28.12(1)	1:58.73(1)	2:29.45(1)	3:00.35(1)	3:31.17(1)	4:02.17(1)			
		30.08	30.51	30.61	30.72	30.90	30.82	31.00			
	4:32.94(1)	5:03.88(1)	5:34.36(1)	6:05.08(1)	6:35.64(1)	7:06.31(1)	7:36.96(1)	8:07.74(1)			
	30.77	30.94	30.48	30.72	30.56	30.67	30.65	30.78			
	8:38.48(1)	9:09.28(1)	9:40.25(1)	10:11.21(1)	10:41.90(1)	11:12.70(1)	11:43.48(1)	12:14.72(1)			
	30.74	30.80	30.97	30.96	30.69	30.80	30.78	31.24			
	12:45.87(1)	13:17.22(1)	13:48.20(2)	14:19.54(2)	14:50.53(2)						
	31.15	31.35	30.98	31.34	30.99	29.98					
3	4	<b>KILAVUZ Mert</b>	TUR	0.79	<b>15:30.50</b>		11.51	q			
	28.41(3)	58.98(2)	1:30.17(3)	2:01.22(3)	2:32.41(3)	3:03.66(3)	3:34.86(3)	4:05.91(3)			
		30.57	31.19	31.05	31.19	31.25	31.20	31.05			
	4:37.18(3)	5:08.24(3)	5:39.43(3)	6:10.44(3)	6:41.75(3)	7:12.56(3)	7:43.21(3)	8:13.95(3)			
	31.27	31.06	31.19	31.01	31.31	30.81	30.65	30.74			
	8:44.86(3)	9:15.54(3)	9:46.42(3)	10:17.26(3)	10:48.16(3)	11:19.08(3)	11:50.24(3)	12:21.46(3)			
	30.91	30.68	30.88	30.84	30.90	30.92	31.16	31.22			
	12:53.03(3)	13:24.75(3)	13:56.27(3)	14:28.03(3)	14:59.67(3)						
	31.57	31.72	31.52	31.76	31.64	30.83					
4	5	<b>DALU Fabio</b>	ITA	0.72	<b>15:35.90</b>		16.91	q			
	28.35(2)	59.35(4)	1:30.60(4)	2:01.64(4)	2:32.71(4)	3:04.04(4)	3:35.16(4)	4:06.30(4)			
		31.00	31.25	31.04	31.07	31.33	31.12	31.14			
	4:37.47(4)	5:08.62(4)	5:39.75(4)	6:10.87(4)	6:41.86(4)	7:13.02(4)	7:44.08(4)	8:15.19(4)			
	31.17	31.15	31.13	31.12	30.99	31.16	31.06	31.11			
	8:46.47(4)	9:18.08(4)	9:49.69(4)	10:21.35(4)	10:52.98(4)	11:24.47(4)	11:56.20(4)	12:27.96(4)			
	31.28	31.61	31.61	31.66	31.63	31.49	31.73	31.76			
	12:59.84(4)	13:31.33(4)	14:03.05(4)	14:34.56(4)	15:06.18(4)						
	31.88	31.49	31.72	31.51	31.62	29.72					
5	2	<b>DRUENNE Theo</b>	MON	0.70	<b>16:33.07</b>		1:14.08				
	28.82(6)	1:00.33(6)	1:32.38(6)	2:04.72(6)	2:36.89(6)	3:09.45(6)	3:42.02(6)	4:14.36(6)			
		31.51	32.05	32.34	32.17	32.56	32.57	32.34			
	4:46.96(6)	5:19.89(6)	5:52.85(6)	6:25.98(6)	6:59.15(6)	7:32.31(6)	8:05.47(6)	8:38.91(5)			
	32.60	32.93	32.96	33.13	33.17	33.16	33.16	33.44			
	9:11.98(5)	9:45.60(5)	10:19.13(5)	10:53.21(5)	11:27.19(5)	12:01.43(5)	12:35.18(5)	13:09.26(5)			
	33.07	33.62	33.53	34.08	33.98	34.24	33.75	34.08			
	13:43.09(5)	14:17.28(5)	14:51.32(5)	15:25.53(5)	15:59.39(5)						
	33.83	34.19	34.04	34.21	33.86	33.68					
6	7	<b>MANOLI Christos</b>	CYP	0.65	<b>16:41.18</b>		1:22.19				
	28.77(5)	59.56(5)	1:30.63(5)	2:02.06(5)	2:33.86(5)	3:05.69(5)	3:37.93(5)	4:10.66(5)			
		30.79	31.07	31.43	31.80	31.83	32.24	32.73			
	4:43.68(5)	5:17.09(5)	5:50.54(5)	6:23.96(5)	6:57.45(5)	7:31.37(5)	8:05.17(5)	8:39.89(6)			
	33.02	33.41	33.45	33.42	33.49	33.92	33.80	34.72			
	9:14.23(6)	9:49.11(6)	10:24.22(6)	10:59.16(6)	11:33.85(6)	12:08.06(6)	12:41.69(6)	13:16.40(6)			
	34.34	34.88	35.11	34.94	34.69	34.21	33.63	34.71			
	13:50.69(6)	14:25.28(6)	14:59.87(6)	15:34.22(6)	16:08.70(6)						
	34.29	34.59	34.59	34.35	34.48	32.48					

Issued: 02/07/2022 at 11:43

### Heat 2 of 2

RANK	LANE	SURNAME & NAME		NOC	BORN		R.T.	TIME	GAP	FINA	PTS
1	5	<b>BOUCHAUT Joris Levy</b>		FRA			0.72	<b>15:29.48</b>			q
		28.55(4)	59.16(4)	1:30.02(3)	2:00.92(3)	2:31.59(3)	3:02.48(3)	3:33.50(3)	4:04.18(3)		
			30.61	30.86	30.90	30.67	30.89	31.02	30.68		
		4:34.91(3)	5:05.88(3)	5:36.56(3)	6:07.39(2)	6:38.28(2)	7:09.22(2)	7:40.06(2)	8:11.28(2)		
		30.73	30.97	30.68	30.83	30.89	30.94	30.84	31.22		
		8:42.52(2)	9:13.89(2)	9:45.12(2)	10:16.51(2)	10:47.82(2)	11:19.35(2)	11:50.88(2)	12:22.63(2)		
		31.24	31.37	31.23	31.39	31.31	31.53	31.53	31.75		
		12:53.46(2)	13:23.96(2)	13:55.36(2)	14:27.70(2)	14:58.80(2)					
		30.83	30.50	31.40	32.34	31.10	30.68				
2	4	<b>DE TULLIO Luca</b>		ITA			0.71	<b>15:29.61</b>	0.13		q
		27.93(1)	57.97(1)	1:28.66(1)	1:59.31(1)	2:30.21(1)	3:00.74(1)	3:31.64(1)	4:02.71(1)		
			30.04	30.69	30.65	30.90	30.53	30.90	31.07		
		4:33.42(1)	5:04.20(1)	5:34.68(1)	6:05.55(1)	6:36.50(1)	7:07.57(1)	7:38.59(1)	8:09.66(1)		
		30.71	30.78	30.48	30.87	30.95	31.07	31.02	31.07		
		8:40.82(1)	9:11.99(1)	9:43.16(1)	10:14.35(1)	10:45.51(1)	11:16.96(1)	11:48.28(1)	12:19.82(1)		
		31.16	31.17	31.17	31.19	31.16	31.45	31.32	31.54		
		12:51.35(1)	13:23.04(1)	13:54.97(1)	14:27.17(1)	14:58.33(1)					
		31.53	31.69	31.93	32.20	31.16	31.28				
3	3	<b>JOUADI Ahmed</b>		TUN			0.74	<b>15:35.04</b>	5.56		q
		27.95(2)	58.37(2)	1:29.17(2)	1:59.68(2)	2:30.87(2)	3:01.57(2)	3:32.55(2)	4:03.38(2)		
			30.42	30.80	30.51	31.19	30.70	30.98	30.83		
		4:34.43(2)	5:05.10(2)	5:36.12(2)	6:07.42(3)	6:38.81(3)	7:09.97(3)	7:41.26(4)	8:12.62(4)		
		31.05	30.67	31.02	31.30	31.39	31.16	31.29	31.36		
		8:44.06(4)	9:15.80(4)	9:47.49(4)	10:19.39(4)	10:50.95(4)	11:22.69(4)	11:54.91(4)	12:27.09(4)		
		31.44	31.74	31.69	31.90	31.56	31.74	32.22	32.18		
		12:58.81(4)	13:31.26(4)	14:03.20(4)	14:34.83(3)	15:06.42(4)					
		31.72	32.45	31.94	31.63	31.59	28.62				
4	6	<b>MARKOS Dimitrios</b>		GRE			0.72	<b>15:35.08</b>	5.60		q
		28.91(6)	59.84(5)	1:30.60(5)	2:01.56(5)	2:32.24(4)	3:03.26(4)	3:34.29(4)	4:05.16(4)		
			30.93	30.76	30.96	30.68	31.02	31.03	30.87		
		4:35.89(4)	5:06.74(4)	5:37.42(4)	6:08.22(4)	6:39.26(4)	7:10.06(4)	7:40.82(3)	8:11.76(3)		
		30.73	30.85	30.68	30.80	31.04	30.80	30.76	30.94		
		8:42.69(3)	9:14.24(3)	9:45.96(3)	10:18.81(3)	10:50.79(3)	11:22.51(3)	11:54.38(3)	12:26.52(3)		
		30.93	31.55	31.72	32.85	31.98	31.72	31.87	32.14		
		12:58.41(3)	13:30.79(3)	14:02.73(3)	14:34.87(4)	15:05.63(3)					
		31.89	32.38	31.94	32.14	30.76	29.45				
5	7	<b>BIANCHI Loris</b>		SMR			0.69	<b>16:03.32</b>	33.84		R1
		28.82(5)	59.90(6)	1:31.64(6)	2:03.05(6)	2:34.95(6)	3:06.30(6)	3:38.08(6)	4:09.86(6)		
			31.08	31.74	31.41	31.90	31.35	31.78	31.78		
		4:42.03(6)	5:13.98(6)	5:45.92(5)	6:17.82(5)	6:49.90(5)	7:21.91(5)	7:54.05(5)	8:25.95(5)		
		32.17	31.95	31.94	31.90	32.08	32.01	32.14	31.90		
		8:58.52(5)	9:31.03(5)	10:03.96(5)	10:37.05(5)	11:09.69(5)	11:42.20(5)	12:14.95(5)	12:48.02(5)		
		32.57	32.51	32.93	33.09	32.64	32.51	32.75	33.07		
		13:21.18(5)	13:54.46(5)	14:27.69(5)	15:00.05(5)	15:32.22(5)					
		33.16	33.28	33.23	32.36	32.17	31.10				
6	2	<b>DJABALLAH Mohamed Anisse</b>		ALG			0.79	<b>16:11.93</b>	42.45		R2
		28.16(3)	59.08(3)	1:30.15(4)	2:01.46(4)	2:32.80(5)	3:04.64(5)	3:36.54(5)	4:08.78(5)		
			30.92	31.07	31.31	31.34	31.84	31.90	32.24		
		4:41.35(5)	5:13.77(5)	5:46.15(6)	6:18.54(6)	6:51.11(6)	7:23.54(6)	7:56.12(6)	8:29.15(6)		
		32.57	32.42	32.38	32.39	32.57	32.43	32.58	33.03		
		9:02.01(6)	9:35.44(6)	10:08.66(6)	10:41.90(6)	11:14.24(6)	11:47.07(6)	12:20.17(6)	12:53.38(6)		
		32.86	33.43	33.22	33.24	32.34	32.83	33.10	33.21		
		13:26.49(6)	13:59.93(6)	14:32.83(6)	15:06.29(6)	15:39.81(6)					
		33.11	33.44	32.90	33.46	33.52	32.12				

Issued: 02/07/2022 at 12:03

# Swimming



## Results

RANK	HEAT	LANE	SURNAME & NAME	NOC	BORN	R.T.	TIME	GAP	FINA
		50m	100m	150m	200m	250m	300m	350m	400m
		450m	500m	550m	600m	650m	700m	750m	800m
		850m	900m	950m	1000m	1050m	1100m	1150m	1200m
		1250m	1300m	1350m	1400m	1450m			

### Event 16

02/07/2022 - 11:39

## 1500m Freestyle Men Preliminary

WR	14:00.31	SUN YANG	CHN	2012
CR	14:38.01	OUSSAMA MELLOULI	TUN	2009

RANK	HEAT	LANE	SURNAME & NAME	NOC	BORN	R.T.	TIME	GAP	FINA
1	1	6	<b>FILIZ Batuhan</b>	TUR		0.69	<b>15:18.99</b>		q
		28.55	59.02	1:29.90	2:00.46	2:30.94	3:01.91	3:32.69	4:03.33
			30.47	30.88	30.56	30.48	30.97	30.78	30.64
		4:34.50	5:05.35	5:36.45	6:07.24	6:38.10	7:09.06	7:39.75	8:10.66
			31.17	31.10	30.79	30.86	30.96	30.69	30.91
		8:41.43	9:12.19	9:42.91	10:13.59	10:44.26	11:15.06	11:45.66	12:16.01
			30.77	30.72	30.68	30.67	30.80	30.60	30.35
		12:46.60	13:17.28	13:47.89	14:18.31	14:48.87			
			30.59	30.61	30.42	30.56	30.12		
2	1	3	<b>ESCRITS MANOSA Albert</b>	ESP		0.73	<b>15:20.51</b>	1.52	q
		27.53	57.61	1:28.12	1:58.73	2:29.45	3:00.35	3:31.17	4:02.17
			30.08	30.51	30.61	30.72	30.90	30.82	31.00
		4:32.94	5:03.88	5:34.36	6:05.08	6:35.64	7:06.31	7:36.96	8:07.74
			30.77	30.94	30.48	30.72	30.66	30.67	30.78
		8:38.48	9:09.28	9:40.25	10:11.21	10:41.90	11:12.70	11:43.48	12:14.72
			30.74	30.97	30.96	30.69	30.80	30.78	31.24
		12:45.87	13:17.22	13:48.20	14:19.54	14:50.53			
			31.15	31.35	31.34	30.99	29.98		31.24
3	2	5	<b>BOUCHAUT Joris Levy</b>	FRA		0.72	<b>15:29.48</b>	10.49	q
		28.55	59.16	1:30.02	2:00.92	2:31.59	3:02.48	3:33.50	4:04.18
			30.61	30.86	30.90	30.67	30.89	31.02	30.68
		4:34.91	5:05.88	5:36.56	6:07.39	6:38.28	7:09.22	7:40.06	8:11.28
			30.73	30.97	30.83	30.89	30.94	30.84	31.22
		8:42.52	9:13.89	9:45.12	10:16.51	10:47.82	11:19.35	11:50.88	12:22.63
			31.24	31.37	31.39	31.31	31.53	31.53	31.75
		12:53.46	13:23.96	13:55.36	14:27.70	14:58.80			
			30.83	30.50	32.34	31.10	30.68		
4	2	4	<b>DE TULLIO Luca</b>	ITA		0.71	<b>15:29.61</b>	10.62	q
		27.93	57.97	1:28.66	1:59.31	2:30.21	3:00.74	3:31.64	4:02.71
			30.04	30.69	30.65	30.90	30.53	30.90	31.07
		4:33.42	5:04.20	5:34.68	6:05.55	6:36.50	7:07.57	7:38.59	8:09.66
			30.71	30.78	30.87	30.95	31.07	31.02	31.07
		8:40.82	9:11.99	9:43.16	10:14.35	10:45.51	11:16.96	11:48.28	12:19.82
			31.16	31.17	31.19	31.16	31.45	31.32	31.54
		12:51.35	13:23.04	13:54.97	14:27.17	14:58.33			
			31.53	31.69	32.20	31.16	31.28		
5	1	4	<b>KILAVUZ Mert</b>	TUR		0.79	<b>15:30.50</b>	11.51	q
		28.41	58.98	1:30.17	2:01.22	2:32.41	3:03.66	3:34.86	4:05.91
			30.57	31.19	31.05	31.19	31.25	31.20	31.05
		4:37.18	5:08.24	5:39.43	6:10.44	6:41.75	7:12.56	7:43.21	8:13.95
			31.27	31.19	31.01	31.31	30.81	30.65	30.74
		8:44.86	9:15.54	9:46.42	10:17.26	10:48.16	11:19.08	11:50.24	12:21.46
			30.91	30.68	30.84	30.90	30.92	31.16	31.22
		12:53.03	13:24.75	13:56.27	14:28.03	14:59.67			
			31.57	31.72	31.76	31.64	30.83		
6	2	3	<b>JOUADI Ahmed</b>	TUN		0.74	<b>15:35.04</b>	16.05	q
		27.95	58.37	1:29.17	1:59.68	2:30.87	3:01.57	3:32.55	4:03.38
			30.42	30.80	30.51	31.19	30.70	30.98	30.83
		4:34.43	5:05.10	5:36.12	6:07.42	6:38.81	7:09.97	7:41.26	8:12.62
			31.05	31.02	31.30	31.39	31.16	31.29	31.36
		8:44.06	9:15.80	9:47.49	10:19.39	10:50.95	11:22.69	11:54.91	12:27.09
			31.44	31.74	31.90	31.56	31.74	32.22	32.18
		12:58.81	13:31.26	14:03.20	14:34.83	15:06.42			
			31.72	32.45	31.94	31.63	28.62		
7	2	6	<b>MARKOS Dimitrios</b>	GRE		0.72	<b>15:35.08</b>	16.09	q
		28.91	59.84	1:30.60	2:01.56	2:32.24	3:03.26	3:34.29	4:05.16
			30.93	30.76	30.96	30.68	31.02	31.03	30.87
		4:35.89	5:06.74	5:37.42	6:08.22	6:39.26	7:10.06	7:40.82	8:11.76
			30.73	30.85	30.68	30.80	31.04	30.80	30.94
		8:42.69	9:14.24	9:45.96	10:18.81	10:50.79	11:22.51	11:54.38	12:26.52
			30.93	31.55	31.72	32.85	31.98	31.72	32.14
		12:58.41	13:30.79	14:02.73	14:34.87	15:05.63			
			31.89	32.38	31.94	32.14	30.76	29.45	

RANK	HEAT	LANE	SURNAME & NAME	NOC	BORN	R.T.	TIME	GAP	FINA	PTS	
8	1	5	<b>DALU Fabio</b>	ITA		0.72	<b>15:35.90</b>	16.91		q	
			28.35	59.35	1:30.60	2:01.64	2:32.71	3:04.04	3:35.16	4:06.30	
				31.00	31.25	31.04	31.07	31.33	31.12	31.14	
			4:37.47	5:08.62	5:39.75	6:10.87	6:41.86	7:13.02	7:44.08	8:15.19	
			31.17	31.15	31.13	31.12	30.99	31.16	31.06	31.11	
			8:46.47	9:18.08	9:49.69	10:21.35	10:52.98	11:24.47	11:56.20	12:27.96	
			31.28	31.61	31.61	31.66	31.63	31.49	31.73	31.76	
			12:59.84	13:31.33	14:03.05	14:34.56	15:06.18				
			31.88	31.49	31.72	31.51	31.62	29.72			
9	2	7	<b>BIANCHI Loris</b>	SMR		0.69	<b>16:03.32</b>	44.33		R1	
			28.82	59.90	1:31.64	2:03.05	2:34.95	3:06.30	3:38.08	4:09.86	
				31.08	31.74	31.41	31.90	31.35	31.78	31.78	
			4:42.03	5:13.98	5:45.92	6:17.82	6:49.90	7:21.91	7:54.05	8:25.95	
			32.17	31.95	31.94	31.90	32.08	32.01	32.14	31.90	
			8:58.52	9:31.03	10:03.96	10:37.05	11:09.69	11:42.20	12:14.95	12:48.02	
			32.57	32.51	32.93	33.09	32.64	32.51	32.75	33.07	
			13:21.18	13:54.46	14:27.69	15:00.05	15:32.22				
			33.16	33.28	33.23	32.36	32.17	31.10			
10	2	2	<b>DJABALLAH Mohamed Anisse</b>	ALG		0.79	<b>16:11.93</b>	52.94		R2	
			28.16	59.08	1:30.15	2:01.46	2:32.80	3:04.64	3:36.54	4:08.78	
				30.92	31.07	31.31	31.34	31.84	31.90	32.24	
			4:41.35	5:13.77	5:46.15	6:18.54	6:51.11	7:23.54	7:56.12	8:29.15	
			32.57	32.42	32.38	32.39	32.57	32.43	32.58	33.03	
			9:02.01	9:35.44	10:08.66	10:41.90	11:14.24	11:47.07	12:20.17	12:53.38	
			32.86	33.43	33.22	33.24	32.34	32.83	33.10	33.21	
			13:26.49	13:59.93	14:32.83	15:06.29	15:39.81				
			33.11	33.44	32.90	33.46	33.52	32.12			
11	1	2	<b>DRUENNE Theo</b>	MON		0.70	<b>16:33.07</b>	1:14.08			
			28.82	1:00.33	1:32.38	2:04.72	2:36.89	3:09.45	3:42.02	4:14.36	
				31.51	32.05	32.34	32.17	32.56	32.57	32.34	
			4:46.96	5:19.89	5:52.85	6:25.98	6:59.15	7:32.31	8:05.47	8:38.91	
			32.60	32.93	32.96	33.13	33.17	33.16	33.16	33.44	
			9:11.98	9:45.60	10:19.13	10:53.21	11:27.19	12:01.43	12:35.18	13:09.26	
			33.07	33.62	33.53	34.08	33.98	34.24	33.75	34.08	
			13:43.09	14:17.28	14:51.32	15:25.53	15:59.39				
			33.83	34.19	34.04	34.21	33.86	33.68			
12	1	7	<b>MANOLI Christos</b>	CYP		0.65	<b>16:41.18</b>	1:22.19			
			28.77	59.56	1:30.63	2:02.06	2:33.86	3:05.69	3:37.93	4:10.66	
				30.79	31.07	31.43	31.80	31.83	32.24	32.73	
			4:43.68	5:17.09	5:50.54	6:23.96	6:57.45	7:31.37	8:05.17	8:39.89	
			33.02	33.41	33.45	33.42	33.49	33.92	33.80	34.72	
			9:14.23	9:49.11	10:24.22	10:59.16	11:33.85	12:08.06	12:41.69	13:16.40	
			34.34	34.88	35.11	34.94	34.69	34.21	33.63	34.71	
			13:50.69	14:25.28	14:59.87	15:34.22	16:08.70				
			34.29	34.59	34.59	34.35	34.48	32.48			

Issued: 02/07/2022 at 12:03

# Swimming



## Results



RANK LANE SURNAME & NAME NOC BORN R.T. TIME GAP FINA PTS

### Event 19

03/07/2022 - 18:19

### 50m Backstroke Men Final

WR	23.71	ARMSTRONG HUNTER	USA	2022
CR	24.73	ASHWIN WILDEBOER FABER	ESP	2009
WJ	21.75	ANDREW MICHAEL C	USA	2017

### Final

1	4	STEFANTH Simone	ITA	0.69	<b>25.00</b>	
2	6	SEGURA GUTIERREZ Juan	ESP	0.55	<b>25.09</b>	0.09
3	7	MORA Lorenzo	ITA	0.57	<b>25.17</b>	0.17
4	5	SPANOUKAKIS Georgios	GRE	0.58	<b>25.19</b>	0.19
5	2	MAKRYGIANNIS Evangelos	GRE	0.60	<b>25.32</b>	0.32
6	3	MARTOS BACARIZO Manuel	ESP	0.52	<b>25.42</b>	0.42
7	8	NOGUEIRA DA COSTA Joao	POR	0.63	<b>25.62</b>	0.62
8	1	TEKIN Doruk	TUR	0.59	<b>25.69</b>	0.69

Issued: 03/07/2022 at 18:30



# Swimming



## Results

### Event 19

03/07/2022 - 10:54

### 50m Backstroke Men Preliminary

RANK	LANE	SURNAME & NAME	NOC	BORN	R.T.	TIME	GAP	FINA PTS
WR	23.71	ARMSTRONG HUNTER	USA					2022
CR	24.73	ASHWIN WILDEBOER FABER	ESP					2009
WJ	21.75	ANDREW MICHAEL C	USA					2017

#### Heat 1 of 3

1	4	SEGURA GUTIERREZ Juan	ESP		0.52	25.42		q
2	5	MAKRYGIANNIS Evangelos	GRE		0.58	25.48	0.06	q
3	6	CHOUCHAOUI Mathys	FRA		0.61	25.94	0.52	R2
4	3	ARDJOUNE Abdellah	ALG		0.61	25.98	0.56	
5	2	BENBARA Mehdi-Nazim	ALG		0.59	26.77	1.35	
6	7	PELEGRINA CUEN Patrick	AND		0.59	27.46	2.04	

Issued: 03/07/2022 at 10:33

#### Heat 2 of 3

1	4	STEFANTH Simone	ITA		0.56	25.17		q
2	6	SPANOUKAKIS Georgios	GRE		0.60	25.20	0.03	q
3	3	MARTOS BACARIZO Manuel	ESP		0.50	25.41	0.24	q
4	5	TEKIN Doruk	TUR		0.62	25.75	0.58	q
5	2	MOUGIS Sofoklis	CYP		0.59	26.50	1.33	
6	7	STOJANOVSKI Andrej	MKD		0.70	27.71	2.54	

Issued: 03/07/2022 at 10:49

#### Heat 3 of 3

1	5	MORA Lorenzo	ITA		0.57	25.54		q
2	3	NOGUEIRA DA COSTA Joao	POR		0.58	25.78	0.24	q
3	4	MANACAS SILVA SANTOS Al.	POR		0.59	25.91	0.37	R1
4	7	BRUN Christophe Pierre	FRA		0.59	26.54	1.00	
5	2	IAKOVIDIS Filippas	CYP		0.67	26.55	1.01	
6	1	VOGLI Frenkli	ALB		0.55	27.99	2.45	

NOT CLASSIFIED

6	BOSKAN Saso	SLO					DNS	
---	-------------	-----	--	--	--	--	-----	--

Issued: 03/07/2022 at 10:50



# Swimming



## Results

RANK HEAT LANE SURNAME & NAME NOC BORN R.T. TIME GAP FINA PTS

### Event 19

03/07/2022 - 10:54

### 50m Backstroke Men Preliminary

WR	23.71	ARMSTRONG HUNTER	USA	2022
CR	24.73	ASHWIN WILDEBOER FABER	ESP	2009
WJ	21.75	ANDREW MICHAEL C	USA	2017

1	2	4	STEFANTH Simone	ITA	0.56	<b>25.17</b>		q
2	2	6	SPANOUKAKIS Georgios	GRE	0.60	<b>25.20</b>	0.03	q
3	2	3	MARTOS BACARIZO Manuel	ESP	0.50	<b>25.41</b>	0.24	q
4	1	4	SEGURA GUTIERREZ Juan	ESP	0.52	<b>25.42</b>	0.25	q
5	1	5	MAKRYGIANNIS Evangelos	GRE	0.58	<b>25.48</b>	0.31	q
6	3	5	MORA Lorenzo	ITA	0.57	<b>25.54</b>	0.37	q
7	2	5	TEKIN Doruk	TUR	0.62	<b>25.75</b>	0.58	q
8	3	3	NOGUEIRA DA COSTA Joao	POR	0.58	<b>25.78</b>	0.61	q
9	3	4	MANACAS SILVA SANTOS Al.	POR	0.59	<b>25.91</b>	0.74	R1
10	1	6	CHOUCHAOUI Mathys	FRA	0.61	<b>25.94</b>	0.77	R2
11	1	3	ARDJOUNE Abdellah	ALG	0.61	<b>25.98</b>	0.81	
12	2	2	MOUGIS Sofoklis	CYP	0.59	<b>26.50</b>	1.33	
13	3	7	BRUN Christophe Pierre	FRA	0.59	<b>26.54</b>	1.37	
14	3	2	IAKOVIDIS Filippos	CYP	0.67	<b>26.55</b>	1.38	
15	1	2	BENBARA Mehdi-Nazim	ALG	0.59	<b>26.77</b>	1.60	
16	1	7	PELEGRINA CUEN Patrick	AND	0.59	<b>27.46</b>	2.29	
17	2	7	STOJANOVSKI Andrej	MKD	0.70	<b>27.71</b>	2.54	
18	3	1	VOGLI Frenkii	ALB	0.55	<b>27.99</b>	2.82	

NOT CLASSIFIED

3 6 BOSKAN Saso SLO DNS

Issued: 03/07/2022 at 10:50



# Swimming



## Results

### Event 6

01/07/2022 - 18:50

### 100m Backstroke Men Final

WR	51.60	CECCON THOMAS	ITA	2022
CR	52.38	ASHWIN WILDEBOER FABER	ESP	2009

### Final

RANK	LANE	SURNAME & NAME	NOC	BORN	R.T.	50m	TIME	GAP	FINA PTS
1	5	MAKRYGIANNIS Evangelos	GRE		0.67	26.12	<b>54.35</b> 28.23		
2	6	MORA Lorenzo	ITA		0.57	26.37	<b>54.50</b> 28.13	0.15	
3	4	HUILLE Stanislas Franck	FRA		0.59	26.53	<b>54.66</b> 28.13	0.31	
4	2	NOGUEIRA DA COSTA Joaao	POR		0.68	26.75	<b>54.69</b> 27.94	0.34	
5	3	CHOUCHAOUI Mathys	FRA		0.76	27.20	<b>54.84</b> 27.64	0.49	
6	7	ARAUZ CONESA Javier	ESP		0.64	26.49	<b>55.05</b> 28.56	0.70	
7	8	MIRA ALBALADEJO Diego	ESP		0.62	26.91	<b>55.59</b> 28.68	1.24	
8	1	ARDJOUNE Abdellah	ALG		0.57	26.58	<b>55.82</b> 29.24	1.47	

Issued: 01/07/2022 at 19:24





# Swimming



## Results

Event 6  
01/07/2022 - 10:55

### 100m Backstroke Men Preliminary

WR	51.60	CECCON THOMAS	ITA	2022
CR	52.38	ASHWIN WILDEBOER FABER	ESP	2009

#### Heat 1 of 3

RANK	LANE	SURNAME & NAME	NOC	BORN	R.T.	50m	TIME	GAP	FINA PTS
1	4	MAKRYGIANNIS Evangelos	GRE		0.66	26.66	<b>55.02</b> 28.36		q
2	3	CHOUCHAOUI Mathys	FRA		0.62	26.93	<b>55.05</b> 28.12	0.03	q
3	6	BOSKAN Saso	SLO		0.59	26.99	<b>56.07</b> 29.08	1.05	
4	5	MARIC Ognjen	CRO		0.57	27.27	<b>56.76</b> 29.49	1.74	
5	2	SENICA PAVLETIC Primoz	SLO		0.64	27.73	<b>57.13</b> 29.40	2.11	
6	7	VOGLI Frenkli	ALB		0.71	29.29	<b>1:00.50</b> 31.21	5.48	

Issued: 01/07/2022 at 11:00

#### Heat 2 of 3

1	3	HUILLE Stanislas Franck	FRA		0.61	26.39	<b>54.73</b> 28.34		q
2	6	ARAUZ CONESA Javier	ESP		0.61	26.92	<b>55.41</b> 28.49	0.68	q
3	2	ARDJOUNE Abdellah	ALG		0.58	26.45	<b>55.50</b> 29.05	0.77	q
4	7	SPANOUKAKIS Georgios	GRE		0.60	26.26	<b>55.60</b> 29.34	0.87	R1
5	5	RESTIVO Matteo	ITA		0.57	27.39	<b>55.88</b> 28.49	1.15	R2
6	4	SANTOS Francisco Rog,Rio	POR		0.65	27.11	<b>56.39</b> 29.28	1.66	

Issued: 01/07/2022 at 11:01

#### Heat 3 of 3

1	5	MORA Lorenzo	ITA		0.63	26.37	<b>55.09</b> 28.72		q
2	4	NOGUEIRA DA COSTA Joaao	POR		0.64	27.15	<b>55.40</b> 28.25	0.31	q
3	6	MIRA ALBALADEJO Diego	ESP		0.61	27.01	<b>55.52</b> 28.51	0.43	q
4	3	SAKA Berke	TUR		0.78	26.76	<b>56.18</b> 29.42	1.09	
5	7	MOUGIS Sofoklis	CYP		0.59	28.10	<b>58.01</b> 29.91	2.92	
6	2	IAKOVIDIS Filippas	CYP		0.90	27.68	<b>58.19</b> 30.51	3.10	



# Swimming



## Results

RANK HEAT LANE SURNAME & NAME NOC BORN R.T. 50m TIME GAP FINA PTS

### Event 6

01/07/2022 - 10:55

### 100m Backstroke Men Preliminary

WR	51.60	CECCON THOMAS	ITA	2022
CR	52.38	ASHWIN WILDEBOER FABER	ESP	2009

1	2	3	HUILLE Stanislas Franck	FRA	0.61	26.39	<b>54.73</b> 28.34		q
2	1	4	MAKRYGIANNIS Evangelos	GRE	0.66	26.66	<b>55.02</b> 28.36	0.29	q
3	1	3	CHOUCHAOUI Mathys	FRA	0.62	26.93	<b>55.05</b> 28.12	0.32	q
4	3	5	MORA Lorenzo	ITA	0.63	26.37	<b>55.09</b> 28.72	0.36	q
5	3	4	NOGUEIRA DA COSTA Joaao	POR	0.64	27.15	<b>55.40</b> 28.25	0.67	q
6	2	6	ARAUZ CONESA Javier	ESP	0.61	26.92	<b>55.41</b> 28.49	0.68	q
7	2	2	ARDJOUNE Abdellah	ALG	0.58	26.45	<b>55.50</b> 29.05	0.77	q
8	3	6	MIRA ALBALADEJO Diego	ESP	0.61	27.01	<b>55.52</b> 28.51	0.79	q
9	2	7	SPANOUKAKIS Georgios	GRE	0.60	26.26	<b>55.60</b> 29.34	0.87	R1
10	2	5	RESTIVO Matteo	ITA	0.57	27.39	<b>55.88</b> 28.49	1.15	R2
11	1	6	BOSKAN Saso	SLO	0.59	26.99	<b>56.07</b> 29.08	1.34	
12	3	3	SAKA Berke	TUR	0.78	26.76	<b>56.18</b> 29.42	1.45	
13	2	4	SANTOS Francisco Rog,Rio	POR	0.65	27.11	<b>56.39</b> 29.28	1.66	
14	1	5	MARIC Ognjen	CRO	0.57	27.27	<b>56.76</b> 29.49	2.03	
15	1	2	SENICA PAVLETIC Primoz	SLO	0.64	27.73	<b>57.13</b> 29.40	2.40	
16	3	7	MOUGIS Sofoklis	CYP	0.59	28.10	<b>58.01</b> 29.91	3.28	
17	3	2	IAKOVIDIS Filippos	CYP	0.90	27.68	<b>58.19</b> 30.51	3.46	
18	1	7	VOGLI Frenkli	ALB	0.71	29.29	<b>1:00.50</b> 31.21	5.77	

Issued: 01/07/2022 at 11:06



# Swimming



## Results

RANK	LANE	SURNAME & NAME	NOC	BORN	R.T.	50m	100m	150m	TIME	GAP	FINA PTS
------	------	----------------	-----	------	------	-----	------	------	------	-----	-------------

### Event 37

05/07/2022 - 19:18

## 200m Backstroke Men Final

WR	1:51.92	PEIRSOL AARON	USA	2009
CR	1:54.96	ASHWIN WILDEBOER FABER	ESP	2009
JR	1:55.14	KOLESNIKOV KLIMENT	RUS	2017

### Final

1	3	MORA Lorenzo	ITA	0.61	27.84	57.85 30.01	1:27.92 30.07	<b>1:57.62</b> 29.70	
2	6	RESTIVO Matteo	ITA	0.57	27.61	57.28 29.67	1:27.33 30.05	<b>1:57.77</b> 30.44	0.15
3	4	BRUN Christophe Pierre	FRA	0.59	28.36	58.51 30.15	1:28.81 30.30	<b>1:58.40</b> 29.59	0.78
4	1	CHOUCHAOUI Mathys	FRA	0.65	28.66	59.58 30.92	1:31.01 31.43	<b>2:00.11</b> 29.10	2.49
5	7	SENICA PAVLETIC Primoz	SLO	0.65	28.50	58.83 30.33	1:29.89 31.06	<b>2:00.51</b> 30.62	2.89
6	2	MIRA ALBALADEJO Diego	ESP	0.58	27.88	58.13 30.25	1:29.10 30.97	<b>2:00.63</b> 31.53	3.01
7	8	ARAUZ CONESA Javier	ESP	0.59	28.13	58.16 30.03	1:29.18 31.02	<b>2:00.83</b> 31.65	3.21
8	5	FERS ERZEN Anze	SLO	0.77	28.76	59.13 30.37	1:30.61 31.48	<b>2:00.85</b> 30.24	3.23

Issued: 05/07/2022 at 19:23



# Swimming



## Results

Event 37  
05/07/2022 - 11:31

### 200m Backstroke Men Preliminary

RANK	LANE	SURNAME & NAME	NOC	BORN	R.T.	50m	100m	150m	TIME	GAP	FINA PTS
WR	1:51.92	PEIRSOL AARON	USA								2009
CR	1:54.96	ASHWIN WILDEBOER FABER	ESP								2009
JR	1:55.14	KOLESNIKOV KLIMENT	RUS								2017

#### Heat 1 of 2

1	7	FERS ERZEN Anze	SLO		0.79	28.29	58.11 29.82	1:29.12 31.01	<b>2:00.35</b> 31.23		q
2	5	RESTIVO Matteo	ITA		0.60	27.76	57.58 29.82	1:28.93 31.35	<b>2:00.66</b> 31.73	0.31	q
3	2	MIRA ALBALADEJO Diego	ESP		0.60	28.07	58.19 30.12	1:29.02 30.83	<b>2:00.96</b> 31.94	0.61	q
4	6	SENICA PAVLETIC Primoz	SLO		0.67	29.00	58.95 29.95	1:30.09 31.14	<b>2:01.32</b> 31.23	0.97	q
5	4	SAKA Berke	TUR		0.70	28.20	58.94 30.74	1:30.85 31.91	<b>2:02.74</b> 31.89	2.39	
6	3	NOGUEIRA DA COSTA Joao	POR		0.66	28.53	1:00.55 32.02	1:33.10 32.55	<b>2:03.23</b> 30.13	2.88	
7	1	MARIC Ognjen	CRO		0.57	29.20	1:01.25 32.05	1:32.63 31.38	<b>2:04.29</b> 31.66	3.94	

Issued: 05/07/2022 at 11:18

#### Heat 2 of 2

1	6	BRUN Christophe Pierre	FRA		0.62	28.62	59.11 30.49	1:29.85 30.74	<b>1:59.78</b> 29.93		q
2	5	MORA Lorenzo	ITA		0.64	28.46	59.06 30.60	1:29.91 30.85	<b>2:00.66</b> 30.75	0.88	q
3	2	CHOUCHAOU Mathys	FRA		0.62	28.03	59.65 31.62	1:30.96 31.31	<b>2:01.47</b> 30.51	1.69	q
4	7	ARAUZ CONESA Javier	ESP		0.61	28.83	59.47 30.64	1:30.53 31.06	<b>2:01.64</b> 31.11	1.86	q
5	3	MAKRYGIANNIS Evangelos	GRE		0.63	28.28	59.57 31.29	1:31.30 31.73	<b>2:01.75</b> 30.45	1.97	R1
6	4	SANTOS Francisco	POR		0.65	27.95	59.24 31.29	1:30.94 31.70	<b>2:02.13</b> 31.19	2.35	R2
7	1	ARDJOUNE Abdellah	ALG		0.62	28.19	59.56 31.37	1:31.23 31.67	<b>2:04.18</b> 32.95	4.40	
8	8	VOGLI Frenkli	ALB		0.58	30.09	1:03.08 32.99	1:38.10 35.02	<b>2:14.20</b> 36.10	14.42	

Issued: 05/07/2022 at 11:25



# Swimming



## Results

RANK	HEAT	LANE	SURNAME & NAME	NOC	BORN	R.T.	50m	100m	150m	TIME	GAP	FINA PTS
------	------	------	----------------	-----	------	------	-----	------	------	------	-----	-------------

### Event 37

05/07/2022 - 11:31

## 200m Backstroke Men Preliminary

WR	1:51.92	PEIRSOL AARON	USA	2009
CR	1:54.96	ASHWIN WILDEBOER FABER	ESP	2009
JR	1:55.14	KOLESNIKOV KLIMENT	RUS	2017

1	2	6	BRUN Christophe Pierre	FRA		0.62	28.62	59.11 30.49	1:29.85 30.74	<b>1:59.78</b> 29.93		q
2	1	7	FERS ERZEN Anze	SLO		0.79	28.29	58.11 29.82	1:29.12 31.01	<b>2:00.35</b> 31.23	0.57	q
3	2	5	MORA Lorenzo	ITA		0.64	28.46	59.06 30.60	1:29.91 30.85	<b>2:00.66</b> 30.75	0.88	q
3	1	5	RESTIVO Matteo	ITA		0.60	27.76	57.58 29.82	1:28.93 31.35	<b>2:00.66</b> 31.73	0.88	q
5	1	2	MIRA ALBALADEJO Diego	ESP		0.60	28.07	58.19 30.12	1:29.02 30.83	<b>2:00.96</b> 31.94	1.18	q
6	1	6	SENICA PAVLETIC Primoz	SLO		0.67	29.00	58.95 29.95	1:30.09 31.14	<b>2:01.32</b> 31.23	1.54	q
7	2	2	CHOUCHAOU Mathys	FRA		0.62	28.03	59.65 31.62	1:30.96 31.31	<b>2:01.47</b> 30.51	1.69	q
8	2	7	ARAUZ CONESA Javier	ESP		0.61	28.83	59.47 30.64	1:30.53 31.06	<b>2:01.64</b> 31.11	1.86	q
9	2	3	MAKRYGIANNIS Evangelos	GRE		0.63	28.28	59.57 31.29	1:31.30 31.73	<b>2:01.75</b> 30.45	1.97	R1
10	2	4	SANTOS Francisco	POR		0.65	27.95	59.24 31.29	1:30.94 31.70	<b>2:02.13</b> 31.19	2.35	R2
11	1	4	SAKA Berke	TUR		0.70	28.20	58.94 30.74	1:30.85 31.91	<b>2:02.74</b> 31.89	2.96	
12	1	3	NOGUEIRA DA COSTA Joao	POR		0.66	28.53	1:00.55 32.02	1:33.10 32.55	<b>2:03.23</b> 30.13	3.45	
13	2	1	ARDJOUNE Abdellah	ALG		0.62	28.19	59.56 31.37	1:31.23 31.67	<b>2:04.18</b> 32.95	4.40	
14	1	1	MARIC Ognjen	CRO		0.57	29.20	1:01.25 32.05	1:32.63 31.38	<b>2:04.29</b> 31.66	4.51	
15	2	8	VOGLI Frenkli	ALB		0.58	30.09	1:03.08 32.99	1:38.10 35.02	<b>2:14.20</b> 36.10	14.42	

Issued: 05/07/2022 at 11:25



# Swimming



## Results

RANK LANE SURNAME & NAME NOC BORN R.T. TIME GAP FINA PTS

### Event 10

02/07/2022 - 18:04

### 50m Breaststroke Men Final

WR	25.95	PEATY ADAM	GBR	2017
CR	27.17	*SCOZZOLI Fabio	ITA	02/07/2022
WJ	26.97	MARTINENGI NICOLO'	ITA	2017

### Final

1	4	SCOZZOLI Fabio	ITA	0.64	<b>26.97</b>		CR
2	5	SAKCI H.Emre	TUR	0.61	<b>27.00</b>	0.03	
3	6	STEVENS Peter John	SLO	0.58	<b>27.46</b>	0.49	
4	7	PINZUTI Alessandro	ITA	0.69	<b>27.55</b>	0.58	
5	3	MERETSOLIAS Konstantinos	GRE	0.63	<b>27.93</b>	0.96	
6	2	OGRETIR Berkay O.	TUR	0.65	<b>28.00</b>	1.03	
7	8	VALOUR Julien Laurent	FRA	0.65	<b>28.28</b>	1.31	
8	1	MAILLOT Melvin	FRA	0.67	<b>28.33</b>	1.36	

Issued: 02/07/2022 at 18:10



# Swimming



## Results

RANK LANE SURNAME & NAME NOC BORN R.T. TIME GAP FINA PTS

### Event 10

02/07/2022 - 10:10

### 50m Breaststroke Men Preliminary

WR	25.95	PEATY ADAM	GBR	2017
CR	27.22	ALESSANDRO TERRIN	ITA	2009
WJ	26.97	MARTINENGGHI NICOLO'	ITA	2017

#### Heat 1 of 3

1	5	MERETSOLIAS Konstantinos	GRE		27.65		q
2	4	STEVENS Peter John	SLO		27.70	0.05	q
3	6	MANACAS SILVA SANTOS Al.	POR		28.65	1.00	R1
4	3	PANARETOS Panayiotis	CYP		29.01	1.36	
5	2	BOUZOUIA Youcef	ALG		30.48	2.83	

Issued: 02/07/2022 at 10:11

#### Heat 2 of 3

1	4	SCOZZOLI Fabio	ITA	0.65	27.17		q CR
2	5	PINZUTI Alessandro	ITA	0.71	27.82	0.65	q
3	3	VALOUR Julien Laurent	FRA	0.66	28.50	1.33	q
4	6	THOMOGLLOU Savvas	GRE	0.69	28.68	1.51	R2
5	7	PELEGRINA CUEN Patrick	AND	0.63	28.85	1.68	
6	2	BALAMANE Moncef Aymen	ALG	0.64	28.90	1.73	

Issued: 02/07/2022 at 10:14

#### Heat 3 of 3

1	4	SAKCI H.Emre	TUR	0.61	27.46		q
2	5	OGRETIR Berkay O.	TUR	0.62	27.80	0.34	q
3	3	MAILLOT Melvin	FRA	0.64	28.12	0.66	q
4	2	DE OLIVEIRA ROBALO Q.	POR	0.63	28.91	1.45	
5	6	IAKOVIDIS Markos	CYP	0.71	29.03	1.57	
6	7	CASADEI Giacomo	SMR	0.70	29.49	2.03	

Issued: 02/07/2022 at 10:17



# Swimming



## Results

RANK HEAT LANE SURNAME & NAME NOC BORN R.T. TIME GAP FINA PTS

### Event 10

02/07/2022 - 10:10

### 50m Breaststroke Men Preliminary

WR	25.95	PEATY ADAM	GBR	2017					
CR	27.22	ALESSANDRO TERRIN	ITA	2009					
WJ	26.97	MARTINENGGHI NICOLO'	ITA	2017					
1	2	4	<b>SCOZZOLI Fabio</b>	ITA	0.65	<b>27.17</b>		q	CR
2	3	4	<b>SAKCI H.Emre</b>	TUR	0.61	<b>27.46</b>	0.29	q	
3	1	5	<b>MERETSOLIAS Konstantinos</b>	GRE		<b>27.65</b>	0.48	q	
4	1	4	<b>STEVENS Peter John</b>	SLO		<b>27.70</b>	0.53	q	
5	3	5	<b>OGRETIR Berkay O.</b>	TUR	0.62	<b>27.80</b>	0.63	q	
6	2	5	<b>PINZUTI Alessandro</b>	ITA	0.71	<b>27.82</b>	0.65	q	
7	3	3	<b>MAILLOT Melvin</b>	FRA	0.64	<b>28.12</b>	0.95	q	
8	2	3	<b>VALOUR Julien Laurent</b>	FRA	0.66	<b>28.50</b>	1.33	q	
9	1	6	<b>MANACAS SILVA SANTOS Al.</b>	POR		<b>28.65</b>	1.48	R1	
10	2	6	<b>THOMOGLOU Savvas</b>	GRE	0.69	<b>28.68</b>	1.51	R2	
11	2	7	<b>PELEGRINA CUEN Patrick</b>	AND	0.63	<b>28.85</b>	1.68		
12	2	2	<b>BALAMANE Moncef Aymen</b>	ALG	0.64	<b>28.90</b>	1.73		
13	3	2	<b>DE OLIVEIRA ROBALO Q.</b>	POR	0.63	<b>28.91</b>	1.74		
14	1	3	<b>PANARETOS Panayiotis</b>	CYP		<b>29.01</b>	1.84		
15	3	6	<b>IAKOVIDIS Markos</b>	CYP	0.71	<b>29.03</b>	1.86		
16	3	7	<b>CASADEI Giacomo</b>	SMR	0.70	<b>29.49</b>	2.32		
17	1	2	<b>BOUZOUIA Youcef</b>	ALG		<b>30.48</b>	3.31		

Issued: 02/07/2022 at 10:17





# Swimming



## Results

RANK	LANE	SURNAME & NAME	NOC	BORN	R.T.	50m	TIME	GAP	FINA PTS
------	------	----------------	-----	------	------	-----	------	-----	-------------

Event 35  
05/07/2022 - 18:50

### 100m Breaststroke Men Final

WR	56.88	PEATY ADAM	GBR	2019
CR	1:00.45	MELQUIADES ALVAREZ	ESP	2009
JR	59.01	MARTINENGGHI NICOLO'	ITA	2017

#### Final

1	4	OGRETIR Berkay O.	TUR	0.64	28.31	<b>1:00.03</b> 31.72		CR
2	7	SAKCI H.Emre	TUR	0.63	27.96	<b>1:00.19</b> 32.23	0.16	
3	5	PINZUTI Alessandro	ITA	0.68	28.14	<b>1:00.31</b> 32.17	0.28	
4	3	BIDARD Clement	FRA	0.68	28.84	<b>1:01.17</b> 32.33	1.14	
5	6	MERETSOLIAS Konstantinos	GRE	0.63	28.91	<b>1:01.70</b> 32.79	1.67	
6	2	MARC Antoine Laurent	FRA	0.65	29.27	<b>1:01.85</b> 32.58	1.82	
7	1	THOMOGLLOU Savvas	GRE	0.67	29.26	<b>1:02.08</b> 32.82	2.05	
8	8	FUSCO Alessandro	ITA	0.64	29.46	<b>1:02.26</b> 32.80	2.23	

Issued: 05/07/2022 at 18:55



# Swimming



## Results

Event 35  
05/07/2022 - 11:11

### 100m Breaststroke Men Preliminary

RANK	LANE	SURNAME & NAME	NOC	BORN	R.T.	50m	TIME	GAP	FINA PTS
WR	56.88	PEATY ADAM	GBR						2019
CR	1:00.45	MELQUIADES ALVAREZ	ESP						2009
JR	59.01	MARTINENGGHI NICOLO'	ITA						2017

#### Heat 1 of 3

1	5	BIDARD Clement	FRA		0.72	29.05	<b>1:01.82</b> 32.77		q
2	4	MERETSOLIAS Konstantinos	GRE		0.64	29.04	<b>1:02.12</b> 33.08	0.30	q
3	3	MARC Antoine Laurent	FRA		0.66	29.24	<b>1:02.13</b> 32.89	0.31	q
4	2	CASADEI Giacomo	SMR		0.70	30.25	<b>1:04.52</b> 34.27	2.70	
5	6	CASTEJON I RAMIREZ Alex	ESP		0.66	30.25	<b>1:04.55</b> 34.30	2.73	

Issued: 05/07/2022 at 10:54

#### Heat 2 of 3

1	4	SAKCI H.Emre	TUR		0.63	28.56	<b>1:02.17</b> 33.61		q
2	5	THOMOGLU Savvas	GRE		0.67	29.61	<b>1:02.41</b> 32.80	0.24	q
3	3	FUSCO Alessandro	ITA		0.64	29.20	<b>1:02.44</b> 33.24	0.27	q
4	2	ALMEIDA LOPES Gabriel	POR		0.63	29.69	<b>1:03.20</b> 33.51	1.03	
5	7	PELEGRINA CUEN Patrick	AND		0.64	29.71	<b>1:03.82</b> 34.11	1.65	
6	6	STEVENS Peter John	SLO		0.61	29.53	<b>1:03.96</b> 34.43	1.79	

Issued: 05/07/2022 at 10:59

#### Heat 3 of 3

1	4	OGRETIR Berkay O.	TUR		0.65	28.96	<b>1:01.06</b> 32.10		q
2	5	PINZUTI Alessandro	ITA		0.71	29.03	<b>1:01.50</b> 32.47	0.44	q
3	2	BALAMANE Moncef Aymen	ALG		0.64	29.43	<b>1:02.82</b> 33.39	1.76	R1
4	3	DE OLIVEIRA Francisco	POR		0.62	29.43	<b>1:02.86</b> 33.43	1.80	R2
5	6	PANARETOS Panayiotis	CYP		0.67	29.56	<b>1:03.48</b> 33.92	2.42	
6	7	CHOUCHAR Ramzi	ALG		0.64	31.35	<b>1:05.91</b> 34.56	4.85	

Issued: 05/07/2022 at 11:03



# Swimming



## Results

RANK HEAT LANE SURNAME & NAME NOC BORN R.T. 50m TIME GAP FINA PTS

### Event 35

05/07/2022 - 11:11

### 100m Breaststroke Men Preliminary

WR	56.88	PEATY ADAM	GBR	2019
CR	1:00.45	MELQUIADES ALVAREZ	ESP	2009
JR	59.01	MARTINENGGHI NICOLO'	ITA	2017

1	3	4	OGRETIR Berkay O.	TUR	0.65	28.96	<b>1:01.06</b> 32.10		q
2	3	5	PINZUTI Alessandro	ITA	0.71	29.03	<b>1:01.50</b> 32.47	0.44	q
3	1	5	BIDARD Clement	FRA	0.72	29.05	<b>1:01.82</b> 32.77	0.76	q
4	1	4	MERETSOLIAS Konstantinos	GRE	0.64	29.04	<b>1:02.12</b> 33.08	1.06	q
5	1	3	MARC Antoine Laurent	FRA	0.66	29.24	<b>1:02.13</b> 32.89	1.07	q
6	2	4	SAKCI H.Emre	TUR	0.63	28.56	<b>1:02.17</b> 33.61	1.11	q
7	2	5	THOMOGLU Savvas	GRE	0.67	29.61	<b>1:02.41</b> 32.80	1.35	q
8	2	3	FUSCO Alessandro	ITA	0.64	29.20	<b>1:02.44</b> 33.24	1.38	q
9	3	2	BALAMANE Moncef Aymen	ALG	0.64	29.43	<b>1:02.82</b> 33.39	1.76	R1
10	3	3	DE OLIVEIRA Francisco	POR	0.62	29.43	<b>1:02.86</b> 33.43	1.80	R2
11	2	2	ALMEIDA LOPES Gabriel	POR	0.63	29.69	<b>1:03.20</b> 33.51	2.14	
12	3	6	PANARETOS Panayiotis	CYP	0.67	29.56	<b>1:03.48</b> 33.92	2.42	
13	2	7	PELEGRINA CUEN Patrick	AND	0.64	29.71	<b>1:03.82</b> 34.11	2.76	
14	2	6	STEVENS Peter John	SLO	0.61	29.53	<b>1:03.96</b> 34.43	2.90	
15	1	2	CASADEI Giacomo	SMR	0.70	30.25	<b>1:04.52</b> 34.27	3.46	
16	1	6	CASTEJON I RAMIREZ Alex	ESP	0.66	30.25	<b>1:04.55</b> 34.30	3.49	
17	3	7	CHOUCAR Ramzi	ALG	0.64	31.35	<b>1:05.91</b> 34.56	4.85	

Issued: 05/07/2022 at 11:03



# Swimming



## Results

RANK	LANE	SURNAME & NAME	NOC	BORN	R.T.	50m	100m	150m	TIME	GAP	FINA PTS
------	------	----------------	-----	------	------	-----	------	------	------	-----	-------------

### Event 4

01/07/2022 - 18:35

## 200m Breaststroke Men Final

WR	1:51.92	STUBBLETY -COOK ZAC	AUS	2009
CR	2:09.69	MELQUIADES ALVAREZ	ESP	2009

### Final

1	4	OGRETIR Berkay O.	TUR	0.66	29.23	1:01.74 32.51	1:35.58 33.84	<b>2:11.26</b> 35.68	
2	3	MARC Antoine Laurent Jac	FRA	0.68	30.07	1:03.94 33.87	1:38.57 34.63	<b>2:12.55</b> 33.98	1.29
3	5	CASTEJON I RAMIREZ Alex	ESP	0.70	30.39	1:03.95 33.56	1:38.20 34.25	<b>2:12.60</b> 34.40	1.34
4	2	THOMOGLOU Savvas	GRE	0.69	30.23	1:04.23 34.00	1:38.67 34.44	<b>2:13.28</b> 34.61	2.02
5	6	ALMEIDA LOPES Gabriel Jo	POR	0.60	29.51	1:02.74 33.23	1:37.21 34.47	<b>2:13.64</b> 36.43	2.38
6	7	FUSCO Alessandro	ITA	0.65	29.74	1:04.03 34.29	1:39.04 35.01	<b>2:15.38</b> 36.34	4.12
7	1	LE PAPE Thomas Yoann	FRA	0.66	30.39	1:04.98 34.59	1:39.89 34.91	<b>2:15.50</b> 35.61	4.24
8	8	SORRISO Giovanni	ITA	0.67	30.72	1:05.06 34.34	1:40.09 35.03	<b>2:15.90</b> 35.81	4.64

Issued: 01/07/2022 at 20:03



# Swimming



## Results

RANK	LANE	SURNAME & NAME	NOC	BORN	R.T.	50m	100m	150m	TIME	GAP	FINA PTS
------	------	----------------	-----	------	------	-----	------	------	------	-----	-------------

### Event 4

01/07/2022 - 10:39

## 200m Breaststroke Men Preliminary

WR	1:51.92	STUBBLETY -COOK ZAC							AUS		2009
CR	2:09.69	MELQUIADES ALVAREZ							ESP		2009

### Heat 1 of 3

1	6	ALMEIDA LOPES Gabriel Jo	POR		0.62	30.44	1:04.63 34.19	1:39.56 34.93	<b>2:15.24</b> 35.68		q
2	4	FUSCO Alessandro	ITA		0.65	31.10	1:05.90 34.80	1:40.98 35.08	<b>2:16.22</b> 35.24	0.98	q
3	5	LE PAPE Thomas Yoann	FRA		0.66	30.65	1:05.59 34.94	1:40.97 35.38	<b>2:16.25</b> 35.28	1.01	q
4	2	DE OLIVEIRA ROBALO QUINT	POR		0.64	31.69	1:06.99 35.30	1:42.03 35.04	<b>2:17.19</b> 35.16	1.95	R1
5	3	CHOUCHAR Ramzi	ALG		0.63	31.22	1:06.14 34.92	1:41.54 35.40	<b>2:17.61</b> 36.07	2.37	R2

Issued: 01/07/2022 at 10:40

### Heat 2 of 3

1	5	MARC Antoine Laurent Jac	FRA		0.77	30.68	1:05.08 34.40	1:40.21 35.13	<b>2:14.94</b> 34.73		q
2	4	THOMOGLU Savvas	GRE		0.68	30.66	1:05.63 34.97	1:41.04 35.41	<b>2:15.87</b> 34.83	0.93	q
3	3	SORRISO Giovanni	ITA		0.69	30.87	1:05.85 34.98	1:40.99 35.14	<b>2:16.58</b> 35.59	1.64	q
4	6	BALAMANE Moncef Aymen	ALG		0.65	30.99	1:05.87 34.88	1:42.39 36.52	<b>2:20.03</b> 37.64	5.09	
5	2	STOJANOVSKI Andrej	MKD		0.72	32.14	1:08.90 36.76	1:45.92 37.02	<b>2:22.42</b> 36.50	7.48	

NOT CLASSIFIED

7		AL SHARIF Siraj	LBA								DNS
---	--	-----------------	-----	--	--	--	--	--	--	--	-----

Issued: 01/07/2022 at 10:45

### Heat 3 of 3

1	4	OGRETIR Berkay O.	TUR		0.69	29.88	1:03.94 34.06	1:38.08 34.14	<b>2:12.62</b> 34.54		q
2	5	CASTEJON I RAMIREZ Alex	ESP		0.69	30.47	1:04.22 33.75	1:38.56 34.34	<b>2:12.73</b> 34.17	0.11	q
3	2	CASADEI Giacomo	SMR		0.73	31.65	1:07.70 36.05	1:44.33 36.63	<b>2:20.31</b> 35.98	7.69	
4	3	MERETSOLIAS Konstantinos	GRE		0.68	31.20	1:07.55 36.35	1:44.52 36.97	<b>2:20.38</b> 35.86	7.76	
5	6	KORKMAZ Kaan	TUR		0.69	32.02	1:08.12 36.10	1:45.28 37.16	<b>2:22.80</b> 37.52	10.18	

NOT CLASSIFIED

7		ASHOUR Abdulhay	LBA								DNS
---	--	-----------------	-----	--	--	--	--	--	--	--	-----

Issued: 01/07/2022 at 10:50

SWMM200MBR-----HEAT-----\_73A2 2.0

Data Processing and Timing by Microplus Timing

Report Created 01 JUL 2022 at 15:55

Page 1





# Swimming



## Results

RANK HEAT LANE SURNAME & NAME NOC BORN R.T. 50m 100m 150m TIME GAP FINA PTS

### Event 4

01/07/2022 - 10:39

### 200m Breaststroke Men Preliminary

WR CR	1:51.92	STUBBLETY -COOK ZAC	AUS	2009							
	2:09.69	MELQUIADES ALVAREZ	ESP	2009							
1	3	4	<b>OGRETIR Berkay O.</b>	TUR	0.69	29.88	1:03.94 34.06	1:38.08 34.14	<b>2:12.62</b> 34.54		q
2	3	5	<b>CASTEJON I RAMIREZ Alex</b>	ESP	0.69	30.47	1:04.22 33.75	1:38.56 34.34	<b>2:12.73</b> 34.17	0.11	q
3	2	5	<b>MARC Antoine Laurent Jac</b>	FRA	0.77	30.68	1:05.08 34.40	1:40.21 35.13	<b>2:14.94</b> 34.73	2.32	q
4	1	6	<b>ALMEIDA LOPES Gabriel Jo</b>	POR	0.62	30.44	1:04.63 34.19	1:39.56 34.93	<b>2:15.24</b> 35.68	2.62	q
5	2	4	<b>THOMOGLU Savvas</b>	GRE	0.68	30.66	1:05.63 34.97	1:41.04 35.41	<b>2:15.87</b> 34.83	3.25	q
6	1	4	<b>FUSCO Alessandro</b>	ITA	0.65	31.10	1:05.90 34.80	1:40.98 35.08	<b>2:16.22</b> 35.24	3.60	q
7	1	5	<b>LE PAPE Thomas Yoann</b>	FRA	0.66	30.65	1:05.59 34.94	1:40.97 35.38	<b>2:16.25</b> 35.28	3.63	q
8	2	3	<b>SORRISO Giovanni</b>	ITA	0.69	30.87	1:05.85 34.98	1:40.99 35.14	<b>2:16.58</b> 35.59	3.96	q
9	1	2	<b>DE OLIVEIRA ROBALO QUINT</b>	POR	0.64	31.69	1:06.99 35.30	1:42.03 35.04	<b>2:17.19</b> 35.16	4.57	R1
10	1	3	<b>CHOUCHAR Ramzi</b>	ALG	0.63	31.22	1:06.14 34.92	1:41.54 35.40	<b>2:17.61</b> 36.07	4.99	R2
11	2	6	<b>BALAMANE Moncef Aymen</b>	ALG	0.65	30.99	1:05.87 34.88	1:42.39 36.52	<b>2:20.03</b> 37.64	7.41	
12	3	2	<b>CASADEI Giacomo</b>	SMR	0.73	31.65	1:07.70 36.05	1:44.33 36.63	<b>2:20.31</b> 35.98	7.69	
13	3	3	<b>MERETSOLIAS Konstantinos</b>	GRE	0.68	31.20	1:07.55 36.35	1:44.52 36.97	<b>2:20.38</b> 35.86	7.76	
14	2	2	<b>STOJANOVSKI Andrej</b>	MKD	0.72	32.14	1:08.90 36.76	1:45.92 37.02	<b>2:22.42</b> 36.50	9.80	
15	3	6	<b>KORKMAZ Kaan</b>	TUR	0.69	32.02	1:08.12 36.10	1:45.28 37.16	<b>2:22.80</b> 37.52	10.18	

NOT CLASSIFIED

2	7	<b>AL SHARIF Siraj</b>	LBA						<b>DNS</b>	
3	7	<b>ASHOUR Abdulhay</b>	LBA						<b>DNS</b>	

Issued: 01/07/2022 at 10:50

# Swimming



## Results

RANK LANE SURNAME & NAME NOC BORN R.T. TIME GAP FINA PTS

### Event 2

01/07/2022 - 18:04

### 50m Butterfly Men Final

WR	22.27	GOVOROV ANDRY	UKR	2018
CR	23.50	LENDJER Ivan	SRB	2013

### Final

RANK	LANE	SURNAME & NAME	NOC	BORN	R.T.	TIME	GAP	FINA PTS
1	6	DE MATOS RIBEIRO Diogo	POR		0.64	<b>23.38</b>		CR
2	3	RIVOLTA Matteo	ITA		0.65	<b>23.59</b>	0.21	
3	4	GKOLOMEEV Kristian	GRE		0.66	<b>23.61</b>	0.23	
4	5	MOLLA YANES Mario	ESP		0.68	<b>23.70</b>	0.32	
5	2	BILAS Stergios Marios	GRE		0.67	<b>23.71</b>	0.33	
6	1	BEROL Julien Arthur	FRA		0.65	<b>23.87</b>	0.49	
7	7	SAKCI H.Emre	TUR		0.62	<b>23.96</b>	0.58	
8	8	SYOUD Jaouad	ALG		0.64	<b>24.27</b>	0.89	

Issued: 01/07/2022 at 19:17



# Swimming



## Results

Event 2  
01/07/2022 - 10:10

### 50m Butterfly Men Preliminary

WR	22.27	GOVOROV ANDRY	UKR	2018
CR	23.50	IVAN LENDJER	SBR	2013

#### Heat 1 of 3

RANK	LANE	SURNAME & NAME	NOC	BORN	R.T.	TIME	GAP	FINA PTS
1	4	GKOLOMEEV Kristian	GRE		0.69	23.70		q
2	5	BILAS Stergios Marios	GRE		0.73	24.05	0.35	q
3	6	SAKCI H.Emre	TUR		0.61	24.08	0.38	q
4	3	ANDOLFI Gianluca	ITA		0.63	24.26	0.56	
5	7	LOMERO ARENAS Tomas	AND		0.60	24.47	0.77	
6	2	REBOSIO Alessandro	SMR		0.72	26.26	2.56	

Issued: 01/07/2022 at 10:13

#### Heat 2 of 3

1	6	MOLLA YANES Mario	ESP		0.66	23.81		q
2	3	RIVOLTA Matteo	ITA		0.67	23.89	0.08	q
3	4	DE ALMEIDA SILVA DUARTE	POR		0.68	24.20	0.39	R1
4	5	COMTE Serguei Corentin	FRA		0.64	24.57	0.76	
5	2	MARTINEZ NOVOA Miguel	ESP		0.62	24.89	1.08	
6	7	TELAKU Alush	KOS		0.65	26.74	2.93	

Issued: 01/07/2022 at 10:16

#### Heat 3 of 3

1	4	DE MATOS RIBEIRO Diogo	POR		0.64	24.03		q
2	3	BEROL Julien Arthur	FRA			24.09	0.06	q
3	6	SYOUD Jaouad	ALG		0.71	24.15	0.12	q
4	5	GURES Umit Can	TUR		0.66	24.25	0.22	R2
5	2	MATIC Durde	SRB			24.66	0.63	
6	7	BOUZOUIA Youcef	ALG		0.73	25.11	1.08	
7	1	UJKASHEJ Drini	ALB			29.88	5.85	

Issued: 01/07/2022 at 10:16





# Swimming



## Results

RANK	HEAT	LANE	SURNAME & NAME	NOC	BORN	R.T.	TIME	GAP	FINA PTS
------	------	------	----------------	-----	------	------	------	-----	-------------

### Event 2

01/07/2022 - 10:10

## 50m Butterfly Men Preliminary

WR	22.27	GOVOROV ANDRY	UKR	2018
CR	23.50	IVAN LENDJER	SBR	2013

1	1	4	GKOLOMEEV Kristian	GRE		0.69	<b>23.70</b>		q
2	2	6	MOLLA YANES Mario	ESP		0.66	<b>23.81</b>	0.11	q
3	2	3	RIVOLTA Matteo	ITA		0.67	<b>23.89</b>	0.19	q
4	3	4	DE MATOS RIBEIRO Diogo	POR		0.64	<b>24.03</b>	0.33	q
5	1	5	BILAS Stergios Marios	GRE		0.73	<b>24.05</b>	0.35	q
6	1	6	SAKCI H.Emre	TUR		0.61	<b>24.08</b>	0.38	q
7	3	3	BEROL Julien Arthur	FRA			<b>24.09</b>	0.39	q
8	3	6	SYOUD Jaouad	ALG		0.71	<b>24.15</b>	0.45	q
9	2	4	DE ALMEIDA SILVA DUARTE	POR		0.68	<b>24.20</b>	0.50	R1
10	3	5	GURES Umit Can	TUR		0.66	<b>24.25</b>	0.55	R2
11	1	3	ANDOLFI Gianluca	ITA		0.63	<b>24.26</b>	0.56	
12	1	7	LOMERO ARENAS Tomas	AND		0.60	<b>24.47</b>	0.77	
13	2	5	COMTE Serguei Corentin	FRA		0.64	<b>24.57</b>	0.87	
14	3	2	MATIC Durde	SRB			<b>24.66</b>	0.96	
15	2	2	MARTINEZ NOVOA Miguel	ESP		0.62	<b>24.89</b>	1.19	
16	3	7	BOUZOUIA Youcef	ALG		0.73	<b>25.11</b>	1.41	
17	1	2	REBOSIO Alessandro	SMR		0.72	<b>26.26</b>	2.56	
18	2	7	TELAKU Alush	KOS		0.65	<b>26.74</b>	3.04	
19	3	1	UJKASHEJ Drini	ALB			<b>29.88</b>	6.18	

Issued: 01/07/2022 at 10:16



# Swimming



## Results

### Event 31

05/07/2022 - 18:00

### 100m Butterfly Men Final

WR	49.45	DRESSEL CALEB	USA	2021
CR	51.79	IVAN LENDJER	SRB	2009
JR	50.62	MILAK KRISTOF	HUN	2017

### Final

RANK	LANE	SURNAME & NAME	NOC	BORN	R.T.	50m	TIME	GAP	FINA PTS
1	3	RIVOLTA Matteo	ITA		0.65	24.32	<b>51.66</b> 27.34		CR
2	4	SYOUD Jaouad	ALG		0.65	24.57	<b>52.38</b> 27.81	0.72	
3	5	VALSECCHI Edoardo	ITA		0.64	24.50	<b>52.53</b> 28.03	0.87	
4	2	HUILLE Stanislas Franck	FRA		0.61	24.21	<b>52.66</b> 28.45	1.00	
5	8	MATIC Durde	SRB		0.63	24.68	<b>52.82</b> 28.14	1.16	
6	1	STAMOU Konstantinos	GRE		0.64	24.47	<b>52.92</b> 28.45	1.26	
7	7	VAZAIOS Andreas	GRE		0.63	25.07	<b>52.95</b> 27.88	1.29	
8	6	RIHOUX Charles	FRA		0.65	25.02	<b>53.50</b> 28.48	1.84	

Issued: 05/07/2022 at 18:02



# Swimming



## Results

### Event 31

05/07/2022 - 10:00

### 100m Butterfly Men Preliminary

WR	49.45	DRESSEL CALEB	USA	2021
CR	51.79	IVAN LENDJER	SRB	2009
JR	50.62	MILAK KRISTOF	HUN	2017

#### Heat 1 of 3

RANK	LANE	SURNAME & NAME	NOC	BORN	R.T.	50m	TIME	GAP	FINA PTS
1	4	RIVOLTA Matteo	ITA		0.66	25.02	<b>52.97</b> 27.95		q
2	5	HUILLE Stanislas Franck	FRA		0.63	24.81	<b>53.05</b> 28.24	0.08	q
3	3	MOLLA YANES Mario	ESP		0.66	24.93	<b>53.59</b> 28.66	0.62	
4	7	DE ALMEIDA SILVA Miguel	POR		0.62	24.94	<b>53.87</b> 28.93	0.90	
5	6	MARTINEZ NOVOA Miguel	ESP		0.62	25.55	<b>54.63</b> 29.08	1.66	
6	2	REBOSIO Alessandro	SMR		0.67	26.49	<b>57.08</b> 30.59	4.11	

Issued: 05/07/2022 at 10:01

#### Heat 2 of 3

1	4	SYOUD Jaouad	ALG		0.64	24.96	<b>52.52</b> 27.56		q
2	5	VALSECCHI Edoardo	ITA		0.65	24.47	<b>52.63</b> 28.16	0.11	q
3	6	VAZAIOS Andreas	GRE		0.63	25.41	<b>53.23</b> 27.82	0.71	q
4	3	STAMOU Konstantinos	GRE		0.65	24.80	<b>53.24</b> 28.44	0.72	q
5	7	LOMERO ARENAS Tomas	AND		0.61	25.59	<b>55.16</b> 29.57	2.64	
6	2	BENZIDOUN Fares	ALG		0.70	26.57	<b>57.90</b> 31.33	5.38	

Issued: 05/07/2022 at 10:05

#### Heat 3 of 3

1	3	RIHOUX Charles	FRA		0.68	24.72	<b>53.05</b> 28.33		q
2	6	MATIC Durde	SRB		0.61	25.35	<b>53.27</b> 27.92	0.22	q
3	5	DE MATOS RIBEIRO Diogo	POR		0.64	25.25	<b>53.50</b> 28.25	0.45	R1
4	4	GURES Umit Can	TUR		0.61	25.23	<b>53.53</b> 28.30	0.48	R2
5	2	TURNALI Polat Uzer	TUR		0.65	26.14	<b>56.01</b> 29.87	2.96	
6	7	MANOLI Christos	CYP		0.68	27.48	<b>58.14</b> 30.66	5.09	

RANK	LANE	SURNAME & NAME	NOC	BORN	R.T.	TIME	GAP	FINA	PTS
1		TELAKU Alush	KOS		0.61	27.59	59.70	32.11	6.65



Issued: 05/07/2022 at 10:09



# Swimming



## Results

RANK	HEAT	LANE	SURNAME & NAME	NOC	BORN	R.T.	50m	TIME	GAP	FINA PTS
------	------	------	----------------	-----	------	------	-----	------	-----	-------------

### Event 31

05/07/2022 - 10:00

## 100m Butterfly Men Preliminary

WR	49.45	DRESSEL CALEB	USA	2021
CR	51.79	IVAN LENDJER	SRB	2009
JR	50.62	MILAK KRISTOF	HUN	2017

1	2	4	SYOUD Jaouad	ALG		0.64	24.96	<b>52.52</b> 27.56		q
2	2	5	VALSECCHI Edoardo	ITA		0.65	24.47	<b>52.63</b> 28.16	0.11	q
3	1	4	RIVOLTA Matteo	ITA		0.66	25.02	<b>52.97</b> 27.95	0.45	q
4	1	5	HUILLE Stanislas Franck	FRA		0.63	24.81	<b>53.05</b> 28.24	0.53	q
4	3	3	RIHOUX Charles	FRA		0.68	24.72	<b>53.05</b> 28.33	0.53	q
6	2	6	VAZAIOS Andreas	GRE		0.63	25.41	<b>53.23</b> 27.82	0.71	q
7	2	3	STAMOU Konstantinos	GRE		0.65	24.80	<b>53.24</b> 28.44	0.72	q
8	3	6	MATIC Durde	SRB		0.61	25.35	<b>53.27</b> 27.92	0.75	q
9	3	5	DE MATOS RIBEIRO Diogo	POR		0.64	25.25	<b>53.50</b> 28.25	0.98	R1
10	3	4	GURES Umit Can	TUR		0.61	25.23	<b>53.53</b> 28.30	1.01	R2
11	1	3	MOLLA YANES Mario	ESP		0.66	24.93	<b>53.59</b> 28.66	1.07	
12	1	7	DE ALMEIDA SILVA Miguel	POR		0.62	24.94	<b>53.87</b> 28.93	1.35	
13	1	6	MARTINEZ NOVOA Miguel	ESP		0.62	25.55	<b>54.63</b> 29.08	2.11	
14	2	7	LOMERO ARENAS Tomas	AND		0.61	25.59	<b>55.16</b> 29.57	2.64	
15	3	2	TURNALI Polat Uzer	TUR		0.65	26.14	<b>56.01</b> 29.87	3.49	
16	1	2	REBOSIO Alessandro	SMR		0.67	26.49	<b>57.08</b> 30.59	4.56	
17	2	2	BENZIDOUN Fares	ALG		0.70	26.57	<b>57.90</b> 31.33	5.38	
18	3	7	MANOLI Christos	CYP		0.68	27.48	<b>58.14</b> 30.66	5.62	
19	3	1	TELAKU Alush	KOS		0.61	27.59	<b>59.70</b> 32.11	7.18	

Issued: 05/07/2022 at 10:09



# Swimming



## Results

RANK	LANE	SURNAME & NAME	NOC	BORN	R.T.	50m	100m	150m	TIME	GAP	FINA PTS
------	------	----------------	-----	------	------	-----	------	------	------	-----	-------------

### Event 28

04/07/2022 - 18:39

## 200m Butterfly Men Final

WR	1:50.73	MILAK KRISTOF	HUN	2022
CR	1:56.19	VELIMIR STJEPANOVIC	SRB	2013
JR	1:53.79	MILAK KRISTOF	HUN	2017

### Final

1	4	FARACI Claudio Antonino	ITA	0.66	26.03	55.15 29.12	1:25.45 30.30	<b>1:57.09</b> 31.64	
2	6	VAZAIOS Andreas	GRE	0.65	26.88	56.39 29.51	1:26.72 30.33	<b>1:57.92</b> 31.20	0.83
3	2	SYOUD Jaouad	ALG	0.66	25.79	55.36 29.57	1:25.89 30.53	<b>1:58.37</b> 32.48	1.28
4	7	MARSAU Matthias Ange	FRA	0.71	26.79	56.59 29.80	1:27.44 30.85	<b>1:59.14</b> 31.70	2.05
5	5	MARTINEZ NOVOA Miguel	ESP	0.63	26.99	57.55 30.56	1:28.03 30.48	<b>1:59.86</b> 31.83	2.77
6	3	TURNALI Polat Uzer	TUR	0.62	26.53	56.75 30.22	1:28.28 31.53	<b>2:00.54</b> 32.26	3.45
7	1	BRUNO Luca	ITA	0.67	26.47	56.60 30.13	1:28.06 31.46	<b>2:00.63</b> 32.57	3.54
8	8	REMY Tom Nicolas	FRA	0.65	26.59	57.03 30.44	1:29.16 32.13	<b>2:02.96</b> 33.80	5.87

Issued: 04/07/2022 at 18:54



# Swimming



## Results

Event 28  
04/07/2022 - 10:45

### 200m Butterfly Men Preliminary

RANK	LANE	SURNAME & NAME	NOC	BORN	R.T.	50m	100m	150m	TIME	GAP	FINA PTS
WR	1:50.73	MILAK KRISTOF	HUN								2022
CR	1:56.19	VELIMIR STJEPANOVIC	SRB								2013
JR	1:53.79	MILAK KRISTOF	HUN								2017

#### Heat 1 of 2

1	4	FARACI Claudio Antonino	ITA		0.71	26.36	55.90 29.54	1:26.46 30.56	<b>1:58.49</b> 32.03		q
2	7	VAZAIOS Andreas	GRE		0.66	27.35	58.05 30.70	1:28.53 30.48	<b>2:00.57</b> 32.04	2.08	q
3	5	MARSAU Matthias Ange	FRA		0.73	27.30	57.71 30.41	1:28.97 31.26	<b>2:00.76</b> 31.79	2.27	q
4	3	REMY Tom Nicolas	FRA		0.63	27.07	57.70 30.63	1:29.21 31.51	<b>2:01.71</b> 32.50	3.22	q
5	6	KHENDRICHE Lounis	ALG		0.78	27.28	58.09 30.81	1:31.10 33.01	<b>2:05.88</b> 34.78	7.39	R1
6	2	TELAKU Alush	KOS		0.60	28.39	1:01.33 32.94	1:36.84 35.51	<b>2:13.84</b> 37.00	15.35	

Issued: 04/07/2022 at 10:41

#### Heat 2 of 2

1	5	MARTINEZ NOVOA Miguel	ESP		0.63	26.97	57.82 30.85	1:28.41 30.59	<b>1:59.93</b> 31.52		q
2	6	TURNALI Polat Uzer	TUR		0.63	27.02	57.40 30.38	1:28.76 31.36	<b>2:00.12</b> 31.36	0.19	q
3	4	SYOUD Jaouad	ALG		0.65	26.79	56.98 30.19	1:28.32 31.34	<b>2:00.73</b> 32.41	0.80	q
4	3	BRUNO Luca	ITA		0.79	27.16	57.35 30.19	1:28.76 31.41	<b>2:00.92</b> 32.16	0.99	q
5	2	REBOSIO Alessandro	SMR		0.69	28.07	1:00.38 32.31	1:32.74 32.36	<b>2:06.26</b> 33.52	6.33	R2
6	1	MANOLI Christos	CYP		0.66	28.75	1:01.39 32.64	1:34.42 33.03	<b>2:09.20</b> 34.78	9.27	
7	7	AL SHARIF Siraj	LBA		0.65	29.88	1:04.84 34.96	1:43.02 38.18	<b>2:22.97</b> 39.95	23.04	

Issued: 04/07/2022 at 10:47



# Swimming



## Results

RANK HEAT LANE SURNAME & NAME NOC BORN R.T. 50m 100m 150m TIME GAP FINA PTS

### Event 28

04/07/2022 - 10:45

### 200m Butterfly Men Preliminary

WR	1:50.73	MILAK KRISTOF	HUN	2022
CR	1:56.19	VELIMIR STJEPANOVIC	SRB	2013
JR	1:53.79	MILAK KRISTOF	HUN	2017

1	1	4	<b>FARACI Claudio Antonino</b>	ITA	0.71	26.36	55.90 29.54	1:26.46 30.56	<b>1:58.49</b> 32.03		q
2	2	5	<b>MARTINEZ NOVOA Miguel</b>	ESP	0.63	26.97	57.82 30.85	1:28.41 30.59	<b>1:59.93</b> 31.52	1.44	q
3	2	6	<b>TURNALI Polat Uzer</b>	TUR	0.63	27.02	57.40 30.38	1:28.76 31.36	<b>2:00.12</b> 31.36	1.63	q
4	1	7	<b>VAZAIOS Andreas</b>	GRE	0.66	27.35	58.05 30.70	1:28.53 30.48	<b>2:00.57</b> 32.04	2.08	q
5	2	4	<b>SYOUD Jaouad</b>	ALG	0.65	26.79	56.98 30.19	1:28.32 31.34	<b>2:00.73</b> 32.41	2.24	q
6	1	5	<b>MARSAU Matthias Ange</b>	FRA	0.73	27.30	57.71 30.41	1:28.97 31.26	<b>2:00.76</b> 31.79	2.27	q
7	2	3	<b>BRUNO Luca</b>	ITA	0.79	27.16	57.35 30.19	1:28.76 31.41	<b>2:00.92</b> 32.16	2.43	q
8	1	3	<b>REMY Tom Nicolas</b>	FRA	0.63	27.07	57.70 30.63	1:29.21 31.51	<b>2:01.71</b> 32.50	3.22	q
9	1	6	<b>KHENDRICHE Lounis</b>	ALG	0.78	27.28	58.09 30.81	1:31.10 33.01	<b>2:05.88</b> 34.78	7.39	R1
10	2	2	<b>REBOSIO Alessandro</b>	SMR	0.69	28.07	1:00.38 32.31	1:32.74 32.36	<b>2:06.26</b> 33.52	7.77	R2
11	2	1	<b>MANOLI Christos</b>	CYP	0.66	28.75	1:01.39 32.64	1:34.42 33.03	<b>2:09.20</b> 34.78	10.71	
12	1	2	<b>TELAKU Alush</b>	KOS	0.60	28.39	1:01.33 32.94	1:36.84 35.51	<b>2:13.84</b> 37.00	15.35	
13	2	7	<b>AL SHARIF Siraj</b>	LBA	0.65	29.88	1:04.84 34.96	1:43.02 38.18	<b>2:22.97</b> 39.95	24.48	

NOT CLASSIFIED

A 7 **PAPASTAMOS Apostolos** GRE **DNS-M**

Issued: 04/07/2022 at 10:47





# Swimming



## Results

RANK	LANE	SURNAME & NAME	NOC	BORN	R.T.	50m	100m	150m	TIME	GAP	FINA PTS
------	------	----------------	-----	------	------	-----	------	------	------	-----	-------------

### Event 21

03/07/2022 - 18:43

## 200m Individual Medley Men Final

WR	1:54.00	LOCHTE RYAN	USA	2011
CR	1:58.38	OUSSAMA MELLOULI	TUN	2009
WJ	1:56.99	KOS HUBERT	HUN	2021

### Final

1	4	SYOUD Jaouad	ALG	0.65	25.43	55.79 30.36	1:29.25 33.46	<b>1:58.83</b> 29.58	
1	3	VAZAIOS Andreas	GRE	0.62	25.82	55.34 29.52	1:29.82 34.48	<b>1:58.83</b> 29.01	
3	7	MATTEAZZI Pier Andrea	ITA	0.72	26.87	56.73 29.86	1:31.44 34.71	<b>2:00.24</b> 28.80	1.41
4	5	ALMEIDA LOPES Gabriel	POR	0.60	25.73	56.40 30.67	1:30.42 34.02	<b>2:00.28</b> 29.86	1.45
5	6	BIDARD Clement	FRA	0.69	26.75	58.41 31.66	1:32.55 34.14	<b>2:01.78</b> 29.23	2.95
6	2	SAKA Berke	TUR	0.68	26.17	56.88 30.71	1:32.35 35.47	<b>2:02.12</b> 29.77	3.29
7	1	SORRISO Giovanni	ITA	0.65	27.18	58.77 31.59	1:33.46 34.69	<b>2:03.33</b> 29.87	4.50
8	8	SURKOVIC Mario	CRO	0.71	26.66	58.38 31.72	1:34.28 35.90	<b>2:04.10</b> 29.82	5.27

Issued: 03/07/2022 at 19:01

# Swimming



## Results

Event 21  
03/07/2022 - 11:29

### 200m Individual Medley Men Preliminary

WR	1:54.00	LOCHTE RYAN	USA	2011
CR	1:58.38	OUSSAMA MELLOULI	TUN	2009
WJ	1:56.99	KOS HUBERT	HUN	2021

#### Heat 1 of 2

RANK	LANE	SURNAME & NAME	NOC	BORN	R.T.	50m	100m	150m	TIME	GAP	FINA PTS
1	4	VAZAIOS Andreas	GRE		0.63	26.41	57.07 30.66	1:32.11 35.04	<b>2:01.97</b> 29.86		q
2	3	MATTEAZZI Pier Andrea	ITA		0.65	27.04	57.72 30.68	1:32.69 34.97	<b>2:02.80</b> 30.11	0.83	q
3	6	SURKOVIC Mario	CRO		0.71	26.24	57.54 31.30	1:34.60 37.06	<b>2:04.38</b> 29.78	2.41	q
4	7	CASTEJON I RAMIREZ Alex	ESP		0.64	27.39	59.50 32.11	1:35.15 35.65	<b>2:04.71</b> 29.56	2.74	R2
5	2	REMY Tom Nicolas Pierre-	FRA		0.64	26.72	59.63 32.91	1:35.59 35.96	<b>2:05.88</b> 30.29	3.91	
6	1	CHOUCHAR Ramzi	ALG		0.62	26.97	1:00.45 33.48	1:36.04 35.59	<b>2:07.10</b> 31.06	5.13	

NOT CLASSIFIED

5		MANACAS SILVA SANTOS AI.	POR						<b>DNS-M</b>		
---	--	--------------------------	-----	--	--	--	--	--	--------------	--	--

Issued: 03/07/2022 at 11:09

#### Heat 2 of 2

1	4	SYOUD Jaouad	ALG		0.63	25.74	56.30 30.56	1:30.06 33.76	<b>2:00.41</b> 30.35		q
2	5	ALMEIDA LOPES Gabriel	POR		0.63	25.62	55.72 30.10	1:30.74 35.02	<b>2:00.86</b> 30.12	0.45	q
3	6	BIDARD Clement	FRA		0.71	26.48	57.83 31.35	1:32.64 34.81	<b>2:02.56</b> 29.92	2.15	q
4	3	SAKA Berke	TUR		0.69	26.46	57.51 31.05	1:33.28 35.77	<b>2:02.77</b> 29.49	2.36	q
5	7	SORRISO Giovanni	ITA		0.67	27.52	58.68 31.16	1:33.44 34.76	<b>2:03.46</b> 30.02	3.05	q
6	2	FERS ERZEN Anze	SLO		0.67	26.74	57.80 31.06	1:33.94 36.14	<b>2:04.54</b> 30.60	4.13	R1
7	8	GIOURTZIDIS Daniil	GRE		0.76	27.28	59.53 32.25	1:34.94 35.41	<b>2:05.33</b> 30.39	4.92	
8	1	KORKMAZ Kaan	TUR		0.69	27.35	1:00.41 33.06	1:37.98 37.57	<b>2:08.56</b> 30.58	8.15	

Issued: 03/07/2022 at 11:15

# Swimming



## Results

RANK HEAT LANE SURNAME & NAME NOC BORN R.T. 50m 100m 150m TIME GAP FINA PTS

### Event 21

03/07/2022 - 11:29

### 200m Individual Medley Men Preliminary

WR	1:54.00	LOCHTE RYAN	USA	2011
CR	1:58.38	OUSSAMA MELLOULI	TUN	2009
WJ	1:56.99	KOS HUBERT	HUN	2021

RANK	HEAT	LANE	SURNAME & NAME	NOC	BORN	R.T.	50m	100m	150m	TIME	GAP	FINA PTS
1	2	4	SYOUD Jaouad	ALG		0.63	25.74	56.30 30.56	1:30.06 33.76	<b>2:00.41</b> 30.35		q
2	2	5	ALMEIDA LOPES Gabriel	POR		0.63	25.62	55.72 30.10	1:30.74 35.02	<b>2:00.86</b> 30.12	0.45	q
3	1	4	VAZAIOS Andreas	GRE		0.63	26.41	57.07 30.66	1:32.11 35.04	<b>2:01.97</b> 29.86	1.56	q
4	2	6	BIDARD Clement	FRA		0.71	26.48	57.83 31.35	1:32.64 34.81	<b>2:02.56</b> 29.92	2.15	q
5	2	3	SAKA Berke	TUR		0.69	26.46	57.51 31.05	1:33.28 35.77	<b>2:02.77</b> 29.49	2.36	q
6	1	3	MATTEAZZI Pier Andrea	ITA		0.65	27.04	57.72 30.68	1:32.69 34.97	<b>2:02.80</b> 30.11	2.39	q
7	2	7	SORRISO Giovanni	ITA		0.67	27.52	58.68 31.16	1:33.44 34.76	<b>2:03.46</b> 30.02	3.05	q
8	1	6	SURKOVIC Mario	CRO		0.71	26.24	57.54 31.30	1:34.60 37.06	<b>2:04.38</b> 29.78	3.97	q
9	2	2	FERS ERZEN Anze	SLO		0.67	26.74	57.80 31.06	1:33.94 36.14	<b>2:04.54</b> 30.60	4.13	R1
10	1	7	CASTEJON I RAMIREZ Alex	ESP		0.64	27.39	59.50 32.11	1:35.15 35.65	<b>2:04.71</b> 29.56	4.30	R2
11	2	8	GIOURTZIDIS Daniil	GRE		0.76	27.28	59.53 32.25	1:34.94 35.41	<b>2:05.33</b> 30.39	4.92	
12	1	2	REMY Tom Nicolas Pierre-	FRA		0.64	26.72	59.63 32.91	1:35.59 35.96	<b>2:05.88</b> 30.29	5.47	
13	1	1	CHOUCHAR Ramzi	ALG		0.62	26.97	1:00.45 33.48	1:36.04 35.59	<b>2:07.10</b> 31.06	6.69	
14	2	1	KORKMAZ Kaan	TUR		0.69	27.35	1:00.41 33.06	1:37.98 37.57	<b>2:08.56</b> 30.58	8.15	

NOT CLASSIFIED

1	5		MANACAS SILVA SANTOS AI.	POR								DNS-M
---	---	--	--------------------------	-----	--	--	--	--	--	--	--	-------

Issued: 03/07/2022 at 11:15



# Swimming



## Results

RANK	LANE	SURNAME & NAME			NOC	BORN			R.T.	TIME	GAP	FINA
	50m	100m	150m	200m	250m	300m	350m				PTS	

Event 14

02/07/2022 - 18:59

### 400m Individual Medley Men Final

WR	4:03.84	PHELPS MICHAEL			USA			2008
CR	4:10.53	OUSSAMA MELLOULI			TUN			2009
WJ	4:10.02	BORODIN ILYA			RUS			2021

### Final

1	3	<b>MATTEAZZI Pier Andrea</b>			ITA			0.68	<b>4:13.83</b>	
		27.24(3)	58.28(1)	1:31.10(1)	2:03.27(1)	2:39.31(1)	3:15.30(1)	3:45.08(1)		
			31.04	32.82	32.17	36.04	35.99	29.78	28.75	
2	4	<b>FERS ERZEN Anze</b>			SLO			0.65	<b>4:19.63</b>	5.80
		27.10(2)	58.52(4)	1:32.05(2)	2:04.45(2)	2:41.53(2)	3:18.82(2)	3:49.72(2)		
			31.42	33.53	32.40	37.08	37.29	30.90	29.91	
3	5	<b>SARPE Pietro Paolo</b>			ITA			0.62	<b>4:20.41</b>	6.58
		27.38(4)	58.44(3)	1:32.18(3)	2:04.84(3)	2:42.45(3)	3:20.60(3)	3:50.95(3)		
			31.06	33.74	32.66	37.61	38.15	30.35	29.46	
4	6	<b>REMY Tom Nicolas Pierre-</b>			FRA			0.66	<b>4:21.42</b>	7.59
		26.99(1)	58.32(2)	1:33.08(4)	2:07.05(4)	2:43.81(4)	3:21.14(5)	3:52.46(5)		
			31.33	34.76	33.97	36.76	37.33	31.32	28.96	
5	2	<b>CASTEJON I RAMIREZ Alex</b>			ESP			0.65	<b>4:22.39</b>	8.56
		27.79(7)	59.63(5)	1:33.98(5)	2:07.75(5)	2:44.17(5)	3:20.98(4)	3:52.45(4)		
			31.84	34.35	33.77	36.42	36.81	31.47	29.94	
6	1	<b>LE PAPE Thomas Yoann</b>			FRA			0.63	<b>4:26.34</b>	12.51
		27.48(5)	59.98(7)	1:35.21(6)	2:09.60(6)	2:47.64(6)	3:25.87(7)	3:57.73(7)		
			32.50	35.23	34.39	38.04	38.23	31.86	28.61	
7	7	<b>CHOUCHAR Ramzi</b>			ALG			0.63	<b>4:27.93</b>	14.10
		27.61(6)	59.64(6)	1:35.39(7)	2:10.50(7)	2:47.66(7)	3:24.99(6)	3:57.03(6)		
			32.03	35.75	35.11	37.16	37.33	32.04	30.90	
8	8	<b>KORKMAZ Kaan</b>			TUR			0.65	<b>4:29.09</b>	15.26
		27.79(7)	1:00.22(8)	1:35.86(8)	2:10.79(8)	2:48.56(8)	3:26.59(8)	3:58.57(8)		
			32.43	35.64	34.93	37.77	38.03	31.98	30.52	

Issued: 02/07/2022 at 19:12

# Swimming



## Results

RANK	LANE	SURNAME & NAME			NOC	BORN			R.T.	TIME	GAP	FINA	PTS
	50m	100m	150m	200m	250m	300m	350m						

### Event 14

02/07/2022 - 10:59

## 400m Individual Medley Men Preliminary

WR	4:03.84	PHELPS MICHAEL			USA			2008
CR	4:10.53	OUSSAMA MELLOULI			TUN			2009
WJ	4:10.02	BORODIN ILYA			RUS			2021

### Heat 1 of 2

1	2	<b>FERS ERZEN Anze</b>	SLO					<b>4:23.00</b>		q
		27.13(1) 58.54(1) 31.41	1:31.91(1) 33.37	2:03.89(1) 31.98	2:41.17(1) 37.28	3:19.05(1) 37.88	3:52.01(1) 32.96	30.99		
2	3	<b>SARPE Pietro Paolo</b>	ITA					<b>4:23.36</b>	0.36	q
		27.87(2) 59.43(2) 31.56	1:32.75(2) 33.32	2:05.60(2) 32.85	2:43.83(2) 38.23	3:22.04(2) 38.21	3:52.94(2) 30.90	30.42		
3	4	<b>CASTEJON I RAMIREZ Alex</b>	ESP					<b>4:25.74</b>	2.74	q
		28.41(5) 1:00.88(5) 32.47	1:35.91(5) 35.03	2:09.94(4) 34.03	2:47.35(4) 37.41	3:24.22(3) 36.87	3:55.54(3) 31.32	30.20		
4	6	<b>CHOUCHAR Ramzi</b>	ALG					<b>4:27.52</b>	4.52	q
		27.87(2) 59.86(3) 31.99	1:35.46(4) 35.60	2:10.00(5) 34.54	2:47.23(3) 37.23	3:24.71(4) 37.48	3:56.71(4) 32.00	30.81		
5	5	<b>GIOURTZIDIS Daniil</b>	GRE					<b>4:29.58</b>	6.58	R2
		28.19(4) 1:00.64(4) 32.45	1:35.29(3) 34.65	2:09.83(3) 34.54	2:47.62(5) 37.79	3:25.60(5) 37.98	3:57.76(5) 32.16	31.82		

Issued: 02/07/2022 at 11:02

### Heat 2 of 2

1	4	<b>MATTEAZZI Pier Andrea</b>	ITA					<b>4:23.56</b>		q
		27.52(3) 58.77(3) 31.25	1:32.43(1) 33.66	2:05.47(1) 33.04	2:42.65(1) 37.18	3:20.47(1) 37.82	3:52.55(1) 32.08	31.01		
2	3	<b>REMY Tom Nicolas Pierre-</b>	FRA					<b>4:24.40</b>	0.84	q
		27.30(1) 58.39(2) 31.09	1:32.91(2) 34.52	2:06.86(2) 33.95	2:44.32(2) 37.46	3:21.69(2) 37.37	3:53.56(2) 31.87	30.84		
3	2	<b>LE PAPE Thomas Yoann</b>	FRA					<b>4:27.93</b>	4.37	q
		28.37(5) 1:01.22(5) 32.85	1:36.84(5) 35.62	2:11.50(4) 34.66	2:49.79(5) 38.29	3:27.86(4) 38.07	3:59.39(4) 31.53	28.54		
4	6	<b>KORKMAZ Kaan</b>	TUR					<b>4:29.23</b>	5.67	q
		28.02(4) 1:00.61(4) 32.59	1:36.68(4) 36.07	2:12.54(5) 35.86	2:49.67(4) 37.13	3:27.41(3) 37.74	3:58.75(3) 31.34	30.48		
5	7	<b>TURNALI Polat Uzer</b>	TUR					<b>4:29.29</b>	5.73	R1
		27.31(2) 58.07(1) 30.76	1:33.82(3) 35.75	2:08.22(3) 34.40	2:48.98(3) 40.76	3:29.52(5) 40.54	3:59.96(5) 30.44	29.33		

Issued: 02/07/2022 at 11:09

# Swimming



## Results

RANK	HEAT	LANE	SURNAME & NAME	NOC	BORN	R.T.	TIME	GAP	FINA	
			50m	100m	150m	200m	250m	300m	350m	PTS

### Event 14

02/07/2022 - 10:59

## 400m Individual Medley Men Preliminary

WR	4:03.84	PHELPS MICHAEL	USA	2008
CR	4:10.53	OUSSAMA MELLOULI	TUN	2009
WJ	4:10.02	BORODIN ILYA	RUS	2021

1	1	2	<b>FERS ERZEN Anze</b>	SLO					<b>4:23.00</b>		<b>q</b>	
			27.13	58.54	1:31.91	2:03.89	2:41.17	3:19.05	3:52.01			
				31.41	33.37	31.98	37.28	37.88	32.96	30.99		
2	1	3	<b>SARPE Pietro Paolo</b>	ITA						<b>4:23.36</b>	0.36	<b>q</b>
			27.87	59.43	1:32.75	2:05.60	2:43.83	3:22.04	3:52.94			
				31.56	33.32	32.85	38.23	38.21	30.90	30.42		
3	2	4	<b>MATTEAZZI Pier Andrea</b>	ITA						<b>4:23.56</b>	0.56	<b>q</b>
			27.52	58.77	1:32.43	2:05.47	2:42.65	3:20.47	3:52.55			
				31.25	33.66	33.04	37.18	37.82	32.08	31.01		
4	2	3	<b>REMY Tom Nicolas Pierre-</b>	FRA						<b>4:24.40</b>	1.40	<b>q</b>
			27.30	58.39	1:32.91	2:06.86	2:44.32	3:21.69	3:53.56			
				31.09	34.52	33.95	37.46	37.37	31.87	30.84		
5	1	4	<b>CASTEJON I RAMIREZ Alex</b>	ESP						<b>4:25.74</b>	2.74	<b>q</b>
			28.41	1:00.88	1:35.91	2:09.94	2:47.35	3:24.22	3:55.54			
				32.47	35.03	34.03	37.41	36.87	31.32	30.20		
6	1	6	<b>CHOUCHAR Ramzi</b>	ALG						<b>4:27.52</b>	4.52	<b>q</b>
			27.87	59.86	1:35.46	2:10.00	2:47.23	3:24.71	3:56.71			
				31.99	35.60	34.54	37.23	37.48	32.00	30.81		
7	2	2	<b>LE PAPE Thomas Yoann</b>	FRA						<b>4:27.93</b>	4.93	<b>q</b>
			28.37	1:01.22	1:36.84	2:11.50	2:49.79	3:27.86	3:59.39			
				32.85	35.62	34.66	38.29	38.07	31.53	28.54		
8	2	6	<b>KORKMAZ Kaan</b>	TUR						<b>4:29.23</b>	6.23	<b>q</b>
			28.02	1:00.61	1:36.68	2:12.54	2:49.67	3:27.41	3:58.75			
				32.69	36.07	35.86	37.13	37.74	31.34	30.48		
9	2	7	<b>TURNALI Polat Uzer</b>	TUR						<b>4:29.29</b>	6.29	<b>R1</b>
			27.31	58.07	1:33.82	2:08.22	2:48.98	3:29.52	3:59.96			
				30.76	35.75	34.40	40.76	40.54	30.44	29.33		
10	1	5	<b>GIOURTZIDIS Daniil</b>	GRE						<b>4:29.58</b>	6.58	<b>R2</b>
			28.19	1:00.64	1:35.29	2:09.83	2:47.62	3:25.60	3:57.76			
				32.45	34.65	34.54	37.79	37.98	32.16	31.82		

NOT CLASSIFIED

A	5	<b>SYOUD Jaouad</b>	ALG	DNS-M
---	---	---------------------	-----	-------

Issued: 02/07/2022 at 11:09

# Swimming

## Results



RANK	LANE	NOC	RELAY	SURNAME & NAME	BORN	R.T.	50m	TIME	GAP	FINA	PTS
------	------	-----	-------	----------------	------	------	-----	------	-----	------	-----

**Event 23**  
03/07/2022 - 19:44

### 4 x 100m Freestyle Men

WR	3:08.24	USA	USA	2008
CR	3:12.03	FRANCE	FRA	2009
JR	3:15.80	USA	USA	2019

### FINAL

1	4	<b>ITA ITALY</b>						<b>3:15.77</b>		
		SERIO Luca	0.64	23.49	49.79	23.49				
		BORI Alessandro	0.33	23.62	48.85	1:13.41				
		CARRARO Giovanni	0.24	22.97	48.68	2:01.61				
		MEGLI Filippo	0.25	23.38	48.45	2:50.70				
2	5	<b>GRE GREECE</b>						<b>3:16.64</b>	0.87	
		VAZAIOS Andreas	0.62	24.42	49.46	24.42				
		BILAS Stergios Marios	0.27	22.92	49.01	1:12.38				
		GKOLOMEEV Kristian	0.22	22.73	48.24	2:01.20				
		MARKOS Dimitrios	0.34	24.25	49.93	2:50.96				
3	1	<b>FRA FRANCE</b>						<b>3:18.04</b>	2.27	
		RIHOUX Charles	0.63	22.84	49.00	22.84				
		EVEN Mathias	0.33	23.03	49.19	1:12.03				
		HUG-DREYFUS Tom Paul	0.26	23.71	50.22	2:01.90				
		BEROL Julien Arthur	0.16	23.49	49.63	2:51.90				
4	3	<b>TUR TURKIYE</b>						<b>3:19.35</b>	3.58	
		GURDENLI Emre	0.61	24.15	49.90	24.15				
		CELIK Doga	0.33	23.61	50.58	1:13.51				
		UNLU Baturalp	0.11	23.24	49.23	2:03.72				
		SAKCI H.Emre	0.22	23.52	49.64	2:53.23				
5	8	<b>ESP SPAIN</b>						<b>3:20.10</b>	4.33	
		DOMINGUEZ CALONGE Luis	0.74	23.70	49.73	23.70				
		MOLLA YANES Mario	0.36	23.71	49.63	1:13.44				
		SEGURA GUTIERREZ Juan	0.13	23.53	49.88	2:02.89				
		MARTINEZ NOVOA Miguel	0.35	24.35	50.86	2:53.59				
6	2	<b>POR PORTUGAL</b>						<b>3:20.66</b>	4.89	
		DE ALMEIDA SILVA Miguel	0.64	23.46	49.88	23.46				
		DE MATOS RIBEIRO Diogo	0.25	22.81	48.22	1:12.69				
		SANTOS Francisco	0.42	24.08	50.74	2:02.18				
		NOGUEIRA DA COSTA Joao	0.30	24.16	51.82	2:53.00				
7	7	<b>CYP CYPRUS</b>						<b>3:32.33</b>	16.56	
		PANTZIAROS Andreas	0.68	25.88	54.05	25.88				
		MANOLI Christos	0.36	25.13	52.55	1:19.18				
		IAKOVIDIS Filippou	0.41	25.11	53.20	2:11.71				
		IAKOVIDIS Markos	0.40	24.87	52.53	3:04.67				

NOT CLASSIFIED

6		<b>ALG ALGERIA</b>						<b>DSQ</b>		
		BELKHELLADI Malachy	0.66	24.81	52.05	24.81				
		BENZIDOUN Fares	- 0.15							
		BENBARA Mehdi-Nazim								
		BOUZOUIA Youcef								

Issued: 03/07/2022 at 20:16



# Swimming



## Results

RANK	LANE	NOC	RELAY	SURNAME & NAME	BORN	R.T.	50m	100m	200m	300m	TIME	GAP	FINA	PTS
------	------	-----	-------	----------------	------	------	-----	------	------	------	------	-----	------	-----

Event 8  
01/07/2022 - 19:17

### 4 x 200m Freestyle Men

WR	6:58.55	USA												2009
CR	7:09.44	ITALIE												2009

### FINAL

1	3	GRE	GREECE								<b>7:17.91</b>			
			MARKOS Dimitrios			0.72	25.51	53.02	1:20.23	1:47.72	1:47.72			
			MAKRYGIANNIS Evangelos			0.24	25.45	53.21	1:22.53	1:52.22	3:39.94			
			STAMOU Konstantinos Emma			0.25	24.68	52.68	1:21.22	1:50.03	5:29.97			
			VAZAIOS Andreas			0.35	24.63	51.74	1:19.09	1:47.94	7:17.91			
2	2	ESP	SPAIN								<b>7:23.07</b>	5.16		
			MOLLA YANES Mario			0.68	25.70	53.68	1:22.75	1:52.59	1:52.59			
			QUIJADA ROLDAN Carlos			0.14	25.12	52.79	1:21.22	1:50.23	3:42.82			
			DOMINGUEZ CALONGE Luis			0.21	24.43	51.75	1:20.49	1:49.03	5:31.85			
			MARTINEZ NOVOA Miguel			0.15	25.08	53.37	1:22.17	1:51.22	7:23.07			
3	5	TUR	TURKIYE								<b>7:23.67</b>	5.76		
			UNLU Baturalp			0.72	25.66	53.19	1:21.80	1:49.63	1:49.63			
			FILIZ Batuhan			0.10	25.03	53.60	1:22.05	1:49.92	3:39.55			
			TURAN Efe			0.45	25.29	53.35	1:22.46	1:51.33	5:30.88			
			CELIK Doga			0.37	24.92	53.14	1:23.11	1:52.79	7:23.67			
4	6	ALG	ALGERIA								<b>7:40.10</b>	22.19		
			DJABALLAH Mohamed Anisse			0.75	26.23	53.97	1:23.18	1:53.00	1:53.00			
			ACHOUR TALET Sofiane Ben			0.48	25.97	54.14	1:24.03	1:55.26	3:48.26			
			KHENDRICHE Lounis			0.36	25.84	54.60	1:24.97	1:56.06	5:44.32			
			BENZIDOUN Fares			0.21	25.48	54.02	1:24.61	1:55.78	7:40.10			

NOT CLASSIFIED

4		ITA	ITALY								<b>DSQ</b>			
			ZUIN Mattia			0.66	25.21	52.88	1:21.18	1:49.49	1:49.49			
			DE TULLIO Luca			0.15	24.98	52.61	1:20.60	1:49.51	3:39.00			
			MEGLI Filippo			- 0.27								
			PROIETTI COLONNA Alessio											

Issued: 01/07/2022 at 20:08





# Swimming



## Results

RANK LANE NOC RELAY R.T. 50m TIME GAP FINA PTS  
SURNAME & NAME BORN

### Event 30

04/07/2022 - 19:10

### 4 x 100m Medley Men Final

WR	3:26.78	USA	USA	2021
CR	3:34.22	SPAIN	ESP	2009
JR	3:33.19	RUS	RUS	2019

### Final

RANK	LANE	NOC	RELAY	R.T.	50m	TIME	GAP	FINA PTS
1	6	ITA	<b>ITALY</b>			<b>3:35.77</b>		
			MORA Lorenzo	0.60	26.34	54.73	26.34	
			PINZUTI Alessandro	0.24	28.02	1:00.44	1:22.75	
			RIVOLTA Matteo	0.19	23.92	51.56	2:19.09	
			BORI Alessandro	0.39	23.94	49.04	3:10.67	
2	5	FRA	<b>FRANCE</b>			<b>3:36.03</b>	0.26	
			CHOUCHAOU Mathys	0.60	27.10	54.87	27.10	
			BIDARD Clement	0.11	28.22	1:00.46	1:23.09	
			HUILLE Stanislas Franck	0.31	24.23	52.43	2:19.56	
			RIHOUX Charles	0.12	22.89	48.27	3:10.65	
3	4	TUR	<b>TURKIYE</b>			<b>3:36.29</b>	0.52	
			SAKA Berke	0.65	26.33	54.88	26.33	
			OGRETIR Berkay O.	0.28	27.95	59.28	1:22.83	
			GURES Umit Can	0.21	24.34	52.18	2:18.50	
			UNLU Baturalp	0.29	23.36	49.95	3:09.70	
4	7	GRE	<b>GREECE</b>			<b>3:36.34</b>	0.57	
			MAKRYGIANNIS Evangelos	0.62	26.12	54.87	26.12	
			MERETSOLIAS Konstantinos	0.41	27.85	1:00.88	1:22.72	
			STAMOU Konstantinos	0.27	24.09	52.61	2:19.84	
			GKOLOMEEV Kristian	0.34	23.04	47.98	3:11.40	
5	1	POR	<b>PORTUGAL</b>			<b>3:37.50</b>	1.73	
			NOGUEIRA DA COSTA Joao	0.63	26.37	54.45	26.37	
			ALMEIDA LOPES Gabriel	0.31	28.56	1:01.45	1:23.01	
			DE MATOS RIBEIRO Diogo	0.27	23.94	52.80	2:19.84	
			DE ALMEIDA SILVA Miguel	0.16	23.00	48.80	3:11.70	
6	3	ESP	<b>SPAIN</b>			<b>3:39.50</b>	3.73	
			MARTOS BACARIZO Manuel	0.49	26.45	55.17	26.45	
			CASTEJON I RAMIREZ Alex	0.19	28.63	1:02.23	1:23.80	
			MOLLA YANES Mario	0.33	23.90	53.01	2:21.30	
			DOMINGUEZ CALONGE Luis	0.23	23.14	49.09	3:13.55	
7	2	SLO	<b>SLOVENIA</b>			<b>3:41.38</b>	5.61	
			BOSKAN Saso	0.56	26.88	55.57	26.88	
			STEVENS Peter John	0.10	27.59	1:01.20	1:23.16	
			FERS ERZEN Anze	0.22	24.99	54.40	2:21.76	
			SENICA PAVLETIC Primoz	0.05	23.69	50.21	3:14.86	
8	8	ALG	<b>ALGERIA</b>			<b>3:46.25</b>	10.48	
			ARDJOUNE Abdellah	0.59	26.63	56.16	26.63	
			BALAMANE Moncef Aymen	0.06	28.33	1:02.10	1:24.49	
			BENZIDOUN Fares	0.12	25.90	56.76	2:24.16	
			BENBARA Mehdi-Nazim	0.30	24.22	51.23	3:19.24	

Issued: 04/07/2022 at 19:27



# Swimming



## Results

RANK	LANE	NOC	RELAY	SURNAME & NAME	BORN	R.T.	50m	TIME	GAP	FINA	PTS
<b>Event 30</b>											
<b>04/07/2022 - 10:55</b>											
<b>4 x 100m Medley Men Preliminary</b>											

WR	3:26.78	USA	USA	2021
JR	3:33.19	RUS	RUS	2019

### Heat 1 of 2

1	4	<b>TUR TURKIYE</b>						<b>3:41.15</b>		q
		SAKA Berke	0.58	27.20	56.46			27.20		
		OGRETIR Berkay O.	0.36	28.13	1:00.17			1:24.59		
		GURES Umit Can	0.24	25.62	54.33			2:22.25		
		UNLU Baturalp	0.16	23.93	50.19			3:14.89		
2	6	<b>ESP SPAIN</b>						<b>3:41.85</b>	0.70	q
		MARTOS BACARIZO Manuel	0.50	26.15	54.69			26.15		
		CASTEJON I RAMIREZ Alex	0.22	29.08	1:02.28			1:23.77		
		MOLLA YANES Mario	0.24	25.60	55.20			2:22.57		
		DOMINGUEZ CALONGE Luis	0.17	23.25	49.68			3:15.42		
3	3	<b>SLO SLOVENIA</b>						<b>3:43.51</b>	2.36	q
		BOSKAN Saso	0.59	26.89	55.90			26.89		
		STEVENS Peter John	0.19	27.54	1:02.07			1:23.44		
		FERS ERZEN Anze	0.13	24.90	54.45			2:22.87		
		SENICA PAVLETIC Primoz	9.00	24.20	51.09			3:16.62		
4	5	<b>ALG ALGERIA</b>						<b>3:48.37</b>	7.22	q
		ARDJOUNE Abdellah	0.59	27.67	57.30			27.67		
		BALAMANE Moncef Aymen	0.01	28.75	1:02.57			1:26.05		
		BENZIDOUN Fares	0.45	26.37	57.19			2:26.24		
		BENBARA Mehdi-Nazim	0.44	24.52	51.31			3:21.58		

Issued: 04/07/2022 at 10:57

### Heat 2 of 2

1	6	<b>FRA FRANCE</b>						<b>3:41.50</b>		q
		BRUN Christophe Pierre	0.63	27.38	56.23			27.38		
		BIDARD Clement	0.10	28.54	1:00.95			1:24.77		
		COMTE Serguei Coentin	0.41	25.13	54.46			2:22.31		
		RIHOUX Charles	0.17	22.91	49.86			3:14.55		
2	4	<b>ITA ITALY</b>						<b>3:43.34</b>	1.84	q
		RESTIVO Matteo	0.59	27.31	56.44			27.31		
		FUSCO Alessandro	0.34	29.30	1:01.90			1:25.74		
		STEFANTH Simone	0.44	24.34	53.01			2:22.68		
		MEGLI Filippo	0.25	24.76	51.99			3:16.11		
3	5	<b>GRE GREECE</b>						<b>3:44.94</b>	3.44	q
		SPANOUKAKIS Georgios	0.62	27.46	55.69			27.46		
		MERETSOLIAS Konstantinos	0.37	29.15	1:03.78			1:24.84		
		STAMOU Konstantinos	0.40	25.30	54.21			2:24.77		
		BILAS Stergios Marios	0.55	24.21	51.26			3:17.89		
4	2	<b>POR PORTUGAL</b>						<b>3:47.43</b>	5.93	q
		SANTOS Francisco	0.65	26.78	55.53			26.78		
		DE OLIVEIRA Francisco	0.17	28.63	1:01.96			1:24.16		
		DE MATOS RIBEIRO Diogo	0.41	25.14	55.00			2:22.63		
		DE ALMEIDA SILVA Miguel	0.33	26.13	54.94			3:18.62		
5	3	<b>CYP CYPRUS</b>						<b>3:59.81</b>	18.31	R1
		MOUGIS Sofoklis	0.59	27.91	58.54			27.91		
		PANARETOS Panayiotis	0.23	29.35	1:03.36			1:27.89		
		MANOLI Christos	0.47	27.75	59.64			2:29.65		
		IAKOVIDIS Markos	0.72	27.97	58.27			3:29.51		

Issued: 04/07/2022 at 11:04



# Swimming



## Results

RANK LANE SURNAME & NAME NOC BORN R.T. TIME GAP FINA PTS

### Event 1

01/07/2022 - 18:00

### 50m Freestyle Women Final

WR	23.67	SJOESTROEM Sarah	SWE	2017
CR	24.83	OSMAN FARIDA	EGY	2018

### Final

1	4	MUNOZ DEL CAMPO Lidon	ESP	0.68	<b>24.97</b>	
2	3	KLANCAR Neza	SLO	0.76	<b>25.01</b>	0.04
3	5	ANTONIOU Kalia	CYP	0.70	<b>25.06</b>	0.09
4	2	SANTAMANS Anna Flora	FRA	0.63	<b>25.37</b>	0.40
5	6	SCOTTO DI CARLO Viola	ITA	0.67	<b>25.48</b>	0.51
6	7	HADJILOIZOU Anna	CYP	0.66	<b>25.55</b>	0.58
7	1	STANISAVLJEVIC Nina	SRB	0.74	<b>25.77</b>	0.80
8	8	KLIKOPOULOU Sofia	GRE	0.70	<b>25.93</b>	0.96

Issued: 01/07/2022 at 19:06



# Swimming

## Results

RANK	LANE	SURNAME & NAME	NOC	BORN	R.T.	TIME	GAP	FINA PTS
------	------	----------------	-----	------	------	------	-----	-------------

### Event 1

01/07/2022 - 10:00

## 50m Freestyle Women Preliminary

WR	23.67	SJOESTROEM Sarah	SWE	2017
CR	24.83	OSMAN FARIDA	EGY	2018

### Heat 1 of 3

1	4	KLANCAR Neza	SLO	0.75	<b>25.25</b>		q
2	6	KLIKOPOULOU Sofia	GRE	0.68	<b>25.77</b>	0.52	q
3	5	MELIH Amel	ALG	0.72	<b>25.85</b>	0.60	R1
4	3	DRASIDOU Maria Thaleia	GRE	0.73	<b>26.06</b>	0.81	
5	2	PINTAR Tjasa	SLO	0.69	<b>26.32</b>	1.07	
6	7	FREITAS GUEDES Ana Marga	POR	0.63	<b>26.55</b>	1.30	

NOT CLASSIFIED

1		POPOVIC Tanja	SRB				DNS
---	--	---------------	-----	--	--	--	-----

Issued: 01/07/2022 at 10:12

### Heat 2 of 3

1	4	ANTONIOU Kalia	CYP		<b>25.24</b>		q
2	3	SCOTTO DI CARLO Viola	ITA		<b>25.32</b>	0.08	q
3	5	SANTAMANS Anna Flora	FRA		<b>25.54</b>	0.30	q
4	6	HADJILIOZOU Anna	CYP		<b>25.63</b>	0.39	q
5	7	MEDJAHED Nesrine	ALG		<b>26.15</b>	0.91	
6	2	CAKICI I.Nihan	TUR		<b>26.57</b>	1.33	
7	1	TUDO CUBELLS Nadia	AND		<b>27.99</b>	2.75	

Issued: 01/07/2022 at 10:12

### Heat 3 of 3

1	4	MUNOZ DEL CAMPO Lidon	ESP		<b>25.19</b>		q
2	5	STANISAVLJEVIC Nina	SRB		<b>25.67</b>	0.48	q
3	2	TESSARIOL Lucile Lora	FRA		<b>26.01</b>	0.82	R2
4	3	WEILER SASTRE Carmen	ESP		<b>26.02</b>	0.83	
5	6	LUTECKA Claudia	ITA		<b>26.05</b>	0.86	
6	7	ELIGUL Sezin	TUR		<b>26.91</b>	1.72	
7	1	SOARES MARTINS Francisca	POR		<b>27.06</b>	1.87	
8	8	RAMIREZ ABELLA Monica	AND		<b>27.34</b>	2.15	

Issued: 01/07/2022 at 10:12



# Swimming



## Results

RANK HEAT LANE SURNAME & NAME NOC BORN R.T. TIME GAP FINA PTS

### Event 1

01/07/2022 - 10:00

### 50m Freestyle Women Preliminary

WR	23.67	SJOESTROEM Sarah	SWE	2017
CR	24.83	OSMAN FARIDA	EGY	2018

1	3	4	MUNOZ DEL CAMPO Lidon	ESP		25.19		q
2	2	4	ANTONIOU Kalia	CYP		25.24	0.05	q
3	1	4	KLANCAR Neza	SLO	0.75	25.25	0.06	q
4	2	3	SCOTTO DI CARLO Viola	ITA		25.32	0.13	q
5	2	5	SANTAMANS Anna Flora	FRA		25.54	0.35	q
6	2	6	HADJILOIZOU Anna	CYP		25.63	0.44	q
7	3	5	STANISAVLJEVIC Nina	SRB		25.67	0.48	q
8	1	6	KLIKOPOULOU Sofia	GRE	0.68	25.77	0.58	q
9	1	5	MELIH Amel	ALG	0.72	25.85	0.66	R1
10	3	2	TESSARIOL Lucile Lora	FRA		26.01	0.82	R2
11	3	3	WEILER SASTRE Carmen	ESP		26.02	0.83	
12	3	6	LUTECKA Claudia	ITA		26.05	0.86	
13	1	3	DRASIDOU Maria Thaleia	GRE	0.73	26.06	0.87	
14	2	7	MEDJAHED Nesrine	ALG		26.15	0.96	
15	1	2	PINTAR Tjasa	SLO	0.69	26.32	1.13	
16	1	7	FREITAS GUEDES Ana Marga	POR	0.63	26.55	1.36	
17	2	2	CAKICI I.Nihan	TUR		26.57	1.38	
18	3	7	ELIGUL Sezin	TUR		26.91	1.72	
19	3	1	SOARES MARTINS Francisca	POR		27.06	1.87	
20	3	8	RAMIREZ ABELLA Monica	AND		27.34	2.15	
21	2	1	TUDO CUBELLS Nadia	AND		27.99	2.80	

NOT CLASSIFIED

1 1 POPOVIC Tanja SRB DNS

Issued: 01/07/2022 at 10:17



# Swimming



## Results

RANK	LANE	SURNAME & NAME	NOC	BORN	R.T.	50m	TIME	GAP	FINA PTS
------	------	----------------	-----	------	------	-----	------	-----	-------------

Event 20  
03/07/2022 - 18:31

### 100m Freestyle Women Final

WR	51.71	SJOESTROEM Sarah	SWE	2017
CR	54.72	MALIA METELLA	FRA	2009
WJ	52.70	OLEKSIK PENELOPE	CAN	2016

### Final

1	4	ANTONIOU Kalia	CYP	0.71	26.66	<b>54.36</b> 27.70		CR
2	5	SEGEL Janja	SLO	0.75	26.40	<b>54.48</b> 28.08	0.12	
3	3	KLANCAR Neza	SLO	0.74	27.14	<b>55.31</b> 28.17	0.95	
4	1	MUNOZ DEL CAMPO Lidon	ESP	0.66	26.45	<b>55.35</b> 28.90	0.99	
5	6	TESSARIOL Lucile Lora	FRA	0.71	27.03	<b>55.49</b> 28.46	1.13	
6	7	MORINI Sofia	ITA	0.73	26.85	<b>55.56</b> 28.71	1.20	
7	2	JEHL Marina	FRA	0.62	26.93	<b>55.85</b> 28.92	1.49	
8	8	STANISAVLJEVIC Nina	SRB	0.66	27.21	<b>56.39</b> 29.18	2.03	

Issued: 03/07/2022 at 18:45

# Swimming



## Results

Event 20  
03/07/2022 - 11:14

### 100m Freestyle Women Preliminary

WR	51.71	SJOESTROEM Sarah	SWE	2017
CR	54.72	MALIA METELLA	FRA	2009
WJ	52.70	OLEKSIAK PENELOPE	CAN	2016

#### Heat 1 of 3

RANK	LANE	SURNAME & NAME	NOC	BORN	R.T.	50m	TIME	GAP	FINA PTS
1	4	KLANCAR Neza	SLO		0.75	26.70	<b>55.70</b> 29.00		q
2	3	JEHL Marina	FRA		0.60	27.09	<b>55.89</b> 28.80	0.19	q
3	5	STANISAVLJEVIC Nina	SRB		0.64	27.26	<b>56.26</b> 29.00	0.56	q
4	2	SOARES MARTINS Francisca	POR		0.64	27.92	<b>57.48</b> 29.56	1.78	
5	6	CAKICI I.Nihan	TUR		0.75	27.64	<b>57.66</b> 30.02	1.96	
6	7	DE PINHO RODRIGUES Ana	POR		0.68	28.22	<b>59.10</b> 30.88	3.40	

Issued: 03/07/2022 at 10:54

#### Heat 2 of 3

1	4	SEGEL Janja	SLO		0.71	26.79	<b>55.30</b> 28.51		q
2	3	MIZZAU Alice	ITA		0.71	27.30	<b>56.30</b> 29.00	1.00	R1
3	2	HADJILOIZOU Anna	CYP		0.66	27.11	<b>56.57</b> 29.46	1.27	R2
4	5	WEILER SASTRE Carmen	ESP		0.71	27.33	<b>57.02</b> 29.69	1.72	
5	7	MITSAKOU Chrysoula	GRE		0.68	28.08	<b>58.28</b> 30.20	2.98	
6	1	TUDO CUBELLS Nadia	AND		0.68	28.55	<b>1:00.02</b> 31.47	4.72	

NOT CLASSIFIED

6		AVRAMOVA Ekaterina I.	TUR				<b>DNS</b>		
---	--	-----------------------	-----	--	--	--	------------	--	--

Issued: 03/07/2022 at 10:58

#### Heat 3 of 3

1	4	ANTONIOU Kalia	CYP		0.71	27.19	<b>55.11</b> 27.92		q
2	3	TESSARIOL Lucile Lora	FRA		0.69	27.05	<b>55.75</b> 28.70	0.64	q
3	6	MORINI Sofia	ITA		0.71	26.71	<b>55.90</b> 29.19	0.79	q
4	5	MUNOZ DEL CAMPO Lidon	ESP		0.65	27.23	<b>56.22</b> 28.99	1.11	q
5	7	KLIKOPOULOU Sofia	GRE		0.65	27.55	<b>57.03</b> 29.48	1.92	

RANK	LANE	SURNAME & NAME	NOC	BORN	R.T.	TIME	GAP	FINA PTS
6	1	MEDJAHED Nesrine	ALG		0.68	27.81	<b>58.00</b>	2.89
							30.19	
NOT CLASSIFIED								
	2	MELIH Amel	ALG				<b>DNS</b>	

Issued: 03/07/2022 at 11:02



# Swimming



## Results

RANK HEAT LANE SURNAME & NAME NOC BORN R.T. 50m TIME GAP FINA PTS

### Event 20

03/07/2022 - 11:14

## 100m Freestyle Women Preliminary

WR	51.71	SJOESTROEM Sarah	SWE	2017
CR	54.72	MALIA METELLA	FRA	2009
WJ	52.70	OLEKSIK PENELOPE	CAN	2016

RANK	HEAT	LANE	SURNAME & NAME	NOC	BORN	R.T.	50m	TIME	GAP	FINA PTS
1	3	4	ANTONIOU Kalia	CYP		0.71	27.19	<b>55.11</b> 27.92		q
2	2	4	SEGEL Janja	SLO		0.71	26.79	<b>55.30</b> 28.51	0.19	q
3	1	4	KLANCAR Neza	SLO		0.75	26.70	<b>55.70</b> 29.00	0.59	q
4	3	3	TESSARIOL Lucile Lora	FRA		0.69	27.05	<b>55.75</b> 28.70	0.64	q
5	1	3	JEHL Marina	FRA		0.60	27.09	<b>55.89</b> 28.80	0.78	q
6	3	6	MORINI Sofia	ITA		0.71	26.71	<b>55.90</b> 29.19	0.79	q
7	3	5	MUNOZ DEL CAMPO Lidon	ESP		0.65	27.23	<b>56.22</b> 28.99	1.11	q
8	1	5	STANISAVLJEVIC Nina	SRB		0.64	27.26	<b>56.26</b> 29.00	1.15	q
9	2	3	MIZZAU Alice	ITA		0.71	27.30	<b>56.30</b> 29.00	1.19	R1
10	2	2	HADJILIOZOU Anna	CYP		0.66	27.11	<b>56.57</b> 29.46	1.46	R2
11	2	5	WEILER SASTRE Carmen	ESP		0.71	27.33	<b>57.02</b> 29.69	1.91	
12	3	7	KLIKOPOULOU Sofia	GRE		0.65	27.55	<b>57.03</b> 29.48	1.92	
13	1	2	SOARES MARTINS Francisca	POR		0.64	27.92	<b>57.48</b> 29.56	2.37	
14	1	6	CAKICI I.Nihan	TUR		0.75	27.64	<b>57.66</b> 30.02	2.55	
15	3	1	MEDJAHED Nesrine	ALG		0.68	27.81	<b>58.00</b> 30.19	2.89	
16	2	7	MITSAKOU Chrysoula	GRE		0.68	28.08	<b>58.28</b> 30.20	3.17	
17	1	7	DE PINHO RODRIGUES Ana	POR		0.68	28.22	<b>59.10</b> 30.88	3.99	
18	2	1	TUDO CUBELLS Nadia	AND		0.68	28.55	<b>1:00.02</b> 31.47	4.91	

NOT CLASSIFIED

2	6	AVRAMOVA Ekaterina I.	TUR					DNS		
3	2	MELIH Amel	ALG					DNS		

Issued: 03/07/2022 at 11:16



# Swimming



## Results

RANK LANE SURNAME & NAME NOC BORN R.T. 50m 100m 150m TIME GAP FINA PTS

Event 11  
02/07/2022 - 18:18

### 200m Freestyle Women Final

WR	1:52.98	PELLEGRINI Federica	ITA	2009
CR	1:56.68	SEGEL Janja	SLO	02/07/2022
WJ	1:55.11	O'CALLAGHAN MOLLIE	CAN	2022

#### Final

RANK	LANE	SURNAME & NAME	NOC	BORN	R.T.	50m	100m	150m	TIME	GAP	FINA PTS
1	4	SEGEL Janja	SLO	0.74	27.63	57.04 29.41	1:27.07 30.03	<b>1:56.68</b> 29.61			CR
2	5	FAIN Katja	SLO	0.72	28.17	57.70 29.53	1:27.54 29.84	<b>1:57.49</b> 29.95	0.81		
3	6	MIZZAU Alice	ITA	0.73	28.27	58.23 29.96	1:29.16 30.93	<b>1:59.95</b> 30.79	3.27		
4	3	TESSARIOL Lucile Lora	FRA	0.69	28.51	58.93 30.42	1:29.79 30.86	<b>2:00.40</b> 30.61	3.72		
5	2	CARNEZ Oceane Delphine	FRA	0.64	28.75	59.55 30.80	1:30.19 30.64	<b>2:01.12</b> 30.93	4.44		
6	7	CESARANO Noemi	ITA	0.72	28.80	58.92 30.12	1:30.15 31.23	<b>2:01.21</b> 31.06	4.53		
7	8	SOARES MARTINS Francisca	POR	0.67	28.41	58.69 30.28	1:30.38 31.69	<b>2:02.02</b> 31.64	5.34		
8	1	CAMPABADAL AMEZCUA Ainho	ESP	0.74	28.48	59.45 30.97	1:30.52 31.07	<b>2:02.20</b> 31.68	5.52		

Issued: 02/07/2022 at 18:26



# Swimming



## Results

Event 11  
02/07/2022 - 10:20

### 200m Freestyle Women Preliminary

WR	1:52.98	PELLEGRINI Federica	ITA	2009
CR	1:58.91	PATRICIA CASTRO ORTEGA	ESP	2009
WJ	1:55.11	O'CALLAGHAN MOLLIE	CAN	2022

#### Heat 1 of 3

RANK	LANE	SURNAME & NAME	NOC	BORN	R.T.	50m	100m	150m	TIME	GAP	FINA PTS
1	4	MIZZAU Alice	ITA	0.73	28.69	58.94 30.25	1:30.02 31.08	<b>2:01.04</b> 31.02			q
2	3	CAMPABADAL AMEZCUA Ainho	ESP	0.74	29.41	1:00.47 31.06	1:31.41 30.94	<b>2:02.20</b> 30.79	1.16		q
3	5	BOCEKLER Beril	TUR	0.71	29.84	1:00.99 31.15	1:33.05 32.06	<b>2:04.53</b> 31.48	3.49		
4	6	MITSAKOU Xanthi	GRE	0.69	29.59	1:01.24 31.65	1:33.83 32.59	<b>2:06.42</b> 32.59	5.38		
5	2	MIDOUNI Lilia Sihem	ALG	0.73	30.00	1:02.97 32.97	1:36.81 33.84	<b>2:11.14</b> 34.33	10.10		

Issued: 02/07/2022 at 10:23

#### Heat 2 of 3

1	4	SEGEL Janja	SLO	0.72	28.06	58.38 30.32	1:29.59 31.21	<b>2:00.04</b> 30.45			q
2	3	TESSARIOL Lucile Lora	FRA	0.70	28.44	59.16 30.72	1:29.87 30.71	<b>2:00.42</b> 30.55	0.38		q
3	6	SOARES MARTINS Francisca	POR	0.66	29.38	1:00.47 31.09	1:31.87 31.40	<b>2:02.38</b> 30.51	2.34		q
4	5	TUNCEL Merve	TUR	0.72	29.54	1:00.64 31.10	1:31.89 31.25	<b>2:02.47</b> 30.58	2.43		R2
5	2	MITSAKOU Chrysoula	GRE	0.68	28.98	59.86 30.88	1:30.54 30.68	<b>2:02.91</b> 32.37	2.87		
6	7	DANDE Sara	ALB	0.74	31.93	1:06.64 34.71	1:43.13 36.49	<b>2:19.31</b> 36.18	19.27		

Issued: 02/07/2022 at 10:29

#### Heat 3 of 3

1	4	FAIN Katja	SLO	0.75	28.57	59.46 30.89	1:30.38 30.92	<b>2:00.17</b> 29.79			q
2	5	CARNEZ Oceane Delphine	FRA	0.69	29.03	59.50 30.47	1:31.10 31.60	<b>2:01.11</b> 30.01	0.94		q
3	3	CESARANO Noemi	ITA	0.72	28.94	59.46 30.52	1:30.67 31.21	<b>2:01.54</b> 30.87	1.37		q
4	2	HOLUB Tamila Hryhorivna	POR	0.76	29.13	1:00.05 30.92	1:31.29 31.24	<b>2:02.45</b> 31.16	2.28		R1
5	6	JUSTE SANCHEZ Paula	ESP	0.65	29.38	1:00.12 30.74	1:31.59 31.47	<b>2:03.51</b> 31.92	3.34		

Issued: 02/07/2022 at 10:33



# Swimming



## Results

RANK HEAT LANE SURNAME & NAME NOC BORN R.T. 50m 100m 150m TIME GAP FINA PTS

Event 11  
02/07/2022 - 10:20

### 200m Freestyle Women Preliminary

WR	1:52.98	PELLEGRINI Federica	ITA	2009
CR	1:58.91	PATRICIA CASTRO ORTEGA	ESP	2009
WJ	1:55.11	O'CALLAGHAN MOLLIE	CAN	2022

1	2	4	SEGEL Janja	SLO	0.72	28.06	58.38 30.32	1:29.59 31.21	<b>2:00.04</b> 30.45		q
2	3	4	FAIN Katja	SLO	0.75	28.57	59.46 30.89	1:30.38 30.92	<b>2:00.17</b> 29.79	0.13	q
3	2	3	TESSARIOL Lucile Lora	FRA	0.70	28.44	59.16 30.72	1:29.87 30.71	<b>2:00.42</b> 30.55	0.38	q
4	1	4	MIZZAU Alice	ITA	0.73	28.69	58.94 30.25	1:30.02 31.08	<b>2:01.04</b> 31.02	1.00	q
5	3	5	CARNEZ Oceane Delphine	FRA	0.69	29.03	59.50 30.47	1:31.10 31.60	<b>2:01.11</b> 30.01	1.07	q
6	3	3	CESARANO Noemi	ITA	0.72	28.94	59.46 30.52	1:30.67 31.21	<b>2:01.54</b> 30.87	1.50	q
7	1	3	CAMPABADAL AMEZCUA Ainho	ESP	0.74	29.41	1:00.47 31.06	1:31.41 30.94	<b>2:02.20</b> 30.79	2.16	q
8	2	6	SOARES MARTINS Francisca	POR	0.66	29.38	1:00.47 31.09	1:31.87 31.40	<b>2:02.38</b> 30.51	2.34	q
9	3	2	HOLUB Tamila Hryhorivna	POR	0.76	29.13	1:00.05 30.92	1:31.29 31.24	<b>2:02.45</b> 31.16	2.41	R1
10	2	5	TUNCEL Merve	TUR	0.72	29.54	1:00.64 31.10	1:31.89 31.25	<b>2:02.47</b> 30.58	2.43	R2
11	2	2	MITSAKOU Chrysoula	GRE	0.68	28.98	59.86 30.88	1:30.54 30.68	<b>2:02.91</b> 32.37	2.87	
12	3	6	JUSTE SANCHEZ Paula	ESP	0.65	29.38	1:00.12 30.74	1:31.59 31.47	<b>2:03.51</b> 31.92	3.47	
13	1	5	BOCEKLER Beril	TUR	0.71	29.84	1:00.99 31.15	1:33.05 32.06	<b>2:04.53</b> 31.48	4.49	
14	1	6	MITSAKOU Xanthi	GRE	0.69	29.59	1:01.24 31.65	1:33.83 32.59	<b>2:06.42</b> 32.59	6.38	
15	1	2	MIDOUNI Lilia Sihem	ALG	0.73	30.00	1:02.97 32.97	1:36.81 33.84	<b>2:11.14</b> 34.33	11.10	
16	2	7	DANDE Sara	ALB	0.74	31.93	1:06.64 34.71	1:43.13 36.49	<b>2:19.31</b> 36.18	19.27	

Issued: 02/07/2022 at 10:33

# Swimming



## Results

RANK	LANE	SURNAME & NAME			NOC	BORN			R.T.	TIME	GAP	FINA PTS
		50m	100m	150m		200m	250m	300m				

Event 32

05/07/2022 - 18:04

### 400m Freestyle Women Final

WR	3:56.40	TITMUS Ariarne	AUS	2022
CR	4:00.41	FEDERICA PELLEGRINI	ITA	2009
JR	3:58.37	LEDECKY KATHLEEN	USA	2014

### Final

Rank	Lane	Name	NOC	50m	100m	150m	200m	250m	300m	350m	R.T.	TIME	GAP	PTS
1	4	<b>ERTAN Deniz</b>	TUR	28.78(1)	59.90(1) 31.12	1:31.36(1) 31.46	2:02.85(1) 31.49	2:34.20(1) 31.35	3:05.89(1) 31.69	3:37.59(1) 31.70	0.71	<b>4:08.04</b>		
2	6	<b>FAIN Katja</b>	SLO	29.20(3)	1:00.19(2) 30.99	1:31.60(2) 31.41	2:03.49(2) 31.89	2:34.92(2) 31.43	3:06.74(2) 31.82	3:38.25(2) 31.51	0.74	<b>4:09.07</b>	1.03	
3	3	<b>CESARANO Antonietta</b>	ITA	29.41(4)	1:00.50(4) 31.09	1:32.07(3) 31.57	2:04.04(3) 31.97	2:35.77(3) 31.73	3:07.52(3) 31.75	3:39.05(3) 31.53	0.74	<b>4:10.13</b>	2.09	
4	5	<b>CARAMIGNOLI Martina Rita</b>	ITA	29.75(5)	1:01.05(5) 31.30	1:32.86(5) 31.81	2:04.92(4) 32.06	2:36.79(4) 31.87	3:08.65(4) 31.86	3:40.73(4) 32.08	0.78	<b>4:12.08</b>	4.04	
5	7	<b>HOLUB Tamila Hryhorivna</b>	POR	29.76(6)	1:01.39(6) 31.63	1:33.12(6) 31.73	2:05.00(5) 31.88	2:36.92(5) 31.92	3:09.18(5) 32.26	3:41.93(5) 32.75	0.77	<b>4:14.25</b>	6.21	
6	2	<b>BOCEKLER Beril</b>	TUR	29.04(2)	1:00.26(3) 31.22	1:32.37(4) 32.11	2:05.20(6) 32.83	2:38.57(6) 33.37	3:12.13(6) 33.56	3:45.02(6) 32.89	0.70	<b>4:17.92</b>	9.88	
7	8	<b>JUSTE SANCHEZ Paula</b>	ESP	29.93(7)	1:01.62(7) 31.69	1:34.23(8) 32.61	2:06.89(7) 32.66	2:40.04(7) 33.15	3:13.42(7) 33.38	3:47.00(7) 33.58	0.79	<b>4:20.10</b>	12.06	
8	1	<b>SOARES MARTINS Francisca</b>	POR	30.05(8)	1:01.76(8) 31.71	1:33.95(7) 32.19	2:07.20(8) 33.25	2:41.00(8) 33.80	3:15.28(8) 34.28	3:50.00(8) 34.72	0.65	<b>4:24.14</b>	16.10	

Issued: 05/07/2022 at 18:12



## Results

RANK	LANE	SURNAME & NAME			NOC	BORN			R.T.	TIME	GAP	FINA	PTS
	50m	100m	150m	200m	250m	300m	350m						

Event 32  
05/07/2022 - 10:10

### 400m Freestyle Women Preliminary

WR	3:56.40	TITMUS Ariarne	AUS	2022
CR	4:00.41	FEDERICA PELLEGRINI	ITA	2009
JR	3:58.37	LEDECKY KATHLEEN	USA	2014

#### Heat 1 of 2

1	5	<b>FAIN Katja</b>	SLO	0.75	<b>4:15.08</b>		q					
		29.57(1)	1:02.08(2)	1:34.74(3)	2:07.44(3)	2:39.61(3)	3:11.97(2)	3:44.01(2)				
			32.51	32.66	32.70	32.17	32.36	32.04	31.07			
2	4	<b>BOCEKLER Beril</b>	TUR	0.70	<b>4:15.84</b>	0.76	q					
		29.90(2)	1:01.98(1)	1:34.05(1)	2:06.25(1)	2:38.53(1)	3:11.20(1)	3:44.00(1)				
			32.08	32.07	32.20	32.28	32.67	32.80	31.84			
3	3	<b>HOLUB Tamila Hryhorivna</b>	POR	0.76	<b>4:16.57</b>	1.49	q					
		30.30(4)	1:02.55(3)	1:34.54(2)	2:07.13(2)	2:39.45(2)	3:12.20(3)	3:44.75(3)				
			32.25	31.99	32.59	32.32	32.75	32.55	31.82			
4	7	<b>MITSAKOU Chrysoula</b>	GRE	0.70	<b>4:22.11</b>	7.03	R1					
		30.68(5)	1:03.61(5)	1:36.81(5)	2:10.05(5)	2:43.05(5)	3:16.24(4)	3:49.74(4)				
			32.93	33.20	33.24	33.00	33.19	33.50	32.37			
5	2	<b>TUSEK Dasa</b>	SLO	0.71	<b>4:22.60</b>	7.52	R2					
		30.29(3)	1:02.85(4)	1:35.48(4)	2:09.01(4)	2:42.22(4)	3:16.52(5)	3:50.12(5)				
			32.56	32.63	33.53	33.21	34.30	33.60	32.48			
6	1	<b>MIDOUNI Lilia Sihem</b>	ALG	0.73	<b>4:43.40</b>	28.32						
		32.05(6)	1:07.26(6)	1:43.23(6)	2:19.40(6)	2:55.98(6)	3:32.74(6)	4:09.01(6)				
			35.21	35.97	36.17	36.58	36.76	36.27	34.39			

NOT CLASSIFIED

6	<b>CAMPABADAL Ainhoa</b>	ESP										DNS
---	--------------------------	-----	--	--	--	--	--	--	--	--	--	-----

Issued: 05/07/2022 at 10:16

#### Heat 2 of 2

1	4	<b>ERTAN Deniz</b>	TUR	0.69	<b>4:11.39</b>		q					
		29.02(1)	1:00.48(1)	1:32.13(1)	2:04.10(1)	2:36.00(1)	3:07.97(1)	3:39.93(1)				
			31.46	31.65	31.97	31.90	31.97	31.96	31.46			
2	3	<b>CARAMIGNOLI Martina Rita</b>	ITA	0.74	<b>4:14.50</b>	3.11	q					
		30.30(6)	1:02.70(4)	1:34.88(3)	2:07.09(3)	2:38.82(3)	3:10.70(3)	3:42.76(2)				
			32.40	32.18	32.21	31.73	31.88	32.06	31.74			
3	5	<b>CESARANO Antonietta</b>	ITA	0.75	<b>4:14.82</b>	3.43	q					
		29.89(2)	1:01.42(2)	1:33.65(2)	2:05.93(2)	2:38.37(2)	3:10.58(2)	3:43.04(3)				
			31.53	32.23	32.28	32.44	32.21	32.46	31.78			
4	2	<b>SOARES MARTINS Francisca</b>	POR	0.66	<b>4:21.04</b>	9.65	q					
		29.96(3)	1:02.63(3)	1:35.21(4)	2:08.29(4)	2:41.51(4)	3:15.32(4)	3:49.37(5)				
			32.67	32.58	33.08	33.22	33.81	34.05	31.67			
5	6	<b>JUSTE SANCHEZ Paula</b>	ESP	0.66	<b>4:21.09</b>	9.70	q					
		30.23(5)	1:02.86(5)	1:35.97(5)	2:09.13(5)	2:42.15(5)	3:15.42(5)	3:48.89(4)				
			32.63	33.11	33.16	33.02	33.27	33.47	32.20			
6	7	<b>TISSANDIE Camille Amelie</b>	FRA	0.72	<b>4:25.20</b>	13.81						
		30.45(7)	1:03.34(7)	1:36.77(6)	2:10.49(6)	2:44.23(6)	3:18.26(6)	3:52.50(6)				
			32.89	33.43	33.72	33.74	34.03	34.24	32.70			
7	1	<b>MITSAKOU Xanthi</b>	GRE	0.68	<b>4:31.62</b>	20.23						
		29.96(3)	1:03.23(6)	1:36.88(7)	2:11.38(7)	2:45.99(7)	3:21.42(7)	3:56.65(7)				
			33.27	33.65	34.50	34.61	35.43	35.23	34.97			
8	8	<b>DANDE Sara</b>	ALB	0.74	<b>4:47.68</b>	36.29						
		32.16(8)	1:07.10(8)	1:43.93(8)	2:20.72(8)	2:57.84(8)	3:34.94(8)	4:12.19(8)				
			34.94	36.83	36.79	37.12	37.10	37.25	35.49			

Issued: 05/07/2022 at 10:24



## Results

RANK	HEAT	LANE	SURNAME & NAME	NOC	BORN	R.T.	TIME	GAP	FINA	PTS
			50m	100m	150m	200m	250m	300m	350m	

Event 32  
05/07/2022 - 10:10

### 400m Freestyle Women Preliminary

WR	3:56.40	TITMUS Ariarne	AUS	2022
CR	4:00.41	FEDERICA PELLEGRINI	ITA	2009
JR	3:58.37	LEDECKY KATHLEEN	USA	2014

1	2	4	<b>ERTAN Deniz</b>	TUR		0.69	<b>4:11.39</b>			q	
			29.02	1:00.48	1:32.13	2:04.10	2:36.00	3:07.97	3:39.93		
				31.46	31.65	31.97	31.90	31.97	31.96		
2	2	3	<b>CARAMIGNOLI Martina Rita</b>	ITA		0.74	<b>4:14.50</b>	3.11		q	
			30.30	1:02.70	1:34.88	2:07.09	2:38.82	3:10.70	3:42.76		
				32.40	32.18	32.21	31.73	31.88	32.06		
3	2	5	<b>CESARANO Antonietta</b>	ITA		0.75	<b>4:14.82</b>	3.43		q	
			29.89	1:01.42	1:33.65	2:05.93	2:38.37	3:10.58	3:43.04		
				31.53	32.23	32.28	32.44	32.21	32.46		
4	1	5	<b>FAIN Katja</b>	SLO		0.75	<b>4:15.08</b>	3.69		q	
			29.57	1:02.08	1:34.74	2:07.44	2:39.61	3:11.97	3:44.01		
				32.51	32.66	32.70	32.17	32.36	32.04		
5	1	4	<b>BOCEKLER Beril</b>	TUR		0.70	<b>4:15.84</b>	4.45		q	
			29.90	1:01.98	1:34.05	2:06.25	2:38.53	3:11.20	3:44.00		
				32.08	32.07	32.20	32.28	32.67	32.80		
6	1	3	<b>HOLUB Tamila Hryhorivna</b>	POR		0.76	<b>4:16.57</b>	5.18		q	
			30.30	1:02.55	1:34.54	2:07.13	2:39.45	3:12.20	3:44.75		
				32.25	31.99	32.59	32.32	32.75	32.55		
7	2	2	<b>SOARES MARTINS Francisca</b>	POR		0.66	<b>4:21.04</b>	9.65		q	
			29.96	1:02.63	1:35.21	2:08.29	2:41.51	3:15.32	3:49.37		
				32.67	32.58	33.08	33.22	33.81	34.05		
8	2	6	<b>JUSTE SANCHEZ Paula</b>	ESP		0.66	<b>4:21.09</b>	9.70		q	
			30.23	1:02.86	1:35.97	2:09.13	2:42.15	3:15.42	3:48.89		
				32.63	33.11	33.16	33.02	33.27	33.47		
9	1	7	<b>MITSAKOU Chrysoula</b>	GRE		0.70	<b>4:22.11</b>	10.72		R1	
			30.68	1:03.61	1:36.81	2:10.05	2:43.05	3:16.24	3:49.74		
				32.93	33.20	33.24	33.00	33.19	33.50		
10	1	2	<b>TUSEK Dasa</b>	SLO		0.71	<b>4:22.60</b>	11.21		R2	
			30.29	1:02.85	1:35.48	2:09.01	2:42.22	3:16.52	3:50.12		
				32.56	32.63	33.53	33.21	34.30	33.60		
11	2	7	<b>TISSANDIE Camille Amelie</b>	FRA		0.72	<b>4:25.20</b>	13.81			
			30.45	1:03.34	1:36.77	2:10.49	2:44.23	3:18.26	3:52.50		
				32.89	33.43	33.72	33.74	34.03	34.24		
12	2	1	<b>MITSAKOU Xanthi</b>	GRE		0.68	<b>4:31.62</b>	20.23			
			29.96	1:03.23	1:36.88	2:11.38	2:45.99	3:21.42	3:56.65		
				33.27	33.65	34.50	34.61	35.43	35.23		
13	1	1	<b>MIDOUNI Lilia Sihem</b>	ALG		0.73	<b>4:43.40</b>	32.01			
			32.05	1:07.26	1:43.23	2:19.40	2:55.98	3:32.74	4:09.01		
				35.21	35.97	36.17	36.58	36.76	36.27		
14	2	8	<b>DANDE Sara</b>	ALB		0.74	<b>4:47.68</b>	36.29			
			32.16	1:07.10	1:43.93	2:20.72	2:57.84	3:34.94	4:12.19		
				34.94	36.83	36.79	37.12	37.10	37.25		

NOT CLASSIFIED

1	6	<b>CAMPABADAL Ainhoa</b>	ESP							<b>DNS</b>
---	---	--------------------------	-----	--	--	--	--	--	--	------------

Issued: 05/07/2022 at 10:24



## Results

RANK	LANE	SURNAME & NAME			NOC	BORN			R.T.	TIME	GAP	FINA PTS
		50m	100m	150m		200m	250m	300m				

Event 5  
02/07/2022 - 19:15

### 800m Freestyle Women Final

WR	8:04.79	LEDECKY Kathleen									2016
CR	8:20.78	ALESSIA FILIPPI									2009
WJ	8:11.00	LEDECKY KATHLEEN									2014

### Final

RANK	LANE	SURNAME & NAME	NOC	50m	100m	150m	200m	250m	300m	350m	400m	TIME	GAP	FINA PTS
1	4	<b>TUNCEL Merve</b>	TUR	29.71(1)	1:01.16(1)	1:32.81(1)	2:04.41(1)	2:36.10(1)	3:07.82(1)	3:39.55(1)	4:11.45(1)	<b>8:26.80</b>		
					31.45	31.65	31.60	31.69	31.72	31.73	31.90			
				4:43.26(1)	5:14.98(1)	5:46.92(1)	6:18.89(1)	6:51.03(1)	7:23.10(1)	7:55.15(1)				
				31.81	31.72	31.94	31.97	32.14	32.07	32.05	31.65			
2	3	<b>ERTAN Deniz</b>	TUR	29.76(2)	1:01.62(4)	1:33.38(3)	2:05.39(3)	2:37.17(3)	3:09.18(3)	3:41.05(2)	4:13.10(2)	<b>8:29.03</b>	2.23	
					31.86	31.76	32.01	31.78	32.01	31.87	32.05			
				4:44.99(2)	5:17.10(2)	5:49.22(2)	6:21.38(2)	6:53.46(2)	7:25.62(2)	7:57.71(2)				
				31.89	32.11	32.12	32.16	32.08	32.16	32.09	31.32			
3	5	<b>CARAMIGNOLI Martina Rita</b>	ITA	30.15(4)	1:01.51(2)	1:33.16(2)	2:04.85(2)	2:36.67(2)	3:08.65(2)	3:41.19(3)	4:13.74(3)	<b>8:31.75</b>	4.95	
					31.36	31.65	31.69	31.82	31.98	32.54	32.55			
				4:46.43(3)	5:18.98(3)	5:51.39(3)	6:23.73(3)	6:56.08(3)	7:28.63(3)	8:00.86(3)				
				32.69	32.55	32.41	32.34	32.35	32.55	32.23	30.89			
4	2	<b>TETTAMANZI Alisia</b>	ITA	30.20(5)	1:01.98(5)	1:33.98(5)	2:06.10(5)	2:38.55(5)	3:11.05(5)	3:43.49(4)	4:16.07(4)	<b>8:37.75</b>	10.95	
					31.78	32.00	32.12	32.45	32.50	32.44	32.58			
				4:48.58(4)	5:21.14(4)	5:53.91(4)	6:26.82(4)	6:59.59(4)	7:32.82(4)	8:05.85(4)				
				32.51	32.56	32.77	32.91	32.77	33.23	33.03	31.90			
5	6	<b>HOLUB Tamila Hryhorivna</b>	POR	29.87(3)	1:01.56(3)	1:33.58(4)	2:05.69(4)	2:38.15(4)	3:10.85(4)	3:43.86(5)	4:16.83(5)	<b>8:45.25</b>	18.45	
					31.69	32.02	32.11	32.46	32.70	33.01	32.97			
				4:50.16(5)	5:23.77(5)	5:57.58(5)	6:30.88(5)	7:04.78(5)	7:38.62(5)	8:12.40(5)				
				33.33	33.61	33.81	33.30	33.90	33.84	33.78	32.85			
6	7	<b>TUSEK Dasa</b>	SLO	30.63(6)	1:03.30(6)	1:36.64(6)	2:10.14(6)	2:43.84(6)	3:17.46(6)	3:51.48(6)	4:25.44(6)	<b>8:56.97</b>	30.17	
					32.67	33.34	33.50	33.70	33.62	34.02	33.96			
				4:59.56(6)	5:33.67(6)	6:07.84(6)	6:42.08(6)	7:15.96(6)	7:50.36(6)	8:24.40(6)				
				34.12	34.11	34.17	34.24	33.88	34.40	34.04	32.57			
7	1	<b>DANDE Sara</b>	ALB	31.82(7)	1:07.26(7)	1:44.04(7)	2:21.12(7)	2:58.82(7)	3:36.44(7)	4:13.74(7)	4:51.82(7)	<b>9:52.17</b>	1:25.37	
					35.44	36.78	37.08	37.70	37.62	37.30	38.08			
				5:29.74(7)	6:07.56(7)	6:45.37(7)	7:23.70(7)	8:00.89(7)	8:39.04(7)	9:15.95(7)				
				37.92	37.82	37.81	38.33	37.19	38.15	36.91	36.22			

Issued: 02/07/2022 at 19:37





# Swimming



## Results

RANK LANE SURNAME & NAME NOC BORN R.T. TIME GAP FINA PTS

### Event 18

03/07/2022 - 18:06

### 50m Backstroke Women Final

WR	26.98	LIU Xiang	CHI	2018
CR	28.33	SCALIA SILVIA	ITA	2018
WJ	27.49	ATHERTON MINNA	AUS	2016

### Final

1	4	STANISAVLJEVIC Nina	SRB	0.58	<b>28.59</b>	
2	6	NTOUNTOUNAKI Anna	GRE	0.74	<b>28.68</b>	0.09
3	2	AMADO GOMES Rafaela	POR	0.61	<b>28.86</b>	0.27
4	5	AVRAMOVA Ekaterina	TUR	0.59	<b>28.89</b>	0.30
5	7	ZOFKOVA COSTA Carlotta	ITA	0.70	<b>29.06</b>	0.47
6	3	GASTALDI Anita	ITA	0.59	<b>29.17</b>	0.58
7	1	WEILER SASTRE Carmen	ESP	0.70	<b>29.27</b>	0.68
8	8	ELIGUL Sezin	TUR	0.58	<b>29.37</b>	0.78

Issued: 03/07/2022 at 18:15



# Swimming



## Results

RANK	LANE	SURNAME & NAME	NOC	BORN	R.T.	TIME	GAP	FINA PTS
------	------	----------------	-----	------	------	------	-----	-------------

### Event 18

03/07/2022 - 10:42

## 50m Backstroke Women Preliminary

WR	26.98	LIU Xiang	CHI	2018
CR	28.33	SCALIA SILVIA	ITA	2018
WJ	27.49	ATHERTON MINNA	AUS	2016

### Heat 1 of 2

1	3	AVRAMOVA Ekaterina I.	TUR	0.66	<b>28.83</b>		q
2	4	AMADO GOMES Rafaela	POR	0.64	<b>29.09</b>	0.26	q
3	2	ZOFKOVA COSTA Carlotta	ITA	0.75	<b>29.18</b>	0.35	q
4	6	ELIGUL Sezin	TUR	0.60	<b>29.21</b>	0.38	q
5	5	MUNOZ DEL CAMPO Lidon	ESP	0.68	<b>29.24</b>	0.41	R1
6	7	SACHA Ioanna	GRE	0.64	<b>30.00</b>	1.17	
7	1	ZITOUNI Imene Kawthar	ALG	0.60	<b>31.03</b>	2.20	

Issued: 03/07/2022 at 10:25

### Heat 2 of 2

1	3	STANISAVLJEVIC Nina	SRB	0.60	<b>28.60</b>		q
2	4	GASTALDI Anita	ITA	0.57	<b>29.00</b>	0.40	q
3	7	NTOUNTOUNAKI Anna	GRE	0.56	<b>29.04</b>	0.44	q
4	5	WEILER SASTRE Carmen	ESP	0.64	<b>29.21</b>	0.61	q
5	6	RODRIGUES REBELO Camila	POR	0.64	<b>29.29</b>	0.69	R2
6	1	MELIH Amel	ALG	0.60	<b>29.67</b>	1.07	
7	2	MOREL Emma	FRA	0.59	<b>29.96</b>	1.36	
8	8	RAMIREZ ABELLA Monica	AND	0.64	<b>30.99</b>	2.39	

Issued: 03/07/2022 at 10:30



# Swimming



## Results

RANK HEAT LANE SURNAME & NAME NOC BORN R.T. TIME GAP FINA PTS

### Event 18

03/07/2022 - 10:42

### 50m Backstroke Women Preliminary

WR	26.98	LIU Xiang	CHI	2018
CR	28.33	SCALIA SILVIA	ITA	2018
WJ	27.49	ATHERTON MINNA	AUS	2016

1	2	3	STANISAVLJEVIC Nina	SRB	0.60	<b>28.60</b>		q
2	1	3	AVRAMOVA Ekaterina I.	TUR	0.66	<b>28.83</b>	0.23	q
3	2	4	GASTALDI Anita	ITA	0.57	<b>29.00</b>	0.40	q
4	2	7	NTOUNTOUNAKI Anna	GRE	0.56	<b>29.04</b>	0.44	q
5	1	4	AMADO GOMES Rafaela	POR	0.64	<b>29.09</b>	0.49	q
6	1	2	ZOFKOVA COSTA Carlotta	ITA	0.75	<b>29.18</b>	0.58	q
7	1	6	ELIGUL Sezin	TUR	0.60	<b>29.21</b>	0.61	q
7	2	5	WEILER SASTRE Carmen	ESP	0.64	<b>29.21</b>	0.61	q
9	1	5	MUNOZ DEL CAMPO Lidon	ESP	0.68	<b>29.24</b>	0.64	R1
10	2	6	RODRIGUES REBELO Camila	POR	0.64	<b>29.29</b>	0.69	R2
11	2	1	MELIH Amel	ALG	0.60	<b>29.67</b>	1.07	
12	2	2	MOREL Emma	FRA	0.59	<b>29.96</b>	1.36	
13	1	7	SACHA Ioanna	GRE	0.64	<b>30.00</b>	1.40	
14	2	8	RAMIREZ ABELLA Monica	AND	0.64	<b>30.99</b>	2.39	
15	1	1	ZITOUNI Imene Kawthar	ALG	0.60	<b>31.03</b>	2.43	

Issued: 03/07/2022 at 10:30



# Swimming



## Results

Event 36  
05/07/2022 - 19:04

### 100m Backstroke Women Final

WR	57.45	MCKEOWN Kaylee	AUS	2021
CR	1:00.70	PANZIERA MARGHERITA	ITA	2018
JR	57.57	SMITH REGAN E	USA	2019

### Final

RANK	LANE	SURNAME & NAME	NOC	BORN	R.T.	50m	TIME	GAP	FINA PTS
1	5	RODRIGUES REBELO Camila	POR		0.57	29.95	<b>1:01.34</b> 31.39		
2	3	ZOFKOVA COSTA Carlotta	ITA		0.71	29.84	<b>1:01.61</b> 31.77	0.27	
3	6	WEILER SASTRE Carmen	ESP		0.67	30.46	<b>1:01.98</b> 31.52	0.64	
4	4	AVRAMOVA Ekaterina	TUR		0.61	29.79	<b>1:02.03</b> 32.24	0.69	
5	2	ZAMORANO SANZ Africa	ESP		0.58	30.39	<b>1:02.15</b> 31.76	0.81	
6	7	GASTALDI Anita	ITA		0.60	30.15	<b>1:02.31</b> 32.16	0.97	
7	1	NTOUNTOUNAKI Anna	GRE		0.64	31.25	<b>1:03.51</b> 32.26	2.17	
8	8	SACHA Ioanna	GRE			30.87	<b>1:04.08</b> 33.21	2.74	

Issued: 05/07/2022 at 19:08



# Swimming



## Results

Event 36  
05/07/2022 - 11:21

### 100m Backstroke Women Preliminary

	WR	CR	JR									
	57.45	1:00.70	57.57	MCKEOWN Kaylee	PANZIERA MARGHERITA	SMITH REGAN E	AUS	ITA	USA	2021	2018	2019

#### Heat 1 of 2

RANK	LANE	SURNAME & NAME	NOC	BORN	R.T.	50m	TIME	GAP	FINA PTS
1	5	RODRIGUES REBELO Camila	POR		0.66	30.21	<b>1:01.92</b> 31.71		q
2	3	ZOFKOVA COSTA Carlotta	ITA		0.71	30.45	<b>1:02.19</b> 31.74	0.27	q
3	4	WEILER SASTRE Carmen	ESP		0.68	30.33	<b>1:02.62</b> 32.29	0.70	q
4	6	SACHA Ioanna	GRE		0.59	30.95	<b>1:03.46</b> 32.51	1.54	R1
5	2	PODEVIN Anais Joelle	FRA		0.67	30.86	<b>1:03.84</b> 32.98	1.92	R2
6	7	ZITOUNI Imene Kawthar	ALG		0.55	33.34	<b>1:07.74</b> 34.40	5.82	

Issued: 05/07/2022 at 11:07

#### Heat 2 of 2

RANK	LANE	SURNAME & NAME	NOC	BORN	R.T.	50m	TIME	GAP	FINA PTS
1	4	AVRAMOVA Ekaterina	TUR		0.60	30.48	<b>1:01.89</b> 31.41		q
2	5	ZAMORANO SANZ Africa	ESP		0.56	30.64	<b>1:02.64</b> 32.00	0.75	q
3	6	GASTALDI Anita	ITA		0.59	30.29	<b>1:03.10</b> 32.81	1.21	q
4	7	NTOUNTOUNAKI Anna	GRE		0.65	30.51	<b>1:03.21</b> 32.70	1.32	q
5	2	SEGEL Janja	SLO		0.67	30.33	<b>1:03.22</b> 32.89	1.33	q
6	3	AMADO GOMES Rafaela	POR		0.64	30.73	<b>1:04.81</b> 34.08	2.92	

Issued: 05/07/2022 at 11:12



# Swimming



## Results

RANK HEAT LANE SURNAME & NAME NOC BORN R.T. 50m TIME GAP FINA PTS

### Event 36

05/07/2022 - 11:21

### 100m Backstroke Women Preliminary

WR	57.45	MCKEOWN Kaylee	AUS	2021
CR	1:00.70	PANZIERA MARGHERITA	ITA	2018
JR	57.57	SMITH REGAN E	USA	2019

RANK	HEAT	LANE	SURNAME & NAME	NOC	BORN	R.T.	50m	TIME	GAP	FINA PTS
1	2	4	AVRAMOVA Ekaterina	TUR		0.60	30.48	<b>1:01.89</b> 31.41		q
2	1	5	RODRIGUES REBELO Camila	POR		0.66	30.21	<b>1:01.92</b> 31.71	0.03	q
3	1	3	ZOFKOVA COSTA Carlotta	ITA		0.71	30.45	<b>1:02.19</b> 31.74	0.30	q
4	1	4	WEILER SASTRE Carmen	ESP		0.68	30.33	<b>1:02.62</b> 32.29	0.73	q
5	2	5	ZAMORANO SANZ Africa	ESP		0.56	30.64	<b>1:02.64</b> 32.00	0.75	q
6	2	6	GASTALDI Anita	ITA		0.59	30.29	<b>1:03.10</b> 32.81	1.21	q
7	2	7	NTOUNTOUNAKI Anna	GRE		0.65	30.51	<b>1:03.21</b> 32.70	1.32	q
8	2	2	SEGEL Janja	SLO		0.67	30.33	<b>1:03.22</b> 32.89	1.33	q
9	1	6	SACHA Ioanna	GRE		0.59	30.95	<b>1:03.46</b> 32.51	1.57	R1
10	1	2	PODEVIN Anais Joelle	FRA		0.67	30.86	<b>1:03.84</b> 32.98	1.95	R2
11	2	3	AMADO GOMES Rafaela	POR		0.64	30.73	<b>1:04.81</b> 34.08	2.92	
12	1	7	ZITOUNI Imene Kawthar	ALG		0.55	33.34	<b>1:07.74</b> 34.40	5.85	

Issued: 05/07/2022 at 11:12

# Swimming



## Results

RANK	LANE	SURNAME & NAME	NOC	BORN	R.T.	50m	100m	150m	TIME	GAP	FINA PTS
------	------	----------------	-----	------	------	-----	------	------	------	-----	-------------

Event 15  
02/07/2022 - 19:37

### 200m Backstroke Women Final

WR	2:03.35	SMITH Regan E	USA	2019
CR	2:08.03	ALESSIA FILIPPI	ITA	2009
JR	2:03.35	SMITH REGAN E	USA	2019

#### Final

1	5	RODRIGUES REBELO Camila	POR	0.63	31.00	1:04.29 33.29	1:37.77 33.48	<b>2:10.41</b> 32.64	
2	4	ZAMORANO SANZ Africa	ESP	0.54	30.88	1:04.26 33.38	1:38.32 34.06	<b>2:11.48</b> 33.16	1.07
3	3	AVRAMOVA Ekaterina	TUR	0.63	31.25	1:04.90 33.65	1:39.09 34.19	<b>2:12.72</b> 33.63	2.31
4	2	WEILER SASTRE Carmen	ESP	0.66	31.29	1:04.88 33.59	1:39.04 34.16	<b>2:12.96</b> 33.92	2.55
5	6	CENCI Martina	ITA	0.70	31.58	1:05.49 33.91	1:39.76 34.27	<b>2:13.82</b> 34.06	3.41
6	8	DENIZLI Sudem	TUR	0.61	31.64	1:05.46 33.82	1:40.71 35.25	<b>2:14.96</b> 34.25	4.55
7	7	PODEVIN Anais Joelle	FRA	0.58	31.54	1:05.80 34.26	1:41.12 35.32	<b>2:15.28</b> 34.16	4.87
8	1	FURFARO Francesca Romana	ITA	0.59	31.43	1:05.99 34.56	1:41.15 35.16	<b>2:17.15</b> 36.00	6.74

Issued: 02/07/2022 at 19:50

# Swimming



## Results

RANK	LANE	SURNAME & NAME	NOC	BORN	R.T.	50m	100m	150m	TIME	GAP	FINA PTS
------	------	----------------	-----	------	------	-----	------	------	------	-----	-------------

Event 15  
02/07/2022 - 11:29

### 200m Backstroke Women Preliminary

WR	2:03.35	SMITH Regan E							USA		2019
CR	2:08.03	ALESSIA FILIPPI							ITA		2009
WJ	2:03.35	SMITH REGAN E							USA		2019

#### Heat 1 of 2

1	4	RODRIGUES REBELO Camila	POR		0.61	31.25	1:04.78 33.53	1:39.10 34.32	<b>2:13.77</b> 34.67		q
2	6	FURFARO Francesca Romana	ITA		0.58	31.83	1:06.38 34.55	1:41.29 34.91	<b>2:15.62</b> 34.33	1.85	q
3	5	DENIZLI Sudem	TUR		0.63	32.00	1:05.85 33.85	1:40.93 35.08	<b>2:15.87</b> 34.94	2.10	q
4	3	SACHA Ioanna	GRE		0.62	31.87	1:06.15 34.28	1:41.07 34.92	<b>2:16.82</b> 35.75	3.05	R1
5	2	ZITOUNI Imene Kawthar	ALG		0.59	32.78	1:08.53 35.75	1:46.10 37.57	<b>2:21.88</b> 35.78	8.11	R2

Issued: 02/07/2022 at 11:15

#### Heat 2 of 2

1	4	ZAMORANO SANZ Africa	ESP		0.56	31.24	1:05.03 33.79	1:39.48 34.45	<b>2:13.52</b> 34.04		q
2	3	AVRAMOVA Ekaterina I.	TUR		0.63	31.33	1:05.24 33.91	1:39.91 34.67	<b>2:13.80</b> 33.89	0.28	q
3	6	CENCI Martina	ITA		0.63	31.49	1:05.65 34.16	1:40.46 34.81	<b>2:14.56</b> 34.10	1.04	q
4	5	WEILER SASTRE Carmen	ESP		0.65	30.88	1:04.38 33.50	1:39.31 34.93	<b>2:14.78</b> 35.47	1.26	q
5	2	PODEVIN Anais Joelle	FRA		0.61	31.92	1:06.59 34.67	1:41.18 34.59	<b>2:15.58</b> 34.40	2.06	q
6	7	BENCHADLI Jihane	ALG		0.72	34.14	1:10.29 36.15	1:47.24 36.95	<b>2:24.17</b> 36.93	10.65	

Issued: 02/07/2022 at 11:22



# Swimming



## Results

RANK HEAT LANE SURNAME & NAME NOC BORN R.T. 50m 100m 150m TIME GAP FINA PTS

### Event 15

02/07/2022 - 11:29

## 200m Backstroke Women Preliminary

WR	2:03.35	SMITH Regan E	USA	2019
CR	2:08.03	ALESSIA FILIPPI	ITA	2009
WJ	2:03.35	SMITH REGAN E	USA	2019

RANK	HEAT	LANE	SURNAME & NAME	NOC	BORN	R.T.	50m	100m	150m	TIME	GAP	FINA PTS
1	2	4	ZAMORANO SANZ Africa	ESP		0.56	31.24	1:05.03 33.79	1:39.48 34.45	<b>2:13.52</b> 34.04		q
2	1	4	RODRIGUES REBELO Camila	POR		0.61	31.25	1:04.78 33.53	1:39.10 34.32	<b>2:13.77</b> 34.67	0.25	q
3	2	3	AVRAMOVA Ekaterina I.	TUR		0.63	31.33	1:05.24 33.91	1:39.91 34.67	<b>2:13.80</b> 33.89	0.28	q
4	2	6	CENCI Martina	ITA		0.63	31.49	1:05.65 34.16	1:40.46 34.81	<b>2:14.56</b> 34.10	1.04	q
5	2	5	WEILER SASTRE Carmen	ESP		0.65	30.88	1:04.38 33.50	1:39.31 34.93	<b>2:14.78</b> 35.47	1.26	q
6	2	2	PODEVIN Anais Joelle	FRA		0.61	31.92	1:06.59 34.67	1:41.18 34.59	<b>2:15.58</b> 34.40	2.06	q
7	1	6	FURFARO Francesca Romana	ITA		0.58	31.83	1:06.38 34.55	1:41.29 34.91	<b>2:15.62</b> 34.33	2.10	q
8	1	5	DENIZLI Sudem	TUR		0.63	32.00	1:05.85 33.85	1:40.93 35.08	<b>2:15.87</b> 34.94	2.35	q
9	1	3	SACHA Ioanna	GRE		0.62	31.87	1:06.15 34.28	1:41.07 34.92	<b>2:16.82</b> 35.75	3.30	R1
10	1	2	ZITOUNI Imene Kawthar	ALG		0.59	32.78	1:08.53 35.75	1:46.10 37.57	<b>2:21.88</b> 35.78	8.36	R2
11	2	7	BENCHADLI Jihane	ALG		0.72	34.14	1:10.29 36.15	1:47.24 36.95	<b>2:24.17</b> 36.93	10.65	

Issued: 02/07/2022 at 11:22



# Swimming



## Results

RANK LANE SURNAME & NAME NOC BORN R.T. TIME GAP FINA PTS

### Event 24

04/07/2022 - 18:00

### 50m Breaststroke Women Final

WR	29.30	PILATO Benedetta	ITA	2021
CR	31.07	CASTIGLIONI ARIANNA	ITA	2018
JR	29.30	PILATO BENEDETTA	ITA	2016

### Final

RANK	LANE	SURNAME & NAME	NOC	BORN	R.T.	TIME	GAP	FINA PTS
1	4	ANGIOLINI Lisa	ITA		0.74	<b>30.87</b>		CR
2	5	DE PINHO RODRIGUES Ana	POR		0.66	<b>31.31</b>	0.44	
3	2	BOTTAZZO Anita	ITA		0.63	<b>31.41</b>	0.54	
4	6	DRASIDOU Maria Thaleia	GRE		0.66	<b>31.64</b>	0.77	
5	3	VOVK Tara	SLO		0.67	<b>31.75</b>	0.88	
6	7	GARCIA URZAINQUI Marina	ESP		0.70	<b>32.02</b>	1.15	
7	8	PINTAR Tjasa	SLO		0.67	<b>32.11</b>	1.24	
8	1	ANGELAKI Chara	GRE		0.68	<b>32.24</b>	1.37	

Issued: 04/07/2022 at 18:02



# Swimming



## Results

RANK	LANE	SURNAME & NAME	NOC	BORN	R.T.	TIME	GAP	FINA PTS
------	------	----------------	-----	------	------	------	-----	-------------

### Event 24

04/07/2022 - 10:00

## 50m Breaststroke Women Preliminary

WR	29.30	PILATO Benedetta	ITA					2021
CR	31.07	CASTIGLIONI ARIANNA	ITA					2018
JR	29.30	PILATO BENEDETTA	ITA					2016

### Heat 1 of 2

1	4	ANGIOLINI Lisa	ITA		0.73	<b>31.22</b>		q
2	5	VOVK Tara	SLO		0.68	<b>31.39</b>	0.17	q
3	6	GARCIA URZAINQUI Marina	ESP		0.68	<b>31.90</b>	0.68	q
4	3	GUNES Viktoria	TUR		0.69	<b>32.19</b>	0.97	q
5	2	BEKA Vanesa	KOS		0.66	<b>37.14</b>	5.92	

Issued: 04/07/2022 at 10:02

### Heat 2 of 2

1	3	DE PINHO RODRIGUES Ana	POR		0.63	<b>31.36</b>		q
2	4	DRASIDOU Maria Thaleia	GRE		0.64	<b>31.51</b>	0.15	q
3	5	BOTTAZZO Anita	ITA		0.65	<b>31.66</b>	0.30	q
4	6	ANGELAKI Chara	GRE		0.65	<b>31.94</b>	0.58	q
5	2	PINTAR Tjasa	SLO		0.65	<b>32.25</b>	0.89	R1
6	7	VERDINO Claudia	MON		0.72	<b>34.33</b>	2.97	R2

Issued: 04/07/2022 at 10:06



# Swimming



## Results

RANK HEAT LANE SURNAME & NAME NOC BORN R.T. TIME GAP FINA PTS

### Event 24

04/07/2022 - 10:00

### 50m Breaststroke Women Preliminary

WR	29.30	PILATO Benedetta	ITA	2021
CR	31.07	CASTIGLIONI ARIANNA	ITA	2018
JR	29.30	PILATO BENEDETTA	ITA	2016

RANK	HEAT	LANE	SURNAME & NAME	NOC	BORN	R.T.	TIME	GAP	FINA PTS
1	1	4	ANGIOLINI Lisa	ITA		0.73	<b>31.22</b>		q
2	2	3	DE PINHO RODRIGUES Ana	POR		0.63	<b>31.36</b>	0.14	q
3	1	5	VOVK Tara	SLO		0.68	<b>31.39</b>	0.17	q
4	2	4	DRASIDOU Maria Thaleia	GRE		0.64	<b>31.51</b>	0.29	q
5	2	5	BOTTAZZO Anita	ITA		0.65	<b>31.66</b>	0.44	q
6	1	6	GARCIA URZAINQUI Marina	ESP		0.68	<b>31.90</b>	0.68	q
7	2	6	ANGELAKI Chara	GRE		0.65	<b>31.94</b>	0.72	q
8	1	3	GUNES Viktoria	TUR		0.69	<b>32.19</b>	0.97	q
9	2	2	PINTAR Tjasa	SLO		0.65	<b>32.25</b>	1.03	R1
10	2	7	VERDINO Claudia	MON		0.72	<b>34.33</b>	3.11	R2
11	1	2	BEKA Vanesa	KOS		0.66	<b>37.14</b>	5.92	

Issued: 04/07/2022 at 10:06



## Results

RANK	LANE	SURNAME & NAME	NOC	BORN	R.T.	50m	TIME	GAP	FINA PTS
------	------	----------------	-----	------	------	-----	------	-----	-------------

### Event 13

02/07/2022 - 18:45

## 100m Breaststroke Women Final

WR	1:04.13	KING Lillia C	USA	2017
CR	1:07.19	VALMONTERO JESSICA	ESP	2018
WJ	1:04.35	MEILUTYTE RUTA	LTU	2013

### Final

1	4	ANGIOLINI Lisa	ITA	0.75	31.81	<b>1:07.59</b> 35.78	
2	5	BOTTAZZO Anita	ITA	0.67	32.02	<b>1:08.14</b> 36.12	0.55
3	3	GUNES Viktoria Z.	TUR	0.72	32.06	<b>1:08.44</b> 36.38	0.85
4	6	GARCIA URZAINQUI Marina	ESP	0.75	32.63	<b>1:08.91</b> 36.28	1.32
5	7	VOVK Tara	SLO	0.68	32.42	<b>1:09.16</b> 36.74	1.57
6	8	DE PINHO RODRIGUES Ana	POR	0.69	31.92	<b>1:09.42</b> 37.50	1.83
7	2	BLAZEVIC Ana	CRO	0.73	32.89	<b>1:09.60</b> 36.71	2.01
8	1	ANGELAKI Chara	GRE	0.68	32.74	<b>1:09.88</b> 37.14	2.29

Issued: 02/07/2022 at 18:55



# Swimming



## Results

Event 13  
02/07/2022 - 10:50

### 100m Breaststroke Women Preliminary

RANK	LANE	SURNAME & NAME	NOC	BORN	R.T.	50m	TIME	GAP	FINA PTS
WR	1:04.13	KING Lillia C	USA						2017
CR	1:07.19	VALMONTERO JESSICA	ESP						2018
WJ	1:04.35	MEILUTYTE RUTA	LTU						2013

#### Heat 1 of 2

1	4	BOTTAZZO Anita	ITA		0.67	32.22	<b>1:08.84</b> 36.62		q
2	5	GARCIA URZAINQUI Marina	ESP		0.73	33.03	<b>1:09.21</b> 36.18	0.37	q
3	3	VOVK Tara	SLO		0.69	32.46	<b>1:09.97</b> 37.51	1.13	q
4	6	ANGELAKI Chara	GRE		0.68	32.65	<b>1:10.04</b> 37.39	1.20	q
5	2	PINTAR Tjasa	SLO		0.70	33.15	<b>1:10.98</b> 37.83	2.14	R1
6	7	BEKA Vanesa	KOS		0.67	36.70	<b>1:20.87</b> 44.17	12.03	

Issued: 02/07/2022 at 10:49

#### Heat 2 of 2

1	4	ANGIOLINI Lisa	ITA		0.73	31.88	<b>1:07.77</b> 35.89		q
2	5	GUNES Viktoria Z.	TUR		0.70	32.36	<b>1:08.85</b> 36.49	1.08	q
3	6	BLAZEVIC Ana	CRO		0.71	33.05	<b>1:09.79</b> 36.74	2.02	q
4	3	DE PINHO RODRIGUES Ana	POR		0.69	32.75	<b>1:10.56</b> 37.81	2.79	q
5	2	DRASIDOU Maria Thaleia	GRE		0.67	33.36	<b>1:11.29</b> 37.93	3.52	R2
6	1	TUDO CUBELLS Nadia	AND		0.69	34.33	<b>1:13.25</b> 38.92	5.48	
7	7	VERDINO Claudia	MON		0.74	35.45	<b>1:17.41</b> 41.96	9.64	

Issued: 02/07/2022 at 10:53



# Swimming



## Results

RANK HEAT LANE SURNAME & NAME NOC BORN R.T. 50m TIME GAP FINA PTS

### Event 13

02/07/2022 - 10:50

### 100m Breaststroke Women Preliminary

WR	1:04.13	KING Lillia C	USA	2017
CR	1:07.19	VALMONTERO JESSICA	ESP	2018
WJ	1:04.35	MEILUTYTE RUTA	LTU	2013

RANK	HEAT	LANE	SURNAME & NAME	NOC	BORN	R.T.	50m	TIME	GAP	FINA PTS
1	2	4	ANGIOLINI Lisa	ITA		0.73	31.88	<b>1:07.77</b> 35.89		q
2	1	4	BOTTAZZO Anita	ITA		0.67	32.22	<b>1:08.84</b> 36.62	1.07	q
3	2	5	GUNES Viktoria Z.	TUR		0.70	32.36	<b>1:08.85</b> 36.49	1.08	q
4	1	5	GARCIA URZAINQUI Marina	ESP		0.73	33.03	<b>1:09.21</b> 36.18	1.44	q
5	2	6	BLAZEVIC Ana	CRO		0.71	33.05	<b>1:09.79</b> 36.74	2.02	q
6	1	3	VOVK Tara	SLO		0.69	32.46	<b>1:09.97</b> 37.51	2.20	q
7	1	6	ANGELAKI Chara	GRE		0.68	32.65	<b>1:10.04</b> 37.39	2.27	q
8	2	3	DE PINHO RODRIGUES Ana	POR		0.69	32.75	<b>1:10.56</b> 37.81	2.79	q
9	1	2	PINTAR Tjasa	SLO		0.70	33.15	<b>1:10.98</b> 37.83	3.21	R1
10	2	2	DRASIDOU Maria Thaleia	GRE		0.67	33.36	<b>1:11.29</b> 37.93	3.52	R2
11	2	1	TUDO CUBELLS Nadia	AND		0.69	34.33	<b>1:13.25</b> 38.92	5.48	
12	2	7	VERDINO Claudia	MON		0.74	35.45	<b>1:17.41</b> 41.96	9.64	
13	1	7	BEKA Vanesa	KOS		0.67	36.70	<b>1:20.87</b> 44.17	13.10	

Issued: 02/07/2022 at 10:53

# Swimming



## Results

RANK	LANE	SURNAME & NAME	NOC	BORN	R.T.	50m	100m	150m	TIME	GAP	FINA PTS
------	------	----------------	-----	------	------	-----	------	------	------	-----	-------------

### Event 34

05/07/2022 - 18:35

## 200m Breaststroke Women Final

WR	2:18.95	SCHOENMAKER Tatjana R	RSA	2021
CR	2:25.22	VALMONTERO JESSICA	ESP	2018
JR	2:19.64	GUNES VIKTORIA ZEYNEP	TUR	2015

### Final

1	3	GUNES Viktoria	TUR	0.71	33.17	1:10.02 36.85	1:47.67 37.65	<b>2:26.48</b> 38.81	
2	4	GARCIA URZAINQUI Marina	ESP	0.69	33.26	1:10.55 37.29	1:48.41 37.86	<b>2:27.32</b> 38.91	0.84
3	6	GOMES RAMOS Raquel	POR	0.74	33.78	1:11.31 37.53	1:49.56 38.25	<b>2:28.35</b> 38.79	1.87
4	5	BLAZEVIC Ana	CRO	0.69	33.05	1:10.23 37.18	1:49.13 38.90	<b>2:30.15</b> 41.02	3.67
5	2	ANGIOLINI Lisa	ITA	0.75	32.97	1:10.78 37.81	1:49.30 38.52	<b>2:30.26</b> 40.96	3.78
6	7	VAZQUEZ RUIZ Alba	ESP	0.73	34.43	1:12.68 38.25	1:51.70 39.02	<b>2:31.28</b> 39.58	4.80
7	8	ANGELAKI Chara	GRE	0.69	34.67	1:13.51 38.84	1:53.15 39.64	<b>2:33.33</b> 40.18	6.85
8	1	CAVAGNOLI Vanessa	ITA	0.74	34.99	1:14.22 39.23	1:55.10 40.88	<b>2:37.82</b> 42.72	11.34

Issued: 05/07/2022 at 18:42





# Swimming



## Results

Event 34  
05/07/2022 - 11:01

### 200m Breaststroke Women Preliminary

WR	2:18.95	SCHOENMAKER Tatjana R	RSA	2021
CR	2:25.22	VALMONTERO JESSICA	ESP	2018
JR	2:19.64	GUNES VIKTORIA ZEYNEP	TUR	2015

#### Heat 1 of 2

RANK	LANE	SURNAME & NAME	NOC	BORN	R.T.	50m	100m	150m	TIME	GAP	FINA PTS
1	5	GOMES RAMOS Raquel	POR		0.74	34.14	1:12.94 38.80	1:52.95 40.01	<b>2:32.79</b> 39.84		q
2	4	ANGIOLINI Lisa	ITA		0.75	34.09	1:13.11 39.02	1:52.31 39.20	<b>2:32.97</b> 40.66	0.18	q
3	3	CAVAGNOLI Vanessa	ITA		0.73	34.96	1:14.16 39.20	1:54.17 40.01	<b>2:36.23</b> 42.06	3.44	q
4	2	TUDO CUBELLS Nadia	AND		0.70	35.97	1:15.79 39.82	1:56.24 40.45	<b>2:37.60</b> 41.36	4.81	R1
5	6	NEFSI Hamida Rania	ALG		0.74	36.95	1:18.04 41.09	1:59.14 41.10	<b>2:39.52</b> 40.38	6.73	R2

Issued: 05/07/2022 at 10:44

#### Heat 2 of 2

1	4	GARCIA URZAINQUI Marina	ESP		0.69	33.81	1:11.97 38.16	1:50.49 38.52	<b>2:29.43</b> 38.94		q
2	3	BLAZEVIC Ana	CRO		0.71	33.81	1:11.91 38.10	1:50.79 38.88	<b>2:30.79</b> 40.00	1.36	q
3	5	GUNES Viktoria	TUR		0.68	34.01	1:12.32 38.31	1:51.40 39.08	<b>2:31.53</b> 40.13	2.10	q
4	2	VAZQUEZ RUIZ Alba	ESP		0.72	35.55	1:14.61 39.06	1:54.22 39.61	<b>2:34.47</b> 40.25	5.04	q
5	6	ANGELAKI Chara	GRE		0.69	35.22	1:14.18 38.96	1:54.91 40.73	<b>2:36.79</b> 41.88	7.36	q

Issued: 05/07/2022 at 10:50



# Swimming



## Results

RANK	HEAT	LANE	SURNAME & NAME	NOC	BORN	R.T.	50m	100m	150m	TIME	GAP	FINA PTS
------	------	------	----------------	-----	------	------	-----	------	------	------	-----	-------------

### Event 34

05/07/2022 - 11:01

## 200m Breaststroke Women Preliminary

WR	2:18.95	SCHOENMAKER Tatjana R	RSA	2021
CR	2:25.22	VALMONTERO JESSICA	ESP	2018
JR	2:19.64	GUNES VIKTORIA ZEYNEP	TUR	2015

1	2	4	GARCIA URZAINQUI Marina	ESP		0.69	33.81	1:11.97 38.16	1:50.49 38.52	<b>2:29.43</b> 38.94		q
2	2	3	BLAZEVIC Ana	CRO		0.71	33.81	1:11.91 38.10	1:50.79 38.88	<b>2:30.79</b> 40.00	1.36	q
3	2	5	GUNES Viktoria	TUR		0.68	34.01	1:12.32 38.31	1:51.40 39.08	<b>2:31.53</b> 40.13	2.10	q
4	1	5	GOMES RAMOS Raquel	POR		0.74	34.14	1:12.94 38.80	1:52.95 40.01	<b>2:32.79</b> 39.84	3.36	q
5	1	4	ANGIOLINI Lisa	ITA		0.75	34.09	1:13.11 39.02	1:52.31 39.20	<b>2:32.97</b> 40.66	3.54	q
6	2	2	VAZQUEZ RUIZ Alba	ESP		0.72	35.55	1:14.61 39.06	1:54.22 39.61	<b>2:34.47</b> 40.25	5.04	q
7	1	3	CAVAGNOLI Vanessa	ITA		0.73	34.96	1:14.16 39.20	1:54.17 40.01	<b>2:36.23</b> 42.06	6.80	q
8	2	6	ANGELAKI Chara	GRE		0.69	35.22	1:14.18 38.96	1:54.91 40.73	<b>2:36.79</b> 41.88	7.36	q
9	1	2	TUDO CUBELLS Nadia	AND		0.70	35.97	1:15.79 39.82	1:56.24 40.45	<b>2:37.60</b> 41.36	8.17	R1
10	1	6	NEFSI Hamida Rania	ALG		0.74	36.95	1:18.04 41.09	1:59.14 41.10	<b>2:39.52</b> 40.38	10.09	R2

Issued: 05/07/2022 at 10:50



# Swimming



## Results

RANK LANE SURNAME & NAME NOC BORN R.T. TIME GAP FINA PTS

### Event 9

02/07/2022 - 18:00

### 50m Butterfly Women Final

WR	24.43	SJOESTROEM SARAH	SWE	2014
CR	25.48	OSMAN FARIDA	EGY	2018
WJ	25.46	IKEE RAIKO	JPN	2017

### Final

1	3	NTOUNTOUNAKI Anna	GRE	0.65	<b>25.95</b>	
2	4	SCOTTO DI CARLO Viola	ITA	0.67	<b>26.25</b>	0.30
3	6	LAQUINTANA Sonia	ITA	0.69	<b>26.38</b>	0.43
4	5	KLANCAR Neza	SLO	0.74	<b>26.45</b>	0.50
5	2	PUDAR Lana	BIH	0.74	<b>26.77</b>	0.82
6	7	FREITAS GUEDES Ana	POR	0.60	<b>26.96</b>	1.01
7	8	PACHECO DE SOUSA Mariana	POR	0.73	<b>27.09</b>	1.14
8	1	MOREL Emma	FRA	0.68	<b>27.50</b>	1.55

Issued: 02/07/2022 at 18:04



# Swimming



## Results

### Event 9

02/07/2022 - 10:00

### 50m Butterfly Women Preliminary

RANK	LANE	SURNAME & NAME	NOC	BORN	R.T.	TIME	GAP	FINA PTS
WR	24.43	SJOESTROEM SARAH	SWE					2014
CR	25.48	OSMAN FARIDA	EGY					2018

#### Heat 1 of 3

1	4	SCOTTO DI CARLO Viola	ITA		0.68	26.48		q
2	5	LAQUINTANA Sonia	ITA		0.80	26.77	0.29	q
3	3	PACHECO SE SOUSA ALMEIDA	POR		0.79	27.20	0.72	q
4	6	MELIH Amel	ALG		0.78	27.59	1.11	
5	2	ANTONIOU Kalia	CYP		0.79	27.68	1.20	

Issued: 02/07/2022 at 10:02

#### Heat 2 of 3

1	4	KLANCAR Neza	SLO		0.74	26.51		q
2	7	PUDAR Lana	BIH		0.85	26.78	0.27	q
3	5	MUNOZ DEL CAMPO Lidon	ESP		0.69	27.25	0.74	R1
4	6	STANISAVLJEVIC Nina	SRB		0.66	27.44	0.93	R2
5	3	DAMASIOTI Georgia	GRE		0.71	27.55	1.04	
6	2	HURTADO SIRERA Carla	ESP		0.69	28.21	1.70	

Issued: 02/07/2022 at 10:05

#### Heat 3 of 3

1	4	NTOUNTOUNAKI Anna	GRE		0.64	26.60		q
2	5	FREITAS GUEDES Ana Marga	POR		0.62	26.96	0.36	q
3	3	MOREL Emma	FRA		0.71	26.99	0.39	q
4	6	ELIGUL Sezin	TUR		0.64	27.46	0.86	
5	7	MEDJAHED Nesrine	ALG		0.67	28.44	1.84	
6	2	DONMEZ Ecem	TUR		0.68	29.47	2.87	

Issued: 02/07/2022 at 10:07



# Swimming



## Results

RANK HEAT LANE SURNAME & NAME NOC BORN R.T. TIME GAP FINA PTS

### Event 9

02/07/2022 - 10:00

### 50m Butterfly Women Preliminary

WR	24.43	SJOESTROEM SARAH	SWE	2014
CR	25.48	OSMAN FARIDA	EGY	2018
JJ	25.46	IKEE RAIKO	JPN	2017

RANK	HEAT	LANE	SURNAME & NAME	NOC	BORN	R.T.	TIME	GAP	FINA PTS
1	1	4	SCOTTO DI CARLO Viola	ITA		0.68	<b>26.48</b>		q
2	2	4	KLANCAR Neza	SLO		0.74	<b>26.51</b>	0.03	q
3	3	4	NTOUNTOUNAKI Anna	GRE		0.64	<b>26.60</b>	0.12	q
4	1	5	LAQUINTANA Sonia	ITA		0.80	<b>26.77</b>	0.29	q
5	2	7	PUDAR Lana	BIH		0.85	<b>26.78</b>	0.30	q
6	3	5	FREITAS GUEDES Ana Marga	POR		0.62	<b>26.96</b>	0.48	q
7	3	3	MOREL Emma	FRA		0.71	<b>26.99</b>	0.51	q
8	1	3	PACHECO SE SOUSA ALMEIDA	POR		0.79	<b>27.20</b>	0.72	q
9	2	5	MUNOZ DEL CAMPO Lidon	ESP		0.69	<b>27.25</b>	0.77	R1
10	2	6	STANISAVLJEVIC Nina	SRB		0.66	<b>27.44</b>	0.96	R2
11	3	6	ELIGUL Sezin	TUR		0.64	<b>27.46</b>	0.98	
12	2	3	DAMASIOTI Georgia	GRE		0.71	<b>27.55</b>	1.07	
13	1	6	MELIH Amel	ALG		0.78	<b>27.59</b>	1.11	
14	1	2	ANTONIOU Kalia	CYP		0.79	<b>27.68</b>	1.20	
15	2	2	HURTADO SIRERA Carla	ESP		0.69	<b>28.21</b>	1.73	
16	3	7	MEDJAHED Nesrine	ALG		0.67	<b>28.44</b>	1.96	
17	3	2	DONMEZ Ecem	TUR		0.68	<b>29.47</b>	2.99	

Issued: 02/07/2022 at 10:08



# Swimming



## Results

RANK	LANE	SURNAME & NAME	NOC	BORN	R.T.	50m	TIME	GAP	FINA PTS
------	------	----------------	-----	------	------	-----	------	-----	-------------

Event 26  
04/07/2022 - 18:16

### 100m Butterfly Women Final

WR	55.48	SJOESTROEM SARAH	SWE	2016
CR	57.59	DILIDDO ELENA	ITA	2018
JR	56.43	CURZAN CLAIRE M	USA	2017

### Final

1	5	PUDAR Lana	BIH	0.74	27.04	<b>57.55</b> 30.51		CR
2	7	NTOUNTOUNAKI Anna	GRE	0.64	27.31	<b>58.56</b> 31.25	1.01	
3	4	BIANCHI Ilaria	ITA	0.67	27.45	<b>59.06</b> 31.61	1.51	
4	6	PACHECO DE SOUSA Mariana	POR	0.68	27.74	<b>59.36</b> 31.62	1.81	
5	1	DAMASIOTI Georgia	GRE	0.67	27.62	<b>59.40</b> 31.78	1.85	
6	3	TARZIA Claudia	ITA	0.71	27.93	<b>59.41</b> 31.48	1.86	
7	2	CUNHA Ana	POR	0.65	28.32	<b>1:00.13</b> 31.81	2.58	
8	8	HURTADO SIRERA Carla	ESP	0.68	28.56	<b>1:01.03</b> 32.47	3.48	

Issued: 04/07/2022 at 18:23

# Swimming



## Results

RANK	LANE	SURNAME & NAME	NOC	BORN	R.T.	50m	TIME	GAP	FINA PTS
------	------	----------------	-----	------	------	-----	------	-----	-------------

Event 26  
04/07/2022 - 10:20

### 100m Butterfly Women Preliminary

WR	55.48	SJOESTROEM SARAH	SWE	2016
CR	57.59	DILIDDO ELENA	ITA	2018
JR	56.43	CURZAN CLAIRE M	USA	2017

#### Heat 1 of 2

1	4	BIANCHI Ilaria	ITA	0.70	27.33	<b>59.55</b> 32.22		q
2	5	TARZIA Claudia	ITA	0.72	28.04	<b>1:00.05</b> 32.01	0.50	q
3	3	CUNHA Ana	POR	0.70	28.43	<b>1:00.59</b> 32.16	1.04	q
4	6	HURTADO SIRERA Carla	ESP	0.67	29.09	<b>1:01.53</b> 32.44	1.98	q
5	2	MARCHAND Juliette Marie	FRA	0.73	29.48	<b>1:02.43</b> 32.95	2.88	R2
6	7	MIDOUNI Lilia Sihem	ALG	0.72	30.17	<b>1:05.53</b> 35.36	5.98	

Issued: 04/07/2022 at 10:20

#### Heat 2 of 2

1	1	PUDAR Lana	BIH	0.73	27.83	<b>59.81</b> 31.98		q
2	3	PACHECO DE SOUSA Mariana	POR	0.68	28.14	<b>1:00.47</b> 32.33	0.66	q
3	4	NTOUNTOUNAKI Anna	GRE	0.63	28.46	<b>1:00.62</b> 32.16	0.81	q
4	5	DAMASIOTI Georgia	GRE	0.71	28.92	<b>1:00.79</b> 31.87	0.98	q
5	6	MOREL Emma	FRA	0.66	29.23	<b>1:02.37</b> 33.14	2.56	R1
6	7	PUJADAS RUSINOL Julia	ESP	0.68	29.56	<b>1:03.45</b> 33.89	3.64	
7	2	TACYILDIZ Defne	TUR	0.69	29.42	<b>1:03.99</b> 34.57	4.18	

Issued: 04/07/2022 at 10:24

# Swimming



## Results

RANK HEAT LANE SURNAME & NAME NOC BORN R.T. 50m TIME GAP FINA PTS

### Event 26

04/07/2022 - 10:20

### 100m Butterfly Women Preliminary

WR	55.48	SJOESTROEM SARAH	SWE	2016
CR	57.59	DILIDDO ELENA	ITA	2018
JR	56.43	CURZAN CLAIRE M	USA	2017

RANK	HEAT	LANE	SURNAME & NAME	NOC	BORN	R.T.	50m	TIME	GAP	FINA PTS
1	1	4	BIANCHI Ilaria	ITA		0.70	27.33	<b>59.55</b> 32.22		q
2	2	1	PUDAR Lana	BIH		0.73	27.83	<b>59.81</b> 31.98	0.26	q
3	1	5	TARZIA Claudia	ITA		0.72	28.04	<b>1:00.05</b> 32.01	0.50	q
4	2	3	PACHECO DE SOUSA Mariana	POR		0.68	28.14	<b>1:00.47</b> 32.33	0.92	q
5	1	3	CUNHA Ana	POR		0.70	28.43	<b>1:00.59</b> 32.16	1.04	q
6	2	4	NTOUNTOUNAKI Anna	GRE		0.63	28.46	<b>1:00.62</b> 32.16	1.07	q
7	2	5	DAMASIOTI Georgia	GRE		0.71	28.92	<b>1:00.79</b> 31.87	1.24	q
8	1	6	HURTADO SIRERA Carla	ESP		0.67	29.09	<b>1:01.53</b> 32.44	1.98	q
9	2	6	MOREL Emma	FRA		0.66	29.23	<b>1:02.37</b> 33.14	2.82	R1
10	1	2	MARCHAND Juliette Marie	FRA		0.73	29.48	<b>1:02.43</b> 32.95	2.88	R2
11	2	7	PUJADAS RUSINOL Julia	ESP		0.68	29.56	<b>1:03.45</b> 33.89	3.90	
12	2	2	TACYILDIZ Defne	TUR		0.69	29.42	<b>1:03.99</b> 34.57	4.44	
13	1	7	MIDOUNI Lilia Sihem	ALG		0.72	30.17	<b>1:05.53</b> 35.36	5.98	

Issued: 04/07/2022 at 10:24





## Results

RANK	LANE	SURNAME & NAME	NOC	BORN	R.T.	50m	100m	150m	TIME	GAP	FINA PTS
------	------	----------------	-----	------	------	-----	------	------	------	-----	-------------

Event 7  
01/07/2022 - 19:03

### 200m Butterfly Women Final

WR	2:01.81	LIU Zige	CHI	2009
CR	2:06.89	CATERINA GIACCHETTI	ITA	2009

#### Final

1	4	PUDAR Lana	BIH	28.83	1:01.25 32.42	1:35.12 33.87	<b>2:09.18</b> 34.06	
2	5	MARTINS CUNHA MONTEIRO A	POR	29.09	1:01.74 32.65	1:35.44 33.70	<b>2:09.32</b> 33.88	0.14
3	3	TUNCEL Merve	TUR	30.19	1:04.06 33.87	1:38.42 34.36	<b>2:12.59</b> 34.17	3.41
4	8	PACHECO SE SOUSA ALMEIDA	POR	29.24	1:03.24 34.00	1:37.84 34.60	<b>2:12.73</b> 34.89	3.55
5	1	DAMASIOTI Georgia	GRE	29.57	1:03.34 33.77	1:37.82 34.48	<b>2:12.78</b> 34.96	3.60
6	2	MARCHAND Juliette Marie	FRA	30.05	1:03.79 33.74	1:38.31 34.52	<b>2:13.06</b> 34.75	3.88
7	6	GRANGEON Lara Marguerit	FRA	30.24	1:04.39 34.15	1:39.37 34.98	<b>2:14.27</b> 34.90	5.09
8	7	TACYILDIZ Defne	TUR	30.32	1:04.64 34.32	1:40.01 35.37	<b>2:16.22</b> 36.21	7.04

Issued: 01/07/2022 at 19:41



## Results

Event 7  
01/07/2022 - 11:05

### 200m Butterfly Women Preliminary

WR	2:01.81	LIU Zige	CHI	2009
CR	2:06.89	CATERINA GIACCHETTI	ITA	2009

#### Heat 1 of 2

RANK	LANE	SURNAME & NAME	NOC	BORN	R.T.	50m	100m	150m	TIME	GAP	FINA PTS
1	4	MARTINS CUNHA MONTEIRO A	POR		0.70	30.05	1:04.13 34.08	1:38.68 34.55	<b>2:13.37</b> 34.69		q
2	3	TUNCEL Merve	TUR		0.74	30.71	1:04.89 34.18	1:39.20 34.31	<b>2:13.54</b> 34.34	0.17	q
3	7	GRANGEON Lara Margueriit	FRA		0.71	30.57	1:04.53 33.96	1:39.53 35.00	<b>2:13.55</b> 34.02	0.18	q
4	6	DAMASIOTI Georgia	GRE		0.72	30.20	1:04.42 34.22	1:39.48 35.06	<b>2:14.36</b> 34.88	0.99	q
5	2	PUJADAS RUSINOL Julia	ESP		0.72	30.37	1:04.90 34.53	1:40.03 35.13	<b>2:15.51</b> 35.48	2.14	R2
6	1	BENCHADLI Jihane	ALG		0.80	30.54	1:06.20 35.66	1:45.53 39.33	<b>2:29.71</b> 44.18	16.34	

NOT CLASSIFIED

5		CUSINATO Ilaria	ITA						<b>DNS</b>		
---	--	-----------------	-----	--	--	--	--	--	------------	--	--

Issued: 01/07/2022 at 11:11

#### Heat 2 of 2

1	4	PUDAR Lana	BIH		0.88	29.32	1:03.13 33.81	1:37.82 34.69	<b>2:12.83</b> 35.01		q
2	6	MARCHAND Juliette Marie	FRA		0.78	30.69	1:05.05 34.36	1:39.74 34.69	<b>2:14.14</b> 34.40	1.31	q
3	5	TACYILDIZ Defne	TUR		0.75	31.11	1:04.90 33.79	1:39.24 34.34	<b>2:14.17</b> 34.93	1.34	q
4	2	PACHECO SE SOUSA ALMEIDA	POR		0.74	29.86	1:04.41 34.55	1:38.98 34.57	<b>2:14.38</b> 35.40	1.55	q
5	3	POLIERI Alessia	ITA		0.69	30.18	1:04.97 34.79	1:40.04 35.07	<b>2:14.53</b> 34.49	1.70	R1
6	7	HURTADO SIRERA Carla	ESP		0.72	30.87	1:05.38 34.51	1:41.34 35.96	<b>2:17.51</b> 36.17	4.68	
7	1	MITSAKOU Xanthi Panagiot	GRE		0.75	31.14	1:07.90 36.76	1:43.85 35.95	<b>2:20.29</b> 36.44	7.46	
8	8	MIDOUNI Lilia Sihem	ALG		0.76	31.27	1:06.89 35.62	1:45.88 38.99	<b>2:26.44</b> 40.56	13.61	

Issued: 01/07/2022 at 11:17



## Results

RANK HEAT LANE SURNAME & NAME NOC BORN R.T. 50m 100m 150m TIME GAP FINA PTS

### Event 7

01/07/2022 - 11:05

## 200m Butterfly Women Preliminary

WR CR	2:01.81 2:06.89	LIU Zige CATERINA GIACCHETTI	CHI ITA	2009 2009							
1	2	4	<b>PUDAR Lana</b>	BIH	0.88	29.32	1:03.13 33.81	1:37.82 34.69	<b>2:12.83</b> 35.01		q
2	1	4	<b>MARTINS CUNHA MONTEIRO A</b>	POR	0.70	30.05	1:04.13 34.08	1:38.68 34.55	<b>2:13.37</b> 34.69	0.54	q
3	1	3	<b>TUNCEL Merve</b>	TUR	0.74	30.71	1:04.89 34.18	1:39.20 34.31	<b>2:13.54</b> 34.34	0.71	q
4	1	7	<b>GRANGEON Lara Marguerit</b>	FRA	0.71	30.57	1:04.53 33.96	1:39.53 35.00	<b>2:13.55</b> 34.02	0.72	q
5	2	6	<b>MARCHAND Juliette Marie</b>	FRA	0.78	30.69	1:05.05 34.36	1:39.74 34.69	<b>2:14.14</b> 34.40	1.31	q
6	2	5	<b>TACYILDIZ Defne</b>	TUR	0.75	31.11	1:04.90 33.79	1:39.24 34.34	<b>2:14.17</b> 34.93	1.34	q
7	1	6	<b>DAMASIOTI Georgia</b>	GRE	0.72	30.20	1:04.42 34.22	1:39.48 35.06	<b>2:14.36</b> 34.88	1.53	q
8	2	2	<b>PACHECO SE SOUSA ALMEIDA</b>	POR	0.74	29.86	1:04.41 34.55	1:38.98 34.57	<b>2:14.38</b> 35.40	1.55	q
9	2	3	<b>POLIERI Alessia</b>	ITA	0.69	30.18	1:04.97 34.79	1:40.04 35.07	<b>2:14.53</b> 34.49	1.70	R1
10	1	2	<b>PUJADAS RUSINOL Julia</b>	ESP	0.72	30.37	1:04.90 34.53	1:40.03 35.13	<b>2:15.51</b> 35.48	2.68	R2
11	2	7	<b>HURTADO SIRERA Carla</b>	ESP	0.72	30.87	1:05.38 34.51	1:41.34 35.96	<b>2:17.51</b> 36.17	4.68	
12	2	1	<b>MITSAKOU Xanthi Panagiot</b>	GRE	0.75	31.14	1:07.90 36.76	1:43.85 35.95	<b>2:20.29</b> 36.44	7.46	
13	2	8	<b>MIDOUNI Lilia Sihem</b>	ALG	0.76	31.27	1:06.89 35.62	1:45.88 38.99	<b>2:26.44</b> 40.56	13.61	
14	1	1	<b>BENCHADLI Jihane</b>	ALG	0.80	30.54	1:06.20 35.66	1:45.53 39.33	<b>2:29.71</b> 44.18	16.88	
NOT CLASSIFIED											
	1	5	<b>CUSINATO Ilaria</b>	ITA					<b>DNS</b>		

Issued: 01/07/2022 at 11:17



# Swimming



## Results

RANK	LANE	SURNAME & NAME	NOC	BORN	R.T.	50m	100m	150m	TIME	GAP	FINA PTS
------	------	----------------	-----	------	------	-----	------	------	------	-----	-------------

### Event 27

04/07/2022 - 18:35

## 200m Individual Medley Women Final

WR	2:06.12	HOSSZU Katinka	HUN	2015
CR	2:10.36	CAMILLE MUFFAT	FRA	2009
JR	2:09.57	YU YITING	CHN	2021

### Final

1	5	FRANCESCHI Sara	ITA	0.71	28.82	1:02.46 33.64	1:40.75 38.29	<b>2:12.19</b> 31.44	
2	4	GUNES Viktoria	TUR	0.67	28.91	1:03.04 34.13	1:39.50 36.46	<b>2:12.26</b> 32.76	0.07
3	3	ERTAN Deniz	TUR	0.68	28.96	1:05.10 36.14	1:43.08 37.98	<b>2:14.15</b> 31.07	1.96
4	7	JUSTE SANCHEZ Paula	ESP	0.64	29.13	1:03.99 34.86	1:44.14 40.15	<b>2:15.94</b> 31.80	3.75
5	1	VAZQUEZ RUIZ Alba	ESP	0.73	29.78	1:05.92 36.14	1:44.69 38.77	<b>2:16.50</b> 31.81	4.31
6	6	TISSANDIE Camille Amelie	FRA	0.68	29.24	1:04.88 35.64	1:45.21 40.33	<b>2:17.57</b> 32.36	5.38
7	2	SACHA Ioanna	GRE	0.72	29.86	1:04.77 34.91	1:45.20 40.43	<b>2:19.65</b> 34.45	7.46
8	8	NEFSI Hamida Rania	ALG	0.75	30.31	1:07.72 37.41	1:48.94 41.22	<b>2:22.77</b> 33.83	10.58

Issued: 04/07/2022 at 18:46

# Swimming



## Results

RANK	LANE	SURNAME & NAME	NOC	BORN	R.T.	50m	100m	150m	TIME	GAP	FINA PTS
------	------	----------------	-----	------	------	-----	------	------	------	-----	-------------

### Event 27

04/07/2022 - 10:30

## 200m Individual Medley Women Preliminary

WR	2:06.12	HOSSZU Katinka	HUN	2015
CR	2:10.36	CAMILLE MUFFAT	FRA	2009
JR	2:09.57	YU YITING		2021

### Heat 1 of 2

1	4	GUNES Viktoria	TUR	0.69	29.77	1:05.65 35.88	1:43.06 37.41	<b>2:17.09</b> 34.03		q
2	5	TISSANDIE Camille Amelie	FRA	0.70	29.85	1:05.57 35.72	1:46.08 40.51	<b>2:18.19</b> 32.11	1.10	q
3	6	SACHA Ioanna	GRE	0.72	30.34	1:04.37 34.03	1:45.30 40.93	<b>2:18.93</b> 33.63	1.84	q
4	3	JUSTE SANCHEZ Paula	ESP	0.66	29.61	1:04.85 35.24	1:45.94 41.09	<b>2:19.09</b> 33.15	2.00	q
5	2	BENCHADLI Jihane	ALG	0.78	30.56	1:06.82 36.26	1:49.68 42.86	<b>2:24.24</b> 34.56	7.15	R1

Issued: 04/07/2022 at 10:29

### Heat 2 of 2

1	4	FRANCESCHI Sara	ITA	0.70	29.16	1:03.95 34.79	1:43.20 39.25	<b>2:17.41</b> 34.21		q
2	6	ERTAN Deniz	TUR	0.72	29.46	1:06.13 36.67	1:45.74 39.61	<b>2:17.93</b> 32.19	0.52	q
3	5	VAZQUEZ RUIZ Alba	ESP	0.74	30.35	1:06.99 36.64	1:47.06 40.07	<b>2:20.44</b> 33.38	3.03	q
4	2	NEFSI Hamida Rania	ALG	0.73	30.55	1:08.50 37.95	1:48.90 40.40	<b>2:22.71</b> 33.81	5.30	q

NOT CLASSIFIED

3		CUSINATO Ilaria	ITA					<b>DNS</b>		
---	--	-----------------	-----	--	--	--	--	------------	--	--

Issued: 04/07/2022 at 10:35

# Swimming



## Results

RANK HEAT LANE SURNAME & NAME NOC BORN R.T. 50m 100m 150m TIME GAP FINA PTS

### Event 27

04/07/2022 - 10:30

## 200m Individual Medley Women Preliminary

WR	2:06.12	HOSSZU Katinka	HUN	2015
CR	2:10.36	CAMILLE MUFFAT	FRA	2009
JR	2:09.57	YU YITING		2021

RANK	HEAT	LANE	SURNAME & NAME	NOC	BORN	R.T.	50m	100m	150m	TIME	GAP	FINA PTS
1	1	4	GUNES Viktoria	TUR		0.69	29.77	1:05.65 35.88	1:43.06 37.41	<b>2:17.09</b> 34.03		q
2	2	4	FRANCESCHI Sara	ITA		0.70	29.16	1:03.95 34.79	1:43.20 39.25	<b>2:17.41</b> 34.21	0.32	q
3	2	6	ERTAN Deniz	TUR		0.72	29.46	1:06.13 36.67	1:45.74 39.61	<b>2:17.93</b> 32.19	0.84	q
4	1	5	TISSANDIE Camille Amelie	FRA		0.70	29.85	1:05.57 35.72	1:46.08 40.51	<b>2:18.19</b> 32.11	1.10	q
5	1	6	SACHA Ioanna	GRE		0.72	30.34	1:04.37 34.03	1:45.30 40.93	<b>2:18.93</b> 33.63	1.84	q
6	1	3	JUSTE SANCHEZ Paula	ESP		0.66	29.61	1:04.85 35.24	1:45.94 41.09	<b>2:19.09</b> 33.15	2.00	q
7	2	5	VAZQUEZ RUIZ Alba	ESP		0.74	30.35	1:06.99 36.64	1:47.06 40.07	<b>2:20.44</b> 33.38	3.35	q
8	2	2	NEFSI Hamida Rania	ALG		0.73	30.55	1:08.50 37.95	1:48.90 40.40	<b>2:22.71</b> 33.81	5.62	q
9	1	2	BENCHADLI Jihane	ALG		0.78	30.56	1:06.82 36.26	1:49.68 42.86	<b>2:24.24</b> 34.56	7.15	R1

NOT CLASSIFIED

2	3	CUSINATO Ilaria	ITA							DNS		
---	---	-----------------	-----	--	--	--	--	--	--	-----	--	--

Issued: 04/07/2022 at 10:35



# Swimming



## Results

RANK	LANE	SURNAME & NAME			NOC	BORN			R.T.	TIME	GAP	FINA PTS
	50m	100m	150m	200m	250m	300m	350m					

### Event 3

01/07/2022 - 18:18

## 400m Individual Medley Women Final

WR	4:26.36	HOSSZU Katinka		HUN		2016
CR	4:39.42	LORENTE CATALINA		ESP		2018

### Final

1	5	<b>FRANCESCHI Sara</b>	ITA		0.75	<b>4:40.86</b>		
	29.94(3)	1:03.99(2) 34.05	1:40.12(1) 36.13	2:15.40(1) 35.28	2:55.79(1) 40.39	3:36.08(1) 40.29	4:09.33(1) 33.25	31.53
2	4	<b>ERTAN Deniz</b>	TUR		0.69	<b>4:40.97</b>	0.11	
	29.81(1)	1:03.02(1) 33.21	1:40.95(2) 37.93	2:17.97(2) 37.02	2:57.27(2) 39.30	3:37.30(2) 40.03	4:10.25(2) 32.95	30.72
3	3	<b>VAZQUEZ RUIZ Alba</b>	ESP		0.75	<b>4:45.63</b>	4.77	
	30.48(5)	1:04.75(5) 34.27	1:42.58(5) 37.83	2:20.14(4) 37.56	2:59.35(4) 39.21	3:39.48(3) 40.13	4:13.44(3) 33.96	32.19
4	2	<b>GUNES Viktoria Z.</b>	TUR		0.72	<b>4:46.30</b>	5.44	
	29.95(4)	1:04.07(3) 34.12	1:42.55(4) 38.48	2:20.27(5) 37.72	2:59.01(3) 38.74	3:39.57(4) 40.56	4:14.33(4) 34.76	31.97
5	6	<b>GOMES RAMOS PEREIRA Raqu</b>	POR		0.78	<b>4:48.92</b>	8.06	
	30.77(8)	1:05.87(6) 35.10	1:45.37(8) 39.50	2:23.32(8) 37.95	3:02.54(6) 39.22	3:42.32(5) 39.78	4:16.47(5) 34.15	32.45
6	1	<b>JUSTE SANCHEZ Paula</b>	ESP		0.66	<b>4:52.16</b>	11.30	
	29.84(2)	1:04.39(4) 34.55	1:42.26(3) 37.87	2:19.31(3) 37.05	3:01.68(5) 42.37	3:45.11(6) 43.43	4:18.69(6) 33.58	33.47
7	8	<b>TISSANDIE Camille Amelie</b>	FRA		0.70	<b>4:52.18</b>	11.32	
	30.62(6)	1:06.22(7) 35.60	1:44.86(7) 38.64	2:23.17(7) 38.31	3:04.58(8) 41.41	3:45.82(7) 41.24	4:19.42(7) 33.60	32.76
8	7	<b>TONI Carlotta</b>	ITA		0.74	<b>4:54.80</b>	13.94	
	30.72(7)	1:06.67(8) 35.95	1:44.33(6) 37.66	2:21.66(6) 37.33	3:03.50(7) 41.84	3:45.87(8) 42.37	4:20.58(8) 34.71	34.22

Issued: 01/07/2022 at 19:46



# Swimming



## Results

RANK	LANE	SURNAME & NAME			NOC	BORN			R.T.	TIME	GAP	FINA	PTS
		50m	100m	150m	200m	250m	300m	350m					

Event 3  
01/07/2022 - 10:20

### 400m Individual Medley Women Preliminary

WR	4:26.36	HOSSZU Katinka		HUN		2016
CR	4:39.42	LORENTE CATALINA		ESP		2018

#### Heat 1 of 2

1	4	<b>ERTAN Deniz</b>	TUR	0.74	<b>4:46.28</b>	q
		29.92(1) 1:03.48(1) 33.56 38.54	2:19.88(1) 37.86 39.49	3:39.78(1) 40.41	4:13.84(1) 34.06 32.44	
2	6	<b>GUNES Viktoria Z.</b>	TUR	0.73	<b>4:51.67</b>	5.39 q
		30.65(2) 1:05.39(2) 34.74 38.84	2:21.89(3) 37.66 40.23	3:43.45(2) 41.33	4:18.50(2) 35.05 33.17	
3	5	<b>TONI Carlotta</b>	ITA	0.75	<b>4:51.99</b>	5.71 q
		30.82(5) 1:06.35(5) 35.53 37.63	2:21.25(2) 37.27 41.67	3:44.77(3) 41.85	4:18.96(3) 34.19 33.03	
4	3	<b>TISSANDIE Camille Amelie</b>	FRA	0.79	<b>4:54.84</b>	8.56 R1
		30.69(4) 1:06.33(4) 35.64 39.05	2:24.29(5) 38.91 41.51	3:47.72(4) 41.92	4:21.53(4) 33.81 33.31	
5	7	<b>ZITOUNI Imene Kawthar</b>	ALG	0.68	<b>5:04.81</b>	18.53
		31.43(6) 1:07.06(6) 35.63 39.29	2:23.62(4) 37.27 45.51	3:09.13(5) 45.06	4:30.48(5) 36.29 34.33	
6	2	<b>MITSAKOU Chrysoula</b>	GRE	0.71	<b>5:07.27</b>	20.99
		30.67(3) 1:06.16(3) 35.49 39.49	2:25.88(6) 40.23 45.55	3:11.43(6) 47.60	4:33.11(6) 34.08 34.16	

Issued: 01/07/2022 at 10:29

#### Heat 2 of 2

1	4	<b>FRANCESCHI Sara</b>	ITA	0.76	<b>4:46.75</b>	q
		29.95(1) 1:04.26(1) 34.31 36.30	2:16.69(1) 36.13 40.49	3:38.71(1) 41.53	4:13.62(1) 34.91 33.13	
2	5	<b>VAZQUEZ RUIZ Alba</b>	ESP	0.77	<b>4:49.60</b>	2.85 q
		31.61(5) 1:05.86(3) 34.25 39.08	2:22.69(4) 37.75 39.96	3:42.79(2) 40.14	4:17.08(2) 34.29 32.52	
3	2	<b>GOMES RAMOS PEREIRA Raqu</b>	POR	0.78	<b>4:50.36</b>	3.61 q
		30.55(3) 1:06.44(5) 35.89 39.68	2:25.34(5) 39.22 38.53	3:03.87(5) 40.13	4:17.86(4) 33.86 32.50	
4	3	<b>GRANGEON Lara Marguerit</b>	FRA	0.75	<b>4:50.47</b>	3.72 q
		30.90(4) 1:05.98(4) 35.08 37.63	2:20.78(3) 37.17 40.16	3:42.82(3) 41.88	4:17.74(3) 34.92 32.73	
5	6	<b>JUSTE SANCHEZ Paula</b>	ESP	0.69	<b>4:53.58</b>	6.83 q
		30.39(2) 1:04.81(2) 34.42 37.78	2:19.53(2) 36.94 42.60	3:02.13(3) 43.37	4:19.99(5) 34.49 33.59	
6	7	<b>NEFSI Hamida Rania</b>	ALG	0.80	<b>5:01.05</b>	14.30 R2
		31.72(6) 1:08.23(6) 36.51 39.89	2:26.63(6) 38.51 42.40	3:09.03(6) 42.35	4:26.75(6) 35.37 34.30	

Issued: 01/07/2022 at 10:34





# Swimming



## Results

RANK	HEAT	LANE	SURNAME & NAME			NOC	BORN			R.T.	TIME	GAP	FINA	PTS
		50m	100m	150m	200m	250m	300m	350m						

### Event 3

01/07/2022 - 10:20

## 400m Individual Medley Women Preliminary

<b>WR</b>	<b>4:26.36</b>	<b>HOSSZU Katinka</b>	<b>HUN</b>	<b>2016</b>
<b>CR</b>	<b>4:39.42</b>	<b>LORENTE CATALINA</b>	<b>ESP</b>	<b>2018</b>

1	1	4	<b>ERTAN Deniz</b>	TUR	0.74	<b>4:46.28</b>		q
		29.92	1:03.48	1:42.02	2:19.88	2:59.37	3:39.78	4:13.84
			33.56	38.54	37.86	39.49	40.41	34.06
								32.44
2	2	4	<b>FRANCESCHI Sara</b>	ITA	0.76	<b>4:46.75</b>	0.47	q
		29.95	1:04.26	1:40.56	2:16.69	2:57.18	3:38.71	4:13.62
			34.31	36.30	36.13	40.49	41.53	34.91
								33.13
3	2	5	<b>VAZQUEZ RUIZ Alba</b>	ESP	0.77	<b>4:49.60</b>	3.32	q
		31.61	1:05.86	1:44.94	2:22.69	3:02.65	3:42.79	4:17.08
			34.25	39.08	37.75	39.96	40.14	34.29
								32.52
4	2	2	<b>GOMES RAMOS PEREIRA Raqu</b>	POR	0.78	<b>4:50.36</b>	4.08	q
		30.55	1:06.44	1:46.12	2:25.34	3:03.87	3:44.00	4:17.86
			35.89	39.68	39.22	38.53	40.13	33.86
								32.50
5	2	3	<b>GRANGEON Lara Marguerit</b>	FRA	0.75	<b>4:50.47</b>	4.19	q
		30.90	1:05.98	1:43.61	2:20.78	3:00.94	3:42.82	4:17.74
			35.08	37.63	37.17	40.16	41.88	34.92
								32.73
6	1	6	<b>GUNES Viktoria Z.</b>	TUR	0.73	<b>4:51.67</b>	5.39	q
		30.65	1:05.39	1:44.23	2:21.89	3:02.12	3:43.45	4:18.50
			34.74	38.84	37.66	40.23	41.33	35.05
								33.17
7	1	5	<b>TONI Carlotta</b>	ITA	0.75	<b>4:51.99</b>	5.71	q
		30.82	1:06.35	1:43.98	2:21.25	3:02.92	3:44.77	4:18.96
			35.53	37.63	37.27	41.67	41.85	34.19
								33.03
8	2	6	<b>JUSTE SANCHEZ Paula</b>	ESP	0.69	<b>4:53.58</b>	7.30	q
		30.39	1:04.81	1:42.59	2:19.53	3:02.13	3:45.50	4:19.99
			34.42	37.78	36.94	42.60	43.37	34.49
								33.59
9	1	3	<b>TISSANDIE Camille Amelie</b>	FRA	0.79	<b>4:54.84</b>	8.56	R1
		30.69	1:06.33	1:45.38	2:24.29	3:05.80	3:47.72	4:21.53
			35.64	39.05	38.91	41.51	41.92	33.81
								33.31
10	2	7	<b>NEFSI Hamida Rania</b>	ALG	0.80	<b>5:01.05</b>	14.77	R2
		31.72	1:08.23	1:48.12	2:26.63	3:09.03	3:51.38	4:26.75
			36.51	39.89	38.51	42.40	42.35	35.37
								34.30
11	1	7	<b>ZITOUNI Imene Kawthar</b>	ALG	0.68	<b>5:04.81</b>	18.53	
		31.43	1:07.06	1:46.35	2:23.62	3:09.13	3:54.19	4:30.48
			35.63	39.29	37.27	45.51	45.06	36.29
								34.33
12	1	2	<b>MITSAKOU Chrysoula</b>	GRE	0.71	<b>5:07.27</b>	20.99	
		30.67	1:06.16	1:45.65	2:25.88	3:11.43	3:59.03	4:33.11
			35.49	39.49	40.23	45.55	47.60	34.08
								34.16

Issued: 01/07/2022 at 10:34

# Swimming



## Results

RANK	LANE	NOC	RELAY	BORN	R.T.	50m	TIME	GAP	FINA	PTS
			SURNAME & NAME							

Event 38

05/07/2022 - 19:34

### 4 x 100m Freestyle Women Final

WR	3:29.69	AUSTRALIA	AUS	2021
CR	3:39.95	ITALY	ITA	2018
JR	3:36.19	CANADA	CAN	2017

### Final

RANK	LANE	NOC	RELAY	BORN	R.T.	50m	TIME	GAP	FINA	PTS
1	7	<b>SLO SLOVENIA</b>					<b>3:38.52</b>			CR
		SEGEL Janja		0.73	26.19	54.26	26.19			
		KLANCAR Neza		0.22	26.04	54.07	1:20.30			
		FAIN Katja		0.33	26.55	54.82	2:14.88			
		PINTAR Tjasa		0.31	26.50	55.37	3:09.65			
2	3	<b>FRA FRANCE</b>					<b>3:41.57</b>	3.05		
		TOUATI Assia Anais Nouri		0.67	27.11	56.14	27.11			
		TESSARIOL Lucile Lora		0.48	26.28	54.63	1:22.42			
		JEHL Marina		0.24	26.36	55.11	2:17.13			
		CARNEZ Oceane Delphine		0.40	26.11	55.69	3:11.99			
3	4	<b>ITA ITALY</b>					<b>3:42.86</b>	4.34		
		LAQUINTANA Sonia		0.71	26.61	56.14	26.61			
		MIZZAU Alice		0.36	27.00	56.04	1:23.14			
		SCOTTO DI CARLO Viola		0.33	26.34	55.67	2:18.52			
		MORINI Sofia		0.22	26.03	55.01	3:13.88			
4	5	<b>ESP SPAIN</b>					<b>3:44.00</b>	5.48		
		CAMPABADAL Ainhoa		0.72	27.02	56.88	27.02			
		MUNOZ DEL CAMPO Lidon		0.16	25.73	54.79	1:22.61			
		WEILER SASTRE Carmen		0.15	26.61	55.91	2:18.28			
		ZAMORANO SANZ Africa		0.15	26.92	56.42	3:14.50			
5	6	<b>TUR TURKIYE</b>					<b>3:49.39</b>	10.87		
		ELIGUL Sezin		0.64	27.64	58.18	27.64			
		CAKICI I.Nihan		0.09	27.04	56.73	1:25.22			
		GUNES Viktoria		0.42	27.54	56.87	2:22.45			
		AVRAMOVA Ekaterina		0.28	28.00	57.61	3:19.78			
6	2	<b>GRE GREECE</b>					<b>3:50.56</b>	12.04		
		KLIKOPOULOU Sofia		0.66	27.30	57.47	27.30			
		MITSAKOU Chrysoula		0.30	27.72	57.70	1:25.19			
		MITSAKOU Xanthi		0.02	27.49	58.19	2:22.66			
		NTOUNTOUNAKI Anna		0.33	27.38	57.20	3:20.74			
7	8	<b>POR PORTUGAL</b>					<b>3:51.23</b>	12.71		
		SOARES MARTINS Francisca		0.69	27.84	58.01	27.84			
		DE PINHO RODRIGUES Ana		0.20	27.21	57.55	1:25.22			
		PACHECO DE SOUSA Mariana		0.43	26.78	56.88	2:22.34			
		RODRIGUES REBELO Camila		0.26	28.42	58.79	3:20.86			
8	1	<b>ALG ALGERIA</b>					<b>3:53.20</b>	14.68		
		MELIH Amel		0.66	27.00	56.68	27.00			
		MEDJAHED Nesrine		0.08	26.71	57.18	1:23.39			
		BENCHADLI Jihane		0.22	28.08	1:00.25	2:21.94			
		MIDOUNI Lilia Sihem		0.33	28.13	59.09	3:22.24			

Issued: 05/07/2022 at 19:39



# Swimming



## Results

RANK	LANE	NOC	RELAY	BORN	R.T.	50m	100m	200m	300m	TIME	GAP	FINA	PTS
			SURNAME & NAME										

Event 22  
03/07/2022 - 19:28

### 4 x 200m Freestyle Women

WR	7:40.33	CHINA	CHN	2021
CR	7:56.69	ITALY	ITA	2009
JR	7:51.47	CANADA	CAN	2017

### FINAL

1	6	<b>SLO SLOVENIA</b>								<b>7:59.27</b>			
		SEGEL Janja	0.75	28.00	58.03	1:28.72	1:59.34	1:59.34					
		KLANCAR Neza	0.44	27.74	58.24	1:29.76	2:02.07	4:01.41					
		FAIN Katja	0.23	27.17	57.51	1:28.01	1:57.72	5:59.13					
		PINTAR Tjasa	0.32	28.35	59.04	1:29.85	2:00.14	7:59.27					
2	4	<b>ITA ITALY</b>								<b>7:59.63</b>	0.36		
		CAPONI Linda	0.76	28.54	59.01	1:29.88	2:00.51	2:00.51					
		CESARANO Antonietta	0.26	28.20	58.41	1:28.97	1:59.16	3:59.67					
		CESARANO Noemi	0.23	28.21	58.61	1:29.79	2:00.65	6:00.32					
		MIZZAU Alice	0.35	27.43	57.63	1:28.60	1:59.31	7:59.63					
3	5	<b>TUR TURKIYE</b>								<b>8:05.41</b>	6.14		
		ERTAN Deniz	0.68	28.55	59.22	1:30.32	2:01.42	2:01.42					
		TUNCEL Merve	0.32	28.50	59.13	1:30.01	2:00.63	4:02.05					
		DONMEZ Ecem	0.38	28.49	59.17	1:29.96	2:01.13	6:03.18					
		BOCEKLER Beril	0.20	28.39	59.25	1:31.04	2:02.23	8:05.41					
4	1	<b>FRA FRANCE</b>								<b>8:07.34</b>	8.07		
		CARNEZ Oceane Delphine	0.64	28.47	58.89	1:29.73	2:00.78	2:00.78					
		TESSARIOL Lucile Lora	0.26	27.80	58.15	1:29.10	1:59.44	4:00.22					
		JEHL Marina	0.33	28.46	59.32	1:31.85	2:04.10	6:04.32					
		TOUATI Assia Anais Nouri	0.19	27.59	58.21	1:30.19	2:03.02	8:07.34					
5	2	<b>ESP SPAIN</b>								<b>8:10.08</b>	10.81		
		CAMPABADAL Ainhoa	0.71	28.80	59.58	1:30.61	2:02.09	2:02.09					
		JUSTE SANCHEZ Paula	0.22	28.23	59.14	1:30.46	2:02.52	4:04.61					
		ZAMORANO SANZ Africa	0.24	28.05	59.28	1:31.00	2:02.32	6:06.93					
		PUJADAS RUSINOL Julia	0.24	28.12	59.53	1:31.72	2:03.15	8:10.08					
6	7	<b>POR PORTUGAL</b>								<b>8:17.52</b>	18.25		
		SOARES MARTINS Francisca	0.67	28.45	58.94	1:30.44	2:01.82	2:01.82					
		HOLUB Tamila Hryhorivna	0.14	27.52	58.44	1:30.91	2:04.00	4:05.82					
		PACHECO DE SOUSA Mariana	0.45	27.58	58.88	1:31.71	2:05.70	6:11.52					
		RODRIGUES REBELO Camila	0.36	28.61	1:00.37	1:33.17	2:06.00	8:17.52					

Issued: 03/07/2022 at 19:56



# Swimming



## Results

RANK	LANE	NOC	RELAY	SURNAME & NAME	BORN	R.T.	50m	TIME	GAP	FINA	PTS
------	------	-----	-------	----------------	------	------	-----	------	-----	------	-----

### Event 29

04/07/2022 - 18:53

## 4 x 100m Medley Women Final

WR	3:50.40	USA	USA	2019
CR	3:58.27	ITALY	ITA	2018
JR	3:58.38	CANADA	CAN	2017

### FINAL

1	6	<b>ITA ITALY</b>						<b>4:04.65</b>		
		ZOFKOVA COSTA Carlotta	0.71	29.94	1:01.52	29.94				
		ANGIOLINI Lisa	0.41	22.90	1:07.32	1:24.42				
		BIANCHI Ilaria	0.25	27.73	1:00.78	2:36.57				
		MORINI Sofia	0.33	26.15	55.03	3:35.77				
2	3	<b>ESP SPAIN</b>						<b>4:06.17</b>	1.52	
		ZAMORANO SANZ Africa	0.58	30.23	1:02.24	30.23				
		GARCIA URZAINQUI Marina	0.21	31.93	1:08.63	1:34.17				
		HURTADO SIRERA Carla	0.23	28.28	1:01.05	2:39.15				
		MUNOZ DEL CAMPO Lidon	0.22	25.67	54.25	3:37.59				
3	4	<b>TUR TURKIYE</b>						<b>4:07.31</b>	2.66	
		AVRAMOVA Ekaterina	0.60	30.38	1:01.69	30.38				
		GUNES Viktoria	0.25	32.45	1:08.66	1:34.14				
		ERTAN Deniz	0.52	28.62	1:00.56	2:38.97				
		CAKICI I.Nihan		56.40	56.40	4:07.31				
4	1	<b>POR PORTUGAL</b>						<b>4:07.57</b>	2.92	
		RODRIGUES REBELO Camila	0.60	29.82	1:02.02	29.82				
		DE PINHO RODRIGUES Ana	0.12	31.47	1:09.38	1:33.49				
		PACHECO DE SOUSA Mariana	0.50	27.77	59.60	2:39.17				
		SOARES MARTINS Francisca	0.23	27.01	56.57	3:38.01				
5	2	<b>SLO SLOVENIA</b>						<b>4:08.51</b>	3.86	
		SEGEL Janja	0.66	30.08	1:02.50	30.08				
		VOVK Tara	0.19	31.29	1:10.20	1:33.79				
		PINTAR Tjasa	0.22	28.07	1:00.71	2:40.77				
		KLANCAR Neza	0.27	26.15	55.10	3:39.56				
6	5	<b>GRE GREECE</b>						<b>4:09.96</b>	5.31	
		SACHA Ioanna	0.59	30.93	1:04.10	30.93				
		ANGELAKI Chara	0.01	32.26	1:10.02	1:36.36				
		NTOUNTOUNAKI Anna	0.29	27.14	58.97	2:41.26				
		KLIKOPOULOU Sofia	0.20	26.71	56.87	3:39.80				
7	7	<b>ALG ALGERIA</b>						<b>4:20.78</b>	16.13	
		ZITOUNI Imene Kawthar	0.53	31.86	1:06.68	31.86				
		NEFSI Hamida Rania	0.44	28.46	1:14.50	1:35.14				
		MEDJAHED Nesrine	0.11	28.78	1:03.29	2:49.96				
		MELIH Amel	0.21	26.51	56.31	3:50.98				

Issued: 04/07/2022 at 19:15

# Swimming



## Records Broken by event

EVENT		SURNAME & NAME	NOC	BORN	TIME	TYPE
100m Freestyle Women	Final	<b>ANTONIOU Kalia</b>	CYP		<b>54.36</b>	CR
200m Freestyle Women	Final	<b>SEGEL Janja</b>	SLO		<b>1:56.68</b>	CR
50m Breaststroke Women	Final	<b>ANGIOLINI Lisa</b>	ITA		<b>30.87</b>	CR
100m Butterfly Women	Final	<b>PUDAR Lana</b>	BIH		<b>57.55</b>	CR
4 x 100m Freestyle Women	Final	<b>SLOVENIA</b>	SLO		<b>3:38.52</b>	CR
50m Breaststroke Men	Heat 2 of 3	<b>SCOZZOLI Fabio</b>	ITA		<b>27.17</b>	CR
	Final	<b>SCOZZOLI Fabio</b>	ITA		<b>26.97</b>	CR
100m Breaststroke Men	Final	<b>OGRETIR Berkay O.</b>	TUR		<b>1:00.03</b>	CR
50m Butterfly Men	Final	<b>DE MATOS RIBEIRO Diogo</b>	POR		<b>23.38</b>	CR
100m Butterfly Men	Final	<b>RIVOLTA Matteo</b>	ITA		<b>51.66</b>	CR



ألعاب البحر الأبيض المتوسط  
MEDITERRANEAN GAMES  
JEUX MÉDITERRANÉENS  
du 25 juin au 06 juillet

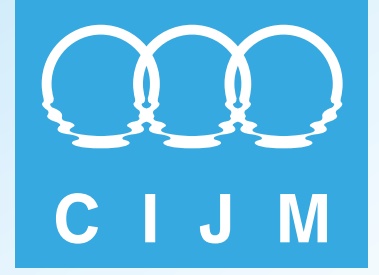

# Results Book



## Tennis



**TOSYALI  
ALGERIE**

Fer et Acier

سوناطراي



sonarach



microplus  
DATA PROCESSING & TIMING  
[www.microplustiming.com](http://www.microplustiming.com)



## Medallists by event

As of SAT 2 JUL 2022 at 15:58

After 4 of 4 events

Event Name	Date	Medal	Name	CTRY Code
Women Single	FRI 1 JUL 2022	GOLD	MARISTANY ZULETA Guiomar	ESP
		SILVER	BRANCACCIO Nuria	ITA
		BRONZE	BOUZAS MANEIRO Jessica	ESP
Men Single	FRI 1 JUL 2022	GOLD	PASSARO Francesco	ITA
		SILVER	MONTAGUD Carlos Lopez	ESP
		BRONZE	MOUNDIR Adam Ralph Khalifa	MAR
Women Double	THU 30 JUN 2022	GOLD	BOUZAS MANEIRO Jessica MARISTANY ZULETA Guiomar	ESP
		SILVER	CURMI Francesca GENOVESE Elaine	MLT
		BRONZE	BRANCACCIO Nuria ZANTEDESCHI Aurora	ITA
Men Double	THU 30 JUN 2022	GOLD	ARNALDI Matteo PASSARO Francesco	ITA
		SILVER	MONTAGUD Carlos Lopez SAN MARTIN Alvaro L.	ESP
		BRONZE	BENCHETRIT Elliot Joseph Jean MOUNDIR Adam Ralph Khalifa	MAR



## Medal Standings

As of SAT 2 JUL 2022 at 15:05

After 4 of 4 events

Rank	Country	Men				Women				Total				Rank by total
		G	S	B	Tot	G	S	B	Tot	G	S	B	Tot	
1	ESP - Spain		2		2	2		1	3	2	2	1	5	1
2	ITA - Italy	2			2		1	1	2	2	1	1	4	2
3	MLT - Malta						1		1		1		1	4
4	MAR - Morocco			2	2							2	2	3
<b>Total:</b>		<b>2</b>	<b>2</b>	<b>2</b>	<b>6</b>	<b>2</b>	<b>2</b>	<b>2</b>	<b>6</b>	<b>4</b>	<b>4</b>	<b>4</b>	<b>12</b>	

### LEGEND

= Equal indicates the same rank  
Tot Total

B Bronze

G Gold

S Silver





## Medal Standings

As of THU 30 JUN 2022 at 19:40

After 2 of 4 events

Rank	Country	Men				Women				Total				Rank by total
		G	S	B	Tot	G	S	B	Tot	G	S	B	Tot	
1	ESP - Spain		1		1	1			1	1	1		2	= 1
2	ITA - Italy	1			1			1	1	1		1	2	= 1
3	MLT - Malta						1		1		1		1	= 3
4	MAR - Morocco			1	1							1	1	= 3
<b>Total:</b>		<b>1</b>	<b>1</b>	<b>1</b>	<b>3</b>	<b>1</b>	<b>1</b>	<b>1</b>	<b>3</b>	<b>2</b>	<b>2</b>	<b>2</b>	<b>6</b>	

### LEGEND

= Equal indicates the same rank  
Tot Total

B Bronze

G Gold

S Silver



## Daily Match Information - Results Summary

As of SAT 2 JUL 2022 at 15:41

27 JUN 2022

Event	Round	Name		Name	Results
<u>C.Court</u>					
S	R32	MAAMOUN Karim Mohamed (EGY)	d.	SAHTALI Toufk (ALG)	6 - 3, 7 - 6(1)
S	R32	KIRCI Koroy (TUR)	d.	RIHANE Youcef (ALG)	6 - 3, 6 - 2
D	R16	BEKRAR / IBBOU (ALG)	d.	ALVES CAMPINO / FONTE (POR)	6 - 3, 6 - 2
<u>Court 1</u>					
S	R32	BENAISSA Amira (ALG)	d.	FONTE Maria Inês (POR)	5 - 7, 7 - 6(2), 6 - 4
D	R16	CHRYSOCHOS / NEOS (CYP)	d.	SKORILAS / THANOS (GRE)	3 - 0
<u>Court 2</u>					
S	R32	ALVES CAMPINO Mariana (POR)	d.	BEN HASSEN Feryel (TUN)	6 - 2, 6(6) - 7, 6 - 1
S	R32	OUAKAA Mohamed Aziz (TUN)	d.	TASHI Vullnet (KOS)	6 - 3, 6 - 2
D	R16	AGABIGUN / ILKEL (TUR)	d.	COSTA COELHO / GOMES (POR)	7 - 5, 6 - 2
<u>Court 3</u>					
S	R32	MOUNDIR Adam Ralph Khalifa (MAR)	d.	GOMES Miguel (POR)	6 - 4, 6 - 1
S	R32	BECHRI Chiraz (TUN)	d.	DULE Kristal (ALB)	6 - 1, 6 - 1
S	R32	CHRYSOCHOS Petros (CYP)	d.	COSTA COELHO Fabio Alexandre (POR)	6(3) - 4, 7 - 5, 0 - 0
D	R16	DOMINKO / PREMZL (SLO)	d.	HAMZA REGUIG / RITHANE (ALG)	3 - 6, 6 - 4, [10] - [8]
<u>Court 4</u>					
S	R32	EREL Yanki (TUR)	d.	DOMINKO Sebastian (SLO)	6(3) - 7, 6 - 4, 6 - 4
S	R32	MONTAGUD Carlos Lopez (ESP)	d.	MUEDINI Martin (ALB)	6 - 0, 6 - 1
D	R16	ELSAYED / MAAMOUN (EGY)	d.	ASCIK / DE GABRIELE (MLT)	6 - 2, 7 - 5
<u>Court 5</u>					
S	R32	ELSAYED Amr (EGY)	d.	DE ROSSI Marco (SMR)	6 - 3, 6 - 4
S	R32	EFSTATHIOU Menelaos (CYP)	d.	ABDERRAHMAN Wissam (TUN)	6 - 2, 6 - 0
S	R32	EL AOUNI Aya (MAR)	d.	CURMI Francesca (MLT)	3 - 6, 7 - 6(4), 7 - 6(5)
<u>Court 6</u>					
S	R32	DELICATA Liam (MLT)	d.	THANOS Aristotelis (GRE)	0 - 0
S	R32	SAN MARTIN Alvaro L. (ESP)	d.	PREMZL Maj (SLO)	6 - 4, 6 - 4
<u>Court 7</u>					
S	R32	ASCIK Matthew (MLT)	d.	SKORILAS Alexandros (GRE)	6 - 1, 3 - 6, 7 - 6(3)
S	R32	PELLICANO Helene (MLT)	d.	EL SAYED Aya (EGY)	4 - 6, 6 - 1, 7 - 5



## Daily Match Information - Results Summary

As of SAT 2 JUL 2022 at 15:41

28 JUN 2022

Event	Round	Name		Name	Results
<u>C.Court</u>					
S	R16	KABBAJ Yasmine (MAR)	d.	IBBOU Ines Feriel (ALG)	6 - 2, 6 - 4
S	R16	MARISTANY ZULETA Guiomar (ESP)	d.	BENAÏSSA Amira (ALG)	6 - 2, 6 - 2
S	R16	CATARINA Lucas (MON)	d.	EFSTATHIOU Menelaos (CYP)	6 - 3, 7 - 5
D	QF	BOUZAS MANEIRO / MARISTANY ZULETA (	d.	BEKRAR / IBBOU (ALG)	7 - 5, 6 - 3
<u>Court 1</u>					
S	R16	MOUNDIR Adam Ralph Khalifa (MAR)	d.	ARNALDI Matteo (ITA)	7 - 5, 6(5) - 7, 6 - 3
S	R16	PASSARO Francesco (ITA)	d.	ELSAYED Amr (EGY)	7 - 6(3), 6 - 2
S	R16	SONMEZ Zeynep (TUR)	d.	BAJRI Gresli (ALB)	6 - 1, 6 - 2
D	QF	BENCHETRIT / MOUNDIR (MAR)	d.	DOMINKO / PREMZL (SLO)	6 - 4, 6 - 4
<u>Court 2</u>					
S	R16	BRANCACCIO Nuria (ITA)	d.	PELLICANO Helene (MLT)	
S	R16	BOUZAS MANEIRO Jessica (ESP)	d.	ALVES CAMPINO Mariana (POR)	6 - 4, 6 - 2
S	R16	YORUK İlay (TUR)	d.	GJINAJ Vesa (KOS)	6 - 1, 6 - 1
D	QF	ARNALDI / PASSARO (ITA)	d.	CHRYSOCHOS / NEOS (CYP)	6 - 3, 6 - 2
<u>Court 3</u>					
S	R16	MONTAGUD Carlos Lopez (ESP)	d.	ASCIK Matthew (MLT)	6 - 2, 6 - 1
S	R16	BENCHETRIT Elliot Joseph Jean (MAR)	d.	DELICATA Liam (MLT)	6 - 2, 6 - 1
D	QF	BRANCACCIO / ZANTEDESCHI (ITA)	d.	ABDELSALAM / EL SAYED (EGY)	6 - 4, 6 - 2
D	QF	MONTAGUD / SAN MARTIN (ESP)	d.	ELSAYED / MAAMOUN (EGY)	6 - 4, 6 - 2
<u>Court 4</u>					
S	R16	MAAMOUN Karim Mohamed (EGY)	d.	EREL Yanki (TUR)	6 - 4, 6 - 4
S	R16	BECHRI Chiraz (TUN)	d.	SAMIR Sandra (EGY)	6 - 1, 3 - 6, 6 - 3
D	QF	CURMI / GENOVESE (MLT)	d.	EL AOUNI / KABBAJ (MAR)	7 - 6(1), 7 - 6(5)
D	QF	BECHRI / BEN HASSEN (TUN)	d.	ERAYDIN / TURKMEN (TUR)	6(6) - 7, 6 - 4, [10] - [6]
<u>Court 5</u>					
S	R16	SAN MARTIN Alvaro L. (ESP)	d.	OUAKAA Mohamed Aziz (TUN)	6 - 0, 6 - 1
S	R16	CHRYSOCHOS Petros (CYP)	d.	KIRCI Koroy (TUR)	7 - 6(11), 7 - 5
D	QF	AGABIGUN / ILKEL (TUR)	d.	ABDERRAHMAN / OUAKAA (TUN)	6(5) - 7, 7 - 6(0), [10] - [
<u>Court 6</u>					
S	R16	ZANTEDESCHI Aurora (ITA)	d.	EL AOUNI Aya (MAR)	6 - 4, 7 - 5



## Daily Match Information - Results Summary

As of SAT 2 JUL 2022 at 15:41

29 JUN 2022

Event	Round	Name		Name	Results
<u>C.Court</u>					
S	QF	PASSARO Francesco (ITA)	d.	CHRYSOCHOS Petros (CYP)	6 - 1, 1 - 6, 6 - 1
S	QF	BOUZAS MANEIRO Jessica (ESP)	d.	KABBAJ Yasmine (MAR)	7 - 6(3), 6 - 3
D	SFL	ARNALDI / PASSARO (ITA)	d.	AGABIGUN / ILKEL (TUR)	6 - 2, 6 - 1
<u>Court 1</u>					
S	QF	MONTAGUD Carlos Lopez (ESP)	d.	CATARINA Lucas (MON)	6 - 2, 3 - 6, 6 - 3
S	QF	BENCHETRIT Elliot Joseph Jean (MAR)	d.	SAN MARTIN Alvaro L. (ESP)	6 - 4, 7 - 6(2)
D	SFL	CURMI / GENOVESE (MLT)	d.	BRANCACCIO / ZANTEDESCHI (ITA)	3 - 6, 7 - 6(5), 0 - 0
<u>Court 2</u>					
S	QF	BECHRI Chiraz (TUN)	d.	YORUK Ilay (TUR)	4 - 6, 6 - 1, 6 - 2
S	QF	MOUNDIR Adam Ralph Khalifa (MAR)	d.	MAAMOUN Karim Mohamed (EGY)	6 - 2, 6 - 3
D	SFL	MONTAGUD / SAN MARTIN (ESP)	d.	BENCHETRIT / MOUNDIR (MAR)	6(6) - 7, 7 - 5, [1] - [0]
<u>Court 3</u>					
S	QF	MARISTANY ZULETA Guiomar (ESP)	d.	ZANTEDESCHI Aurora (ITA)	6 - 0, 6 - 1
S	QF	BRANCACCIO Nuria (ITA)	d.	SONMEZ Zeynep (TUR)	6 - 1, 6 - 4
D	SFL	BOUZAS MANEIRO / MARISTANY ZULETA (	d.	BECHRI / BEN HASSEN (TUN)	6 - 4, 6 - 3



## Daily Match Information - Results Summary

As of SAT 2 JUL 2022 at 15:41

30 JUN 2022

Event	Round	Name		Name	Results
<u>C.Court</u>					
S	SFL	PASSARO Francesco (ITA)	d.	BENCHETRIT Elliot Joseph Jean (MAR)	6 - 4, 6 - 2
S	SFL	MARISTANY ZULETA Guiomar (ESP)	d.	BECHRI Chiraz (TUN)	6 - 0, 3 - 1
D	F3	BENCHETRIT / MOUNDIR (MAR)	d.	AGABIGUN / ILKEL (TUR)	6 - 1, 7 - 6(4)
D	F1	ARNALDI / PASSARO (ITA)	d.	MONTAGUD / SAN MARTIN (ESP)	6 - 2, 6 - 3
<u>Court 1</u>					
S	SFL	BRANCACCIO Nuria (ITA)	d.	BOUZAS MANEIRO Jessica (ESP)	5 - 7, 6 - 4, 6 - 3
S	SFL	MONTAGUD Carlos Lopez (ESP)	d.	MOUNDIR Adam Ralph Khalifa (MAR)	3 - 6, 6 - 0, 6 - 1
D	F1	BOUZAS MANEIRO / MARISTANY ZULETA (	d.	CURMI / GENOVESE (MLT)	6 - 3, 6 - 2
<u>Court 2</u>					
S	SF58	CHRYSOCHOS Petros (CYP)	d.	SAN MARTIN Alvaro L. (ESP)	
S	SF58	KABBAJ Yasmine (MAR)	d.	SONMEZ Zeynep (TUR)	
S	F5	ZANTEDESCHI Aurora (ITA)	d.	KABBAJ Yasmine (MAR)	4 - 0



## Daily Match Information - Results Summary

As of SAT 2 JUL 2022 at 15:41

1 JUL 2022

Event	Round	Name	C.Court	Name	Results
S	F1	PASSARO Francesco (ITA)	d.	MONTAGUD Carlos Lopez (ESP)	6(3) - 7, 6 - 4, 6 - 3
S	F1	MARISTANY ZULETA Guiomar (ESP)	d.	BRANCACCIO Nuria (ITA)	6 - 2, 5 - 7, 6 - 2

### LEGEND

<b>F</b> Finals	<b>MD</b> Men's Doubles	<b>MS</b> Men's Singles	<b>MT</b> Men's Team
<b>PR</b> Preliminary	<b>QF</b> Quarterfinals	<b>Rn</b> Round	<b>SF</b> Semifinals
<b>WD</b> Women's Doubles	<b>WS</b> Women's Singles	<b>WT</b> Women's Team	



## Entry List by Country

As of TUE 28 JUN 2022

Country	Gender	Name	Date of Birth	Event	
				Single	Double
ALB - Albania	F	BAJRI Gresi	20 MAR 2006	x	
	F	DULE Kristal	15 NOV 2002	x	
	M	MUEDINI Martin	22 AUG 2002	x	
ALG - Algeria	F	BEKRAR Ines	11 APR 2003		x
	F	BENAISSA Amira	19 DEC 1989	x	
	M	HAMZA REGUIG Samir	19 JAN 2002		x
	F	IBBOU Ines Ferial	5 JAN 1999	x	x
	M	RIHANE Youcef	21 JUN 2001	x	
	M	RITHANE Youcef	7 JAN 1999		x
	M	SAHTALI Toufk	11 SEP 2000	x	
CYP - Cyprus	M	CHRYSOCHOS Petros	8 APR 1996	x	x
	M	EFSTATHIOU Menelaos	2 MAR 1999	x	
	M	NEOS Eleftherios	6 SEP 1999		x
EGY - Egypt	F	ABDELSALAM Sandra			x
	F	EL SAYED Aya		x	x
	M	ELSAYED Amr	4 MAR 1999	x	x
	M	MAAMOUND Karim Mohamed	9 APR 1991	x	x
	F	SALEH Aya	31 MAY 2001	x	
	F	SAMIR Sandra	4 NOV 1997	x	
ESP - Spain	F	BOUZAS MANEIRO Jessica	24 SEP 2002	x	x
	M	LOPEZ MONTAGUD Carlos	6 JUL 2000	x	x
	M	LOPEZ SAN MARTIN Alvaro	2 JUN 1997	x	x
	F	MARISTANY ZULETA Guiomar	19 FEB 1999	x	x
GRE - Greece	M	SKORILAS Alexandros	16 MAR 2000	x	x
	M	THANOS Aristotelis	7 APR 2001	x	x
ITA - Italy	M	ARNALDI Matteo	22 FEB 2001	x	x
	F	BRANCACCIO Nuria	24 JUN 2000	x	x
	M	PASSARO Francesco	7 JAN 2001	x	x
	F	ZANTEDESCHI Aurora	2 NOV 2000	x	x
KOS - Kosovo	F	GJINAJ Vesa	2 DEC 2004	x	
	M	TASHI Vullnet	10 JAN 1993	x	
MAR - Morocco	M	BENCHETRIT Elliot Joseph Jean	2 OCT 1998	x	x
	F	EL AOUNI Aya	6 JUL 2005	x	x
	F	KABBAJ Yasmine	15 JAN 2004	x	x
	M	MOUNDIR Adam Ralph Khalifa	26 APR 1995	x	x
MLT - Malta	M	ASCIK Matthew	4 MAY 1990	x	x
	F	CURMI Francesca	7 JUL 2002	x	x
	M	DE GABRIELE Alex	2 OCT 2004		x
	M	DELICATA Liam	22 APR 2001	x	
	F	GENOVESE Elaine	11 JAN 1991		x
	F	PELLICANO Helene	17 APR 2002	x	
MON - Monaco	M	CATARINA Lucas	26 AUG 1996	x	



## Entry List by Country

As of TUE 28 JUN 2022

Country	Gender	Name	Date of Birth	Event	
				Single	Double
POR - Portugal	F	ALVES CAMPINO Mariana	16 JUN 2003	x	x
	M	COSTA COELHO Fabio Alexandre	24 MAY 2000	x	x
	F	FONTE Maria Inês	1 FEB 2002	x	x
	M	GOMES Miguel	6 APR 2003	x	x
SLO - Slovenia	M	DOMINKO Sebastian	13 MAY 2003	x	x
	F	FALKNER Ziva	7 JUL 2002	x	x
	F	LOVRIC Pia	23 APR 2002	x	x
	M	PREMZL Maj	31 JAN 2004	x	x
SMR - San Marino	M	DE ROSSI Marco	27 JUN 1997	x	
TUN - Tunisia	M	ABDERRAHMAN Wissam	13 OCT 2003	x	x
	F	BECHRI Chiraz	23 JUL 1998	x	x
	F	BEN HASSEN Feryel	6 OCT 2004	x	x
	M	OUAKAA Mohamed Aziz	7 AUG 1999	x	x
TUR - Turkey	M	AGABIGUN Ilhan Sarp	12 JUN 1997		x
	F	ERAYIN Basak	21 JUN 1994		x
	M	EREL Yanki	25 SEP 2000	x	
	M	ILKEL Berk	28 JUL 2001	x	x
	M	KIRCI Koroy		x	
	F	SONMEZ Zeynep	30 APR 2002	x	
	F	TURKMEN Doga	10 OCT 2002		x
	F	YORUK Ilay	5 NOV 2001	x	





## Entry List by Event

As of TUE 28 JUN 2022

Rank	Name	CTRY	Seed
	MUEDINI Martin	ALB	
	RIHANE Youcef	ALG	
1420	SAHTALI Toufk	ALG	
661	CHRYSOCHOS Petros	CYP	
1073	EFSTATHIOU Menelaos	CYP	
983	ELSAYED Amr	EGY	
861	MAAMOUND Karim Mohamed	EGY	
484	LOPEZ MONTAGUD Carlos	ESP	
479	LOPEZ SAN MARTIN Alvaro	ESP	
1493	SKORILAS Alexandros	GRE	
1129	THANOS Aristotelis	GRE	
229	ARNALDI Matteo	ITA	
253	PASSARO Francesco	ITA	
	TASHI Vullnet	KOS	
435	BENCHETRIT Elliot Joseph Jean	MAR	
887	MOUNDIR Adam Ralph Khalifa	MAR	
	ASCIAK Matthew	MLT	
	DELICATA Liam	MLT	
475	CATARINA Lucas	MON	
933	COSTA COELHO Fabio Alexandre	POR	
1665	GOMES Miguel	POR	
1438	DOMINKO Sebastian	SLO	
	PREMZL Maj	SLO	
1181	DE ROSSI Marco	SMR	
1059	ABDERRAHMAN Wissam	TUN	
995	OUAKAA Mohamed Aziz	TUN	
506	EREL Yanki	TUR	
	ILKEL Berk	TUR	
994	KIRCI Koroy	TUR	



## Medallists

As of FRI 1 JUL 2022 at 21:59

Medal	Name	CTRY
GOLD	PASSARO Francesco	ITA - Italy
SILVER	MONTAGUD Carlos Lopez	ESP - Spain
BRONZE	MOUNDIR Adam Ralph Khalifa	MAR - Morocco





FRI 1 JUL 2022

Match Statistics

	MONTAGUD Carlos Lopez	ESP	7	4	3
<b>W</b>	<b>PASSARO Francesco</b>	<b>ITA</b>	<b>6(3)</b>	<b>6</b>	<b>6</b>
Match duration: 02h28min			63min	47min	38min

C.Court

MONTAGUD Carlos Lopez				PASSARO Francesco				
1st Set	2nd Set	3rd Set	Total		1st Set	2nd Set	3rd Set	Total
2	0	0	<b>2</b>	Total aces	0	1	1	<b>2</b>
1	0	1	<b>2</b>	Double faults	2	0	1	<b>3</b>
37/52	34/42	18/28	<b>89/122</b>	1st serve	30/40	21/29	15/24	<b>66/93</b>
(71%)	(81%)	(64%)	<b>(73%)</b>	Aces on 1st serve	0	1	1	<b>2</b>
2	0	0	<b>2</b>	Points on 1st serve	21/30	15/21	11/15	<b>47/66</b>
23/37	18/34	11/18	<b>52/89</b>	2nd serve	8/10	8/8	8/9	<b>24/27</b>
(62%)	(53%)	(61%)	<b>(58%)</b>	Aces on 2nd serve	0	0	0	<b>0</b>
14/15	8/8	9/10	<b>31/33</b>	Points on 2nd serve	5/10	3/8	6/9	<b>14/27</b>
(93%)	(100%)	(90%)	<b>(94%)</b>	Receive points won	19/52	20/42	12/28	<b>51/122</b>
0	0	0	<b>0</b>	Break point convers.	1/8	2/8	2/2	<b>5/18</b>
10/15	4/8	5/10	<b>19/33</b>	Total points won	45	38	29	<b>112</b>
(67%)	(50%)	(50%)	<b>(58%)</b>					
14/40	11/29	7/24	<b>32/93</b>					
(35%)	(38%)	(29%)	<b>(34%)</b>					
1/3	1/1	0/0	<b>2/4</b>					
(33%)	(100%)	(0%)	<b>(50%)</b>					
47	33	23	<b>103</b>					

	1st Set							2nd Set							3rd Set																												
MONTAGUD Carlos Lopez	1	*2	2	*3	3	*4	4	*5	5	*6	6	*7	7	*1	1	*2	2	*3	3	*4	4	*5	5	*6	6	*7	7	*1	1	*2	2	*3	3	*4	4	*5	5	*6	6	*7	7		
PASSARO Francesco	*0	0	*1	1	*2	2	*3	3	*4	4	*5	5	*6	6	6(3)	0	*1	1	*1	1	*2	2	*3	3	*4	4	*5	5	*6	6	0	*1	1	*2	2	*3	3	*4	4	*5	5	*6	6

<b>LEGEND</b>		
* Server	RET Retired	W Winner
-		





THU 30 JUN 2022

Match Statistics

	MOUNDIR Adam Ralph Khalifa	MAR	6	0	1
<b>W</b>	<b>MONTAGUD Carlos Lopez</b>	<b>ESP</b>	<b>3</b>	<b>6</b>	<b>6</b>
Match duration: 01h36min			40min	27min	29min

Court 1

MOUNDIR Adam Ralph Khalifa				MONTAGUD Carlos Lopez				
1st Set	2nd Set	3rd Set	Total		1st Set	2nd Set	3rd Set	Total
3	0	0	<b>3</b>	Total aces	0	0	0	<b>0</b>
0	0	0	<b>0</b>	Double faults	1	0	1	<b>2</b>
24/39	12/15	15/22	<b>51/76</b>	1st serve	15/22	18/22	11/20	<b>44/64</b>
(62%)	(80%)	(68%)	<b>(67%)</b>		(68%)	(82%)	(55%)	<b>(69%)</b>
3	0	0	<b>3</b>	Aces on 1st serve	0	0	0	<b>0</b>
16/24	3/12	6/15	<b>25/51</b>	Points on 1st serve	11/15	11/18	10/11	<b>32/44</b>
(67%)	(25%)	(40%)	<b>(49%)</b>		(73%)	(61%)	(91%)	<b>(73%)</b>
15/15	3/3	7/7	<b>25/25</b>	2nd serve	6/7	4/4	8/9	<b>18/20</b>
(100%)	(100%)	(100%)	<b>(100%)</b>		(86%)	(100%)	(89%)	<b>(90%)</b>
0	0	0	<b>0</b>	Aces on 2nd serve	0	0	0	<b>0</b>
10/15	0/3	3/7	<b>13/25</b>	Points on 2nd serve	4/7	4/4	6/9	<b>14/20</b>
(67%)	(0%)	(43%)	<b>(52%)</b>		(57%)	(100%)	(67%)	<b>(70%)</b>
7/22	7/22	4/20	<b>18/64</b>	Receive points won	13/39	12/15	13/22	<b>38/76</b>
(32%)	(32%)	(20%)	<b>(28%)</b>		(33%)	(80%)	(59%)	<b>(50%)</b>
1/1	0/0	0/0	<b>1/1</b>	Break point convers.	0/3	3/3	2/2	<b>5/8</b>
(100%)	(0%)	(0%)	<b>(100%)</b>		(0%)	(100%)	(100%)	<b>(62%)</b>
33	10	13	<b>56</b>	Total points won	28	27	29	<b>84</b>

	1st Set						2nd Set						3rd Set									
MOUNDIR Adam Ralph Khalifa	*1	1	*2	2	*3	4	*5	5	*6	0	*0	0	*0	0	*0	0	*0	0	*1	1	*1	1
MONTAGUD Carlos Lopez	0	*1	1	*2	2	*2	2	*3	3	*1	2	*3	4	*5	6	*1	2	*3	3	*4	5	*6

LEGEND

\* Server  
 RET Retired  
 W Winner  
 - -





THU 30 JUN 2022

**Match Statistics**

	BENCHETRIT Elliot Joseph Jean	MAR	4	2
<b>W</b>	<b>PASSARO Francesco</b>	<b>ITA</b>	<b>6</b>	<b>6</b>
	Match duration: 01h31min		52min	39min

C.Court

BENCHETRIT Elliot Joseph Jean				PASSARO Francesco				
1st Set	2nd Set	3rd Set	Total		1st Set	2nd Set	3rd Set	Total
0	0		<b>0</b>	Total aces	2	3		<b>5</b>
1	0		<b>1</b>	Double faults	2	1		<b>3</b>
24/34	22/30		<b>46/64</b>	1st serve	20/35	14/22		<b>34/57</b>
(71%)	(73%)		<b>(72%)</b>		(57%)	(64%)		<b>(60%)</b>
0	0		<b>0</b>	Aces on 1st serve	2	3		<b>5</b>
12/24	12/22		<b>24/46</b>	Points on 1st serve	13/20	11/14		<b>24/34</b>
(50%)	(55%)		<b>(52%)</b>		(65%)	(79%)		<b>(71%)</b>
9/10	8/8		<b>17/18</b>	2nd serve	13/15	7/8		<b>20/23</b>
(90%)	(100%)		<b>(94%)</b>		(87%)	(88%)		<b>(87%)</b>
0	0		<b>0</b>	Aces on 2nd serve	0	0		<b>0</b>
4/10	3/8		<b>7/18</b>	Points on 2nd serve	7/15	6/8		<b>13/23</b>
(40%)	(38%)		<b>(39%)</b>		(47%)	(75%)		<b>(57%)</b>
15/35	5/22		<b>20/57</b>	Receive points won	18/34	15/30		<b>33/64</b>
(43%)	(23%)		<b>(35%)</b>		(53%)	(50%)		<b>(52%)</b>
2/5	0/2		<b>2/7</b>	Break point convers.	3/8	2/4		<b>5/12</b>
(40%)	(0%)		<b>(29%)</b>		(38%)	(50%)		<b>(42%)</b>
31	20		<b>51</b>	Total points won	38	32		<b>70</b>

	1st Set										2nd Set									
BENCHETRIT Elliot Joseph Jean	*0	0	*0	1	*2	3	*3	3	*4	4	*0	0	*1	1	*1	1	*2	2		
PASSARO Francesco	1	*2	3	*3	3	*3	4	*5	5	*6	1	*2	2	*3	4	*5	5	*6		

**LEGEND**

\* Server    RET Retired    W Winner  
 - -



## Entry List by Event

As of TUE 28 JUN 2022

Rank	Name	CTRY	Seed
	HAMZA REGUIG Samir RITHANE Youcef	ALG	
	CHRYSOCHOS Petros NEOS Eleftherios	CYP	
	ELSAYED Amr MAAMOUND Karim Mohamed	EGY	
	LOPEZ MONTAGUD Carlos LOPEZ SAN MARTIN Alvaro	ESP	
	SKORILAS Alexandros THANOS Aristotelis	GRE	
	ARNALDI Matteo PASSARO Francesco	ITA	
	BENCHETRIT Elliot Joseph Jean MOUNDIR Adam Ralph Khalifa	MAR	
	ASCIAK Matthew DE GABRIELE Alex	MLT	
	COSTA COELHO Fabio Alexandre GOMES Miguel	POR	
	DOMINKO Sebastian PREMZL Maj	SLO	
	ABDERRAHMAN Wissam OUAKAA Mohamed Aziz	TUN	
	AGABIGUN Ilhan Sarp ILKEL Berk	TUR	



## Team Medallists

Medal	CTRY	Name
GOLD	ITA - Italy	ARNALDI Matteo PASSARO Francesco
SILVER	ESP - Spain	MONTAGUD Carlos Lopez SAN MARTIN Alvaro L.
BRONZE	MAR - Morocco	BENCHETRIT Elliot Joseph Jean MOUNDIR Adam Ralph Khalifa





**Draw**  
As of SAT 2 JUL 2022 at 15:08

Rank	Round of 16	Seed	NOC	Quarter-finals	Semi-finals	Gold-medal Match	
	ARNALDI M./PASSARO F.		ITA	ARNALDI M./PASSARO F.	ARNALDI M./PASSARO F. 6 - 3, 6 - 2	ARNALDI M./PASSARO F. 6 - 2, 6 - 1	
	BYE						
	CHRYSOCHOS P./NEOS E.		CYP	CHRYSOCHOS P./NEOS E. 3 - 0			
	SKORILAS A./THANOS A.		GRE				
	ABDERRAHMAN/OUAKAA M.		TUN	ABDERRAHMAN/OUAKAA M.			
	BYE						
	AGABIGUN I./ILKEL B.		TUR	AGABIGUN I./ILKEL B. 7 - 5, 6 - 2	AGABIGUN I./ILKEL B. 6(5) - 7, 7 - 6(0), [10] - [2]		
	COSTA COELHO F./GOMES M.		POR				
	HAMZA REGUIGRITHANE Y.		ALG	DOMINKO S./PREMZL M. 3 - 6, 6 - 4, [10] - [8]	BENCHETRIT E./MOUNDIR A. 6 - 4, 6 - 4	MONTAGUD C.L./SAN MARTIN A.L. 6(6) - 7, 7 - 5, [1] - [0]	
	DOMINKO S./PREMZL M.		SLO				
	BYE						
	BENCHETRIT E./MOUNDIR A.		MAR	BENCHETRIT E./MOUNDIR A.			
	ASCIAK M./DE GABRIELE A.		MLT	ELSAYED A./MAAMOUN K.M. 6 - 2, 7 - 5	MONTAGUD C.L./SAN MARTIN A.L. 6 - 4, 6 - 2		MONTAGUD C.L./SAN MARTIN A.L. 6(6) - 7, 7 - 5, [1] - [0]
	ELSAYED A./MAAMOUN K.M.		EGY				
	BYE						
	MONTAGUD C.L./SAN MARTI		ESP	MONTAGUD C.L./SAN MARTIN A.L.			
					AGABIGUN I./ILKEL B.		
					BENCHETRIT E./MOUNDIR A.		

CLASSIFICATION		
Gold	ARNALDI/PASSARO	ITA
Silver	MONTAGUD/SAN MARTIN	ESP
Bronze	BENCHETRIT/MOUNDIR	MAR

Gold Medal

ARNALDI/PASSARO

6 - 2, 6 - 3

Bronze Medal

BENCHETRIT/MOUNDIR

6 - 1, 7 - 6(4)

**LEGEND**

ALT Alternate

W/O Walk-Over



THU 30 JUN 2022

### Match Statistics - Double

<b>W</b>	<b>ARNALDI Matteo</b>	<b>ITA</b>	<b>6</b>	<b>6</b>
	<b>PASSARO Francesco</b>			
	MONTAGUD Carlos Lopez	ESP	2	3
	SAN MARTIN Alvaro L.			
Match duration: 01h06min			34min	32min

C.Court

ARNALDI,M./PASSARO,F.				MONTAGUD,C.L./SAN MARTIN,A.L				
1st Set	2nd Set	3rd Set	Total		1st Set	2nd Set	3rd Set	Total
2	0		<b>2</b>	Total aces	0	2		<b>2</b>
0	0		<b>0</b>	Double faults	0	1		<b>1</b>
20/23	20/27		<b>40/50</b>	1st serve	12/24	15/21		<b>27/45</b>
(87%)	(74%)		<b>(80%)</b>	Aces on 1st serve	(50%)	(71%)		<b>(60%)</b>
1	0		<b>1</b>	Points on 1st serve	0	2		<b>2</b>
13/20	16/20		<b>29/40</b>	2nd serve	7/12	10/15		<b>17/27</b>
(65%)	(80%)		<b>(72%)</b>	Aces on 2nd serve	(58%)	(67%)		<b>(63%)</b>
3/3	7/7		<b>10/10</b>	Points on 2nd serve	12/12	5/6		<b>17/18</b>
(100%)	(100%)		<b>(100%)</b>	Receive points won	(100%)	(83%)		<b>(94%)</b>
1	0		<b>1</b>	Break point convers.	0	0		<b>0</b>
1/3	4/7		<b>5/10</b>	Total points won	4/12	3/6		<b>7/18</b>
(33%)	(57%)		<b>(50%)</b>		(33%)	(50%)		<b>(39%)</b>
13/24	8/21		<b>21/45</b>		9/23	7/27		<b>16/50</b>
(54%)	(38%)		<b>(47%)</b>		(39%)	(26%)		<b>(32%)</b>
3/4	1/1		<b>4/5</b>		1/1	0/0		<b>1/1</b>
(75%)	(100%)		<b>(80%)</b>		(100%)	(0%)		<b>(100%)</b>
27	28		<b>55</b>		20	20		<b>40</b>

	1st Set							2nd Set									
ARNALDI/PASSARO	*1	1	*2	3	*3	4	*5	6	*1	1	*2	3	*4	4	*5	5	*6
MONTAGUD/SAN MARTIN	0	*1	1	*1	2	*2	2	*2	0	*1	1	*1	1	*2	2	*3	3

**LEGEND**

\* Server

RET Retired

W Winner

- -



THU 30 JUN 2022

Match Statistics - Double

	AGABIGUN Ilhan Sarp ILKEL Berk	TUR	1	6(4)
<b>W</b>	<b>BENCHETRIT Elliot Joseph Jean</b> <b>MOUNDIR Adam Ralph Khalifa</b>	<b>MAR</b>	<b>6</b>	<b>7</b>
	Match duration: 01h31min		32min	59min

C.Court

AGABIGUN,I./ILKEL,B.				BENCHETRIT,E./MOUNDIR,A.				
1st Set	2nd Set	3rd Set	Total		1st Set	2nd Set	3rd Set	Total
0	0		<b>0</b>	Total aces	0	1		<b>1</b>
0	2		<b>2</b>	Double faults	0	0		<b>0</b>
14/19 (74%)	27/39 (69%)		<b>41/58</b> <b>(71%)</b>	1st serve	13/23 (57%)	26/40 (65%)		<b>39/63</b> <b>(62%)</b>
0	0		<b>0</b>	Aces on 1st serve	0	1		<b>1</b>
7/14 (50%)	16/27 (59%)		<b>23/41</b> <b>(56%)</b>	Points on 1st serve	9/13 (69%)	19/26 (73%)		<b>28/39</b> <b>(72%)</b>
5/5 (100%)	10/12 (83%)		<b>15/17</b> <b>(88%)</b>	2nd serve	10/10 (100%)	14/14 (100%)		<b>24/24</b> <b>(100%)</b>
0	0		<b>0</b>	Aces on 2nd serve	0	0		<b>0</b>
2/5 (40%)	4/12 (33%)		<b>6/17</b> <b>(35%)</b>	Points on 2nd serve	7/10 (70%)	5/14 (36%)		<b>12/24</b> <b>(50%)</b>
7/23 (30%)	16/40 (40%)		<b>23/63</b> <b>(37%)</b>	Receive points won	10/19 (53%)	19/39 (49%)		<b>29/58</b> <b>(50%)</b>
0/3 (0%)	2/3 (67%)		<b>2/6</b> <b>(33%)</b>	Break point convers.	2/5 (40%)	2/6 (33%)		<b>4/11</b> <b>(36%)</b>
16	36		<b>52</b>	Total points won	26	43		<b>69</b>

	1st Set							2nd Set												
AGABIGUN/ILKEL	0	*0	0	*1	1	*1	1	*0	1	*1	2	*3	3	*4	4	*5	5	*6	6	6(4)
BENCHETRIT/MOUNDIR	*1	2	*3	3	*4	5	*6	1	*1	2	*2	2	*3	3	*4	4	*5	5	*6	7

LEGEND

\* Server      RET Retired      W Winner  
- -



WED 29 JUN 2022

**Match Statistics - Double**

W	<b>ARNALDI Matteo</b>	<b>ITA</b>	<b>6</b>	<b>6</b>
	<b>PASSARO Francesco</b>			
	AGABIGUN Ilhan Sarp	TUR	2	1
	ILKEL Berk			
Match duration: 00h51min			26min	25min

C.Court

ARNALDI,M./PASSARO,F.				AGABIGUN,I./ILKEL,B.				
1st Set	2nd Set	3rd Set	Total		1st Set	2nd Set	3rd Set	Total
2	0		<b>2</b>	Total aces	0	0		<b>0</b>
0	1		<b>1</b>	Double faults	1	0		<b>1</b>
14/18	18/25		<b>32/43</b>	1st serve	19/22	15/18		<b>34/40</b>
(78%)	(72%)		<b>(74%)</b>		(86%)	(83%)		<b>(85%)</b>
2	0		<b>2</b>	Aces on 1st serve	0	0		<b>0</b>
13/14	13/18		<b>26/32</b>	Points on 1st serve	11/19	7/15		<b>18/34</b>
(93%)	(72%)		<b>(81%)</b>		(58%)	(47%)		<b>(53%)</b>
4/4	6/7		<b>10/11</b>	2nd serve	2/3	3/3		<b>5/6</b>
(100%)	(86%)		<b>(91%)</b>		(67%)	(100%)		<b>(83%)</b>
0	0		<b>0</b>	Aces on 2nd serve	0	0		<b>0</b>
3/4	5/7		<b>8/11</b>	Points on 2nd serve	2/3	1/3		<b>3/6</b>
(75%)	(71%)		<b>(73%)</b>		(67%)	(33%)		<b>(50%)</b>
9/22	10/18		<b>19/40</b>	Receive points won	2/18	7/25		<b>9/43</b>
(41%)	(56%)		<b>(48%)</b>		(11%)	(28%)		<b>(21%)</b>
2/2	2/2		<b>4/4</b>	Break point convers.	0/0	0/1		<b>0/1</b>
(100%)	(100%)		<b>(100%)</b>		(0%)	(0%)		<b>(0%)</b>
25	28		<b>53</b>	Total points won	15	15		<b>30</b>

	1st Set						2nd Set								
ARNALDI/PASSARO	*1	1	*2	3	*4	4	*5	6	*1	2	*3	4	*5	5	*6
AGABIGUN/ILKEL	0	*1	1	*1	1	*2	2	*2	0	*0	0	*0	0	*1	1

**LEGEND**

\* Server  
-  
RET Retired  
W Winner



WED 29 JUN 2022

Match Statistics - Double

	BENCHETRIT Elliot Joseph Jean MOUNDIR Adam Ralph Khalifa	MAR	7	5	[0]
W	<b>MONTAGUD Carlos Lopez</b> <b>SAN MARTIN Alvaro L.</b>	ESP	<b>6(6)</b>	<b>7</b>	<b>[1]</b>
Match duration: 01h38min			54min	44min	0min

Court 2

BENCHETRIT,E./MOUNDIR,A.				MONTAGUD,C.L./SAN MARTIN,A.L				
1st Set	2nd Set	3rd Set	Total		1st Set	2nd Set	3rd Set	Total
2	3	0	<b>5</b>	Total aces	0	1	0	<b>1</b>
2	1	0	<b>3</b>	Double faults	1	1	0	<b>2</b>
26/36 (72%)	23/33 (70%)	1/1 (100%)	<b>50/70 (71%)</b>	1st serve	37/49 (76%)	21/30 (70%)	0/0 (0%)	<b>58/79 (73%)</b>
2	3	0	<b>5</b>	Aces on 1st serve	0	1	0	<b>1</b>
10/26 (38%)	16/23 (70%)	0/1 (0%)	<b>26/50 (52%)</b>	Points on 1st serve	13/37 (35%)	14/21 (67%)	0/0 (0%)	<b>27/58 (47%)</b>
8/10 (80%)	9/10 (90%)	0/0 (0%)	<b>17/20 (85%)</b>	2nd serve	11/12 (92%)	7/8 (88%)	0/0 (0%)	<b>18/20 (90%)</b>
0	0	0	<b>0</b>	Aces on 2nd serve	0	0	0	<b>0</b>
2/10 (20%)	3/10 (30%)	0/0 (0%)	<b>5/20 (25%)</b>	Points on 2nd serve	6/12 (50%)	4/8 (50%)	0/0 (0%)	<b>10/20 (50%)</b>
30/49 (61%)	11/30 (37%)	0/0 (0%)	<b>41/79 (52%)</b>	Receive points won	24/36 (67%)	14/33 (42%)	1/1 (100%)	<b>39/70 (56%)</b>
5/7 (71%)	1/1 (100%)	0/0 (0%)	<b>6/8 (75%)</b>	Break point convers.	5/6 (83%)	2/3 (67%)	0/0 (0%)	<b>7/9 (78%)</b>
42	30	0	<b>72</b>	Total points won	43	32	1	<b>76</b>

	1st Set							2nd Set							3rd Set										
BENCHETRIT/MOUNDIR	1	*1	1	*1	2	*2	3	*4	5	*5	6	*6	7	*1	2	*3	3	*3	3	*4	4	*5	5	*5	[0]
MONTAGUD/SAN MARTIN	*0	1	*2	3	*3	4	*4	4	*4	5	*5	6	6(6)	0	*0	0	*1	2	*3	3	*4	4	*5	6	[1]

<b>LEGEND</b>				
* Server	RET Retired	W Winner		
-				



## Entry List by Event

As of SUN 26 JUN 2022

Rank	Name	CTRY	Seed
	BAJRI Gresl	ALB	
	DULE Kristal	ALB	
	BENAISSA Amira	ALG	
652	IBBOU Ines Feriel	ALG	
1203	EL SAYED Aya	EGY	
	SALEH Aya	EGY	
411	SAMIR Sandra	EGY	
309	BOUZAS MANEIRO Jessica	ESP	
335	MARISTANY ZULETA Guiomar	ESP	
453	BRANCACCIO Nuria	ITA	
621	ZANTEDESCHI Aurora	ITA	
	GJINAJ Vesa	KOS	
1302	EL AOUNI Aya	MAR	
	KABBAJ Yasmine	MAR	
905	CURMI Francesca	MLT	
998	PELLICANO Helene	MLT	
1607	ALVES CAMPINO Mariana	POR	
1278	FONTE Maria Inés	POR	
	FALKNER Ziva	SLO	
	LOVRIC Pia	SLO	
724	BECHRI Chiraz	TUN	
	BEN HASSEN Feryel	TUN	
517	SONMEZ Zeynep	TUR	
594	YORUK Ilay	TUR	



## Medallists

As of SAT 2 JUL 2022 at 15:15

Medal	Name	CTRY
GOLD	MARISTANY ZULETA Guiomar	ESP - Spain
SILVER	BRANCACCIO Nuria	ITA - Italy
BRONZE	BOUZAS MANEIRO Jessica	ESP - Spain



### Draw As of SAT 2 JUL 2022 at 15:15

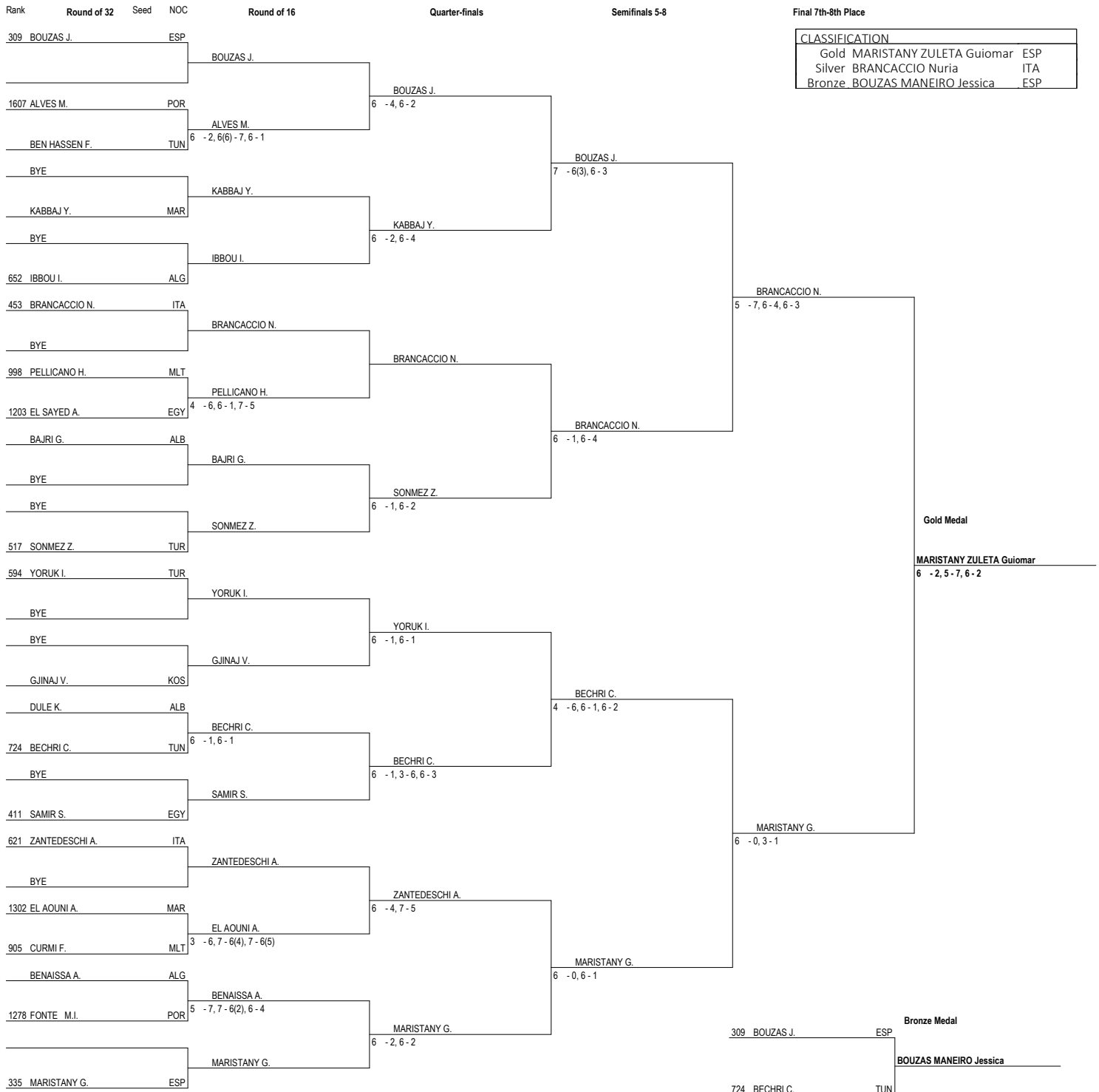

**LEGEND**

ALT Alternate W/O Walk-Over





FRI 1 JUL 2022

**Match Statistics**

	BRANCACCIO Nuria	ITA	2	7	2
<b>W</b>	<b>MARISTANY ZULETA Guiomar</b>	<b>ESP</b>	<b>6</b>	<b>5</b>	<b>6</b>
Match duration: 02h06min			32min	62min	32min

C.Court

BRANCACCIO Nuria				MARISTANY ZULETA Guiomar				
1st Set	2nd Set	3rd Set	Total		1st Set	2nd Set	3rd Set	Total
0	0	1	<b>1</b>	Total aces	0	2	1	<b>3</b>
3	1	0	<b>4</b>	Double faults	0	3	0	<b>3</b>
21/28	27/35	23/27	<b>71/90</b>	1st serve	14/17	44/56	13/19	<b>71/92</b>
(75%)	(77%)	(85%)	<b>(79%)</b>		(82%)	(79%)	(68%)	<b>(77%)</b>
0	0	1	<b>1</b>	Aces on 1st serve	0	2	1	<b>3</b>
11/21	19/27	10/23	<b>40/71</b>	Points on 1st serve	13/14	24/44	10/13	<b>47/71</b>
(52%)	(70%)	(43%)	<b>(56%)</b>		(93%)	(55%)	(77%)	<b>(66%)</b>
4/7	7/8	4/4	<b>15/19</b>	2nd serve	3/3	9/12	6/6	<b>18/21</b>
(57%)	(88%)	(100%)	<b>(79%)</b>		(100%)	(75%)	(100%)	<b>(86%)</b>
0	0	0	<b>0</b>	Aces on 2nd serve	0	0	0	<b>0</b>
2/7	3/8	1/4	<b>6/19</b>	Points on 2nd serve	3/3	5/12	2/6	<b>10/21</b>
(29%)	(38%)	(25%)	<b>(32%)</b>		(100%)	(42%)	(33%)	<b>(48%)</b>
1/17	27/56	7/19	<b>35/92</b>	Receive points won	15/28	13/35	16/27	<b>44/90</b>
(6%)	(48%)	(37%)	<b>(38%)</b>		(54%)	(37%)	(59%)	<b>(49%)</b>
0/0	3/12	1/1	<b>4/13</b>	Break point convers.	2/5	2/4	3/6	<b>7/15</b>
(0%)	(25%)	(100%)	<b>(31%)</b>		(40%)	(50%)	(50%)	<b>(47%)</b>
14	49	18	<b>81</b>	Total points won	31	42	28	<b>101</b>

	1st Set								2nd Set								3rd Set											
BRANCACCIO Nuria	0	*0	0	*1	1	*2	2	*2	1	*2	2	*2	3	*3	3	*4	4	*5	6	*7	0	*0	0	*1	2	*2	2	*2
MARISTANY ZULETA Guiomar	*1	2	*3	3	*4	4	*5	6	*0	0	*1	2	*2	3	*4	4	*5	5	*5	5	*1	2	*3	3	*3	4	*5	6

**LEGEND**

 \* Server  
- -

RET Retired

W Winner



THU 30 JUN 2022

**Match Statistics**

BOUZAS MANEIRO Jessica	ESP	7	4	3
<b>W</b> BRANCACCIO Nuria	<b>ITA</b>	<b>5</b>	<b>6</b>	<b>6</b>
Match duration: 02h00min		40min	41min	39min

Court 1

BOUZAS MANEIRO Jessica					BRANCACCIO Nuria			
1st Set	2nd Set	3rd Set	Total		1st Set	2nd Set	3rd Set	Total
1	0	2	<b>3</b>	Total aces	0	0	0	<b>0</b>
0	4	2	<b>6</b>	Double faults	0	0	0	<b>0</b>
23/29	24/31	25/35	<b>72/95</b>	1st serve	39/57	23/32	16/21	<b>78/110</b>
(79%)	(77%)	(71%)	<b>(76%)</b>		(68%)	(72%)	(76%)	<b>(71%)</b>
1	0	2	<b>3</b>	Aces on 1st serve	0	0	0	<b>0</b>
14/23	13/24	13/25	<b>40/72</b>	Points on 1st serve	20/39	14/23	13/16	<b>47/78</b>
(61%)	(54%)	(52%)	<b>(56%)</b>		(51%)	(61%)	(81%)	<b>(60%)</b>
6/6	3/7	8/10	<b>17/23</b>	2nd serve	18/18	9/9	5/5	<b>32/32</b>
(100%)	(43%)	(80%)	<b>(74%)</b>		(100%)	(100%)	(100%)	<b>(100%)</b>
0	0	0	<b>0</b>	Aces on 2nd serve	0	0	0	<b>0</b>
4/6	2/7	3/10	<b>9/23</b>	Points on 2nd serve	9/18	4/9	2/5	<b>15/32</b>
(67%)	(29%)	(30%)	<b>(39%)</b>		(50%)	(44%)	(40%)	<b>(47%)</b>
28/57	14/32	6/21	<b>48/110</b>	Receive points won	11/29	16/31	19/35	<b>46/95</b>
(49%)	(44%)	(29%)	<b>(44%)</b>		(38%)	(52%)	(54%)	<b>(48%)</b>
3/8	2/3	1/1	<b>6/12</b>	Break point convers.	2/3	3/3	3/4	<b>8/10</b>
(38%)	(67%)	(100%)	<b>(50%)</b>		(67%)	(100%)	(75%)	<b>(80%)</b>
46	29	22	<b>97</b>	Total points won	40	34	34	<b>108</b>

	1st Set							2nd Set							3rd Set																
BOUZAS MANEIRO Jessica	*0	0	*1	1	*2	3	*4	5	*5	5	*6	7	*0	1	*1	2	*3	3	*3	3	*4	4	*1	1	*1	1	*1	1	*2	3	*3
BRANCACCIO Nuria	1	*2	2	*3	3	*3	3	*3	4	*5	5	*5	1	*1	2	*2	2	*3	4	*5	5	*6	0	*1	2	*3	4	*5	5	*5	6

**LEGEND**

 \* Server  
 - -

RET Retired

W Winner



THU 30 JUN 2022

**Match Statistics**

	BECHRI Chiraz	TUN	0	1	<b>ACC</b>
<b>W</b>	<b>MARISTANY ZULETA Guiomar</b>	<b>ESP</b>	<b>6</b>	<b>3</b>	
	Match duration: 00h57min		36min	21min	

C.Court

BECHRI Chiraz				MARISTANY ZULETA Guiomar				
1st Set	2nd Set	3rd Set	Total		1st Set	2nd Set	3rd Set	Total
0	1		<b>1</b>	Total aces	1	0		<b>1</b>
0	0		<b>0</b>	Double faults	1	0		<b>1</b>
11/25	7/9		<b>18/34</b>	1st serve	13/22	6/11		<b>19/33</b>
(44%)	(78%)		<b>(53%)</b>	Aces on 1st serve	(59%)	(55%)		<b>(58%)</b>
0	1		<b>1</b>	Points on 1st serve	9/13	4/6		<b>13/19</b>
3/11	4/7		<b>7/18</b>	2nd serve	(69%)	(67%)		<b>(68%)</b>
(27%)	(57%)		<b>(39%)</b>	Aces on 2nd serve	8/9	5/5		<b>13/14</b>
14/14	2/2		<b>16/16</b>	Points on 2nd serve	(89%)	(100%)		<b>(93%)</b>
(100%)	(100%)		<b>(100%)</b>	Receive points won	5/9	4/5		<b>9/14</b>
0	0		<b>0</b>	Break point convers.	(56%)	(80%)		<b>(64%)</b>
6/14	1/2		<b>7/16</b>	Total points won	16/25	4/9		<b>20/34</b>
(43%)	(50%)		<b>(44%)</b>		(64%)	(44%)		<b>(59%)</b>
8/22	3/11		<b>11/33</b>		3/5	1/1		<b>4/6</b>
(36%)	(27%)		<b>(33%)</b>		(60%)	(100%)		<b>(67%)</b>
0/1	0/0		<b>0/1</b>					
(0%)	(0%)		<b>(0%)</b>					
17	8		<b>25</b>					

	1st Set					2nd Set				
BECHRI Chiraz	0	*0	0	*0	0	*0	0	*1	1	*1
MARISTANY ZULETA Guiomar	*1	2	*3	4	*5	6	*1	1	*2	3

**LEGEND**

\* Server

RET Retired

W Winner

-



## Entry List by Event

As of TUE 28 JUN 2022

Rank	Name	CTRY	Seed
	BEKRAR Ines IBBOU Ines Feriel	ALG	
	ABDELSALAM Sandra EL SAYED Aya	EGY	
	BOUZAS MANEIRO Jessica MARISTANY ZULETA Guiomar	ESP	
	BRANCACCIO Nuria ZANTEDESCHI Aurora	ITA	
	EL AOUNI Aya KABBAJ Yasmine	MAR	
	CURMI Francesca GENOVESE Elaine	MLT	
	ALVES CAMPINO Mariana FONTE Maria Inês	POR	
	BECHRI Chiraz BEN HASSEN Feryel	TUN	
	ERAYIN Basak TURKMEN Doga	TUR	



## Team Medallists

Medal	CTRY	Name
GOLD	ESP - Spain	BOUZAS MANEIRO Jessica MARISTANY ZULETA Guiomar
SILVER	MLT - Malta	CURMI Francesca GENOVESE Elaine
BRONZE	ITA - Italy	BRANCACCIO Nuria ZANTEDESCHI Aurora



**Draw**  
As of SAT 2 JUL 2022 at 15:12

Rank	Round of 16	Seed	NOC	Quarter-finals	Semi-finals	Gold-medal Match		
	BRANCACCIO N./ZANTEDESCHI		ITA	BRANCACCIO N./ZANTEDESCHI A.	BRANCACCIO N./ZANTEDESCHI A. 6 - 4, 6 - 2	CURMI F./GENOVESE E. 3 - 6, 7 - 6(5), 0 - 0		
	ABDELSALAM S./EL SAYED A.		EGY	ABDELSALAM S./EL SAYED A.				
	BYE			BYE				
	CURMI F./GENOVESE E.		MLT	CURMI F./GENOVESE E.		CURMI F./GENOVESE E. 3 - 6, 7 - 6(5), 0 - 0		
	BYE			BYE				
	EL AOUNI A./KABBAJ Y.		MAR	EL AOUNI A./KABBAJ Y.	CURMI F./GENOVESE E. 7 - 6(1), 7 - 6(5)			
	BYE			BYE				
	BYE			BECHRI C./BEN HASSEN F.	BECHRI C./BEN HASSEN F. 6(6) - 7, 6 - 4, [10] - [6]	BOUZAS J./MARISTANY G. 6 - 4, 6 - 3		
	BECHRI C./BEN HASSEN F.		TUN	ERAYDIN B./TURKMEN D.				
	BYE			BYE				
	ERAYDIN B./TURKMEN D.		TUR	ERAYDIN B./TURKMEN D.				
	ALVES M./FONTE M.I.		POR	BEKRAR I./IBBOU I.	BOUZAS J./MARISTANY G. 7 - 5, 6 - 3			
	BEKRAR I./IBBOU I.		ALG	BEKRAR I./IBBOU I. 6 - 3, 6 - 2				
	BYE			BYE				
	BOUZAS J./MARISTANY G.		ESP	BOUZAS J./MARISTANY G.				
				BRANCACCIO N./ZANTEDESCHI	ITA		Gold Medal	
				BECHRI C./BEN HASSEN F.	TUN		BOUZAS MANEIRO/MARISTANY ZULETA 6 - 3, 6 - 2	
				BRANCACCIO N./ZANTEDESCHI	ITA	Bronze Medal		
				BECHRI C./BEN HASSEN F.	TUN	BRANCACCIO/ZANTEDESCHI		

**LEGEND**  
ALT Alternate      W/O Walk-Over



THU 30 JUN 2022

### Match Statistics - Double

	CURMI Francesca GENOVESE Elaine	MLT	3	2
W	<b>BOUZAS MANEIRO Jessica</b> <b>MARISTANY ZULETA Guiomar</b>	<b>ESP</b>	<b>6</b>	<b>6</b>
Match duration: 01h07min			34min	33min

Court 1

CURMI,F./GENOVESE,E.				BOUZAS,J./MARISTANY,G.				
1st Set	2nd Set	3rd Set	Total		1st Set	2nd Set	3rd Set	Total
0	0		0	Total aces	1	0		1
0	1		1	Double faults	0	0		0
24/27	19/25		43/52	1st serve	18/21	16/21		34/42
(89%)	(76%)		(83%)	Aces on 1st serve	(86%)	(76%)		(81%)
0	0		0	Points on 1st serve	1	0		1
15/24	7/19		22/43	2nd serve	14/18	11/16		25/34
(62%)	(37%)		(51%)	Aces on 2nd serve	(78%)	(69%)		(74%)
3/3	5/6		8/9	Points on 2nd serve	3/3	5/5		8/8
(100%)	(83%)		(89%)	Receive points won	(100%)	(100%)		(100%)
0	0		0	Break point convers.	0	0		0
1/3	3/6		4/9	Total points won	2/3	3/5		5/8
(33%)	(50%)		(44%)		(67%)	(60%)		(62%)
5/21	7/21		12/42		11/27	15/25		26/52
(24%)	(33%)		(29%)		(41%)	(60%)		(50%)
0/3	1/4		1/7		2/4	3/5		5/9
(0%)	(25%)		(14%)		(50%)	(60%)		(56%)
21	17		38		27	29		56

	1st Set									2nd Set								
CURMI/GENOVESE	*1	1	*2	2	*3	3	*3	3	*3	0	*1	1	*1	2	*2	2	*2	
BOUZAS MANEIRO/MARISTANY	0	*1	1	*2	2	*3	4	*5	6	*1	1	*2	3	*3	4	*5	6	

LEGEND

\* Server  
- -

RET Retired

W Winner



WED 29 JUN 2022

Match Statistics - Double

	BRANCACCIO Nuria ZANTEDESCHI Aurora	ITA	6	6(5)	0
W	CURMI Francesca GENOVESE Elaine	MLT	3	7	0
Match duration: 01h41min			42min	59min	0min

Court 1

BRANCACCIO,N./ZANTEDESCHI,A.					CURMI,F./GENOVESE,E.			
1st Set	2nd Set	3rd Set	Total		1st Set	2nd Set	3rd Set	Total
0	0	0	0	Total aces	0	0	0	0
0	1	0	1	Double faults	1	3	0	4
19/26	30/37	0/0	49/63	1st serve	19/32	43/49	0/0	62/81
(73%)	(81%)	(0%)	(78%)	Aces on 1st serve	(59%)	(88%)	(0%)	(77%)
0	0	0	0	Points on 1st serve	0	0	0	0
12/19	17/30	0/0	29/49	2nd serve	6/19	24/43	0/0	30/62
(63%)	(57%)	(0%)	(59%)	Aces on 2nd serve	(32%)	(56%)	(0%)	(48%)
7/7	6/7	0/0	13/14	Points on 2nd serve	12/13	3/6	0/0	15/19
(100%)	(86%)	(0%)	(93%)	Receive points won	(92%)	(50%)	(0%)	(79%)
0	0	0	0	Break point convers.	0	0	0	0
2/7	3/7	0/0	5/14	Total points won	6/13	2/6	0/0	8/19
(29%)	(43%)	(0%)	(36%)		(46%)	(33%)	(0%)	(42%)
20/32	23/49	0/0	43/81		12/26	17/37	0/0	29/63
(62%)	(47%)	(0%)	(53%)		(46%)	(46%)	(0%)	(46%)
4/8	2/8	0/0	6/16		2/3	2/2	0/0	4/5
(50%)	(25%)	(0%)	(38%)		(67%)	(100%)	(0%)	(80%)
34	43	0	77		24	43	0	67

	1st Set										2nd Set											
BRANCACCIO/ZANTEDESCHI	1	*1	1	*2	3	*4	5	*5	6	*0	1	*2	2	*3	4	*5	5	*5	5	*6	6	6(5)
CURMI/GENOVESE	*0	1	*2	2	*2	2	*2	3	*3	1	*1	1	*2	2	*2	2	*3	4	*5	5	*6	7

LEGEND

\* Server                                  RET Retired                                  W Winner  
- -





WED 29 JUN 2022

Match Statistics - Double

	BECHRI Chiraz BEN HASSEN Feryel	TUN	4	3
<b>W</b>	<b>BOUZAS MANEIRO Jessica</b> <b>MARISTANY ZULETA Guiomar</b>	<b>ESP</b>	<b>6</b>	<b>6</b>
Match duration: 01h23min			43min	40min

Court 3

BECHRI,C./BEN HASSEN,F.				BOUZAS,J./MARISTANY,G.				
1st Set	2nd Set	3rd Set	Total		1st Set	2nd Set	3rd Set	Total
3	0		<b>3</b>	Total aces	3	1		<b>4</b>
0	2		<b>2</b>	Double faults	1	1		<b>2</b>
15/25	24/36		<b>39/61</b>	1st serve	19/28	18/24		<b>37/52</b>
(60%)	(67%)		<b>(64%)</b>	Aces on 1st serve	3	1		<b>4</b>
3	0		<b>3</b>	Points on 1st serve	15/19	12/18		<b>27/37</b>
8/15	13/24		<b>21/39</b>	2nd serve	8/9	5/6		<b>13/15</b>
(53%)	(54%)		<b>(54%)</b>	Aces on 2nd serve	0	0		<b>0</b>
10/10	10/12		<b>20/22</b>	Points on 2nd serve	3/9	1/6		<b>4/15</b>
(100%)	(83%)		<b>(91%)</b>	Receive points won	10/25	21/36		<b>31/61</b>
0	0		<b>0</b>	Break point convers.	2/2	4/9		<b>6/11</b>
7/10	2/12		<b>9/22</b>	Total points won	28	34		<b>62</b>
(70%)	(17%)		<b>(41%)</b>					
10/28	11/24		<b>21/52</b>					
(36%)	(46%)		<b>(40%)</b>					
1/1	2/5		<b>3/6</b>					
(100%)	(40%)		<b>(50%)</b>					
25	26		<b>51</b>					

	1st Set										2nd Set									
BECHRI/BEN HASSEN	*1	1	*1	1	*2	3	*3	3	*4	4	*0	0	*0	1	*1	1	*2	3	*3	
BOUZAS MANEIRO/MARISTANY	0	*1	2	*3	3	*3	4	*5	5	*6	1	*2	3	*3	4	*5	5	*5	6	

LEGEND

\* Server

RET Retired

W Winner

-



## Number of Entries by Country

As of TUE 28 JUN 2022

Code	Country	Entries by Event				Number of Athletes		
		S	D	S	D	Men	Women	Total
ALB	Albania	1		2		1	2	3
ALG	Algeria	2	1	2	1	4	3	7
CYP	Cyprus	2	1			3	0	3
EGY	Egypt	2	1	3	1	2	4	6
ESP	Spain	2	1	2	1	2	2	4
GRE	Greece	2	1			2	0	2
ITA	Italy	2	1	2	1	2	2	4
KOS	Kosovo	1		1		1	1	2
MAR	Morocco	2	1	2	1	2	2	4
MLT	Malta	2	1	2	1	3	3	6
MON	Monaco	1				1	0	1
POR	Portugal	2	1	2	1	2	2	4
SLO	Slovenia	2	1	2	1	2	2	4
SMR	San Marino	1				1	0	1
TUN	Tunisia	2	1	2	1	2	2	4
TUR	Turkey	3	1	2	1	4	4	8
	Total: 16	29	12	24	10	34	29	63

### LEGEND

-  
-



ألعاب البحر الأبيض المتوسط  
MEDITERRANEAN GAMES  
JEUX MÉDITERRANÉENS  
du 25 juin au 06 juillet

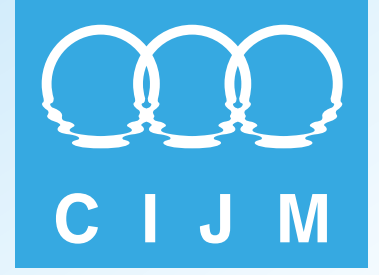

## Results Book



# Taekwondo



**TOSYALI  
ALGERIE**

Fer et Acier

سوناطراي



sonarach



microplus  
DATA PROCESSING & TIMING  
[www.microplustiming.com](http://www.microplustiming.com)



## Entry List by NOC

As of MON 04 JUL 2022 at 11:21

NOC	Name	Weight Category	Date of birth	Height
ALB - Albania				
	CANI Juirdo	Men -68kg	25 MAY 2018	
ALG - Algeria				
	ATAMANI Racha	Women -67kg	20 MAR 2001	
	BAATOUCHE Nada	Women -49kg	26 NOV 2003	
	KADI Assia	Women +67kg	06 DEC 2003	
	ZEGGANE Samia	Women -57kg	08 MAR 1996	
	ATTOUI Saidi	Men -58kg	06 APR 1996	
	BENDAIKHA Abdelmalek	Men +80kg	31 DEC 1994	
	GUETFAYA Islam	Men -80kg	24 JUL 2000	
	TEBIB Hani	Men -68kg	22 APR 2000	
BIH - Bosnia and Herzegovina				
	MAKAS Dzejla	Women -49kg	15 JUN 2004	
	SANDIC Zorana	Women -67kg	24 JUN 2004	
	HUSIC Nedzad	Men -80kg	15 SEP 2001	
	SEGEDIN Dinko	Men +80kg	21 DEC 1992	
CRO - Croatia				
	DUVANCIC Bruna	Women -49kg	28 OCT 2004	
	JELIC Matea	Women -67kg	23 DEC 1997	
	PETANJEK Nika	Women +67kg	06 NOV 2003	
	BRECIC Lovre	Men -68kg	16 AUG 1996	
	KANAET Toni	Men -80kg	04 SEP 1995	
	SAPINA Ivan	Men +80kg	17 NOV 1999	
	TESKERA Josip	Men -58kg	28 OCT 2001	
CYP - Cyprus				
	KOUTTOUKI Kyriaki	Women -49kg	12 SEP 1996	
	TEGGERI Markella	Women -57kg	07 SEP 2004	
	PILAVAKIS Ioannis	Men -68kg	09 AUG 1994	
EGY - Egypt				
	DARWISH Ashrakat	Women -57kg	08 AUG 2002	
	ELHOSSEINY Shahd	Women -49kg	25 SEP 2004	
	SHEHATA Aya	Women -67kg	16 FEB 2003	
	TOLBA Maisoun	Women +67kg	08 SEP 1997	
	BARAKAT Eyad	Men -68kg	01 JAN 2001	
	EISSA Seif	Men -80kg	15 JUN 1998	
	MANSOUR Mostafa	Men -58kg	04 FEB 2003	
	MOHAMED Ahmad	Men +80kg	05 AUG 2000	



## Entry List by NOC

As of MON 04 JUL 2022 at 11:21

NOC	Name	Weight Category	Date of birth	Height
ESP - Spain				
	CASTINEIRA ETCHEVERRIA Tania Maria	Women +67kg	15 JAN 2001	
	CASTRO BURGOS Cecilia	Women -67kg	21 JUN 1997	
	CEREZO IGLESIAS Adriana	Women -49kg	24 NOV 2003	
	MARTINEZ GARCIA Raul	Men +80kg	27 JUN 1991	
	PEREZ POLO Javier	Men -68kg	11 OCT 1996	
	QUESADA BARRERA Daniel	Men -80kg	26 SEP 1995	
	VICENTE YUNTA Adrian	Men -58kg	11 JUN 1999	
FRA - France				
	CARABIN Kanelya	Women -57kg	03 APR 2002	
	LAURIN Althea	Women +67kg	01 SEP 2001	
	WIET HENIN Magda	Women -67kg	31 AUG 1995	
	ALAPHILIPPE Souleyman	Men -68kg	30 JUN 2003	
	BOUZID SOUHLLI Ismael	Men -80kg	20 OCT 1997	
	ONANGA Herwan	Men -58kg	20 JUL 2004	
GRE - Greece				
	KALTEKI Faidra	Women -57kg	04 OCT 2002	
	MITSOPOULOU Athanasia	Women -67kg	10 FEB 1996	
	CHAMALIDIS Konstantinos	Men -68kg	16 APR 1996	
	TELIKOSTOGLOU Apostolos	Men -80kg	09 MAR 1995	
ITA - Italy				
	AL HALWANI Giada	Women -57kg	26 FEB 2002	
	GASPA Cristina	Women -67kg	22 FEB 1997	
	SMIRAGLIA Maristella	Women +67kg	29 MAR 1996	
	BALIVA Samuele	Men -80kg	01 APR 2002	
	BARETTA Dennis	Men -68kg	12 SEP 2004	
	BOTTA Roberto	Men +80kg	30 JUN 1996	
	FOTI Giuseppe	Men -58kg	25 APR 2003	
KOS - Kosovo				
	AZEMI Arber	Men -68kg	17 SEP 1995	
	BAJRA Arber	Men -80kg	17 JUL 1987	
LBA - Libya				
	BIRZEEQ Najimuldin	Men -68kg	02 AUG 2002	



## Entry List by NOC

As of MON 04 JUL 2022 at 11:21

NOC	Name	Weight Category	Date of birth	Height
<b>MAR - Morocco</b>				
	ABOUFARAS Fatima-Ezzahra	Women +67kg	28 FEB 2002	
	ELAASAL Nezha	Women -49kg	24 MAY 2005	
	LAARAJ Nada	Women -57kg	02 SEP 2000	
	SALIH Safia	Women -67kg	16 MAR 2001	
	BASSEL Ayoub	Men +80kg	29 SEP 1996	
	BOATRIS Youssef	Men -80kg	29 JUL 2001	
	LAKEHAL Omar	Men -58kg	05 JUN 1999	
	WASFI Abdelbasset	Men -68kg	02 MAR 1997	
<b>MKD - North Macedonia</b>				
	GEORGIEVSKA Anamarija	Women -67kg	03 MAY 2001	
	POPOVSKA Sanja	Women +67kg	31 MAY 2004	
	POPOVSKA Sanja	Women -57kg	31 MAY 2004	
	AVRAMOSKI Marko	Men -58kg	12 NOV 2002	
	DODEVSKI Filip	Men -80kg	17 JAN 2000	
	GEORGIEVSKI Dejan	Men +80kg	08 MAY 1999	
<b>MNE - Montenegro</b>				
	PERUNICIC Jelena	Women -49kg	26 JAN 2002	
	BECOVIC Zinedin	Men -68kg	10 JUL 1998	
<b>SLO - Slovenia</b>				
	DIVKOVIC Patrik	Men +80kg	04 JUN 1999	
	KOVACIC Lin	Men -68kg	25 JUL 2004	
	MOLJ Domen	Men -58kg	17 JAN 2004	
<b>SMR - San Marino</b>				
	CECCARONI Michele	Men -68kg	22 MAR 1992	
<b>SRB - Serbia</b>				
	BOZANIC Nadica	Women +67kg	13 MAR 2001	
	PERISIC Aleksandra	Women -67kg	02 JUL 2002	
	RADMILOVIC Aleksandra	Women -57kg	18 APR 1994	
	STANKOVIC Vanja	Women -49kg	24 MAR 1998	
	STANIC Novak	Men -68kg	07 JUL 2003	
	TAKOV Stefan	Men -80kg	06 AUG 2002	
<b>TUN - Tunisia</b>				
	DHAHRI Ikram	Women -49kg	07 JAN 1997	
	JENDOUBI Mohamed Khalil	Men -58kg	01 JUN 2002	
	KATOUSSE Firas	Men -80kg	06 SEP 1995	



### Entry List by NOC

As of MON 04 JUL 2022 at 11:21

NOC	Name	Weight Category	Date of birth	Height
TUR - Turkey				
	DINCEL Merve	Women -49kg	22 NOV 1999	
	EVCİ Mervenur	Women -67kg	20 AUG 1997	
	ILGÜN Hatice Kubra	Women -57kg	01 JAN 1993	
	KUS Nafia	Women +67kg	20 FEB 1995	
	ATESLI Emre Kutalmis	Men +80kg	01 JAN 2001	
	DAYIOGLU Omer Faruk	Men -58kg	20 JUL 1994	
	KARTAL Huseyin	Men -80kg	20 MAR 2000	
	RECBER Hakan	Men -68kg	17 AUG 1999	

Total number of entries : 95



### Medalists by Event

As of MON 04 JUL 2022 at 18:59

Event	Date	Medal	Name	NOC Code
Women +67kg	04 JUL 2022	Gold	KUS Nafia	TUR
		Silver	ABOUFARAS Fatima-Ezzahra	MAR
		Bronze	LAURIN Althea	FRA
		Bronze	PETANJEK Nika	CRO
Women -49kg	03 JUL 2022	Gold	DINCEL Merve	TUR
		Silver	CEREZO IGLESIAS Adriana	ESP
		Bronze	DUVANCIC Bruna	CRO
		Bronze	ELHOSSEINY Shahd	EGY
Women -57kg	03 JUL 2022	Gold	ILGUN Hatice Kubra	TUR
		Silver	DARWISH Ashrakat	EGY
		Bronze	AL HALWANI Giada	ITA
		Bronze	CARABIN Kanelya	FRA
Women -67kg	04 JUL 2022	Gold	JELIC Matea	CRO
		Silver	CASTRO BURGOS Cecilia	ESP
		Bronze	SHEHATA Aya	EGY
		Bronze	WIET HENIN Magda	FRA
Men +80kg	03 JUL 2022	Gold	SAPINA Ivan	CRO
		Silver	BASSEL Ayoub	MAR
		Bronze	BOTTA Roberto	ITA
		Bronze	GEORGIEVSKI Dejan	MKD
Men -58kg	04 JUL 2022	Gold	VICENTE YUNTA Adrian	ESP
		Silver	LAKEHAL Omar	MAR
		Bronze	DAYIOGLU Omer Faruk	TUR
		Bronze	MOLJ Domen	SLO
Men -68kg	03 JUL 2022	Gold	PEREZ POLO Javier	ESP
		Silver	RECBER Hakan	TUR
		Bronze	BRECIC Lovre	CRO
		Bronze	CHAMALIDIS Konstantinos	GRE
Men -80kg	04 JUL 2022	Gold	EISSA Seif	EGY
		Silver	QUESADA BARRERA Daniel	ESP
		Bronze	KATOUSSI Firas	TUN
		Bronze	TELIKOSTOGLU Apostolos	GRE





### Medal Standings

As of MON 04 JUL 2022 at 19:00

AFTER 8 OF 8 EVENTES

Rank	CDM Code	Men				Women				Total				Rank by Total
		G	S	B	Tot	G	S	B	Tot	G	S	B	Tot	
1	TUR - Turkey		1	1	2	3			3	3	1	1	5	=1
2	ESP - Spain	2	1		3		2		2	2	3		5	=1
3	CRO - Croatia	1		1	2	1		2	3	2		3	5	=1
4	EGY - Egypt	1			1		1	2	3	1	1	2	4	4
5	MAR - Morocco		2		2		1		1		3		3	=5
6	FRA - France							3	3			3	3	=5
7	GRE - Greece			2	2							2	2	=7
7	ITA - Italy			1	1			1	1			2	2	=7
9	MKD - North Macedonia			1	1							1	1	=9
9	SLO - Slovenia			1	1							1	1	=9
9	TUN - Tunisia			1	1							1	1	=9
	Total :	4	4	8	16	4	4	8	16	8	8	16	32	

LEGEND	
=	Equal sign indicates that two or more Nations share the same rank by total
<b>B</b>	Bronze
<b>G</b>	Gold
<b>S</b>	Silver
<b>Tot</b>	Total



### Entry List by Weight Category

As of MON 04 JUL 2022 at 11:22

Rank	NOC	Bib Number	Name	Date of birth	Height m / ft in
254	ALG	1344	BAATOUCHE Nada	26 NOV 2003	
456	BIH	6972	MAKAS Dzejla	15 JUN 2004	
27	CRO	504	DUVANCIC Bruna	28 OCT 2004	
29	CYP	11825	KOUTTOUKI Kyriaki	12 SEP 1996	
34	EGY	157	ELHOSSEINY Shahd	25 SEP 2004	
2	ESP	5342	CEREZO IGLESIAS Adriana	24 NOV 2003	
81	MAR	1023	ELAASAL Nezha	24 MAY 2005	
143	MNE	818	PERUNICIC Jelena	26 JAN 2002	
57	SRB	5907	STANKOVIC Vanja	24 MAR 1998	
54	TUN	13807	DHAHRI Ikram	07 JAN 1997	
5	TUR	10748	DINCEL Merve	22 NOV 1999	

Total Competitors : 11



**Draw Sheet**

As of MON 04 JUL 2022 at 18:57

Name	NOC Code	Quater Final	Semi Final	Final
5342 CEREZO IGLESIAS Adriana	ESP		CEREZO IGLESIAS A. PTG 26 : 4 (2 0:00)	
818 PERUNICIC Jelena	MNE	ELAASAL N. PTG 25 : 3 (3 1:05)		
1023 ELAASAL Nezha	MAR			CEREZO IGLESIAS A. PTF 5 : 1
157 ELHOSSEINY Shahd	EGY		ELHOSSEINY S. PTF 12 : 3	
1182 KOUTTOUKI Kyriaki	CYP			DINCEL M. PTF 7 : 1
504 DUVANCIC Bruna	CRO		DUVANCIC B. PTF 11 : 9	
6972 MAKAS Dzejla	BIH	DHAHRI I. PTF 16 : 2		
1380 DHAHRI Ikram	TUN			DINCEL M. PTF 7 : 5
5907 STANKOVIC Vanja	SRB	STANKOVIC V. PTF 32 : 15		
1344 BAATOUCHE Nada	ALG		DINCEL M. PTF 16 : 3	
1074 DINCEL Merve	TUR			

Classification		
1	DINCEL Merve	TUR
2	CEREZO IGLESIAS Adriana	ESP
3	DUVANCIC Bruna	CRO
3	ELHOSSEINY Shahd	EGY

LEGEND					
BYE	Win by Bye	PTG	Win by Point Gap	PTF	Win by Final Score



SUN 03 JUL 2022

### Medalists

As of MON 04 JUL 2022 at 18:58

Medal	Name	NOC
Gold	DINCEL Merve	TUR - Turkey
Silver	CEREZO IGLESIAS Adriana	ESP - Spain
Bronze	DUVANCIC Bruna	CRO - Croatia
Bronze	ELHOSSEINY Shahd	EGY - Egypt



### Entry List by Weight Category

As of MON 04 JUL 2022 at 11:22

Rank	NOC	Bib Number	Name	Date of birth	Height m / ft in
	ALG	12777	ZEGGANE Samia	08 MAR 1996	
208	CYP	11824	TEGGERI Markella	07 SEP 2004	
147	EGY	14292	DARWISH Ashrakat	08 AUG 2002	
107	FRA	8705	CARABIN Kanelya	03 APR 2002	
28	GRE	3303	KALTEKI Faidra	04 OCT 2002	
62	ITA	7679	AL HALWANI Giada	26 FEB 2002	
6	MAR	1041	LAARAJ Nada	02 SEP 2000	
	MKD	5255	POPOVSKA Sanja	31 MAY 2004	
36	SRB	5909	RADMILOVIC Aleksandra	18 APR 1994	
2	TUR	10749	ILGUN Hatice Kubra	01 JAN 1993	

Total Competitors : 10



**Draw Sheet**

As of MON 04 JUL 2022 at 18:57

Name	NOC Code	Quater Final	Semi Final	Final
1074 ILGUN Hatice Kubra	TUR		ILGUN H.K. PTG 22 : 2 (2 0:00)	ILGUN H.K. PTF 12 : 3
1277 ZEGGANE Samia	ALG	TEGGERI M. PTG 26 : 6 (3 0:55)		
1182 TEGGERI Markella	CYP			
7679 AL HALWANI Giada	ITA		AL HALWANI G. PTG 28 : 8 (3 1:00)	ILGUN H.K. PTF 28 : 7
5909 RADMILOVIC Aleksandra	SRB			
3303 KALTEKI Faidra	GRE		CARABIN K. PTF 14 : 12	
8705 CARABIN Kanelya	FRA			DARWISH A. PTF 21 : 13
1429 DARWISH Ashrakat	EGY	DARWISH A. PTF 7 : 5		
5255 POPOVSKA Sanja	MKD		DARWISH A. RSC 0 : 0, 7 : 6 (4 1:00)	
1041 LAARAJ Nada	MAR			

Classification	
1	ILGUN Hatice Kubra TUR
2	DARWISH Ashrakat EGY
3	AL HALWANI Giada ITA
3	CARABIN Kanelya FRA

LEGEND	
BYE	Win by Bye
PTG	Win by Point Gap
PTF	Win by Final Score
RSC	Win by Referee Stop Contest



SUN 03 JUL 2022

### Medalists

As of MON 04 JUL 2022 at 18:58

Medal	Name	NOC
Gold	ILGUN Hatice Kubra	TUR - Turkey
Silver	DARWISH Ashrakat	EGY - Egypt
Bronze	AL HALWANI Giada	ITA - Italy
Bronze	CARABIN Kanelya	FRA - France



### Entry List by Weight Category

As of MON 04 JUL 2022 at 11:22

Rank	NOC	Bib Number	Name	Date of birth	Height m / ft in
	ALG	13978	ATAMANI Racha	20 MAR 2001	
103	BIH	6954	SANDIC Zorana	24 JUN 2004	
1	CRO	502	JELIC Matea	23 DEC 1997	
45	EGY	146	SHEHATA Aya	16 FEB 2003	
8	ESP	5341	CASTRO BURGOS Cecilia	21 JUN 1997	
4	FRA	8691	WIET HENIN Magda	31 AUG 1995	
31	GRE	3304	MITSOPOULOU Athanasia	10 FEB 1996	
81	ITA	7680	GASPA Cristina	22 FEB 1997	
	MAR	1045	SALIH Safia	16 MAR 2001	
92	MKD	1528	GEORGIEVSKA Anamarija	03 MAY 2001	
26	SRB	5910	PERISIC Aleksandra	02 JUL 2002	
56	TUR	10753	EVCI Mervener	20 AUG 1997	

Total Competitors : 12





**Draw Sheet**

As of MON 04 JUL 2022 at 18:57

Name	NOC Code	Quater Final	Semi Final	Final
502 JELIC Matea	CRO		JELIC M. PTG 28 : 2 (2 0:00)	JELIC M. PTF 8 : 5
6954 SANDIC Zorana	BIH	GEORGIEVSKA A. PTF 13 : 5		
1528 GEORGIEVSKA Anamarija	MKD			
146 SHEHATA Aya	EGY		SHEHATA A. SUP 4 : 4	JELIC M. PTF 8 : 7
5910 PERISIC Aleksandra	SRB			
5341 CASTRO BURGOS Cecilia	ESP		CASTRO BURGOS C. PTF 19 : 5	
1397 ATAMANI Racha	ALG	EVCI M. PTF 17 : 6		
1075 EVCI Mervenur	TUR			CASTRO BURGOS C. PTF 19 : 15
7680 GASPA Cristina	ITA			
1045 SALIH Safia	MAR	SALIH S. PTF 4 : 3		
8691 WIET HENIN Magda	FRA		WIET HENIN M. PTG 21 : 1 (3 1:37)	

Classification	
1	JELIC Matea CRO
2	CASTRO BURGOS Cecilia ESP
3	SHEHATA Aya EGY
3	WIET HENIN Magda FRA

LEGEND	BYE	Win by Bye	PTF	Win by Final Score	PTG	Win by Point Gap	SUP	Win by Superiority
--------	-----	------------	-----	--------------------	-----	------------------	-----	--------------------



MON 04 JUL 2022

### Medalists

As of MON 04 JUL 2022 at 18:58

Medal	Name	NOC
Gold	JELIC Matea	CRO - Croatia
Silver	CASTRO BURGOS Cecilia	ESP - Spain
Bronze	SHEHATA Aya	EGY - Egypt
Bronze	WIET HENIN Magda	FRA - France



### Entry List by Weight Category

As of MON 04 JUL 2022 at 11:22

Rank	NOC	Bib Number	Name	Date of birth	Height m / ft in
	ALG	1351	KADI Assia	06 DEC 2003	
44	CRO	15661	PETANJEK Nika	06 NOV 2003	
	EGY	150	TOLBA Maisoun	08 SEP 1997	
28	ESP	5340	CASTINEIRA ETCHEVERRIA Tania Maria	15 JAN 2001	
4	FRA	8701	LAURIN Althea	01 SEP 2001	
31	ITA	3523	SMIRAGLIA Maristella	29 MAR 1996	
41	MAR	1021	ABOUFARAS Fatima-Ezzahra	28 FEB 2002	
	MKD	52550	POPOVSKA Sanja	31 MAY 2004	
	SRB	5912	BOZANIC Nadica	13 MAR 2001	
5	TUR	10754	KUS Nafia	20 FEB 1995	

Total Competitors : 10



**Draw Sheet**

As of MON 04 JUL 2022 at 18:57

Name	NOC Code	Quater Final	Semi Final	Final
8701 LAURIN Althea	FRA		LAURIN A. PTF 24 : 5	
5912 BOZANIC Nadica	SRB		BOZANIC N. PTF 10 : 3	
150 TOLBA Maisoun	EGY			ABOUFARAS F. PTF 9 : 6
1021 ABOUFARAS Fatima-Ezzahra	MAR		ABOUFARAS F. PTF 23 : 13	
3523 SMIRAGLIA Maristella	ITA			KUS N. PTF 5 : 0
5340 CASTINEIRA ETCHEVERRIA Tania Mari	ESP		PETANJEK N. PTF 7 : 4	
1566 PETANJEK Nika	CRO			KUS N. SUP 11 : 10
1351 KADI Assia	ALG		KUS N. PTG 20 : 0 (3 0:40)	
1075 KUS Nafia	TUR			

Classification		
1	KUS Nafia	TUR
2	ABOUFARAS Fatima-Ezzahra	MAR
3	LAURIN Althea	FRA
3	PETANJEK Nika	CRO

LEGEND		PTF		PTG		SUP	
BYE	Win by Bye	Win by Final Score		Win by Point Gap		Win by Superiority	



MON 04 JUL 2022

### Medalists

As of MON 04 JUL 2022 at 18:58

Medal	Name	NOC
Gold	KUS Nafia	TUR - Turkey
Silver	ABOUFARAS Fatima-Ezzahra	MAR - Morocco
Bronze	LAURIN Althea	FRA - France
Bronze	PETANJEK Nika	CRO - Croatia



### Entry List by Weight Category

As of MON 04 JUL 2022 at 11:22

Rank	NOC	Bib Number	Name	Date of birth	Height m / ft in
	ALG	6710	ATTOUI Saidi	06 APR 1996	
27	CRO	514	TESKERA Josip	28 OCT 2001	
81	EGY	137	MANSOUR Mostafa	04 FEB 2003	
4	ESP	5358	VICENTE YUNTA Adrian	11 JUN 1999	
249	FRA	8716	ONANGA Herwan	20 JUL 2004	
0	ITA	18110	FOTI Giuseppe	25 APR 2003	
25	MAR	1024	LAKEHAL Omar	05 JUN 1999	
757	MKD	5254	AVRAMOSKI Marko	12 NOV 2002	
72	SLO	12249	MOLJ Domen	17 JAN 2004	
5	TUN	13813	JENDOUBI Mohamed Khalil	01 JUN 2002	
84	TUR	10737	DAYIOGLU Omer Faruk	20 JUL 1994	

Total Competitors : 11



**Draw Sheet**

As of MON 04 JUL 2022 at 18:57

Name	NOC Code	Quater Final	Semi Final	Final
5358 VICENTE YUNTA Adrian	ESP		VICENTE YUNTA A. PTG 28 : 8 (2 0:00)	VICENTE YUNTA A. PTF 41 : 10
6710 ATTOUI Saidi	ALG	ATTOUI S. PTG 34 : 14 (3 0:41)		VICENTE YUNTA A. PTF 26 : 12
5254 AVRAMOSKI Marko	MKD			
137 MANSOUR Mostafa	EGY		MOLJ D. PTF 27 : 11	
1224 MOLJ Domen	SLO			
514 TESKERA Josip	CRO		DAYIOGLU O.F. RSC 50 : 5 (2 0:41)	
1073 DAYIOGLU Omer Faruk	TUR			LAKEHAL O. PTF 26 : 23
8716 ONANGA Herwan	FRA	ONANGA H. PTF 19 : 17		
1811 FOTI Giuseppe	ITA		LAKEHAL O. PTG 29 : 5 (2 0:00)	
1024 LAKEHAL Omar	MAR			

Classification		
1	VICENTE YUNTA Adrian	ESP
2	LAKEHAL Omar	MAR
3	DAYIOGLU Omer Faruk	TUR
	MOLJ Domen	SLO

LEGEND		PTG	Win by Point Gap	PTF	Win by Final Score	RSC	Win by Referee Stop Contest
BYE	Win by Bye						



MON 04 JUL 2022

### Medalists

As of MON 04 JUL 2022 at 18:58

Medal	Name	NOC
Gold	VICENTE YUNTA Adrian	ESP - Spain
Silver	LAKEHAL Omar	MAR - Morocco
Bronze	DAYIOGLU Omer Faruk	TUR - Turkey
Bronze	MOLJ Domen	SLO - Slovenia





## Entry List by Weight Category

As of MON 04 JUL 2022 at 11:22

Rank	NOC	Bib Number	Name	Date of birth	Height m / ft in
	ALB		CANI Juirdo	25 MAY 2018	
1417	ALG	1353	TEBIB Hani	22 APR 2000	
12	CRO	513	BRECIC Lovre	16 AUG 1996	
79	CYP	11823	PILAVAKIS Ioannis	09 AUG 1994	
67	EGY	142	BARAKAT Eyad	01 JAN 2001	
3	ESP	5353	PEREZ POLO Javier	11 OCT 1996	
	FRA	8695	ALAPHILIPPE Souleyman	30 JUN 2003	
17	GRE	3301	CHAMALIDIS Konstantinos	16 APR 1996	
71	ITA	25625	BARETTA Dennis	12 SEP 2004	
118	KOS	12285	AZEMI Arber	17 SEP 1995	
334	LBA	7394	BIRZEEQ Najimuldin	02 AUG 2002	
53	MAR	1028	WASFI Abdelbasset	02 MAR 1997	
64	MNE	816	BECOVIC Zinedin	10 JUL 1998	
113	SLO	12252	KOVACIC Lin	25 JUL 2004	
162	SMR	4986	CECCARONI Michele	22 MAR 1992	
76	SRB	5915	STANIC Novak	07 JUL 2003	
4	TUR	10739	RECBER Hakan	17 AUG 1999	

Total Competitors : 17



**Draw Sheet**

As of MON 04 JUL 2022 at 18:57

Name	NOC Code	Round of 16	Quarter Final	Semi Final	Final
5353 PEREZ POLO Javier	ESP		PEREZ POLO J. PTF 22 : 6		
8695 ALAPHILIPPE Souleyman	FRA				
1353 TEBIB Hani	ALG	ALAPHILIPPE S. PTF 27 : 22			
2562 BARETTA Dennis	ITA		BARETTA D. PTF 10 : 8	PEREZ POLO J. PTG 25 : 4 (3 0:25)	
142 BARAKAT Eyad	EGY				
1028 WASFI Abdelbasset	MAR				
1225 KOVACIC Lin	SLO		KOVACIC L. PTF 17 : 15		
1228 AZEMI Arber	KOS			CHAMALIDIS K. PTF 20 : 11	
3301 CHAMALIDIS Konstantinos	GRE		CHAMALIDIS K. PTF 18 : 8		
513 BRECIĆ Lovre	CRO				PEREZ POLO J. PTF 16 : 3
4986 CECCARONI Michele	SMR		BRECIĆ L. PTF 26 : 6		
1182 PILAVAKIS Ioannis	CYP			BRECIĆ L. PTG 42 : 10 (2 0:47)	
CANI Juirdo	ALB		CANI J. PTF 26 : 24		
816 BECOVIC Zinedin	MNE				RECBER H. PTF 36 : 33
5915 STANIC Novak	SRB		BECOVIC Z. PUN 42 : 18 (2 0:28)		
7394 BIRZEEQ Najimuldin	LBA			RECBER H. GDP 2:1, 33:33 (4 0:16)	
1073 RECBER Hakan	TUR		RECBER H. PTF 34 : 24		

Classification		
1	PEREZ POLO Javier	ESP
2	RECBER Hakan	TUR
3	BRECIĆ Lovre	CRO
3	CHAMALIDIS Konstantinos	GRE

LEGEND	PTF	PUN	PTG
BYE Win by Bye	Win by Final Score	Win by Punitive Declaration	Win by Point Gap
GDP Win by Golden Point			



SUN 03 JUL 2022

### Medalists

As of MON 04 JUL 2022 at 18:58

Medal	Name	NOC
Gold	PEREZ POLO Javier	ESP - Spain
Silver	RECBER Hakan	TUR - Turkey
Bronze	BRECIC Lovre	CRO - Croatia
Bronze	CHAMALIDIS Konstantinos	GRE - Greece



### Entry List by Weight Category

As of MON 04 JUL 2022 at 11:22

Rank	NOC	Bib Number	Name	Date of birth	Height m / ft in
	ALG	5724	GUETFAYA Islam	24 JUL 2000	
15	BIH	5812	HUSIC Nedzad	15 SEP 2001	
4	CRO	509	KANAET Toni	04 SEP 1995	
3	EGY	128	EISSA Seif	15 JUN 1998	
9	ESP	5354	QUESADA BARRERA Daniel	26 SEP 1995	
41	FRA	8689	BOUZID SOUHLLI Ismael	20 OCT 1997	
12	GRE	3302	TELIKOSTOGLU Apostolos	09 MAR 1995	
119	ITA	18111	BALIVA Samuele	01 APR 2002	
350	KOS	12286	BAJRA Arber	17 JUL 1987	
56	MAR	1030	BOATRIS Youssef	29 JUL 2001	
60	MKD	11185	DODEVSKI Filip	17 JAN 2000	
17	SRB	5914	TAKOV Stefan	06 AUG 2002	
	TUN	13806	KATOUSSI Firas	06 SEP 1995	
40	TUR	10742	KARTAL Huseyin	20 MAR 2000	

Total Competitors : 14



**Draw Sheet**

As of MON 04 JUL 2022 at 18:57

Name	NOC Code	Quarter Final	Semi Final	Final
128 EISSA Seif	EGY		EISSA S. PTF 13 : 9	
1030 BOATRIS Youssef	MAR	BOATRIS Y. PTF 33 : 31		
8689 BOUZID SOUHLLI Ismael	FRA			EISSA S. PTF 7 : 5
5812 HUSIC Nedzad	BIH	HUSIC N. PTG 28 : 3 (2 0:58)		
1228 BAJRA Arber	KOS		KATOUSSE F. PTF 22 : 4	
5724 GUETFAYA Islam	ALG	KATOUSSE F. PTG 26 : 5 (3 0:05)		
1380 KATOUSSE Firas	TUN			EISSA S. PTF 7 : 5
3302 TELIKOSTOGLU Apostolos	GRE		TELIKOSTOGLU A. PTF 5 : 1	
1811 BALIVA Samuele	ITA	TAKOV S. PTF 20 : 4		
5914 TAKOV Stefan	SRB			QUESADA BARRERA D. PTF 13 : 1
1074 KARTAL Huseyin	TUR	KARTAL H. PTF 24 : 13		
1118 DODEVSKI Filip	MKD		QUESADA BARRERA D. PTF 32 : 21	
5354 QUESADA BARRERA Daniel	ESP			

Classification		
1	EISSA Seif	EGY
2	QUESADA BARRERA Daniel	ESP
3	KATOUSSE Firas	TUN
3	TELIKOSTOGLU Apostolos	GRE

LEGEND					
BYE	Win by Bye	PTF	Win by Final Score	PTG	Win by Point Gap



MON 04 JUL 2022

### Medalists

As of MON 04 JUL 2022 at 18:58

Medal	Name	NOC
Gold	EISSA Seif	EGY - Egypt
Silver	QUESADA BARRERA Daniel	ESP - Spain
Bronze	KATOUSSI Firas	TUN - Tunisia
Bronze	TELIKOSTOGLU Apostolos	GRE - Greece

**Entry List by Weight Category**

As of MON 04 JUL 2022 at 11:22

Rank	NOC	Bib Number	Name	Date of birth	Height m / ft in
176	ALG	1347	BENDAIKHA Abdelmalek	31 DEC 1994	
36	BIH	6980	SEGEDIN Dinko	21 DEC 1992	
5	CRO	503	SAPINA Ivan	17 NOV 1999	
35	EGY	140	MOHAMED Ahmad	05 AUG 2000	
	ESP	5349	MARTINEZ GARCIA Raul	27 JUN 1991	
21	ITA	3521	BOTTA Roberto	30 JUN 1996	
31	MAR	1037	BASSEL Ayoub	29 SEP 1996	
8	MKD	1531	GEORGIEVSKI Dejan	08 MAY 1999	
28	SLO	12253	DIVKOVIC Patrik	04 JUN 1999	
11	TUR	10745	ATESLI Emre Kutalmis	01 JAN 2001	

Total Competitors : 10



**Draw Sheet**

As of MON 04 JUL 2022 at 18:57

Name	NOC Code	Quater Final	Semi Final	Final
503 SAPINA Ivan	CRO		SAPINA I. PTG 24 : 3 (3 1:26)	
1347 BENDAIKHA Abdelmalek	ALG			
6980 SEGEDIN Dinko	BIH	SEGEDIN D. PTF 18 : 6		
1225 DIVKOVIC Patrik	SLO			
3521 BOTTA Roberto	ITA		BOTTA R. PTF 10 : 2	
1074 ATESLI Emre Kutalmis	TUR			
1037 BASSEL Ayoub	MAR		BASSEL A. PTF 9 : 6	
140 MOHAMED Ahmad	EGY			
5349 MARTINEZ GARCIA Raul	ESP	MOHAMED A. PTF 15 : 8		
1531 GEORGIEVSKI Dejan	MKD		GEORGIEVSKI D. PTF 20 : 18	
				SAPINA I. PTF 18 : 15
				SAPINA I. PTF 35 : 25
				BASSEL A. RSC 0 : 0 (0 2:00)

Classification	
1	SAPINA Ivan CRO
2	BASSEL Ayoub MAR
3	BOTTA Roberto ITA
3	GEORGIEVSKI Dejan MKD

LEGEND	
BYE	Win by Bye
PTF	Win by Final Score
PTG	Win by Point Gap
RSC	Win by Referee Stop Contest





SUN 03 JUL 2022

### Medalists

As of MON 04 JUL 2022 at 18:58

Medal	Name	NOC
Gold	SAPINA Ivan	CRO - Croatia
Silver	BASSEL Ayoub	MAR - Morocco
Bronze	BOTTA Roberto	ITA - Italy
Bronze	GEORGIEVSKI Dejan	MKD - North Macedonia



ألعاب البحر الأبيض المتوسط  
MEDITERRANEAN GAMES  
JEUX MÉDITERRANÉENS  
du 25 juin au 06 juillet

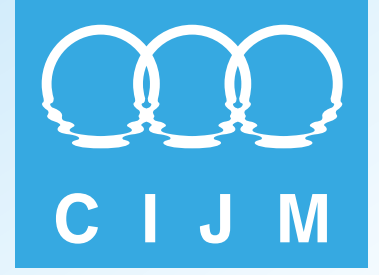

# Results Book



## Table Tennis



**TOSYALI  
ALGERIE**

Fer et Acier

سوناطراي



sonarach



microplus  
DATA PROCESSING & TIMING  
[www.microplustiming.com](http://www.microplustiming.com)



## Medallists by event

As of THU 30 JUN 2022 at 14:49

After 6 of 6 Events

Event Name	Date	Medal	Name	Ctry Code
Women Singles	THU 30 JUN 2022	GOLD	YANG Xiaoxin	MON
		SILVER	SHAO Jieni	POR
		BRONZE	XIAO YAO Maria	ESP
Men Singles	THU 30 JUN 2022	GOLD	ROBLES MARTINEZ Alvaro	ESP
		SILVER	ASSAR Omar	EGY
		BRONZE	FERREIRO GERALDO João Pedro	POR
Women Team	MON 27 JUN 2022	GOLD	ALHODABY Mariam GODA Hana MESHREF Dina	EGY
		SILVER	ARLIA Nicole PICCOLIN Giorgia STEFANOVA Nikoleta	ITA
		BRONZE	RODRIGUES DE MATOS Inês SERAMOTA PINTO Matilde SHAO Jieni	POR
Men Team	MON 27 JUN 2022	GOLD	HRIBAR Peter JORGIC Darko KOZUL Deni	SLO
		SILVER	ANDRADE SELGAS Joao Pedro CHEN Diao Jiahong FERREIRO GERALDO João Pedro	POR
		BRONZE	KONSTANTINOPOULOS Konstantinos SGOUROPOULOS Ioannis	GRE



## Medal Standings

As of WED 6 JUL 2022 at 14:51

After 6 of 6 Events

Rank	Country	Men				Women				Total				Rank by total
		G	S	B	Tot	G	S	B	Tot	G	S	B	Tot	
1	EGY - Egypt		1		1	1			1	1	1		2	= 2
2	ESP - Spain	1			1			1	1	1		1	2	= 2
3	MON - Monaco					1			1	1			1	= 4
3	SLO - Slovenia	1			1					1			1	= 4
5	POR - Portugal		1	1	2		1	1	2		2	2	4	1
6	ITA - Italy						1		1		1		1	= 4
7	GRE - Greece			1	1							1	1	= 4
	<b>Total:</b>	<b>2</b>	<b>2</b>	<b>2</b>	<b>6</b>	<b>2</b>	<b>2</b>	<b>2</b>	<b>6</b>	<b>4</b>	<b>4</b>	<b>4</b>	<b>12</b>	

### LEGEND

= Equal sign indicates that two or more **B** Bronze **G** Gold **S** Silver  
 Tot Total



## Competition Schedule

As of SAT 30 JUL 2022

### SINGLES

Event	Code	Final Rounds			Start Date	Finish Date
Women Singles Consolati	WC	QFL	SFL	FNL	28 JUN	30 JUN
Women Singles	WS	Q1	Q2	QFL	28 JUN	30 JUN
Men Singles Consolation	MC	R16	QFL	SFL	28 JUN	30 JUN
Men Singles	MS	Q1	Q2	QFL	28 JUN	30 JUN

Day	Date	Round	Session	Start time	Estimated Finish Time	T1	T2	T3	T4	T5	T6	T7	T8		
1	TUE 28 JUN	Qualification 1	5	10:00	10:20	MS-Q1	WS-Q1	MS-Q1	WS-Q1	MS-Q1	WS-Q1	MS-Q1	WS-Q1		
				10:45	11:05	WS-Q1	MS-Q1	WS-Q1	MS-Q1	WS-Q1	MS-Q1	MS-Q1	MS-Q1		
				11:30	11:50	MS-Q1	WS-Q1	MS-Q1	WS-Q1	MS-Q1	MS-Q1				
				15:00	15:20	MS-Q1	WS-Q1	WS-Q1	MS-Q1	WS-Q1	MS-Q1	WS-Q1	MS-Q1	WS-Q1	MS-Q1
				15:45	16:05	MS-Q1	WS-Q1	MS-Q1	WS-Q1	MS-Q1	WS-Q1	MS-Q1	WS-Q1	MS-Q1	
			6	16:30	16:50	WS-Q1	MS-Q1	WS-Q1	MS-Q1	MS-Q1	MS-Q1	MS-Q1	MS-Q1	MS-Q1	
				18:00	18:20	MS-Q1	WS-Q1	MS-Q1	WS-Q1	MS-Q1	WS-Q1	MS-Q1	WS-Q1	MS-Q1	WS-Q1
				18:45	19:05	WS-Q1	MS-Q1	WS-Q1	MS-Q1	WS-Q1	MS-Q1	WS-Q1	MS-Q1	MS-Q1	MS-Q1
				19:30	19:50	MS-Q1	WS-Q1	MS-Q1	WS-Q1			MS-Q1			
				19:50	20:10						MS-Q1				
2	WED 29 JUN	Round of 16 C.	7	10:00	10:20	MC-R16	MC-R16	MC-R16	MC-R16						
		Qualification 2		10:50	11:10	MS-Q2	WS-Q2	MS-Q2	WS-Q2	MS-Q2	WS-Q2	MS-Q2	WS-Q2		
		Quarter-finals	11:40	12:00	WS-Q2	MS-Q2	WS-Q2	MS-Q2	WS-Q2	MS-Q2	WS-Q2	MS-Q2	WS-Q2	MS-Q2	
			14:30	14:50	WC-QFL	MC-QFL	WC-QFL	MC-QFL	WC-QFL	MC-QFL	WC-QFL	MC-QFL	MC-QFL		
		Qualification 2	14:30	14:50	WC-QFL	MC-QFL	WC-QFL	MC-QFL	WC-QFL	MC-QFL	WC-QFL	MC-QFL	MC-QFL		
			15:20	15:40	MS-Q2	WS-Q2	WS-Q2	MS-Q2	WS-Q2	MS-Q2	WS-Q2	MS-Q2	WS-Q2	MS-Q2	
		Semi-finals	16:00	16:20	MS-Q2	WS-Q2	MS-Q2	WS-Q2	MS-Q2	WS-Q2	MS-Q2	WS-Q2	MS-Q2	WS-Q2	
			8	17:00	17:20	MC-SFL	WC-SFL	MC-SFL	WC-SFL						
		17:00		17:20	MC-SFL	WC-SFL	MC-SFL	WC-SFL							
		Qualification 2	17:20	17:40										MS-Q2	
			17:50	18:10	MS-Q2	WS-Q2	MS-Q2	WS-Q2	WS-Q2	WS-Q2	MS-Q2	WS-Q2	MS-Q2		
		Final C.	18:40	19:00	WS-Q2	MS-Q2	WS-Q2	MS-Q2	MS-Q2	MS-Q2	MS-Q2	MS-Q2	WS-Q2	WS-Q2	
			19:30	19:50	WC-FNL	MC-FNL									
19:30	19:50		WC-FNL	MC-FNL											
3	THU 30 JUN	Quarter-finals	9	10:00	10:20	WS-QFL	MS-QFL			WS-QFL	MS-QFL				
				10:50	11:10	MS-QFL	WS-QFL			MS-QFL	WS-QFL				
				14:30	14:50	WS-SFL	WS-SFL								
		Semi-finals	15:20	15:40	MS-SFL	MS-SFL									
			10	16:40	17:00	WS-FNL									
				17:30	17:50	MS-FNL									
Bronze medal Match															



## Competition Schedule

As of SAT 30 JUL 2022

		Gold medal Match		18:20	18:40	WS-FNL							
				19:10	19:30	MS-FNL							



## Competition Schedule

As of SAT 30 JUL 2022

### TEAM

Event	Code	Preliminary Round	Final Rounds			Start Date	Finish Date
			QFL	SFL	FNL		
Women Team	WT	Q1	QFL	SFL	FNL	26 JUN	30 JUN
Men Team	MT	Q1	QFL	SFL	FNL	26 JUN	30 JUN

Day	Date	Round	Session	Start time	Estimated Finish Time	T1	T2	T3	T4	T5	T6	T7	T8
1	SUN 26 JUN	Qualification 1	1	10:30	10:55	MT-Q1	WT-Q1	MT-Q1	WT-Q1	MT-Q1	WT-Q1	MT-Q1	
				15:00	15:25	WT-Q1	MT-Q1	WT-Q1	MT-Q1	WT-Q1	MT-Q1		
			2	18:00	18:25	MT-Q1	WT-Q1	MT-Q1	WT-Q1	MT-Q1	WT-Q1	MT-Q1	
2	MON 27 JUN	Quarter-finals	3	10:00	10:25	MT-QFL	WT-QFL	MT-QFL	WT-QFL	MT-QFL	MT-QFL		
		Semi-finals		14:30	14:55	WT-SFL	MT-SFL			WT-SFL	MT-SFL		
		Gold medal Match	4	18:00	18:25	MT-FNL	WT-FNL						
		Bronze medal Match		18:00	18:25				MT-FNL		WT-FNL		

#### LEGEND

FNL Final C.	FNL Gold medal Match	FNL Bronze medal Match	MC Singles Consolation	MS Singles
MT Team	Q1 Qualification 1	Q2 Qualification 2	QFL Quarter-finals	QFL Quarter-finals C.
WT Team	SFL Semi-finals	SFL Semi-finals C.	WC Singles Consolation	WS Singles



### Entry List by Country

As of THU 30 JUN 2022

Country	Gender	Name	Date of Birth	Event					
				MC	MS	MT	WC	WS	WT
ALG - Algeria	M	BOULOSSA Mehdi	15 MAY 1995	X	X	X			
	M	BOURIAH Larbi	24 FEB 1983	X		X			
	F	KESSACI Katia	28 FEB 1995				X	X	X
	M	KHEROUF Sami	15 NOV 1988	X	X	X			
	F	LOGHRAIBI Lynda	3 MAY 1997				X	X	X
	F	NASRI Malissa	20 OCT 2001				X		X
CYP - Cyprus	M	ELIA Iosif	9 NOV 2002	X		X			
	M	ELIA Sharpel	20 MAR 2006	X		X			
	F	MELETIE Foteini	5 JAN 2005				X	X	
	M	SAVVA Christos	22 DEC 2001	X	X				
	M	YIANGOU Marios	10 AUG 1991	X	X	X			
EGY - Egypt	F	ALHODABY Mariam	5 APR 2000				X		X
	M	ASSAR Omar	22 JUL 1991	X	X	X			
	M	ELBEIALY Mohamed	2 JUL 1988	X		X			
	F	GODA Hana	12 DEC 2007				X	X	X
	F	MESHREF Dina	10 MAR 1994				X	X	X
	M	SALEH Ahmed	14 NOV 1979	X	X	X			
ESP - Spain	M	CABALLERO CUELLAR Carlos	16 JUL 1997	X	X	X			
	M	MASIP NAVARRO Joan	29 SEP 1999	X		X			
	M	ROBLES MARTINEZ Alvaro	29 APR 1991	X	X	X			
	F	XIAO YAO Maria	19 MAY 1994				X	X	X
	F	ZHANG XU Sofia Xuan	14 SEP 1999				X	X	X
FRA - France	M	DE NODREST Leo Nicolas Michel	31 JUL 2000	X	X				
	F	LUTZ Camille Marie-Josée	17 JUL 2002				X	X	
	F	PAVADE Prithika	2 AUG 2004				X	X	
	M	REMBERT Bastien	31 MAY 2000	X	X				
GRE - Greece	M	KONSTANTINOPOULOS Konstantinos	7 JUN 1994	X	X	X			
	M	SGOUROPOULOS Ioannis	8 MAY 2000	X	X	X			
	F	TOLIOU Aikaterini	21 AUG 1995				X	X	
ITA - Italy	F	ARLIA Nicole	14 DEC 2005				X	X	X
	M	BOBOCICA Mihai Razvan	8 SEP 1986	X	X	X			
	F	PICCOLIN Giorgia	15 JAN 1996				X	X	X
	M	PICCOLIN Jordy	6 JUL 1997	X		X			
	F	STEFANOVA Nikoleta	22 APR 1984				X		X
	M	STOYANOV Niagol Ivanov	31 MAY 1987	X	X	X			
KOS - Kosovo	M	KARABAXHAK Fatih	3 MAY 2003	X	X				
	M	MAHMUTI Kreshnik	28 APR 2001	X	X				
LBA - Libya	M	ALAJAEBI Habeb	1 APR 2002	X	X	X			
	M	ELRAMALLI Hussin	7 OCT 2005	X	X	X			
MON - Monaco	F	YANG Xiaoxin	8 JAN 1988				X	X	
POR - Portugal	M	ANDRADE SELGAS Joao Pedro	29 AUG 1983	X	X	X			
	M	CHEN Diogo Jiahong	24 AUG 1996	X		X			





## Entry List by Country

As of THU 30 JUN 2022

Country	Gender	Name	Date of Birth	Event					
				MC	MS	MT	WC	WS	WT
	M	FERREIRO GERALDO João Pedro	29 SEP 1995	X	X	X			
	F	RODRIGUES DE MATOS Inês	5 OCT 2004				X	X	X
	F	SERAMOTA PINTO Matilde	6 JUN 2006				X		X
	F	SHAO Jieni	25 JAN 1994				X	X	X
SLO - Slovenia	M	HRIBAR Peter	12 NOV 1999	X	X	X			
	M	JORGIC Darko	30 JUL 1998	X		X			
	M	KOZUL Deni	18 MAR 1997	X	X	X			
	F	STRAZAR Katarina	3 MAY 2001				X	X	X
	F	TOFANT Ana	12 MAR 1999				X	X	X
	F	TOKIC Sara	1 SEP 2006				X		X
SMR - San Marino	M	GIARDI Federico	19 NOV 1999	X	X				
SRB - Serbia	M	GACEV Aleksa	1 OCT 1999	X		X			
	M	JEVTOVIC Marko	5 JAN 1987	X	X	X			
	F	JOKIC Tijana	28 MAY 2000				X		X
	M	LEVAJAC Dimitrije	14 AUG 2001	X	X	X			
	F	LUPULESKU Izabela	7 NOV 1999				X	X	X
	F	SURJAN Sabina	10 APR 2000				X	X	X
TUN - Tunisia	M	BEN ATTIA Youssef	23 JUN 2002	X	X	X			
	M	BOURASS Aboubaker	10 JAN 2001	X	X	X			
	F	GARCI Fadwa	6 FEB 2002				X	X	X
	F	ZOGLAMI Maram	16 FEB 2005				X	X	X
TUR - Turkiye	F	ALTINKAYA Sibel	1 FEB 1993				X	X	X
	M	GUNDUZ Ibrahim	18 OCT 1997	X	X	X			
	F	KULAKCEKEN Simay	18 JUN 1999				X	X	
	M	YIGENLER Abdullah Talha	8 APR 1999	X	X	X			
	F	YILMAZ Ozge	4 NOV 2002				X		X
	M	YILMAZ Tugay Sirzat	1 JAN 2001	X		X			

### LEGEND

F Women  
MT Team

M Men  
WC Singles Consolation

MC Singles Consolation  
WS Singles

MS Singles  
WT Team



## Entry List by event

As of THU 30 JUN 2022

Ctry	Name	Seed	Date of Birth
ALG - Algeria	KHEROUF Sami	187	15 NOV 1988
	BOULOUSA Mehdi	250	15 MAY 1995
CYP - Cyprus	SAVVA Christos		22 DEC 2001
	YIANGOU Marios		10 AUG 1991
EGY - Egypt	ASSAR Omar	20	22 JUL 1991
	SALEH Ahmed	58	14 NOV 1979
ESP - Spain	ROBLES MARTINEZ Alvaro	60	29 APR 1991
	CABALLERO CUELLAR Carlos	363	16 JUL 1997
FRA - France	DE NODREST Leo Nicolas Michel	166	31 JUL 2000
	REMBERT Bastien	182	31 MAY 2000
GRE - Greece	SGOUROPOULOS Ioannis	175	8 MAY 2000
	KONSTANTINOPOULOS Konstantinos		7 JUN 1994
ITA - Italy	STOYANOV Niaqol Ivanov	112	31 MAY 1987
	BOBOCICA Mihai Razvan	170	8 SEP 1986
KOS - Kosovo	KARABAXHAK Fatih		3 MAY 2003
	MAHMUTI Kreshnik		28 APR 2001
LBA - Libya	ALAJAEBI Habeb		1 APR 2002
	ELRAMALLI Hussin		7 OCT 2005
POR - Portugal	FERREIRO GERALDO João Pedro	41	29 SEP 1995
	ANDRADE SELGAS Joao Pedro		29 AUG 1983
SLO - Slovenia	KOZUL Deni	160	18 MAR 1997
	HRIBAR Peter		12 NOV 1999
SMR - San Marino	GIARDI Federico		19 NOV 1999
SRB - Serbia	LEVAJAC Dimitrije	196	14 AUG 2001
	JEVTOVIC Marko	566	5 JAN 1987
TUN - Tunisia	BOURASS Aboubaker	129	10 JAN 2001
	BEN ATTIA Youssef	245	23 JUN 2002
TUR - Turkiye	GUNDUZ Ibrahim	457	18 OCT 1997
	YIGENLER Abdullah Talha	464	8 APR 1999



## Medallists

As of WED 6 JUL 2022 at 12:47

Medal	Name	Country
GOLD	ROBLES MARTINEZ Alvaro	ESP - Spain
SILVER	ASSAR Omar	EGY - Egypt
BRONZE	FERREIRO GERALDO João Pedro	POR - Portugal



## Draw

Quarter-finals

Semi-finals

Gold medal Match

BOBOCICA M. ITA					
THU 30 JUN 10:50 (T5)					
ROBLES A. ESP					
		ROBLES A. ESP			
		4-3 (-5,-6,-5,8,6,9,8)			
		THU 30 JUN 15:20 (T1)			
		ROBLES A. ESP			
		4-2 (-6,8,-7,12,10,9)			
FERREIRO J. POR					
THU 30 JUN 10:00 (T2)					
SGOUROPOULOS I. GRE					
		FERREIRO J. POR			
		4-1 (8,10,6,-6,7)			
		THU 30 JUN 19:10 (T1)			
		ROBLES MARTINEZ Alvaro			
		4-2 (-6,8,5,-5,10,4)			Gold
REMBERT B. FRA					
THU 30 JUN 10:00 (T6)					
ASSAR O. EGY					
		ASSAR O. EGY			
		4-2 (-7,6,11,8,-10,4)			
		THU 30 JUN 15:20 (T2)			
		ASSAR O. EGY			
		4-3 (9,8,-9,8,-6,-7,10)			
		ASSAR Omar			Silver
STOYANOV N. ITA					
THU 30 JUN 10:50 (T1)					
BOULOSSA M. ALG					
		STOYANOV N. ITA			
		4-2 (10,-11,-6,9,9,5)			
		THU 30 JUN 17:30 (T1)			
		FERREIRO J. POR			
		STOYANOV N. ITA			
		4-0 (9,3,5,7)			
		FERREIRO GERALDO João Pedro			Bronze

Umpire's Signature \_\_\_\_\_

Umpire's Signature \_\_\_\_\_



## Draw

Quarter-finals

Semi-finals

Gold medal Match

BOBOCICA M. ITA

THU 30 JUN 10:50 (T5)

ROBLES A. ESP

FERREIRO J. POR

THU 30 JUN 10:00 (T2)

SGOUROPOULOS I. GRE

REMBERT B. FRA

THU 30 JUN 10:00 (T6)

ASSAR O. EGY

STOYANOV N. ITA

THU 30 JUN 10:50 (T1)

BOULOSSA M. ALG

Gold

Silver

Bronze medal Match

Bronze

Umpire's Signature \_\_\_\_\_

Umpire's Signature \_\_\_\_\_



## Pool standings

Match A						Matches				Games		Points	
Rank	Team	Ctry	EGY	ESP	TUN	Points	Played	Won	Lost	Won	Lost	For	Agst.
1	ASSAR Omar	EGY	---	4-1	4-0	4	2	2	0	8	1	101	60
2	CABALLERO CUELLAR Carlos	ESP	1-4	---	4-0	3	2	1	1	5	4	84	81
3	BEN ATTIA Youssef	TUN	0-4	0-4	---	2	2	0	2	0	8	44	88

Match B						Matches				Games		Points	
Rank	Team	Ctry	POR	TUR	ALG	Points	Played	Won	Lost	Won	Lost	For	Agst.
1	FERREIRO GERALDO João Pedro	POR	---	4-0	4-0	4	2	2	0	8	0	88	45
2	GUNDUZ Ibrahim	TUR	0-4	---	4-1	3	2	1	1	4	5	73	80
3	KHEROUF Sami	ALG	0-4	1-4	---	2	2	0	2	1	8	60	96

Match C						Matches				Games		Points	
Rank	Team	Ctry	EGY	TUR	SRB	Points	Played	Won	Lost	Won	Lost	For	Agst.
1	SALEH Ahmed	EGY	---	4-3	4-0	4	2	2	0	8	3	122	104
2	YIGENLER Abdullah Talha	TUR	3-4	---	4-1	3	2	1	1	7	5	139	129
3	LEVAJAC Dimitrije	SRB	0-4	1-4	---	2	2	0	2	1	8	77	105

Match D							Matches				Games		Points	
Rank	Team	Ctry	ESP	ALG	SLO	LBA	Points	Played	Won	Lost	Won	Lost	For	Agst.
1	ROBLES MARTINEZ Alvaro	ESP	---	4-1	4-1	4-0	6	3	3	0	12	2	150	79
2	BOULOUSA Mehdi	ALG	1-4	---	4-0	4-0	5	3	2	1	9	4	129	90
3	HRIBAR Peter	SLO	1-4	0-4	---	4-0	4	3	1	2	5	8	94	120
4	ALAJAEBI Habeb	LBA	0-4	0-4	0-4	---	3	3	0	3	0	12	48	132

Match E							Matches				Games		Points	
Rank	Team	Ctry	POR	CYP	FRA	LBA	Points	Played	Won	Lost	Won	Lost	For	Agst.
1	ANDRADE SELGAS Joao Pedro	POR	---	4-0	WO 0-0	4-0	6	3	3	0	8	0	88	35
2	SAVVA Christos	CYP	0-4	---	WO 0-0	4-0	5	3	2	1	4	4	65	59
3	DE NODREST Leo Nicolas Michel	FRA	0-0 WO	0-0 WO	---	0-0	2	3	0	2	0	0	0	0
4	ELRAMALLI Hussin	LBA	0-4	0-4	0-0	---	2	3	0	2	0	8	29	88

Match F							Matches				Games		Points	
Rank	Team	Ctry	FRA	ITA	SMR	KOS	Points	Played	Won	Lost	Won	Lost	For	Agst.
1	REMBERT Bastien	FRA	---	4-1	4-0	4-0	6	3	3	0	12	1	144	79
2	STOYANOV Niagol Ivanov	ITA	1-4	---	4-1	4-0	5	3	2	1	9	5	141	106
3	GIARDI Federico	SMR	0-4	1-4	---	4-2	4	3	1	2	5	10	123	150
4	KARABAXHAK Fatih	KOS	0-4	0-4	2-4	---	3	3	0	3	2	12	82	155

Match G							Matches				Games		Points	
Rank	Team	Ctry	GRE	SRB	TUN	KOS	Points	Played	Won	Lost	Won	Lost	For	Agst.



### Pool standings

1	SGOUROPOULOS Ioannis	GRE	---	4-3	4-0	4-0	6	3	3	0	12	3	157	105
2	JEVTOVIC Marko	SRB	3-4	---	4-0	4-0	5	3	2	1	11	4	157	109
3	BOURASS Aboubaker	TUN	0-4	0-4	---	4-0	4	3	1	2	4	8	87	115
4	MAHMUTI Kreshnik	KOS	0-4	0-4	0-4	---	3	3	0	3	0	12	62	134

Match H							Matches				Games		Points	
Rank	Team	Ctry	ITA	SLO	CYP	GRE	Points	Played	Won	Lost	Won	Lost	For	Agst.
1	BOBOCICA Mihai Razvan	ITA	---	3-4	4-1	1-0 ACC	5	3	2	1	7	5	118	101
2	KOZUL Deni	SLO	4-3	---	4-1	0-0	4	3	2	0	8	4	117	98
3	YIANGOU Marios	CYP	1-4	1-4	---	WO 0-0	4	3	1	2	2	8	70	106
4	KONSTANTINOPOULOS Konstantinos	GRE	ACC 0-1	0-0	0-0 WO	---	2	3	0	2	0	0	0	0



### Pool standings

Match A							Matches				Games		Points	
Rank	Team	Ctry	ITA	EGY	TUR	POR	Points	Played	Won	Lost	Won	Lost	For	Agst.
1	BOBOCICA Mihai Razvan	ITA	---	4-1	4-3	4-2	6	3	3	0	12	6	191	156
2	ASSAR Omar	EGY	1-4	---	4-2	WO 0-0	5	3	2	1	5	6	101	101
3	YIGENLER Abdullah Talha	TUR	3-4	2-4	---	WO 0-0	4	3	1	2	5	8	103	130
4	ANDRADE SELGAS Joao Pedro	POR	2-4	0-0 WO	0-0 WO	---	3	3	0	3	2	4	62	70

Match B							Matches				Games		Points	
Rank	Team	Ctry	ALG	POR	SLO	CYP	Points	Played	Won	Lost	Won	Lost	For	Agst.
1	BOULOUSA Mehdi	ALG	---	4-3	4-1	4-1	6	3	3	0	12	5	182	137
2	FERREIRO GERALDO Joao Pedro	POR	3-4	---	4-2	4-0	5	3	2	1	11	6	178	141
3	KOZUL Deni	SLO	1-4	2-4	---	4-0	4	3	1	2	7	8	133	143
4	SAVVA Christos	CYP	1-4	0-4	0-4	---	3	3	0	3	1	12	67	139

Match C							Matches				Games		Points	
Rank	Team	Ctry	GRE	ITA	EGY	ESP	Points	Played	Won	Lost	Won	Lost	For	Agst.
1	SGOUROPOULOS Ioannis	GRE	---	4-3	4-0	4-1	6	3	3	0	12	4	173	138
2	STOYANOV Niagol Ivanov	ITA	3-4	---	4-3	4-1	5	3	2	1	11	8	178	175
3	SALEH Ahmed	EGY	0-4	3-4	---	4-1	4	3	1	2	7	9	150	142
4	CABALLERO CUELLAR Carlos	ESP	1-4	1-4	1-4	---	3	3	0	3	3	12	110	156

Match D							Matches				Games		Points	
Rank	Team	Ctry	FRA	ESP	TUR	SRB	Points	Played	Won	Lost	Won	Lost	For	Agst.
1	REMBERT Bastien	FRA	---	4-1	4-3	4-2	6	3	3	0	12	6	173	150
2	ROBLES MARTINEZ Alvaro	ESP	1-4	---	4-1	4-0	5	3	2	1	9	5	137	117
3	GUNDUZ Ibrahim	TUR	3-4	1-4	---	4-3	4	3	1	2	8	11	180	187
4	JEVTOVIC Marko	SRB	2-4	0-4	3-4	---	3	3	0	3	5	12	149	185





## Entry List by event

As of THU 30 JUN 2022

Ctry	Name	Seed	Date of Birth
ALG - Algeria	KHEROUF Sami		15 NOV 1988
	BOURIAH Larbi		24 FEB 1983
	BOULOSSA Mehdi		15 MAY 1995
CYP - Cyprus	YANGOOU Marios		10 AUG 1991
	ELIA Iosif		9 NOV 2002
	ELIA Sharpel		20 MAR 2006
EGY - Egypt	SALEH Ahmed		14 NOV 1979
	ELBEIALY Mohamed		2 JUL 1988
	ASSAR Omar		22 JUL 1991
ESP - Spain	CABALLERO CUELLAR Carlos		16 JUL 1997
	MASIP NAVARRO Joan		29 SEP 1999
	ROBLES MARTINEZ Alvaro		29 APR 1991
GRE - Greece	SGOUROPOULOS Ioannis		8 MAY 2000
	KONSTANTINOPOULOS Konstantinos		7 JUN 1994
ITA - Italy	BOBOCICA Mihai Razvan		8 SEP 1986
	STOYANOV Niagol Ivanov		31 MAY 1987
	PICCOLIN Jordy		6 JUL 1997
LBA - Libya	ALAJAEBI Habeb		1 APR 2002
	ELRAMALLI Hussin		7 OCT 2005
POR - Portugal	CHEN Diogo Jiahong		24 AUG 1996
	ANDRADE SELGAS Joao Pedro		29 AUG 1983
	FERREIRO GERALDO João Pedro		29 SEP 1995
SLO - Slovenia	JORGIC Darko		30 JUL 1998
	KOZUL Deni		18 MAR 1997
	HRIBAR Peter		12 NOV 1999
SRB - Serbia	LEVAJAC Dimitrije		14 AUG 2001
	JEVTOVIC Marko		5 JAN 1987
	GACEV Aleksa		1 OCT 1999
TUN - Tunisia	BEN ATTIA Youssef		23 JUN 2002
	BOURASS Aboubaker		10 JAN 2001
TUR - Turkiye	YIGENLER Abdullah Talha		8 APR 1999
	GUNDUZ Ibrahim		18 OCT 1997
	YILMAZ Tugay Sirzat		1 JAN 2001



## Team Medallists

Medal	Ctry	Name
GOLD	SLO - Slovenia	HRIBAR Peter JORGIC Darko KOZUL Deni
SILVER	POR - Portugal	ANDRADE SELGAS Joao Pedro CHEN Diogo Jiahong FERREIRO GERALDO João Pedro
BRONZE	GRE - Greece	KONSTANTINOPOULOS Konstantinos SGOUROPOULOS Ioannis



## Draw

### Quarter-finals

### Semi-finals

### Gold medal Match

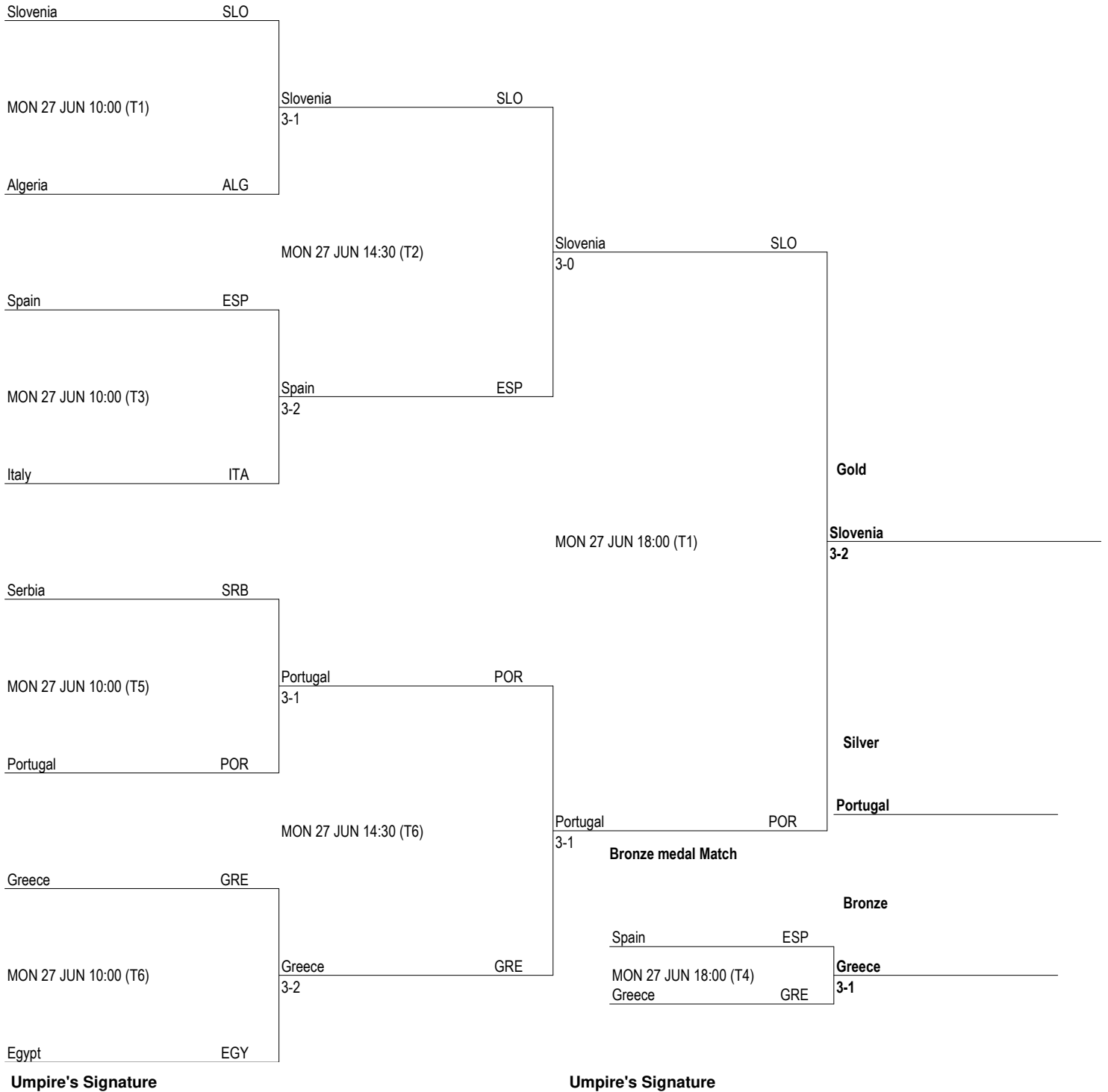



## Pool standings

Match A						Team Matches				Matches		Games		Points	
Rank	Team	Ctry	SLO	GRE	CYP	Points	Played	Won	Lost	Won	Lost	Won	Lost	For	Agst.
1	Slovenia	SLO	---	3-1	3-0	2	2	2	0	6	1	19	6	259	191
2	Greece	GRE	1-3	---	3-0	1	2	1	1	4	3	14	10	234	213
3	Cyprus	CYP	0-3	0-3	---	0	2	0	2	0	6	1	18	116	205

Match B						Team Matches				Matches		Games		Points	
Rank	Team	Ctry	EGY	ALG	LBA	Points	Played	Won	Lost	Won	Lost	Won	Lost	For	Agst.
1	Egypt	EGY	---	3-1	3-0	2	2	2	0	6	1	15	3	189	129
2	Algeria	ALG	1-3	---	3-0	1	2	1	1	4	3	12	10	204	174
3	Libya	LBA	0-3	0-3	---	0	2	0	2	0	6	1	15	80	170

Match C						Team Matches				Matches		Games		Points	
Rank	Team	Ctry	ITA	POR	TUR	Points	Played	Won	Lost	Won	Lost	Won	Lost	For	Agst.
1	Italy	ITA	---	3-1	3-2	4	2	2	0	6	3	19	14	325	307
2	Portugal	POR	1-3	---	3-2	3	2	1	1	4	5	21	10	317	255
3	Turkiye	TUR	2-3	2-3	---	2	2	0	2	4	6	11	27	320	400

Match D						Team Matches				Matches		Games		Points	
Rank	Team	Ctry	SRB	ESP	TUN	Points	Played	Won	Lost	Won	Lost	Won	Lost	For	Agst.
1	Serbia	SRB	---	3-2	3-0	2	2	2	0	6	2	17	10	254	228
2	Spain	ESP	2-3	---	3-0	1	2	1	1	5	3	18	11	276	236
3	Tunisia	TUN	0-3	0-3	---	0	2	0	2	0	6	3	17	149	215



## Pool standings

Match A						Team Matches				Matches		Games		Points	
Rank	Team	Ctry	SLO	GRE	CYP	Points	Played	Won	Lost	Won	Lost	Won	Lost	For	Agst.
1	Slovenia	SLO	---	3-1	3-0	2	2	2	0	6	1	19	6	259	191
2	Greece	GRE	1-3	---	3-0	1	2	1	1	4	3	14	10	234	213
3	Cyprus	CYP	0-3	0-3	---	0	2	0	2	0	6	1	18	116	205

Match B						Team Matches				Matches		Games		Points	
Rank	Team	Ctry	EGY	ALG	LBA	Points	Played	Won	Lost	Won	Lost	Won	Lost	For	Agst.
1	Egypt	EGY	---	3-1	3-0	2	2	2	0	6	1	15	3	189	129
2	Algeria	ALG	1-3	---	3-0	1	2	1	1	4	3	12	10	204	174
3	Libya	LBA	0-3	0-3	---	0	2	0	2	0	6	1	15	80	170

Match C						Team Matches				Matches		Games		Points	
Rank	Team	Ctry	ITA	POR	TUR	Points	Played	Won	Lost	Won	Lost	Won	Lost	For	Agst.
1	Italy	ITA	---	3-1	3-2	4	2	2	0	6	3	19	14	325	307
2	Portugal	POR	1-3	---	3-2	3	2	1	1	4	5	21	10	317	255
3	Turkiye	TUR	2-3	2-3	---	2	2	0	2	4	6	11	27	320	400

Match D						Team Matches				Matches		Games		Points	
Rank	Team	Ctry	SRB	ESP	TUN	Points	Played	Won	Lost	Won	Lost	Won	Lost	For	Agst.
1	Serbia	SRB	---	3-2	3-0	2	2	2	0	6	2	17	10	254	228
2	Spain	ESP	2-3	---	3-0	1	2	1	1	5	3	18	11	276	236
3	Tunisia	TUN	0-3	0-3	---	0	2	0	2	0	6	3	17	149	215



## Entry List by event

As of THU 30 JUN 2022

Ctry	Name	Seed	Date of Birth
ALG - Algeria	KESSACI Katia	171	28 FEB 1995
	LOGHRAIBI Lynda	197	3 MAY 1997
CYP - Cyprus	MELETIE Foteini		5 JAN 2005
EGY - Egypt	GODA Hana	33	12 DEC 2007
	MESHREF Dina	47	10 MAR 1994
ESP - Spain	XIAO YAO Maria	83	19 MAY 1994
	ZHANG XU Sofia Xuan	163	14 SEP 1999
FRA - France	PAVADE Prithika	102	2 AUG 2004
	LUTZ Camille Marie-Josee	103	17 JUL 2002
GRE - Greece	TOLIOU Aikaterini	187	21 AUG 1995
ITA - Italy	PICCOLIN Giorgia	74	15 JAN 1996
	ARLIA Nicole	123	14 DEC 2005
MON - Monaco	YANG Xiaoxin	12	8 JAN 1988
POR - Portugal	SHAO Jieni	51	25 JAN 1994
	RODRIGUES DE MATOS Inês	252	5 OCT 2004
SLO - Slovenia	TOFANT Ana	178	12 MAR 1999
	STRAZAR Katarina	201	3 MAY 2001
SRB - Serbia	LUPULESKU Izabela	105	7 NOV 1999
	SURJAN Sabina	122	10 APR 2000
TUN - Tunisia	GARCI Fadwa	136	6 FEB 2002
	ZOGLAMI Maram	137	16 FEB 2005
TUR - Turkiye	ALTINKAYA Sibel	155	1 FEB 1993
	KULAKCEKEN Simay	354	18 JUN 1999



## Medallists

As of WED 6 JUL 2022 at 12:54

Medal	Name	Country
GOLD	YANG Xiaoxin	MON - Monaco
SILVER	SHAO Jieni	POR - Portugal
BRONZE	XIAO YAO Maria	ESP - Spain



## Draw

Quarter-finals

Semi-finals

Gold medal Match

<p>YANG X. MON</p> <p>THU 30 JUN 10:00 (T1)</p> <p>ALTINKAYA S. TUR</p>	<p>YANG X. MON</p> <p>4-0 (5,3,9,7)</p>		
<p>TOLIOU A. GRE</p> <p>THU 30 JUN 10:50 (T6)</p> <p>XIAO YAO M. ESP</p>	<p>THU 30 JUN 14:30 (T2)</p> <p>XIAO YAO M. ESP</p> <p>4-2 (10,8,-10,5,-4,6)</p>	<p>YANG X. MON</p> <p>4-0 (5,7,6,7)</p>	
<p>LUPULESKU I. SRB</p> <p>THU 30 JUN 10:00 (T5)</p> <p>SHAO J. POR</p>	<p>SHAO J. POR</p> <p>4-1 (4,-1,9,5,6)</p>	<p>THU 30 JUN 18:20 (T1)</p> <p>YANG Xiaoxin</p> <p>4-0 (4,8,7,8)</p>	<p>Gold</p>
<p>LUTZ C. FRA</p> <p>THU 30 JUN 10:50 (T2)</p> <p>GODA H. EGY</p>	<p>THU 30 JUN 14:30 (T1)</p> <p>LUTZ C. FRA</p> <p>4-0 (6,9,9,8)</p>	<p>SHAO J. POR</p> <p>4-2 (-8,8,-7,7,6,8)</p> <p>Bronze medal Match</p>	<p>Silver</p> <p>SHAO Jieni</p>
		<p>XIAO YAO M. ESP</p> <p>THU 30 JUN 16:40 (T1)</p> <p>LUTZ C. FRA</p>	<p>Bronze</p> <p>XIAO YAO Maria</p> <p>4-3 (8,-4,11,-3,-11,6,8)</p>

Umpire's Signature \_\_\_\_\_

Umpire's Signature \_\_\_\_\_





## Draw

Quarter-finals

Semi-finals

Gold medal Match

YANG X. MON

THU 30 JUN 10:00 (T1)

ALTINKAYA S. TUR

TOLIOU A. GRE

THU 30 JUN 10:50 (T6)

XIAO YAO M. ESP

LUPULESKU I. SRB

THU 30 JUN 10:00 (T5)

SHAO J. POR

LUTZ C. FRA

THU 30 JUN 10:50 (T2)

GODA H. EGY

Gold

Silver

Bronze medal Match

Bronze

Umpire's Signature \_\_\_\_\_

Umpire's Signature \_\_\_\_\_



### Pool standings

Match A						Matches				Games		Points	
Rank	Team	Ctry	MON	TUN	ALG	Points	Played	Won	Lost	Won	Lost	For	Agst.
1	YANG Xiaoxin	MON	---	4-0	4-0	4	2	2	0	8	0	88	38
2	GARCI Fadwa	TUN	0-4	---	4-0	3	2	1	1	4	4	66	72
3	KESSACI Katia	ALG	0-4	0-4	---	2	2	0	2	0	8	45	89

Match B						Matches				Games		Points	
Rank	Team	Ctry	EGY	SLO	TUN	Points	Played	Won	Lost	Won	Lost	For	Agst.
1	GODA Hana	EGY	---	4-0	4-0	4	2	2	0	8	0	99	62
2	TOFANT Ana	SLO	0-4	---	4-0	3	2	1	1	4	4	80	73
3	ZOGLAMI Maram	TUN	0-4	0-4	---	2	2	0	2	0	8	49	93

Match C						Matches				Games		Points	
Rank	Team	Ctry	TUR	GRE	EGY	Points	Played	Won	Lost	Won	Lost	For	Agst.
1	ALTINKAYA Sibel	TUR	---	4-1	2-4	3	2	1	1	6	5	96	83
2	TOLIOU Aikaterini	GRE	1-4	---	4-1	3	2	1	1	5	5	87	100
3	MESHREF Dina	EGY	4-2	1-4	---	3	2	1	1	5	6	108	108

Match D						Matches				Games		Points	
Rank	Team	Ctry	POR	ESP	ITA	Points	Played	Won	Lost	Won	Lost	For	Agst.
1	SHAO Jieni	POR	---	4-1	4-0	4	2	2	0	8	1	94	60
2	ZHANG XU Sofia Xuan	ESP	1-4	---	4-0	3	2	1	1	5	4	79	79
3	ARLIA Nicole	ITA	0-4	0-4	---	2	2	0	2	0	8	54	88

Match E						Matches				Games		Points	
Rank	Team	Ctry	ITA	FRA	SLO	Points	Played	Won	Lost	Won	Lost	For	Agst.
1	PICCOLIN Giorgia	ITA	---	4-1	4-2	4	2	2	0	8	3	107	97
2	LUTZ Camille Marie-Josée	FRA	1-4	---	4-1	3	2	1	1	5	5	96	91
3	STRAZAR Katarina	SLO	2-4	1-4	---	2	2	0	2	3	8	92	107

Match F							Matches				Games		Points	
Rank	Team	Ctry	SRB	ESP	POR	CYP	Points	Played	Won	Lost	Won	Lost	For	Agst.
1	SURJAN Sabina	SRB	---	4-2	4-1	4-0	6	3	3	0	12	3	149	112
2	XIAO YAO Maria	ESP	2-4	---	4-0	4-0	5	3	2	1	10	4	146	103
3	RODRIGUES DE MATOS Inês	POR	1-4	0-4	---	4-1	4	3	1	2	5	9	117	130
4	MELETIE Foteini	CYP	0-4	0-4	1-4	---	3	3	0	3	1	12	73	140

Match G							Matches				Games		Points	
Rank	Team	Ctry	FRA	SRB	TUR	ALG	Points	Played	Won	Lost	Won	Lost	For	Agst.
1	PAVADE Prithika	FRA	---	4-0	4-2	4-1	6	3	3	0	12	3	157	110
2	LUPULESKU Izabela	SRB	0-4	---	4-2	4-1	5	3	2	1	8	7	146	129



### Pool standings

3	KULAKCEKEN Simay	TUR	2-4	2-4	---	4-3	4	3	1	2	8	11	164	173
4	LOGHRAIBI Lynda	ALG	1-4	1-4	3-4	---	3	3	0	3	5	12	124	179



## Pool standings

Match A							Matches				Games		Points	
Rank	Team	Ctry	MON	FRA	TUR	POR	Points	Played	Won	Lost	Won	Lost	For	Agst.
1	YANG Xiaoxin	MON	---	4-2	4-0	4-0	6	3	3	0	12	2	154	106
2	LUTZ Camille Marie-Josee	FRA	2-4	---	4-2	4-0	5	3	2	1	10	6	163	159
3	KULAKCEKEN Simay	TUR	0-4	2-4	---	4-3	4	3	1	2	6	11	158	179
4	RODRIGUES DE MATOS Inés	POR	0-4	0-4	3-4	---	3	3	0	3	3	12	131	162

Match B							Matches				Games		Points	
Rank	Team	Ctry	EGY	GRE	SRB	TUN	Points	Played	Won	Lost	Won	Lost	For	Agst.
1	GODA Hana	EGY	---	2-4	4-1	4-0	5	3	2	1	10	5	152	122
2	TOLIOU Aikaterini	GRE	4-2	---	3-4	4-0	5	3	2	1	11	6	161	131
3	SURJAN Sabina	SRB	1-4	4-3	---	4-0	5	3	2	1	9	7	154	139
4	GARCI Fadwa	TUN	0-4	0-4	0-4	---	3	3	0	3	0	12	60	135

Match C							Matches				Games		Points	
Rank	Team	Ctry	SRB	TUR	ESP	ITA	Points	Played	Won	Lost	Won	Lost	For	Agst.
1	LUPULESKU Izabela	SRB	---	4-0	4-1	WO 0-0	6	3	3	0	8	1	95	64
2	ALTINKAYA Sibel	TUR	0-4	---	4-1	WO 0-0	5	3	2	1	4	5	78	86
3	ZHANG XU Sofia Xuan	ESP	1-4	1-4	---	4-2	4	3	1	2	6	10	146	155
4	PICCOLIN Giorgia	ITA	0-0 WO	0-0 WO	2-4	---	3	3	0	3	2	4	49	63

Match D							Matches				Games		Points	
Rank	Team	Ctry	ESP	POR	FRA	SLO	Points	Played	Won	Lost	Won	Lost	For	Agst.
1	XIAO YAO Maria	ESP	---	4-2	4-1	4-0	6	3	3	0	12	3	150	117
2	SHAO Jieni	POR	2-4	---	4-1	4-0	5	3	2	1	10	5	148	115
3	PAVADE Prithika	FRA	1-4	1-4	---	4-0	4	3	1	2	6	8	124	119
4	TOFANT Ana	SLO	0-4	0-4	0-4	---	3	3	0	3	0	12	62	133



## Entry List by event

As of THU 30 JUN 2022

Ctry	Name	Seed	Date of Birth
ALG - Algeria	KESSACI Katia		28 FEB 1995
	LOGHRAIBI Lynda		3 MAY 1997
	NASRI Malissa		20 OCT 2001
EGY - Egypt	MESHREF Dina		10 MAR 1994
	GODA Hana		12 DEC 2007
	ALHODABY Mariam		5 APR 2000
ESP - Spain	XIAO YAO Maria		19 MAY 1994
	ZHANG XU Sofia Xuan		14 SEP 1999
ITA - Italy	STEFANOVA Nikoleta		22 APR 1984
	PICCOLIN Giorgia		15 JAN 1996
	ARLIA Nicole		14 DEC 2005
POR - Portugal	RODRIGUES DE MATOS Inês		5 OCT 2004
	SERAMOTA PINTO Matilde		6 JUN 2006
	SHAO Jieni		25 JAN 1994
SLO - Slovenia	TOFANT Ana		12 MAR 1999
	STRAZAR Katarina		3 MAY 2001
	TOKIC Sara		1 SEP 2006
SRB - Serbia	SURJAN Sabina		10 APR 2000
	LUPULESKU Izabela		7 NOV 1999
	JOKIC Tijana		28 MAY 2000
TUN - Tunisia	GARCI Fadwa		6 FEB 2002
	ZOGLAMI Maram		16 FEB 2005
TUR - Turkiye	ALTINKAYA Sibel		1 FEB 1993
	YILMAZ Ozge		4 NOV 2002



## Team Medallists

Medal	Ctry	Name
GOLD	EGY - Egypt	ALHODABY Mariam GODA Hana MESHREF Dina
SILVER	ITA - Italy	ARLIA Nicole PICCOLIN Giorgia STEFANOVA Nikoleta
BRONZE	POR - Portugal	RODRIGUES DE MATOS Inês SERAMOTA PINTO Matilde SHAO Jieni



## Draw

Quarter-finals

Semi-finals

Gold medal Match

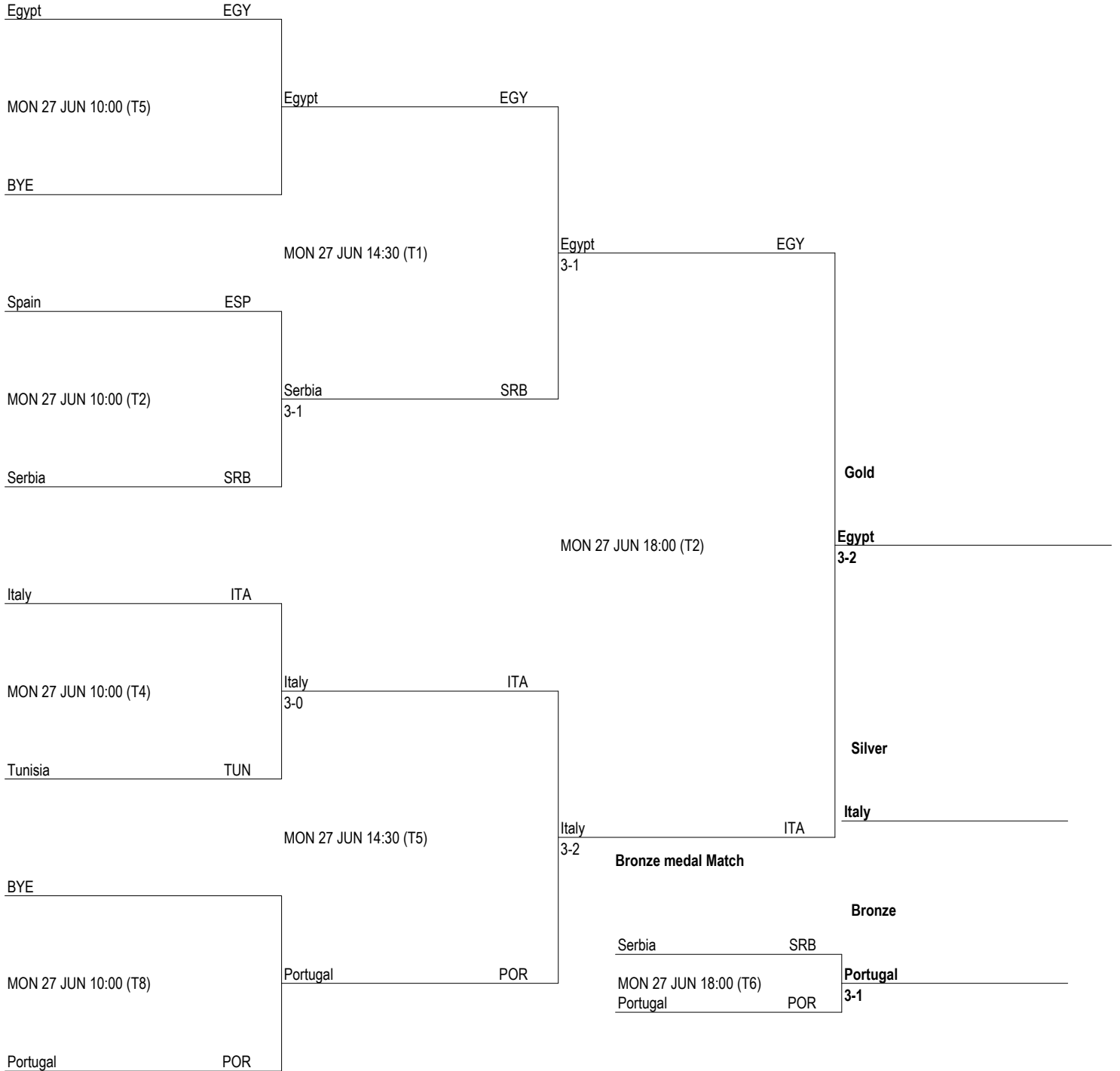

Umpire's Signature \_\_\_\_\_

Umpire's Signature \_\_\_\_\_



## Pool standings

Match A						Team Matches				Matches		Games		Points	
Rank	Team	Ctry	EGY	TUN	ALG	Points	Played	Won	Lost	Won	Lost	Won	Lost	For	Agst.
1	Egypt	EGY	---	3-0	3-0	4	2	2	0	6	0	18	2	215	104
2	Tunisia	TUN	0-3	---	3-1	3	2	1	1	3	4	10	16	217	259
3	Algeria	ALG	0-3	1-3	---	2	2	0	2	1	6	8	18	201	270

Match B						Team Matches				Matches		Games		Points	
Rank	Team	Ctry	POR	ESP	SLO	Points	Played	Won	Lost	Won	Lost	Won	Lost	For	Agst.
1	Portugal	POR	---	3-2	3-0	4	2	2	0	6	2	17	9	256	240
2	Spain	ESP	2-3	---	3-0	3	2	1	1	5	3	15	11	245	219
3	Slovenia	SLO	0-3	0-3	---	2	2	0	2	0	6	4	16	178	220

Match C						Team Matches				Matches		Games		Points	
Rank	Team	Ctry	ITA	SRB	TUR	Points	Played	Won	Lost	Won	Lost	Won	Lost	For	Agst.
1	Italy	ITA	---	3-1	3-1	4	2	2	0	6	2	21	14	341	312
2	Serbia	SRB	1-3	---	3-2	3	2	1	1	4	5	19	22	374	378
3	Turkey	TUR	1-3	2-3	---	2	2	0	2	3	6	17	21	327	352





ألعاب البحر الأبيض المتوسط  
MEDITERRANEAN GAMES  
JEUX MÉDITERRANÉENS  
du 25 juin au 06 juillet

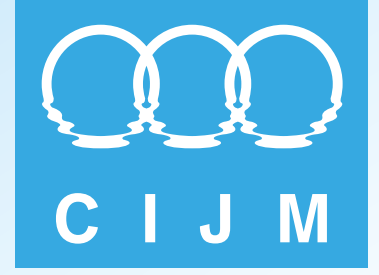

# Results Book



## Volleyball



**TOSYALI  
ALGERIE**

Fer et Acier

سوناطراي



sonarach



microplus  
DATA PROCESSING & TIMING  
[www.microplustiming.com](http://www.microplustiming.com)



## Competition Schedule

As of SAT 2 JUL 2022 at 23:57

Date	Start Time	Estimated Finish Time	Teams	Gender	Phase	Game No.	Venue
SUN 26 JUN 2022	8:30	10:00	EGY - ITA	Men	Preliminary Group A	1	Palais Sports Hammou Boutlélis
	9:00	10:30	FRA - CRO	Women	Preliminary Group A	2	Salle Bir El Djir
	12:00	13:30	TUN - SRB	Men	Preliminary Group C	3	Palais Sports Hammou Boutlélis
	12:00	13:30	EGY - MKD	Women	Preliminary Group B	4	Salle Bir El Djir
	15:00	16:30	CRO - ESP	Men	Preliminary Group C	5	Palais Sports Hammou Boutlélis
	15:00	16:30	TUN - GRE	Women	Preliminary Group B	6	Salle Bir El Djir
	18:00	19:30	TUR - ALG	Men	Preliminary Group B	7	Palais Sports Hammou Boutlélis
	18:00	19:30	ITA - ESP	Women	Preliminary Group C	8	Salle Bir El Djir
	21:00	22:30	FRA - GRE	Men	Preliminary Group B	9	Palais Sports Hammou Boutlélis
	21:00	22:30	ALG - TUR	Women	Preliminary Group C	10	Salle Bir El Djir
MON 27 JUN	9:00	10:30	MKD - EGY	Men	Preliminary Group A	11	Palais Sports Hammou Boutlélis
	9:00	10:30	SRB - FRA	Women	Preliminary Group A	12	Salle Bir El Djir
	12:00	13:30	SRB - CRO	Men	Preliminary Group C	13	Palais Sports Hammou Boutlélis
	12:00	13:30	MKD - TUN	Women	Preliminary Group B	14	Salle Bir El Djir
	15:00	16:30	ESP - TUN	Men	Preliminary Group C	15	Palais Sports Hammou Boutlélis
	15:00	16:30	GRE - EGY	Women	Preliminary Group B	16	Salle Bir El Djir
	18:00	19:30	ALG - FRA	Men	Preliminary Group B	17	Palais Sports Hammou Boutlélis
	18:00	19:30	TUR - ITA	Women	Preliminary Group C	18	Salle Bir El Djir
	21:00	22:30	GRE - TUR	Men	Preliminary Group B	19	Palais Sports Hammou Boutlélis
	21:00	22:30	ESP - ALG	Women	Preliminary Group C	20	Salle Bir El Djir
TUE 28 JUN 2022	9:00	10:30	ITA - MKD	Men	Preliminary Group A	21	Palais Sports Hammou Boutlélis
	9:00	10:30	CRO - SRB	Women	Preliminary Group A	22	Salle Bir El Djir
	12:00	13:30	ESP - SRB	Men	Preliminary Group C	23	Palais Sports Hammou Boutlélis
	12:00	13:30	GRE - MKD	Women	Preliminary Group B	24	Salle Bir El Djir
	15:00	16:30	TUN - CRO	Men	Preliminary Group C	25	Palais Sports Hammou Boutlélis
	15:00	16:30	EGY - TUN	Women	Preliminary Group B	26	Salle Bir El Djir
	18:00	19:30	GRE - ALG	Men	Preliminary Group B	27	Palais Sports Hammou Boutlélis
	18:00	19:30	TUR - ESP	Women	Preliminary Group C	28	Salle Bir El Djir
	21:00	22:30	TUR - FRA	Men	Preliminary Group B	29	Palais Sports Hammou Boutlélis
	21:00	22:30	ITA - ALG	Women	Preliminary Group C	30	Salle Bir El Djir
THU 30 JUN 2022	10:00	11:30	ITA - TUR	Men	Quarter-finals	31	Palais Sports Hammou Boutlélis
	10:00	11:30	SRB - EGY	Women	Quarter-finals	32	Salle Bir El Djir
	13:00	14:30	EGY - ESP	Men	Quarter-finals	33	Palais Sports Hammou Boutlélis
	13:00	14:30	CRO - ITA	Women	Quarter-finals	34	Salle Bir El Djir
	16:00	17:30	FRA - TUN	Men	Quarter-finals	35	Palais Sports Hammou Boutlélis
	16:00	17:30	GRE - ESP	Women	Quarter-finals	36	Salle Bir El Djir
	19:00	20:30	CRO - GRE	Men	Quarter-finals	37	Palais Sports Hammou Boutlélis
	19:00	20:30	TUR - TUN	Women	Quarter-finals	38	Salle Bir El Djir
	FRI 1 JUL 2022	9:30	11:00	EGY - TUN	Women	Semifinals 5-8	39
12:30		14:00	CRO - GRE	Women	Semifinals 5-8	40	Salle Bir El Djir
16:00		17:30	TUR - GRE	Men	Semifinals 5-8	41	Salle Bir El Djir
19:00		20:30	EGY - TUN	Men	Semifinals 5-8	42	Salle Bir El Djir
SAT 2 JUL 2022	9:30	11:00	TUN - CRO	Women	Final 7th-8th Place	43	Salle Bir El Djir
	10:00	11:30	SRB - TUR	Women	Semi-finals	47	Palais Sports Hammou Boutlélis
	12:30	14:00	EGY - GRE	Women	Final 5th-6th Place	44	Salle Bir El Djir
	13:00	14:30	ITA - ESP	Women	Semi-finals	48	Palais Sports Hammou Boutlélis



## Competition Schedule

As of SAT 2 JUL 2022 at 23:57

Date	Start Time	Estimated Finish Time	Teams	Gender	Phase	Game No.	Venue
MON 4 JUL 2022	16:00	17:30	GRE - EGY	Men	Final 7th-8th Place	45	Salle Bir El Djir
	16:30	18:00	ITA - CRO	Men	Semi-finals	49	Palais Sports Hammou Boutlélis
	19:00	20:30	TUR - TUN	Men	Final 5th-6th Place	46	Salle Bir El Djir
	19:30	21:00	ESP - FRA	Men	Semi-finals	50	Palais Sports Hammou Boutlélis
	9:30	11:00	SRB - ESP	Women	Bronze-medal Match	51	Palais Sports Hammou Boutlélis
	13:00	14:30	ITA - FRA	Men	Bronze-medal Match	52	Palais Sports Hammou Boutlélis
	16:30	18:00	TUR - ITA	Women	Gold-medal Match	53	Palais Sports Hammou Boutlélis
	20:00	21:30	CRO - ESP	Men	Gold-medal Match	54	Palais Sports Hammou Boutlélis

### LEGEND

L Loser

No. Number

W Winner



## Medallists by event

As of MON 4 JUL 2022 at 22:21

Event Name	Date	Medal	Name	CTRY Code
Women	MON 4 JUL 2022	Gold	<b>ITALY</b> BOSIO Francesca BATTISTONI Ilaria D'ODORICO Sofia SQUARCINI Federica PANETONI Sara ENWEONWU Nkemdilim Terry PERINELLI Elena MAZZARO Alessia CAGNIN Emma DIOP Bintou FROSINI Giorgia NWAKALOR Linda Nkiruka	ITA
		Silver	<b>TURKIYE</b> YILMAZ Melis AYDIN Ilkin ARICI Emine AKYALDIZ Ezgi UNAL Buse KILIC Aslihan AKYOL Aycin KAYACAN SONSIRMA Buse YUZGENC Tutku Burcu YILDIRIM Yasemin CEBECIOGLU Derya ERKEK Yaprak	TUR



## Medallists by event

As of MON 4 JUL 2022 at 22:21

Event Name	Date	Medal	Name	CTRY Code
Women	MON 4 JUL 2022	Bronze	<b>SERBIA</b> TAUBNER Tara TISMA Andrea OSMAJIC Minja GOCANIN Bojana CVETKOVIC Jovana KURTAGIC Hena MALESEVIC Ana SAVIC Vanja KOCKAREVIC Isidora TICA Branka IVANOVIC Vanja PEROVIC Rada	SRB



## Medallists by event

As of MON 4 JUL 2022 at 22:21

Event Name	Date	Medal	Name	CTRY Code
Men	MON 4 JUL 2022	Gold	<b>CROATIA</b> VISIC Petar PERIC Stipe NIKACEVIC Kruno BAKONJI Bernard SEDLACEK Marko HANZIC Tino SESTAN Filip DIRLIC Petar PERVAN Hrvoje MITRASINOVIC Tomislav MIHALJ Ivan ZELJKOVIC Ivan	CRO
		Silver	<b>SPAIN</b> RODRIGUEZ PEREZ Victor RUIZ MIRA Borja RAMON FERRAGUT Jordi LARRANAGA LEDO Unai DIEDHIOU DIATTA Jean Pascal VILLENA RODRIGUEZ Andres Jesus GIMENEZ HERNANDEZ Jose Maria IRIBARNE FERNANDEZ Francisco Javier GIMENO RUBIO Alvaro MARTIN PEREZ Cesar LOPEZ ALACIO David DE AMO FERNANDEZ Miguel Angel	ESP



## Medallists by event

As of MON 4 JUL 2022 at 22:21

Event Name	Date	Medal	Name	CTRY Code
Men	MON 4 JUL 2022	Bronze	<b>ITALY</b> FERRATO Leonardo RECINE Francesco CROSATO Federico POL Alberto FALASCHI Marco GARDINI Davide MAGALINI Giulio DI MARTINO Gabriele GIRONI Fabrizio SCHIRO Andrea CATANIA Damiano VITELLI Marco	ITA



## Medallists

As of MON 4 JUL 2022 at 22:21

Gold	Silver	Bronze
<b>CRO - Croatia</b>	<b>ESP - Spain</b>	<b>ITA - Italy</b>
1 VISIC Petar	3 RODRIGUEZ PEREZ Victor	2 FERRATO Leonardo
3 PERIC Stipe	6 RUIZ MIRA Borja	3 RECINE Francesco
4 NIKACEVIC Kruno	7 RAMON FERRAGUT Jordi	4 CROSATO Federico
6 BAKONJI Bernard	8 LARRANAGA LEDO Unai	8 POL Alberto
7 SEDLACEK Marko	12 DIEDHIOU DIATTA Jean Pascal	10 FALASCHI Marco
9 HANZIC Tino	13 VILLENA RODRIGUEZ Andres Jesus	11 GARDINI Davide
10 SESTAN Filip	15 GIMENEZ HERNANDEZ Jose Maria	14 MAGALINI Giulio
11 DIRLIC Petar	18 IRIBARNE FERNANDEZ Francisco Javier	15 DI MARTINO Gabriele
13 PERVAN Hrvoje	20 GIMENO RUBIO Alvaro	18 GIRONI Fabrizio
14 MITRASINOVIC Tomislav	21 MARTIN PEREZ Cesar	21 SCHIRO Andrea
17 MIHALJ Ivan	24 LOPEZ ALACIO David	23 CATANIA Damiano
19 ZELJKOVIC Ivan	77 DE AMO FERNANDEZ Miguel Angel	25 VITELLI Marco





## Final Standings

As of MON 4 JUL 2022 at 23:12

P4

Medal	Rank	Team
Gold	1	CRO - Croatia
Silver	2	ESP - Spain
Bronze	3	ITA - Italy
	4	FRA - France
	5	TUR - Turkiye
	6	TUN - Tunisia
	7	GRE - Greece
	8	EGY - Egypt
	9	MKD - North Macedonia
	10	ALG - Algeria
	10	SRB - Serbia



## Team Roster

As of SAT 25 JUN 2022 at 23:29

### ALG - Algeria

No.	Name	Shirt Name	Pos.	Height m / ft	Weight kg / lb	Date of Birth	Club
1	ACHOURI Ilyas		L	1.75 / 5'9"	70/154	26 FEB 1987	
2	BOUYOUCHEF Sofiane		MB	1.90 / 6'3"	80/176	7 JAN 1995	
3	KERBOUA Ahmed Amir		WS	1.88 / 6'2"	76/168	16 JUL 1992	
6	OUMESSAD Mohamed Amine		MB	1.88 / 6'2"	70/154	22 DEC 1986	
7	KERBOUA Ali		WS	1.90 / 6'3"	80/176	17 APR 1983	
8	IKKEN Boudjemaa		OS	1.90 / 6'3"	80/176	20 JAN 1996	
9	HAMIMES Abderraouf		S	1.90 / 6'3"	80/176	28 OCT 1996	
11	HOSNI Soufiane		WS	1.90 / 6'3"	80/176	28 APR 1992	
16	OULD CHERCHALI Islem		MB	1.90 / 6'3"	80/176	2 JUN 1994	
17	TIZIT Farouk		WS	1.90 / 6'3"	80/176	13 JAN 2000	
18	SOUALEM Billel		WS	1.90 / 6'3"	80/176	1 JAN 1990	
20	BOUROUBA Youssouf		OS	1.90 / 6'3"	80/176	11 JAN 1997	
		<b>Team Minimum</b>		1.75 / 5'9"	70/154		
		<b>Team Average</b>		1.88 / 5'9"	78/154		
		<b>Team Maximum</b>		1.9 / 5'9"	80/154		

#### Technical Staff:

Team Assistant Coach	ACHOURI Salim
Team Assistant Coach	ASSAM Samir
Physiotherapist	ADJIMI Karim

#### LEGEND

<b>(C)</b> Team Captain	<b>BH</b> Both Handed	<b>Han.</b> Handedness	<b>L</b> Libero
<b>LH</b> Left Handed	<b>MB</b> Middle Blocker	<b>No.</b> Shirt Number	<b>OS</b> Opposite Spiker
<b>Pos</b> Playing Position	<b>RH</b> Right Handed	<b>S</b> Setter	<b>WS</b> Wing Spiker



## Team Roster

As of SAT 25 JUN 2022 at 23:29

### CRO - Croatia

No.	Name	Shirt Name	Pos.	Height m / ft	Weight kg / lb	Date of Birth	Club
1	VISIC Petar	Višić	S	1.98 / 6' 6"	88/194	11 FEB 1998	HAOK Mladost, Zagreb (CRO)
3	PERIC Stipe	Peric	MB	2.04 / 6' 8"	90/198	7 MAY 1997	DEYA Sport, Burgas (BUL)
4	NIKACEVIC Kruno	Nikacevic	MB	2.02 / 6' 8"	93/205	11 JAN 1996	HAOK Mladost, Zagreb (CRO)
6	BAKONJI Bernard	Bakonji	S	2.00 / 6' 7"	90/198	28 NOV 1997	HAOK Mladost, Zagreb (CRO)
7	SEDLACEK Marko	Sedlacek	WS	2.02 / 6' 8"	95/209	29 JUL 1996	Galatasaray, Istanbul (TUR)
9	HANZIC Tino	Hanžić	WS	1.98 / 6' 6"	93/205	24 OCT 2000	Pool Libertas Cantu, Cantu (ITA)
10	SESTAN Filip	Šestan	WS	1.95 / 6' 5"	90/198	6 JUN 1995	Arcada Galati, Galati (ROU)
11	DIRLIC Petar	Đirlić	OS	2.06 / 6' 9"	101/223	27 MAY 1997	Top Volley Cisterna, Cisterna di Latina (I)
13	PERVAN Hrvoje	Pervan	L	1.87 / 6' 2"	77/170	8 DEC 1994	OK Ribola Kaštela, Kastela (CRO)
14	MITRASINOVIC Tomislav	Mitrašinovic	OS	2.05 / 6' 9"	94/207	14 FEB 2000	Cambrai, Cambrai (FRA)
17	MIHALJ Ivan	Mihalj	MB	2.11 / 6' 11"	101/223	23 NOV 1990	A.O.P. Kifissia, Athens (GRE)
29	ZELJKOVIC Ivan	Zeljko	WS	1.85 / 6' 1"	86/190	31 AUG 1994	HAOK Mladost, Zagreb (CRO)
				<b>Team Minimum</b>	1.85 / 6' 1"	77/170	
				<b>Team Average</b>	1.99 / 6' 1"	92/170	
				<b>Team Maximum</b>	2.11 / 6' 1"	101/170	

Uniform Colours	Shirt	Shorts
Main	Blue	Blue
2nd	White	Blue
3rd	Red	Blue

#### Technical Staff:

Team Assistant Coach	COSKOVIC Tomislav
Team Assistant Coach	QUERIN Gael
Physiotherapist	PENGA Luka

#### LEGEND

(C)	Team Captain	BH	Both Handed	Han.	Handedness	L	Libero
LH	Left Handed	MB	Middle Blocker	No.	Shirt Number	OS	Opposite Spiker
Pos	Playing Position	RH	Right Handed	S	Setter	WS	Wing Spiker



## Team Roster

As of SAT 25 JUN 2022 at 23:29

EGY - Egypt

No.	Name	Shirt Name	Pos.	Height m / ft	Weight kg / lb	Date of Birth	Club
1	ELSAYED Ahmed		S	1.84 / 6' 0"	84/185	14 JAN 1991	
6	HASSAN Mohamed		L	1.75 / 5' 9"	73/161	28 SEP 1993	
7	ALI Seifeldin		OS	1.93 / 6' 4"	90/198	14 JUL 1999	
8	EISSA Abdelrahman		WS	1.86 / 6' 1"	85/187	24 AUG 2001	
10	MASOUD Mohamed		MB	2.11 / 6' 11"	105/231	1 MAY 1994	
13	KHATER Mohamed		MB	2.02 / 6' 8"	98/216	4 JUL 1991	
14	MORGAN Yossef		S	1.84 / 6' 0"	86/190	13 APR 1999	
16	SOLIMAN Mohamed		MB	2.08 / 6' 10"	90/198	4 JAN 1995	
18	SHFIK Ahmed		WS	1.90 / 6' 3"	89/196	7 DEC 1994	
19	MOHAMED Zyad		OS	1.95 / 6' 5"	89/196	25 MAR 2003	
21	AWAD Youssef		WS	1.94 / 6' 4"	90/198	27 AUG 2000	
23	OMAR Ahmed		WS	1.96 / 6' 5"	93/205	4 MAR 1995	
		<b>Team Minimum</b>		1.75 / 5' 9"	73/161		
		<b>Team Average</b>		1.93 / 5' 9"	89/161		
		<b>Team Maximum</b>		2.11 / 5' 9"	105/161		

### Technical Staff:

Coach	SALEM Sayed
Team Assistant Coach	ASHOUR Ahmed
Physiotherapist	ZALAM Sameh

### LEGEND

<b>(C)</b> Team Captain	<b>BH</b> Both Handed	<b>Han.</b> Handedness	<b>L</b> Libero
<b>LH</b> Left Handed	<b>MB</b> Middle Blocker	<b>No.</b> Shirt Number	<b>OS</b> Opposite Spiker
<b>Pos</b> Playing Position	<b>RH</b> Right Handed	<b>S</b> Setter	<b>WS</b> Wing Spiker



## Team Roster

As of SAT 25 JUN 2022 at 23:29

### ESP - Spain

No.	Name	Shirt Name	Pos.	Height m / ft	Weight kg / lb	Date of Birth	Club
1	IRIBARNE FERNANDEZ Francisco Javier	IRIBARNE	WS	1.98 / 6' 6"	95/209	13 JUL 1998	RIO DUERO SORIA, SORIA (ESP)
3	RODRIGUEZ PEREZ Victor	RODRIGUEZ	WS	1.99 / 6' 6"	87/192	21 SEP 1998	GRAND NANCY, NANCY (FRA)
6	RUIZ MIRA Borja	B.RUIZ	MB	2.00 / 6' 7"	107/236	26 JUL 1992	GUAGUAS, LAS PALMAS GC (ESP)
7	RAMON FERRAGUT Jordi	RAMON	WS	1.91 / 6' 3"	89/196	9 JUL 1999	TSV HERRSCHING, HERRSCHING (G)
8	LARRANAGA LEDO Unai	LARRAÑAGA	L	1.80 / 5' 11"	72/159	9 MAY 2000	TEXTIL SANTANDERINA, CABEZON D
12	DIEDHIU DIATTA Jean Pascal	DIEDHIU	MB	2.10 / 6' 11"	90/198	8 OCT 1993	CV MELILLA, MELILLA (ESP)
15	GIMENEZ HERNANDEZ Jose Maria		WS	1.88 / 6' 2"	80/176	1 APR 1995	
16	VILLENA RODRIGUEZ Andres Jesus	VILLENA	OS	1.96 / 6' 5"	94/207	27 FEB 1993	CV TERUEL, TERUEL (ESP)
20	GIMENO RUBIO Alvaro	GIMENO	OS	2.07 / 6' 9"	93/205	27 SEP 1999	RIO DUERO SORIA, SORIA (ESP)
21	MARTIN PEREZ Cesar	MARTIN	S	1.87 / 6' 2"	82/181	18 DEC 1995	GUAGUAS, LAS PALMAS DE G. C. (ES)
24	LOPEZ ALACIO David		MB	1.96 / 6' 5"	88/194	14 SEP 2000	
77	DE AMO FERNANDEZ Miguel Angel	DE AMO	OS	1.88 / 6' 2"	81/179	16 SEP 1985	CESKE BUDEJOVICE, BUDEJOVICE (
				<b>Team Minimum</b>	1.80 / 5' 11"	72/159	
				<b>Team Average</b>	1.95 / 5' 11"	88/159	
				<b>Team Maximum</b>	2.1 / 5' 11"	107/159	

Uniform Colours	Shirt	Shorts
Main	Red	Blue
2nd	Yellow	Red

#### Technical Staff:

Team Assistant Coach	MOLTO CARBONELL Jose Luis
Physiotherapist	SORIANO CORTES Jorge

#### LEGEND

(C)	Team Captain	BH	Both Handed	Han.	Handedness	L	Libero
LH	Left Handed	MB	Middle Blocker	No.	Shirt Number	OS	Opposite Spiker
Pos	Playing Position	RH	Right Handed	S	Setter	WS	Wing Spiker



## Team Roster

As of SAT 25 JUN 2022 at 23:29

### FRA - France

No.	Name	Shirt Name	Pos.	Height m / ft	Weight kg / lb	Date of Birth	Club
1	MOTTA PAES Kellian	MOTTA PAES	S	1.92 / 6 ' 4 "	84/185	24 MAR 2002	PARIS VOLLEY, PARIS (FRA)
2	RAMON Luca	RAMON	L			10 AUG 2000	STADE POITEVIN, POITIERS (FRA)
3	NEVOT Thomas	NEVOT	S			30 APR 1995	PLESSIS-ROBINSON VOLLEY-BALL,
6	LAWANI Ibrahim	LAWANI	OS	1.98 / 6 ' 6 "	88/194	15 SEP 2001	PARIS VOLLEY, PARIS (FRA)
7	PANOU Joachim	PANOU	WS	1.97 / 6 ' 6 "	97/214	27 AUG 1997	T.O.A.C. - T.U.C. VOLLEY-BALL, TOUL
8	REBEYROL Francois	REBEYROL	WS			2 JUL 1999	PLESSIS-ROBINSON VOLLEY-BALL,
9	BASIC Lukas (C)	BASIC	WS	1.98 / 6 ' 6 "		29 JAN 1995	MONTPELLIER CASTELNAU VOLLEY
10	FAURE Theo	FAURE	OS			12 OCT 1999	MONTPELLIER CASTELNAU VOLLEY
11	POTHRON Antoine	POTHRON	WS	1.98 / 6 ' 6 "	87/192	5 MAR 2002	T.O.A.C. - T.U.C. VOLLEY-BALL, TOUL
12	KABA Kevin	KABA	MB			8 JUN 1994	T.O.A.C. - T.U.C. VOLLEY-BALL, TOUL
13	GUEYE Mousse	GUEYE	MB	1.98 / 6 ' 6 "	84/185	11 NOV 1996	CHAUMONT VB, CHAUMONT (FRA)
15	ROEHRIG Simon	ROEHRIG	MB	1.99 / 6 ' 6 "	95/209	19 NOV 2000	TOURCOING VB L.M, TOURCOING (F)
<b>Team Minimum</b>							
<b>Team Average</b>				1.97 / 0	89/0		
<b>Team Maximum</b>				1.99 / 0	97/0		

Uniform Colours	Shirt	Shorts
Main	Blue	Blue
2nd	White	White
3rd	Red	Red

#### Technical Staff:

Coach	GUIBOREL Julien
Coach	SAPINART Stephane
Coach	ROUXEL Lionel Bertrand Jean
Team Assistant Coach	AUDABRAM Olivier
Team Assistant Coach	ROYER Thomas
Physiotherapist	ORFANOTTI - RAULET Romain

#### LEGEND

(C)	Team Captain	BH	Both Handed	Han.	Handedness	L	Libero
LH	Left Handed	MB	Middle Blocker	No.	Shirt Number	OS	Opposite Spiker
Pos	Playing Position	RH	Right Handed	S	Setter	WS	Wing Spiker



## Team Roster

As of SAT 25 JUN 2022 at 23:29

### GRE - Greece

No.	Name	Shirt Name	Pos.	Height m / ft	Weight kg / lb	Date of Birth	Club
1	CHANDRINOS Aristeidis	CHANDRINOS A.	L	1.85 / 6 ' 1 "	74/163	20 NOV 2002	AONS MILON, Athens (GRE)
5	CHANDRINOS Spyridon	CHANDRINOS S.	WS	2.00 / 6 ' 7 "	89/196	24 FEB 2001	AONS MILON, Athens (GRE)
6	KOMITOU DIS Dimitrios	KOMITOU DIS	S	1.93 / 6 ' 4 "	91/201	4 OCT 1995	PIGASOS POLICHNIS, Thessaloniki (G)
7	PETREAS Georgios (C)	PETREAS	MB	2.01 / 6 ' 7 "	93/205	19 NOV 1986	PAOK, Thesaloniki (GRE)
8	TZIOUMAKAS Georgios		OS	2.05 / 6 ' 9 "	105/231	23 JAN 1995	
11	KASAMPALIS Stavros	KASAMPALIS	S	1.88 / 6 ' 2 "	88/194	1 JUN 1995	AOP KIFISIAS, Athens (GRE)
12	VOULKIDIS Theodoros	VOULKIDIS	MB	2.00 / 6 ' 7 "	93/205	30 MAR 1996	STADE POITEVIN, Poitiers (FRA)
13	ANDREOPOULOS Charalampos	ANDREOPOULOS	WS	1.93 / 6 ' 4 "	85/187	23 JAN 2001	PANATHINAIKOS, ATHENS (GRE)
15	RAPTIS Alexandros	RAPTIS	WS	2.00 / 6 ' 7 "	95/209	16 FEB 2000	PANATHINAIKOS, Athens (GRE)
19	MOUCHLIAS Dimitrios	MOUCHLIAS	OS	2.00 / 6 ' 7 "	78/172	17 MAY 2001	UNIVERSITY OF HAWAII, Hawaii (USA)
22	LINARDOS Dimosthenis		MB	2.03 / 6 ' 8 "	94/207	14 FEB 1997	
23	CHAKAS Spyridon	CHAKAS	WS	1.95 / 6 ' 5 "	82/181	23 SEP 2002	UNIVERSITY OF HAWAII, Hawaii (USA)
		<b>Team Minimum</b>		1.85 / 6 ' 1 "	74/163		
		<b>Team Average</b>		1.97 / 6 ' 1 "	89/163		
		<b>Team Maximum</b>		2.05 / 6 ' 1 "	105/163		

Uniform Colours	Shirt	Shorts
Main	Blue	Blue
2nd	White	White

#### Technical Staff:

Team Assistant Coach	CHRISTOFIDELIS Konstantinos
Team Assistant Coach	PAPI Samuele
Physiotherapist	SEIMEKIS Dimitrios

#### LEGEND

(C)	Team Captain	BH	Both Handed	Han.	Handedness	L	Libero
LH	Left Handed	MB	Middle Blocker	No.	Shirt Number	OS	Opposite Spiker
Pos	Playing Position	RH	Right Handed	S	Setter	WS	Wing Spiker



## Team Roster

As of SAT 25 JUN 2022 at 23:29

### ITA - Italy

No.	Name	Shirt Name	Pos.	Height m / ft	Weight kg / lb	Date of Birth	Club
2	FERRATO Leonardo		S			25 DEC 2001	
3	RECINE Francesco	RECINE	WS			7 FEB 1999	GAS SALES BLUENERGY PIACENZA,
4	CROSATO Federico	CROSATO	MB			22 MAY 2002	KIOENE PADOVA, PADOVA (ITA)
8	POL Alberto		WS			4 MAR 2001	
10	FALASCHI Marco	FALASCHI	S			18 SEP 1987	PRISMA TARANTO, TARANTO (ITA)
11	GARDINI Davide	GARDINI	WS			11 FEB 1999	BRIGHAMYOUNG UNIVERSITY, PRO
14	MAGALINI Giulio	MAGALINI	WS			14 AUG 2001	VERONA VOLLEY, VERONA (ITA)
15	DI MARTINO Gabriele	DI MARTINO	MB			20 JUL 1997	PRISMA TARANTO, TARANTO (ITA)
18	GIRONI Fabrizio	GIRONI	WS			18 MAR 2000	PRISMA TARANTO, TARANTO (ITA)
21	SCHIRO Andrea		OS			10 SEP 2001	
23	CATANIA Damiano	CATANIA	L			28 MAR 2001	GAS SALES BLUENERGY PIACENZA,
25	VITELLI Marco	VITELLI	MB			4 APR 1996	KIOENE PADOVA, PADOVA (ITA)

Team Minimum

Team Average

Team Maximum

Uniform Colours	Shirt	Shorts
Main	Blue	Blue
2nd	White	White

#### Technical Staff:

Team Assistant Coach	ANDREONI Francesco
Team Assistant Coach	DI PINTO Adriano
Team Doctor	PENZA Marco
Physiotherapist	ROSSIN Fabio

#### LEGEND

(C)	Team Captain	BH	Both Handed	Han.	Handedness	L	Libero
LH	Left Handed	MB	Middle Blocker	No.	Shirt Number	OS	Opposite Spiker
Pos	Playing Position	RH	Right Handed	S	Setter	WS	Wing Spiker





## Team Roster

As of SAT 25 JUN 2022 at 23:29

MKD - North Macedonia

No.	Name	Shirt Name	Pos.	Height m / ft	Weight kg / lb	Date of Birth	Club
2	GJORGIEV Gjorgi		S	1.97 / 6' 6"	88/194	22 MAY 1992	
3	ALEKSOV Stefan		OS	1.95 / 6' 5"	80/176	5 AUG 1996	
4	GJORGIEV Nikola (C)		OS	1.95 / 6' 5"	93/205	23 JUL 1988	
5	MILEV Vlado		WS	1.95 / 6' 5"	90/198	9 MAY 1987	
6	RICHLIEV Kostadin		L	1.85 / 6' 1"	71/157	21 MAR 2000	
7	NAKOV Slave		MB	1.94 / 6' 4"	85/187	25 AUG 1994	
11	DESPOTOVSKI Filip		S	1.95 / 6' 5"	90/198	2 JUL 1986	
15	MADJUNKOV Filip		MB	1.99 / 6' 6"	95/209	18 MAR 1996	
16	ILIEV Stojan		WS	1.89 / 6' 2"	85/187	3 MAR 1999	
17	KOSTIKJ Luka		WS	1.94 / 6' 4"	75/165	12 OCT 2001	
18	MIHAILOV Vase		WS	1.98 / 6' 6"	100/220	15 SEP 1986	
20	SAVOVSKI Filip		MB	2.06 / 6' 9"	91/201	4 AUG 2002	
		<b>Team Minimum</b>		1.85 / 6' 1"	71/157		
		<b>Team Average</b>		1.95 / 6' 1"	87/157		
		<b>Team Maximum</b>		2.06 / 6' 1"	100/157		

Uniform Colours	Shirt	Shorts
Main	White	

### Technical Staff:

Team Assistant Coach	NAHOD Djordje
Team Assistant Coach	CRVENKOVSKI Aleksandar
Trainer	PANKOVIC Goran

### LEGEND

(C)	Team Captain	BH	Both Handed	Han.	Handedness	L	Libero
LH	Left Handed	MB	Middle Blocker	No.	Shirt Number	OS	Opposite Spiker
Pos	Playing Position	RH	Right Handed	S	Setter	WS	Wing Spiker



## Team Roster

As of SAT 25 JUN 2022 at 23:29

### SRB - Serbia

No.	Name	Shirt Name	Pos.	Height m / ft	Weight kg / lb	Date of Birth	Club
1	NIKOLIC Uros	NIKOLIC U.	MB	1.92 / 6' 4"	83/183	27 JUL 1998	Verona, Verona (ITA)
7	POLOMAC Andrej	POLOMAC	S	1.96 / 6' 5"	90/198	24 AUG 2004	Takovo, Gornji Milanovac (SRB)
10	NIKOLIC Dusan	NIKOLIC.D	WS	1.93 / 6' 4"	80/176	2 AUG 2001	Crvena Zvezda, Beograd (SRB)
11	BATAK Aleksa	BATAK	S	1.93 / 6' 4"	78/172	18 JAN 2000	As Cannes, Cannes (FRA)
16	STEFANOVIC Aleksandar		MB	1.84 / 6' 0"	77/170	22 NOV 1998	
19	NEGIC Stefan	NEGIC	L	1.93 / 6' 4"	83/183	17 JAN 2000	Vojvodina NS Seme, Novi Sad (SRB)
23	VUCICEVIC Bozidar		OS	1.79 / 5' 10"	72/159	9 DEC 1998	
24	SKAKIC Stefan	SKAKIC	WS	1.86 / 6' 1"	80/176	19 OCT 1999	Crvena Zvezda, Beograd (SRB)
25	TADIC Luka	TADIC	WS	1.91 / 6' 3"	82/181	10 OCT 2000	Crvena Zvezda, Beograd (SRB)
28	MARINOVIC Lazar (C)	MARINOVIC	WS	1.75 / 5' 9"	68/150	7 JUN 1998	Partizan, Beograd (SRB)
34	BAJANDIC Lazar	BAJANDIC	WS	1.88 / 6' 2"	80/176	2 APR 1999	Vojvodina NS Seme, Novi Sad (SRB)
35	RUDIC Andrej	RUDIC	MB	1.87 / 6' 2"	80/176	17 FEB 1999	Vojvodina NS Seme, Novi Sad (SRB)
		<b>Team Minimum</b>		1.75 / 5' 10"	68/150		
		<b>Team Average</b>		1.88 / 5' 10"	79/150		
		<b>Team Maximum</b>		1.96 / 5' 10"	90/150		

Uniform Colours	Shirt	Shorts
Main	Blue	Blue
2nd	White	White
3rd	Red	Red

#### Technical Staff:

Team Assistant Coach	VLAJIC Filip
Team Assistant Coach	KOVACEVIC Nenad
Physiotherapist	POPOVIC Ivan

#### LEGEND

(C)	Team Captain	BH	Both Handed	Han.	Handedness	L	Libero
LH	Left Handed	MB	Middle Blocker	No.	Shirt Number	OS	Opposite Spiker
Pos	Playing Position	RH	Right Handed	S	Setter	WS	Wing Spiker



## Team Roster

As of SAT 25 JUN 2022 at 23:29

### TUN - Tunisia

No.	Name	Shirt Name	Pos.	Height m / ft	Weight kg / lb	Date of Birth	Club
2	KADHI Ahmed		MB	2.02 / 6' 8"	88/194	19 APR 1989	
3	BEN SLIMENE Khaled (C)		S	1.98 / 6' 6"	78/172	14 DEC 1994	
6	BEN OTHMEN MILADI Mohamed Ali		WS	1.88 / 6' 2"	73/161	12 MAY 1991	
7	KARAMOSLI Elyes		WS	1.99 / 6' 6"	99/218	22 AUG 1989	
8	ABDELHEDI Yassine		WS	1.79 / 5' 10"	78/172	28 OCT 1999	
9	AGREBI Omar		MB	2.03 / 6' 8"	84/185	26 AUG 1992	
10	NAGGA Hamza		OS	1.93 / 6' 4"	81/179	29 MAY 1990	
12	BENNOUR Rami		S	1.85 / 6' 1"	79/174	23 DEC 1991	
13	MBARKI Selim	MBARKI	MB	2.00 / 6' 7"	85/187	6 MAR 1996	
18	BONGUI Ali		OS	2.02 / 6' 8"	75/165	14 AUG 1996	
19	BOUGUERRA Aymen		WS	1.98 / 6' 6"	80/176	1 NOV 2001	
20	HMISSI Saddam		L	1.86 / 6' 1"	75/165	16 FEB 1991	
		<b>Team Minimum</b>		1.79 / 5' 10"	73/161		
		<b>Team Average</b>		1.94 / 5' 10"	81/161		
		<b>Team Maximum</b>		2.03 / 5' 10"	99/161		

#### Technical Staff:

Coach	LADJIMI Khaled
Coach	BRIK Mariem
Team Doctor	GRINDI Karim
Team Doctor	KEFI Mourad
Physiotherapist	TLILI Youssef
Physiotherapist	RAQUINE Nour

#### LEGEND

<b>(C)</b> Team Captain	<b>BH</b> Both Handed	<b>Han.</b> Handedness	<b>L</b> Libero
<b>LH</b> Left Handed	<b>MB</b> Middle Blocker	<b>No.</b> Shirt Number	<b>OS</b> Opposite Spiker
<b>Pos</b> Playing Position	<b>RH</b> Right Handed	<b>S</b> Setter	<b>WS</b> Wing Spiker



## Team Roster

As of SAT 25 JUN 2022 at 23:29

### TUR - Turkey

No.	Name	Shirt Name	Pos.	Height m / ft	Weight kg / lb	Date of Birth	Club
1	EKSI Aslan		S			14 MAY 1989	
3	DOGRULUK Oguzhan		WS			1 JAN 1998	
5	YATGIN Ogulcan		S			28 APR 1997	
8	GOKGOZ Gokhan		WS			6 JAN 1993	
9	HACIOGLU Mehmet		WS			29 MAR 1995	
10	OGBAI Cansin Enaboifo		OS			7 SEP 1995	
12	UNVER Izzet (C)		WS			1 JAN 1992	
13	TOSUN Burakhan		MB			17 JAN 1998	
15	TOY Metin		OS			3 MAY 1994	
17	ULU Dogukan		MB			30 OCT 1995	
19	BAYRAKTAR Berkay		L			1 JAN 1998	
20	CENGIZ Mustafa		MB			29 MAY 1998	
		<b>Team Minimum</b>					
		<b>Team Average</b>					
		<b>Team Maximum</b>					

#### Technical Staff:

Team Assistant Coach ERYILMAZ Kerem  
Trainer APAYDIN Murat

#### LEGEND

(C)	Team Captain	BH	Both Handed	Han.	Handedness	L	Libero
LH	Left Handed	MB	Middle Blocker	No.	Shirt Number	OS	Opposite Spiker
Pos	Playing Position	RH	Right Handed	S	Setter	WS	Wing Spiker



## Results Table - Preliminary Round

P4

As of TUE 28 JUN 2022 at 23:32

Group A				Points per Set					Total Points	Match Duration	Spectators
Match	Date	Teams	Sets	1	2	3	4	5			
1	SUN 26 JUN 2022	EGY vs ITA	0 - 3	14 - 25	20 - 25	20 - 25			54 - 75	1h16	
11	MON 27 JUN 2022	MKD vs EGY	0 - 3	23 - 25	23 - 25	20 - 25			66 - 75	1h23	400
21	TUE 28 JUN 2022	ITA vs MKD	3 - 0	25 - 19	25 - 16	25 - 23			75 - 58	1h16	400

Group B				Points per Set					Total Points	Match Duration	Spectators
Match	Date	Teams	Sets	1	2	3	4	5			
7	SUN 26 JUN 2022	TUR vs ALG	3 - 0	25 - 22	25 - 23	25 - 23			75 - 68	1h35	1000
9	SUN 26 JUN 2022	FRA vs GRE	3 - 2	30 - 28	22 - 25	20 - 25	25 - 19	18 - 16	115 - 113	2h37	1000
17	MON 27 JUN 2022	ALG vs FRA	0 - 3	18 - 25	18 - 25	16 - 25			52 - 75	1h14	3800
19	MON 27 JUN 2022	GRE vs TUR	3 - 2	25 - 23	22 - 25	25 - 8	23 - 25	15 - 13	110 - 94	2h19	400
27	TUE 28 JUN 2022	GRE vs ALG	0 - 3	24 - 26	20 - 25	19 - 25			63 - 76	1h39	4500
29	TUE 28 JUN 2022	TUR vs FRA	0 - 3	21 - 25	22 - 25	18 - 25			61 - 75	1h27	1000

Group C				Points per Set					Total Points	Match Duration	Spectators
Match	Date	Teams	Sets	1	2	3	4	5			
3	SUN 26 JUN 2022	TUN vs SRB	3 - 0	25 - 22	25 - 15	25 - 20			75 - 57	1h27	
5	SUN 26 JUN 2022	CRO vs ESP	3 - 1	27 - 25	25 - 23	22 - 25	28 - 26		102 - 99	2h11	1000
13	MON 27 JUN 2022	SRB vs CRO	0 - 3	20 - 25	19 - 25	28 - 30			67 - 80	1h30	400
15	MON 27 JUN 2022	ESP vs TUN	3 - 0	25 - 17	25 - 17	25 - 22			75 - 56	1h21	1000
23	TUE 28 JUN 2022	ESP vs SRB	3 - 2	22 - 25	25 - 19	23 - 25	25 - 23	19 - 17	114 - 109	2h36	500
25	TUE 28 JUN 2022	TUN vs CRO	3 - 2	22 - 25	25 - 21	20 - 25	25 - 19	23 - 21	115 - 111	2h35	2800

Statistics of	Average match duration	Average spectators	Total spectators
Preliminary	1h46	1213	18200

Group A																	
Rank	Team	Matches			Ranking Points	Results Details						Sets			Points		
		Played	Won	Lost		3-0	3-1	3-2	2-3	1-3	0-3	Won	Lost	Ratio	Won	Lost	Ratio
1	ITA	2	2	0	6	2						6	0	MAX	150	112	1.339
2	EGY	2	1	1	3	1					1	3	3	1.000	129	141	0.915
3	MKD	2	0	2	0						2	0	6	0.000	124	150	0.827

Group B																	
Rank	Team	Matches			Ranking Points	Results Details						Sets			Points		
		Played	Won	Lost		3-0	3-1	3-2	2-3	1-3	0-3	Won	Lost	Ratio	Won	Lost	Ratio
1	FRA	3	3	0	8	2		1				9	2	4.500	265	226	1.173
2	TUR	3	1	2	4	1			1		1	5	6	0.833	230	253	0.909
3	GRE	3	1	2	3			1	1		1	5	8	0.625	286	285	1.004
4	ALG	3	1	2	3	1					2	3	6	0.500	196	213	0.920

Group C																	
Rank	Team	Matches			Ranking Points	Results Details						Sets			Points		
		Played	Won	Lost		3-0	3-1	3-2	2-3	1-3	0-3	Won	Lost	Ratio	Won	Lost	Ratio
1	CRO	3	2	1	7	1	1		1			8	4	2.000	293	281	1.043
2	ESP	3	2	1	5	1		1		1		7	5	1.400	288	267	1.079
3	TUN	3	2	1	5	1		1			1	6	5	1.200	246	243	1.012
4	SRB	3	0	3	1				1		2	2	9	0.222	233	269	0.866

LEGEND

MAX Ratio with no points or sets lost      Ratio Ratio of points or sets won/lost



SUN 26 JUN 2022

Start Time 9:02 - End Time 10:18

Match Duration 1h16

**Results**
**P2**
**EGY vs ITA**  
**0 3**

Team	Sets	1	2	3	Total
EGY	0	14	20	20	54
ITA	3	25	25	25	75
	<b>Playing Time</b>	22min	26min	24min	1h12

First Referee: Sébastien JACOB (FRA)

Second Referee: Tomislav POPOVIC (SRB)

EGY - Egypt								
No.	Name	Pos.	1	2	3	4	5	Pts
1	ELSAIED Ahmed	S	7	2	1			
6	HASSAN Mohamed	L	L	L	L			
7	ALI Seifeldin	OS	3					1
8	EISSA Abdelrahman	WS		23	5			1
10	MASOUD Mohamed (C)	MB	2	4	6			3
13	KHATER Mohamed	MB	5	1				8
14	MORGAN Youssef	S	6					
16	SOLIMAN Mohamed	MB			3			2
18	SHFIK Ahmed	WS	4	6	4			11
19	MOHAMED Zyad	OS	14	5				2
21	AWAD Youssef	WS						
23	OMAR Ahmed	WS	1	3	2			6

ITA - Italy								
No.	Name	Pos.	1	2	3	4	5	Pts
2	FERRATO Leonardo	S						
3	RECINE Francesco	WS	4	4	4			20
4	CROSATO Federico	MB						
8	POL Alberto	WS						
10	FALASCHI Marco (C)	S	3	3	3			3
11	GARDINI Davide	WS						
14	MAGALINI Giulio	WS	1	1	1			10
15	DI MARTINO Gabriele	MB	5	5	5			9
18	GIRONI Fabrizio	WS	6	6	6			10
21	SCHIRO Andrea	OS						
23	CATANIA Damiano	L	L	L	L			
25	VITELLI Marco	MB	2	2	2			7

**Coach** ELHOSSARY Hassan  
**Assistant Coach** ASHOUR Ahmed

**Coach** FANIZZA Vincenzo  
**Assistant Coach** ANDREONI Francesco / DI PINTO Adriano

**TEAM AND PLAYER PERFORMANCES**

Won	Total Atts	No.	Name	Scoring Skills	Won	Total Atts	No.	Name
28	73	Total	Team	Spike	50	80	Total	Team
10	32	18	SHFIK Ahmed		16	21	3	RECINE Francesco
8	8	13	KHATER Mohamed		10	22	18	GIRONI Fabrizio
4	5	23	OMAR Ahmed		10	18	14	MAGALINI Giulio
3	17	Total	Team	Block	6	17	Total	Team
1	2	8	EISSA Abdelrahman		3	8	15	DI MARTINO Gabriele
1	2	23	OMAR Ahmed		2	2	3	RECINE Francesco
1	4	10	MASOUD Mohamed		1	2	10	FALASCHI Marco
3	56	Total	Team	Serve	3	73	Total	Team
1	9	23	OMAR Ahmed		2	9	3	RECINE Francesco
1	10	18	SHFIK Ahmed		1	20	25	VITELLI Marco
1	5	16	SOLIMAN Mohamed					
35		Total	Team	Opp. Error	38		Total	Team
69	146	Total	Team	Total	97	170	Total	Team
11	43	18	SHFIK Ahmed	Best Scorer	20	32	3	RECINE Francesco

**LEGEND**

(C)	Team Captain	n	Starting line-up where n= starting pos	L	Substitute Libero	nn	Substitute where nn = shirt number
Atts	Attempts	L	Libero	MB	Middle Blocker	No.	Shirt Number
Opp.	Opponent	OS	Opposite Spiker	Pos	Playing Position	Pts	Points scored
S	Setter	WS	Wing Spiker				
-	-						



MON 27 JUN 2022

Start Time 8:59 - End Time 10:23

Match Duration 1h23

Spectators 400

**Results**
**P2**
**MKD vs EGY**  
**0 3**

Team	Sets	1	2	3	Total
MKD	0	23	23	20	66
EGY	3	25	25	25	75
	<b>Playing Time</b>	28min	24min	24min	1h17

First Referee: Ioannis IOANNIDIS (GRE)

Second Referee: Sébastien JACOB (FRA)

MKD - North Macedonia								
No.	Name	Pos.	1	2	3	4	5	Pts
2	GJORGIEV Gjorgi	S	5	6				1
3	ALEKSOV Stefan	OS						
4	GJORGIEV Nikola (C)	OS	2	3	3			22
5	MILEV Vlado	WS	3	1	1			8
6	RICHLIEV Kostadin	L	L	L	L			
7	NAKOV Slave	MB						
11	DESPOTOVSKI Filip	S		2	6			2
15	MADJUNKOV Filip	MB	4	5	5			
16	ILIEV Stojan	WS	6	4				5
17	KOSTIKJ Luka	WS		16	4			2
18	MIHAILOV Vase	WS						
20	SAVOVSKI Filip	MB	1	2	2			4

EGY - Egypt								
No.	Name	Pos.	1	2	3	4	5	Pts
1	ELSAYED Ahmed	S	6	1	1			1
6	HASSAN Mohamed	L	L	L	L			
7	ALI Seifeldin	OS	1		1			1
8	EISSA Abdelrahman	WS	1	2	2			14
10	MASOUD Mohamed (C)	MB	2	3	3			10
13	KHATER Mohamed	MB	5	6	6			7
14	MORGAN Yossef	S	18		18			
16	SOLIMAN Mohamed	MB		1				1
18	SHFIK Ahmed	WS	3	4	4			9
19	MOHAMED Zyad	OS						
21	AWAD Youssef	WS						
23	OMAR Ahmed	WS	4	5	5			16

**Coach** PAVLICEVIC Ratko  
**Assistant Coach** NAHOD Djordje / CRVENKOVSKI

**Coach** ELHOSSARY Hassan  
**Assistant Coach** ASHOUR Ahmed

**TEAM AND PLAYER PERFORMANCES**

Won	Total Atts	No.	Name	Scoring Skills	Won	Total Atts	No.	Name
38	81	Total	Team	Spike	41	70	Total	Team
22	40	4	GJORGIEV Nikola		13	20	23	OMAR Ahmed
7	13	5	MILEV Vlado		9	14	8	EISSA Abdelrahman
4	12	16	ILIEV Stojan		6	8	10	MASOUD Mohamed
6	25	Total	Team	Block	11	46	Total	Team
2	3	20	SAVOVSKI Filip		4	10	18	SHFIK Ahmed
1	7	11	DESPOTOVSKI Filip		3	12	10	MASOUD Mohamed
1	2	5	MILEV Vlado		2	9	23	OMAR Ahmed
0	67	Total	Team	Serve	7	74	Total	Team
					3	20	8	EISSA Abdelrahman
					2	10	13	KHATER Mohamed
					1	12	10	MASOUD Mohamed
51		Total	Team	Opp. Error	46		Total	Team
95	173	Total	Team	Total	105	190	Total	Team
22	54	4	GJORGIEV Nikola	Best Scorer	16	42	23	OMAR Ahmed

**LEGEND**

(C)	Team Captain	n	Starting line-up where n= starting pos	L	Substitute Libero	nn	Substitute where nn = shirt number
Atts	Attempts	L	Libero	MB	Middle Blocker	No.	Shirt Number
Opp.	Opponent	OS	Opposite Spiker	Pos	Playing Position	Pts	Points scored
S	Setter	WS	Wing Spiker				
-	-						



TUE 28 JUN 2022

Start Time 9:00 - End Time 10:16

Match Duration 1h16

Spectators 400

**Results**
**P2**
**ITA vs MKD**
**3 0**

Team	Sets	1	2	3	Total
ITA	3	25	25	25	75
MKD	0	19	16	23	58
	<b>Playing Time</b>	24min	23min	23min	1h10

First Referee: Tomislav POPOVIC (SRB)

Second Referee: Sébastien JACOB (FRA)

ITA - Italy								
No.	Name	Pos.	1	2	3	4	5	Pts
2	FERRATO Leonardo	S						
3	RECINE Francesco	WS	3	2	1			15
4	CROSATO Federico	MB			15			1
8	POL Alberto	WS		3	11			
10	FALASCHI Marco (C)	S	2	1	6			1
11	GARDINI Davide	WS			4			6
14	MAGALINI Giulio	WS	6	5				9
15	DI MARTINO Gabriele	MB	4	3	2			3
18	GIRONI Fabrizio	WS	5	4				7
21	SCHIRO Andrea	OS		18	3			2
23	CATANIA Damiano	L	L	L	L			
25	VITELLI Marco	MB	1	6	5			9

**Coach** FANIZZA Vincenzo  
**Assistant Coach** DI PINTO Adriano

MKD - North Macedonia								
No.	Name	Pos.	1	2	3	4	5	Pts
2	GJORGIEV Gjorgji	S	6	6	6			3
3	ALEKSOV Stefan	OS						1
4	GJORGIEV Nikola (C)	OS	3	3	3			13
5	MILEV Vlado	WS	1	1	1			7
6	RICHLIEV Kostadin	L	L	L	L			
7	NAKOV Slave	MB						
11	DESPOTOVSKI Filip	S						
15	MADJUNKOV Filip	MB	2	2	2			5
16	ILIEV Stojan	WS		17	4			3
17	KOSTIKJ Luka	WS	4	4				4
18	MIHALOV Vase	WS						
20	SAVOVSKI Filip	MB	5	5	5			6

**Coach** PAVLICEVIC Ratko  
**Assistant Coach**
**TEAM AND PLAYER PERFORMANCES**

Won	Total Atts	No. Name	Scoring Skills	Won	Total Atts	No. Name
42	79	<b>Total Team</b>	<b>Spike</b>	35	85	<b>Total Team</b>
13	22	3 RECINE Francesco		11	32	4 GJORGIEV Nikola
8	12	14 MAGALINI Giulio		6	20	5 MILEV Vlado
6	8	25 VITELLI Marco		4	6	20 SAVOVSKI Filip
3	39	<b>Total Team</b>	<b>Block</b>	4	29	<b>Total Team</b>
1	10	15 DI MARTINO Gabriele		1	8	20 SAVOVSKI Filip
1	2	21 SCHIRO Andrea		1	4	5 MILEV Vlado
1	6	10 FALASCHI Marco		1	9	15 MADJUNKOV Filip
8	73	<b>Total Team</b>	<b>Serve</b>	3	60	<b>Total Team</b>
3	14	25 VITELLI Marco		2	12	4 GJORGIEV Nikola
2	14	3 RECINE Francesco		1	9	20 SAVOVSKI Filip
1	9	18 GIRONI Fabrizio				
59		<b>Total Team</b>	<b>Opp. Error</b>	42		<b>Total Team</b>
112	191	<b>Total Team</b>	<b>Total</b>	84	174	<b>Total Team</b>

15	37	3 RECINE Francesco	<b>Best Scorer</b>	13	47	4 GJORGIEV Nikola
----	----	--------------------	--------------------	----	----	-------------------

**LEGEND**

(C) Team Captain

Atts Attempts

Opp. Opponent

S Setter

n Starting line-up where n= starting pos

L Libero

OS Opposite Spiker

WS Wing Spiker

L Substitute Libero

MB Middle Blocker

Pos Playing Position

nn Substitute where nn = shirt number

No. Shirt Number

Pts Points scored





SUN 26 JUN 2022

Start Time 18:00 - End Time 19:35

Match Duration 1h35

Spectators 2500

## Results

P2

TUR vs ALG  
3 0

Team	Sets	1	2	3	Total
TUR	3	25	25	25	75
ALG	0	22	23	23	68
	Playing Time	28min	30min	30min	1h28

First Referee: Edgar SEROLE (BOT)

Second Referee: Ioannis IOANNIDIS (GRE)

## TUR - Turkey

No.	Name	Pos.	1	2	3	4	5	Pts
1	EKSI Aslan	S	6	6	6			1
3	DOGRULUK Oguzhan	WS						
5	YATGIN Ogulcan	S	1	1	1			
8	GOKGOZ Gokhan	WS	4	4	4			12
9	HACIOGLU Mehmet	WS	17	17				
10	ENABOIFO Cansin Ogbai	OS						
12	UNVER Izzet (C)	WS	1	1	1			8
13	TOSUN Burakhan	MB	2	2	2			6
15	TOY Metin	OS	3	3	3			24
17	ULU Dogukan	MB	5	5	5			10
19	BAYRAKTAR Berkay	L	L	L	L			
20	CENGIZ Mustafa	MB						

Coach OZKAN Hakan  
Assistant Coach ERYILMAZ Kerem

## ALG - Algeria

No.	Name	Pos.	1	2	3	4	5	Pts
1	ACHOURI Ilyas	L	L	L	L			
2	BOUYOUCEF Sofiane	MB	6	2	3			6
3	KERBOUA Ahmed Amir	S	1	6	1			1
6	OUMESSAD Mohamed Amine	MB	3					
7	KERBOUA Ali (C)	WS		11				
8	IKKEN Boudjemaa	OS	4	3	4			19
9	HAMIMES Abderraouf	S						
11	HOSNI Soufiane	WS	5	4	5			11
16	OULD CHERCHALI Islem	MB	3	5	6			2
17	TIZIT Farouk	WS						
18	SOUALEM Billel	WS	2	1	2			7
20	BOUROUBA Youssouf	OS	2	3				

Coach SENNOUN Morad  
Assistant Coach ACHOURI Salim / ASSAM Samir

## TEAM AND PLAYER PERFORMANCES

Won	Total Atts	No.	Name	Scoring Skills	Won	Total Atts	No.	Name
52	96	Total	Team	Spike	33	88	Total	Team
24	39	15	TOY Metin		14	38	8	IKKEN Boudjemaa
10	28	8	GOKGOZ Gokhan		11	18	11	HOSNI Soufiane
8	14	12	UNVER Izzet		5	20	18	SOUALEM Billel
6	36	Total	Team	Block	8	42	Total	Team
4	14	17	ULU Dogukan		3	8	8	IKKEN Boudjemaa
2	9	13	TOSUN Burakhan		2	11	2	BOUYOUCEF Sofiane
					1	5	18	SOUALEM Billel
3	73	Total	Team	Serve	5	70	Total	Team
2	13	8	GOKGOZ Gokhan		2	12	8	IKKEN Boudjemaa
1	15	13	TOSUN Burakhan		1	17	18	SOUALEM Billel
					1	9	16	OULD CHERCHALI Islem
45		Total	Team	Opp. Error	45		Total	Team
106	205	Total	Team	Total	91	200	Total	Team
24	54	15	TOY Metin	Best Scorer	19	58	8	IKKEN Boudjemaa

## LEGEND

(C)	Team Captain	n	Starting line-up where n= starting pos	L	Substitute Libero	nn	Substitute where nn = shirt number
Atts	Attempts	L	Libero	MB	Middle Blocker	No.	Shirt Number
Opp.	Opponent	OS	Opposite Spiker	Pos	Playing Position	Pts	Points scored
S	Setter	WS	Wing Spiker				
-	-						



SUN 26 JUN 2022

Start Time 21:00 - End Time 23:30

Match Duration 2h30

Spectators 400

Results

P2

FRA vs GRE  
3 2

Team	Sets	1	2	3	4	5	Total
FRA	3	30	22	20	25	18	115
GRE	2	28	25	25	19	16	113
	Playing Time	34min	28min	28min	25min	23min	2h18

First Referee: Abderazek HARIZ (TUN)

Second Referee: Ismail YILDIRIM (TUR)

FRA - France

No.	Name	Pos.	1	2	3	4	5	Pts
1	MOTTA PAES Kellian	S	1	2	1			13
2	RAMON Luca	L	L	L	L	L	L	
3	NEVOT Thomas	S		1	1	2	1	1
6	LAWANI Ibrahim	OS		12	10			
7	PANOU Joachim	WS	5	6	5			4
8	REBEYROL Francois	WS		7				1
9	BASIC Lukas (C)	WS	2	3	2	3	2	26
10	FAURE Theo	OS	4	5	4	5	4	30
11	POTHRON Antoine	WS			7	6	5	12
12	KABA Kevin	MB	3	4	3			2
13	GUEYE Mousse	MB	6	1	6	1	6	10
15	ROEHRIG Simon	MB			12	4	3	5

**Coach** CHATELON Pierre-Yves  
**Assistant Coach** AUDABRAM Olivier / ROYER Thomas

GRE - Greece

No.	Name	Pos.	1	2	3	4	5	Pts
1	CHANDRINOS Aristeidis	L	L	L	L	L	L	
5	CHANDRINOS Spyridon	WS						
7	PETREAS Georgios (C)	MB	1	2	1	1	1	7
8	TZIOUMAKAS Georgios	OS	2	3	2	2	2	29
11	KASAMPALIS Stavros	S				16		1
12	VOULKIDIS Theodoros	MB	4	5	4	4	4	12
13	ANDREOPOULOS Charalampos	WS	6	15	3			2
15	RAPTIS Alexandros	WS	3	4	13	3	3	11
16	KOMITODIS Dimitrios	S	5	6	5	5	5	
19	MOUCLIAS Dimitrios	OS				8		1
22	LINARDOS Dimosthenis	MB					16	
23	CHAKAS Spyridon	WS	13	1	6	6	6	13

**Coach** BONINFANTE Dante  
**Assistant Coach** PAPI Samuele

TEAM AND PLAYER PERFORMANCES

Won	Total Atts	No.	Name	Scoring Skills	Won	Total Atts	No.	Name
79	163	Total	Team	Spike	59	152	Total	Team
27	45	10	FAURE Theo		27	57	8	TZIOUMAKAS Georgios
24	51	9	BASIC Lukas		12	26	23	CHAKAS Spyridon
11	18	11	POTHRON Antoine		8	27	15	RAPTIS Alexandros
12	65	Total	Team	Block	12	64	Total	Team
3	13	10	FAURE Theo		5	13	7	PETREAS Georgios
3	13	13	GUEYE Mousse		5	18	12	VOULKIDIS Theodoros
2	8	15	ROEHRIG Simon		2	10	8	TZIOUMAKAS Georgios
2	115	Total	Team	Serve	5	113	Total	Team
1	29	9	BASIC Lukas		3	18	15	RAPTIS Alexandros
1	7	15	ROEHRIG Simon		1	2	11	KASAMPALIS Stavros
					1	18	23	CHAKAS Spyridon
68		Total	Team	Opp. Error	75		Total	Team
161	343	Total	Team	Total	151	329	Total	Team
30	72	10	FAURE Theo	Best Scorer	29	86	8	TZIOUMAKAS Georgios

LEGEND

(C) Team Captain	n Starting line-up where n= starting pos	L Substitute Libero	nn Substitute where nn = shirt number
Atts Attempts	L Libero	MB Middle Blocker	No. Shirt Number
Opp. Opponent	OS Opposite Spiker	Pos Playing Position	Pts Points scored
S Setter	WS Wing Spiker		



MON 27 JUN 2022

Start Time 18:00 - End Time 19:14

Match Duration 1h14

Spectators 3800

**Results**
**P2**
**ALG vs FRA**  
**0 3**

Team	Sets	1	2	3	Total
ALG	0	18	18	16	52
FRA	3	25	25	25	75
	<b>Playing Time</b>	23min	24min	21min	1h8

First Referee: Alessandro CERRA (ITA)

Second Referee: Ioannis IOANNIDIS (GRE)

**ALG - Algeria**

No.	Name	Pos.	1	2	3	4	5	Pts
1	ACHOURI Ilyas	L	L	L	L			
2	BOUYOUCEF Sofiane	MB	4	3	3			5
3	KERBOUA Ahmed Amir	WS	2	1	1			
6	OUMESSAD Mohamed Amine	MB	1					1
7	KERBOUA Ali (C)	WS						
8	IKKEN Boudjemaa	OS	5	4	4			8
9	HAMIMES Abderraouf	S	3	3	3			
11	HOSNI Soufiane	WS		2	5			6
16	OULD CHERCHALI Islem	MB		6	6			1
17	TIZIT Farouk	WS	6	5				6
18	SOUALEM Billel	WS	3		2			3
20	BOUROUBA Yousseuf	OS	2	8				3

**Coach** SENNOUN Morad  
**Assistant Coach** ACHOURI Salim / ASSAM Samir

**FRA - France**

No.	Name	Pos.	1	2	3	4	5	Pts
1	MOTTA PAES Kellian	S		10				1
2	RAMON Luca	L	L	L	L			
3	NEVOT Thomas	S	1	2	1			3
6	LAWANI Ibrahim	OS	12	3				
7	PANOU Joachim	WS	5	6	5			12
8	REBEYROL Francois	WS						
9	BASIC Lukas (C)	WS	2	3	2			13
10	FAURE Theo	OS	4	5	4			14
11	POTHRON Antoine	WS	7					
12	KABA Kevin	MB	3	4	3			5
13	GUEYE Mousse	MB	6	1	6			7
15	ROEHRIG Simon	MB			13			1

**Coach** CHATELON Pierre-Yves  
**Assistant Coach** AUDABRAM Olivier / ROYER Thomas

**TEAM AND PLAYER PERFORMANCES**

Won	Total Atts	No.	Name	Scoring Skills	Won	Total Atts	No.	Name
26	64	Total	Team	Spike	46	72	Total	Team
8	20	8	IKKEN Boudjemaa		12	20	9	BASIC Lukas
5	10	11	HOSNI Soufiane		12	18	10	FAURE Theo
4	8	17	TIZIT Farouk		11	19	7	PANOU Joachim
6	27	Total	Team	Block	6	28	Total	Team
2	2	17	TIZIT Farouk		2	4	10	FAURE Theo
2	14	2	BOUYOUCEF Sofiane		2	11	13	GUEYE Mousse
1	2	11	HOSNI Soufiane		1	5	7	PANOU Joachim
1	53	Total	Team	Serve	4	74	Total	Team
1	3	20	BOUROUBA Yousseuf		2	21	3	NEVOT Thomas
					1	15	9	BASIC Lukas
					1	2	1	MOTTA PAES Kellian
38		Total	Team	Opp. Error	45		Total	Team
71	144	Total	Team	Total	101	174	Total	Team

8	30	8	IKKEN Boudjemaa	Best Scorer	14	29	10	FAURE Theo
---	----	---	-----------------	-------------	----	----	----	------------

**LEGEND**

(C)	Team Captain	n	Starting line-up where n= starting pos	L	Substitute Libero	nn	Substitute where nn = shirt number
Atts	Attempts	L	Libero	MB	Middle Blocker	No.	Shirt Number
Opp.	Opponent	OS	Opposite Spiker	Pos	Playing Position	Pts	Points scored
S	Setter	WS	Wing Spiker				



MON 27 JUN 2022

Start Time 20:58 - End Time 23:18

Match Duration 2h19

Spectators 400

**Results**
**P2**
**GRE vs TUR**  
**3 2**

Team	Sets	1	2	3	4	5	Total
GRE	3	25	22	25	23	15	110
TUR	2	23	25	8	25	13	94
	<b>Playing Time</b>	29min	27min	20min	33min	19min	2h10

First Referee: Wael KANDIL (EGY)

Second Referee: Edgar SEROLE (BOT)

**GRE - Greece**

No.	Name	Pos.	1	2	3	4	5	Pts
1	CHANDRINOS Aristeidis	L	L	L	L	L	L	
5	CHANDRINOS Spyridon	WS						
7	PETREAS Georgios (C)	MB	1	2	1	2	2	8
8	TZIOUMAKAS Georgios	OS	2					1
11	KASAMPALIS Stavros	S						
12	VOULKIDIS Theodoros	MB	4	5	4	5	5	9
13	ANDREOPOULOS Charalampos	WS						
15	RAPTIS Alexandros	WS	3	4	3	4	4	20
16	KOMITODIS Dimitrios	S	5	6	5	6	6	1
19	MOUCHLIAS Dimitrios	OS	8	3	2	3	3	27
22	LINARDOS Dimosthenis	MB		16		7		
23	CHAKAS Spyridon	WS	6	1	6	1	1	15

**Coach** BONINFANTE Dante  
**Assistant Coach** CHRISTOFIDELIS Konstantinos / PAPI

**TUR - Turkiye**

No.	Name	Pos.	1	2	3	4	5	Pts
1	EKSI Aslan	S	6	6	6	2	2	2
3	DOGRULUK Oguzhan	WS			8			1
5	YATGIN Ogulcan	S	1		1			
8	GOKGOZ Gokhan	WS	4	4	4	6	6	13
9	HACIOGLU Mehmet	WS	17		12	12	3	10
10	OGBAI Cansin Enaboifo	OS			15	15	5	3
12	UNVER Izzet	WS	1	1	1	3		4
13	TOSUN Burakhan	MB	2	2	2	4	4	9
15	TOY Metin	OS	3	3	3	5	10	19
17	ULU Dogukan	MB	5	5	5	1	1	7
19	BAYRAKTAR Berkay	L	L	L	L	L	L	
20	CENGIZ Mustafa	MB			17			

**Coach** OZKAN Hakan  
**Assistant Coach** ERYILMAZ Kerem

**TEAM AND PLAYER PERFORMANCES**

Won	Total Atts	No. Name	Scoring Skills	Won	Total Atts	No. Name
57	131	<b>Total Team</b>	<b>Spike</b>	47	119	<b>Total Team</b>
19	40	15 RAPTIS Alexandros		17	35	15 TOY Metin
19	41	19 MOUCHLIAS Dimitrios		8	11	9 HACIOGLU Mehmet
10	23	23 CHAKAS Spyridon		8	25	8 GOKGOZ Gokhan
13	52	<b>Total Team</b>	<b>Block</b>	16	65	<b>Total Team</b>
6	13	19 MOUCHLIAS Dimitrios		4	14	17 ULU Dogukan
4	16	12 VOULKIDIS Theodoros		4	7	8 GOKGOZ Gokhan
1	4	15 RAPTIS Alexandros		3	9	12 UNVER Izzet
11	110	<b>Total Team</b>	<b>Serve</b>	5	94	<b>Total Team</b>
4	21	23 CHAKAS Spyridon		2	13	15 TOY Metin
2	13	12 VOULKIDIS Theodoros		1	16	17 ULU Dogukan
2	18	19 MOUCHLIAS Dimitrios		1	14	8 GOKGOZ Gokhan
76		<b>Total Team</b>	<b>Opp. Error</b>	63		<b>Total Team</b>
157	293	<b>Total Team</b>	<b>Total</b>	131	278	<b>Total Team</b>

27	72	19 MOUCHLIAS Dimitrios	<b>Best Scorer</b>	19	52	15 TOY Metin
----	----	------------------------	--------------------	----	----	--------------

**LEGEND**

(C)	Team Captain	n	Starting line-up where n= starting pos	L	Substitute Libero	nn	Substitute where nn = shirt number
Atts	Attempts	L	Libero	MB	Middle Blocker	No.	Shirt Number
Opp.	Opponent	OS	Opposite Spiker	Pos	Playing Position	Pts	Points scored
S	Setter	WS	Wing Spiker				



TUE 28 JUN 2022

Start Time 18:45 - End Time 20:24

Match Duration 1h39

Spectators 4500

**Results**
**P2**
**GRE vs ALG**  
**0 3**

Team	Sets	1	2	3	Total
GRE	0	24	20	19	63
ALG	3	26	25	25	76
	Playing Time	32min	33min	28min	1h33

First Referee: Sébastien JACOB (FRA)

Second Referee: Ismail YILDIRIM (TUR)

GRE - Greece								
No.	Name	Pos.	1	2	3	4	5	Pts
1	CHANDRINOS Aristeidis	L	L	L	L			
5	CHANDRINOS Spyridon	WS	15	4	1			4
6	KOMITOU DIS Dimitrios	S						
7	PETREAS Georgios (C)	MB	2					4
8	TZIOUMAKAS Georgios	OS						
11	KASAMPALIS Stavros	S	6	6	3			3
12	VOULKIDIS Theodoros	MB	5	5	2			3
13	ANDREOPOULOS Charalampos	WS		23	4			4
15	RAPTIS Alexandros	WS	4					2
19	MOUCHLIAS Dimitrios	OS	3	3	6			19
22	LINARDOS Dimosthenis	MB		2	5			4
23	CHAKAS Spyridon	WS	1	1				6

ALG - Algeria								
No.	Name	Pos.	1	2	3	4	5	Pts
1	ACHOURI Ilyas	L	L	L	L			
2	BOUYOUCEF Sofiane	MB	2	2				2
3	KERBOUA Ahmed Amir	WS	6	6	6			
6	OUMESSAD Mohamed Amine	MB		2	2			2
7	KERBOUA Ali (C)	WS	11					
8	IKKEN Boudjemaa	OS	3	3	3			21
9	HAMIMES Abderraouf	S						
11	HOSNI Soufiane	WS	4	4	4			10
16	OULD CHERCHALI Islem	MB	5	5	5			10
17	TIZIT Farouk	WS						
18	SOUALEM Billel	WS	1	1	1			10
20	BOUROUBA Youssouf	OS						

**Coach** BONINFANTE Dante  
**Assistant Coach** CHRISTOFIDELIS Konstantinos / PAPI

**Coach** SENNOUN Morad  
**Assistant Coach** ACHOURI Salim / ASSAM Samir

**TEAM AND PLAYER PERFORMANCES**

Won	Total Atts	No.	Name	Scoring Skills	Won	Total Atts	No.	Name
39	92	Total	Team	Spike	43	79	Total	Team
18	30	19	MOUCHLIAS Dimitrios		17	28	8	IKKEN Boudjemaa
5	11	23	CHAKAS Spyridon		9	22	18	SOUALEM Billel
4	13	13	ANDREOPOULOS Charalampos		9	14	11	HOSNI Soufiane
6	35	Total	Team	Block	11	36	Total	Team
3	6	7	PETREAS Georgios		3	9	8	IKKEN Boudjemaa
1	9	22	LINARDOS Dimosthenis		3	6	16	OULD CHERCHALI Islem
1	3	23	CHAKAS Spyridon		2	4	2	BOUYOUCEF Sofiane
4	64	Total	Team	Serve	1	75	Total	Team
1	7	5	CHANDRINOS Spyridon		1	16	8	IKKEN Boudjemaa
1	9	22	LINARDOS Dimosthenis					
1	9	19	MOUCHLIAS Dimitrios					
14		Total	Team	Opp. Error	21		Total	Team
63	191	Total	Team	Total	76	190	Total	Team

19	39	19	MOUCHLIAS Dimitrios	Best Scorer	21	53	8	IKKEN Boudjemaa
----	----	----	---------------------	-------------	----	----	---	-----------------

**LEGEND**

(C) Team Captain

Atts Attempts

Opp. Opponent

S Setter

n Starting line-up where n= starting pos

L Libero

OS Opposite Spiker

WS Wing Spiker

L Substitute Libero

MB Middle Blocker

Pos Playing Position

nn Substitute where nn = shirt number

No. Shirt Number

Pts Points scored



TUE 28 JUN 2022

Start Time 21:15 - End Time 22:42

Match Duration 1h27

Spectators 1000

**Results**
**P2**
**TUR vs FRA**  
**0 3**

Team	Sets	1	2	3	Total
TUR	0	21	22	18	61
FRA	3	25	25	25	75
	<b>Playing Time</b>	28min	29min	24min	1h21

First Referee: Abderazek HARIZ (TUN)

Second Referee: Alessandro CERRA (ITA)

**TUR - Turkiye**

No.	Name	Pos.	1	2	3	4	5	Pts
1	EKSI Aslan	S	6	6	6			
3	DOGRULUK Oguzhan	WS						
5	YATGIN Ogulcan	S		1				
8	GOKGOZ Gokhan	WS	4	4	4			9
9	HACIOGLU Mehmet	WS	1	1	1			7
10	OGBAI Cansin Enaboifo	OS			15			1
12	UNVER Izzet (C)	WS						
13	TOSUN Burakhan	MB	2	2	2			6
15	TOY Metin	OS	3	3	3			9
17	ULU Dogukan	MB	5	5				6
19	BAYRAKTAR Berkay	L	L	L	L			
20	CENGIZ Mustafa	MB			5			2

**Coach** OZKAN Hakan  
**Assistant Coach** ERYILMAZ Kerem

**FRA - France**

No.	Name	Pos.	1	2	3	4	5	Pts
1	MOTTA PAES Kellian	S		12				
2	RAMON Luca	L	L	L	L			
3	NEVOT Thomas	S	1	2	1			2
6	LAWANI Ibrahim	OS						
7	PANOJ Joachim	WS	5	6	5			15
8	REBEYROL Francois	WS						
9	BASIC Lukas (C)	WS	2	3	2			10
10	FAURE Theo	OS	4	5	4			20
11	POTHRON Antoine	WS						
12	KABA Kevin	MB	3	4	3			5
13	GUEYE Mousse	MB	6	1	6			6
15	ROEHRIG Simon	MB			12			1

**Coach** CHATELON Pierre-Yves  
**Assistant Coach** AUDABRAM Olivier / ROYER Thomas

**TEAM AND PLAYER PERFORMANCES**

Won	Total Atts	No. Name	Scoring Skills	Won	Total Atts	No. Name
27	73	<b>Total Team</b>	<b>Spike</b>	45	87	<b>Total Team</b>
7	14	9 HACIOGLU Mehmet		16	27	10 FAURE Theo
7	20	8 GOKGOZ Gokhan		12	26	7 PANOJ Joachim
5	21	15 TOY Metin		10	22	9 BASIC Lukas
9	38	<b>Total Team</b>	<b>Block</b>	8	30	<b>Total Team</b>
5	8	17 ULU Dogukan		3	10	13 GUEYE Mousse
2	7	13 TOSUN Burakhan		3	8	12 KABA Kevin
1	6	8 GOKGOZ Gokhan		1	5	3 NEVOT Thomas
4	62	<b>Total Team</b>	<b>Serve</b>	6	74	<b>Total Team</b>
3	13	15 TOY Metin		3	18	10 FAURE Theo
1	13	8 GOKGOZ Gokhan		3	10	7 PANOJ Joachim
21		<b>Total Team</b>	<b>Opp. Error</b>	16		<b>Total Team</b>
61	173	<b>Total Team</b>	<b>Total</b>	75	191	<b>Total Team</b>

9	40	15 TOY Metin	<b>Best Scorer</b>	20	49	10 FAURE Theo
---	----	--------------	--------------------	----	----	---------------

**LEGEND**

(C)	Team Captain	n	Starting line-up where n= starting pos	L	Substitute Libero	nn	Substitute where nn = shirt number
Atts	Attempts	L	Libero	MB	Middle Blocker	No.	Shirt Number
Opp.	Opponent	OS	Opposite Spiker	Pos	Playing Position	Pts	Points scored
S	Setter	WS	Wing Spiker				



SUN 26 JUN 2022

Start Time 12:00 - End Time 13:27

Match Duration 1h27

**Results**
**P2**
**TUN vs SRB**
**3 0**

Team	Sets	1	2	3	Total
TUN	3	25	25	25	75
SRB	0	22	15	20	57
	<b>Playing Time</b>	34min	22min	25min	1h21

First Referee: Alessandro CERRA (ITA)

Second Referee: Abed KHELFOUN (ALG)

**TUN - Tunisia**

No.	Name	Pos.	1	2	3	4	5	Pts
2	KADHI Ahmed	MB	2	1	2			13
3	BEN SLIMENE Khaled (C)	S	3	2	3			8
6	BEN OTHMEN MILADI Mohamed Ali	WS	1	6	1			8
7	KARAMOSLI Elyes	WS	2					
8	ABDELHEDI Yassine	WS						
9	AGREBI Omar	MB	5	4	5			6
10	NAGGA Hamza	OS	6	5	6			16
12	BENNOUR Rami	S						
13	MBARKI Selim	MB						
18	BONGUI Ali	OS						
19	BOUGUERRA Aymen	WS	4	3	4			8
20	HMISSI Saddam	L	L	L	L			1

Coach GIACOBBE Antonio / MESSELMANI

Assistant Coach

**SRB - Serbia**

No.	Name	Pos.	1	2	3	4	5	Pts
1	NIKOLIC Uros	MB			3			1
7	POLOMAC Andrej	S	6	6	4			4
10	NIKOLIC Dusan	WS			1			5
16	STEFANOVIC Aleksandar	MB	2	2	6			4
19	NEGIC Stefan	L	L	L	L			1
23	VUCICEVIC Bozidar	OS	3	3				9
24	SKAKIC Stefan	WS	1	1				2
25	TADIC Luka	WS		28	2			3
28	MARINOVIC Lazar (C)	WS	4	4				3
34	BAJANDIC Lazar	WS		24	5			3
35	RUDIC Andrej	MB	5	5				3

Coach ZAKIC Igor

Assistant Coach VLAJIC Filip / KOVACEVIC Nenad

**TEAM AND PLAYER PERFORMANCES**

Won	Total Atts	No.	Name	Scoring Skills	Won	Total Atts	No.	Name
43	71	Total	Team	Spike	27	64	Total	Team
14	23	10	NAGGA Hamza		7	18	23	VUCICEVIC Bozidar
10	13	2	KADHI Ahmed		5	10	10	NIKOLIC Dusan
7	14	6	BEN OTHMEN MILADI Mohamed Ali		3	10	28	MARINOVIC Lazar
11	30	Total	Team	Block	6	28	Total	Team
4	6	9	AGREBI Omar		2	4	35	RUDIC Andrej
3	9	2	KADHI Ahmed		1	3	7	POLOMAC Andrej
2	4	3	BEN SLIMENE Khaled		1	4	16	STEFANOVIC Aleksandar
6	73	Total	Team	Serve	5	59	Total	Team
3	18	3	BEN SLIMENE Khaled		2	16	16	STEFANOVIC Aleksandar
1	8	19	BOUGUERRA Aymen		1	7	7	POLOMAC Andrej
1	15	10	NAGGA Hamza		1	7	23	VUCICEVIC Bozidar
15		Total	Team	Opp. Error	19		Total	Team
75	174	Total	Team	Total	57	151	Total	Team
16	41	10	NAGGA Hamza	Best Scorer	9	28	23	VUCICEVIC Bozidar

**LEGEND**

(C) Team Captain

Atts Attempts

Opp. Opponent

S Setter

n Starting line-up where n= starting pos

L Libero

OS Opposite Spiker

WS Wing Spiker

L Substitute Libero

MB Middle Blocker

Pos Playing Position

nn Substitute where nn = shirt number

No. Shirt Number

Pts Points scored



SUN 26 JUN 2022

Start Time 15:00 - End Time 17:11

Match Duration 2h11

Spectators 1000

**Results**
**P2**
**CRO vs ESP**  
**3 1**

Team	Sets	1	2	3	4	Total
CRO	3	27	25	22	28	102
ESP	1	25	23	25	26	99
	<b>Playing Time</b>	27min	29min	31min	35min	2h2

First Referee: Wael KANDIL (EGY)

Second Referee: Sébastien JACOB (FRA)

CRO - Croatia								
No.	Name	Pos.	1	2	3	4	5	Pts
1	VISIC Petar	S	6	6	6	6		4
3	PERIC Stipe	MB						
4	NIKACEVIC Kruno	MB	5	5	5	5		11
6	BAKONJI Bernard	S						
7	SEDLACEK Marko (C)	WS						
9	HANZIC Tino	WS	19	19	1	4		2
10	SESTAN Filip	WS	4	4	4	1		16
11	DIRLIC Petar	OS	3	3	3	14		21
13	PERVAN Hrvoje	L	L	L	L	L		
14	MITRASINOVIC Tomislav	OS	1	1	11	3		4
17	MIHALJ Ivan	MB	2	2	2	2		13
19	ZELJKOVIC Ivan	WS	1	1				2

**Coach** ENARD Cedric  
**Assistant Coach** COSKOVIC Tomislav / QUERIN Gael

ESP - Spain								
No.	Name	Pos.	1	2	3	4	5	Pts
1	IRIBARNE F.	WS				3		
3	RODRIGUEZ PEREZ Victor	WS	6	5	6	5		9
6	RUIZ MIRA Borja	MB	1	6	1	6		14
7	RAMON FERRAGUT Jordi	WS	3	2				4
8	LARRANAGA LEDO Unai	L	L	L	L	L		
12	DIEDHIOU DIATTA Jean Pascal	MB	4	3	4	3		11
15	GIMENEZ HERNANDEZ Jose Maria	WS		7	3	2		7
16	VILLENA A. (C)	OS	5	4	5	4		28
20	GIMENO RUBIO Alvaro	OS	77			21		
21	MARTIN PEREZ Cesar	S	12	12	77	1		3
24	LOPEZ ALACIO David	MB						
77	DE AMO FERNANDEZ Miguel Angel	S	2	1	2			1

**Coach** RIVERA RODRIGUEZ Miguel  
**Assistant Coach** MOLTO CARBONELL Jose Luis

**TEAM AND PLAYER PERFORMANCES**

Won	Total Atts	No.	Name	Scoring Skills	Won	Total Atts	No.	Name
50	111	Total	Team	Spike	62	131	Total	Team
14	36	11	DIRLIC Petar		27	53	16	VILLENA RODRIGUEZ Andres Jesus
10	24	10	SESTAN Filip		9	11	6	RUIZ MIRA Borja
9	11	4	NIKACEVIC Kruno		8	23	3	RODRIGUEZ PEREZ Victor
17	62	Total	Team	Block	11	46	Total	Team
5	10	10	SESTAN Filip		4	12	6	RUIZ MIRA Borja
4	17	17	MIHALJ Ivan		3	14	12	DIEDHIOU DIATTA Jean Pascal
3	8	11	DIRLIC Petar		2	4	21	MARTIN PEREZ Cesar
6	100	Total	Team	Serve	4	101	Total	Team
4	19	11	DIRLIC Petar		1	10	21	MARTIN PEREZ Cesar
1	20	17	MIHALJ Ivan		1	8	7	RAMON FERRAGUT Jordi
1	16	10	SESTAN Filip		1	12	6	RUIZ MIRA Borja
62		Total	Team	Opp. Error	68		Total	Team
135	273	Total	Team	Total	145	278	Total	Team

21	63	11	DIRLIC Petar	Best Scorer	28	73	16	VILLENA RODRIGUEZ Andres Jesus
----	----	----	--------------	-------------	----	----	----	--------------------------------

**LEGEND**

(C)	Team Captain	n	Starting line-up where n= starting pos	L	Substitute Libero	nn	Substitute where nn = shirt number
Atts	Attempts	L	Libero	MB	Middle Blocker	No.	Shirt Number
Opp.	Opponent	OS	Opposite Spiker	Pos	Playing Position	Pts	Points scored
S	Setter	WS	Wing Spiker				





MON 27 JUN 2022

Start Time 11:59 - End Time 13:30

Match Duration 1h30

Spectators 400

**Results**
**P2**
**SRB vs CRO**  
**0 3**

Team	Sets	1	2	3	Total
SRB	0	20	19	28	67
CRO	3	25	25	30	80
	<b>Playing Time</b>	24min	27min	33min	1h26

First Referee: Abed KHELFOUN (ALG)

Second Referee: Abderazek HARIZ (TUN)

SRB - Serbia								
No.	Name	Pos.	1	2	3	4	5	Pts
1	NIKOLIC Uros	MB	2	1	2			6
7	POLOMAC Andrej	S	6	5	6			1
10	NIKOLIC Dusan	WS			7			
16	STEFANOVIC Aleksandar	MB			35			
19	NEGIC Stefan	L	L	L	L			
23	VUCICEVIC Bozidar	OS	3	2	3			17
24	SKAKIC Stefan	WS						
25	TADIC Luka	WS	4	3	4			12
28	MARINOVIC Lazar (C)	WS	1	6	1			5
34	BAJANDIC Lazar	WS						
35	RUDIC Andrej	MB	5	4	5			4

CRO - Croatia								
No.	Name	Pos.	1	2	3	4	5	Pts
1	VISIC Petar	S	6	6	6			1
3	PERIC Stipe	MB			9			
4	NIKACEVIC Kruno	MB	5	5	5			5
6	BAKONJI Bernard	S						
7	SEDLACEK Marko (C)	WS						
9	HANZIC Tino	WS	4	4	4			5
10	SESTAN Filip	WS	1	1	1			24
11	DIRLIC Petar	OS	3	3	3			17
13	PERVAN Hrvoje	L	L	L	L			
14	MITRASINOVIC Tomislav	OS			1			
17	MIHALJ Ivan	MB	2	2	2			7
19	ZELJKOVIC Ivan	WS						

**Coach** ZAKIC Igor  
**Assistant Coach** VLAJIC Filip / KOVACEVIC Nenad

**Coach** ENARD Cedric  
**Assistant Coach** COSKOVIC Tomislav / QUERIN Gael

**TEAM AND PLAYER PERFORMANCES**

Won	Total Atts	No.	Name	Scoring Skills	Won	Total Atts	No.	Name
39	83	Total	Team	Spike	43	72	Total	Team
16	31	23	VUCICEVIC Bozidar		18	26	10	SESTAN Filip
12	23	25	TADIC Luka		15	24	11	DIRLIC Petar
5	13	28	MARINOVIC Lazar		4	5	17	MIHALJ Ivan
4	27	Total	Team	Block	11	34	Total	Team
2	12	1	NIKOLIC Uros		3	8	17	MIHALJ Ivan
1	3	7	POLOMAC Andrej		2	6	11	DIRLIC Petar
1	7	35	RUDIC Andrej		2	13	4	NIKACEVIC Kruno
2	69	Total	Team	Serve	5	78	Total	Team
1	19	1	NIKOLIC Uros		4	18	10	SESTAN Filip
1	10	23	VUCICEVIC Bozidar		1	12	4	NIKACEVIC Kruno
42		Total	Team	Opp. Error	56		Total	Team
87	179	Total	Team	Total	115	184	Total	Team

17	42	23	VUCICEVIC Bozidar	Best Scorer	24	47	10	SESTAN Filip
----	----	----	-------------------	-------------	----	----	----	--------------

**LEGEND**

(C)	Team Captain	n	Starting line-up where n= starting pos	L	Substitute Libero	nn	Substitute where nn = shirt number
Atts	Attempts	L	Libero	MB	Middle Blocker	No.	Shirt Number
Opp.	Opponent	OS	Opposite Spiker	Pos	Playing Position	Pts	Points scored
S	Setter	WS	Wing Spiker				



MON 27 JUN 2022

Start Time 15:00 - End Time 16:21

Match Duration 1h21

Spectators 1000

## Results

P2

**ESP vs TUN**  
**3 0**

Team	Sets	1	2	3	Total
ESP	3	25	25	25	75
TUN	0	17	17	22	56
	<b>Playing Time</b>	23min	24min	28min	1h15

First Referee: Ismail YILDIRIM (TUR)

Second Referee: Tomislav POPOVIC (SRB)

ESP - Spain								
No.	Name	Pos.	1	2	3	4	5	Pts
1	IRIBARNE F.	WS	4	3	4			7
3	RODRIGUEZ PEREZ Victor	WS						
6	RUIZ MIRA Borja	MB	2	1	2			6
7	RAMON FERRAGUT Jordi	WS	1	6	1			12
8	LARRANAGA LEDO Unai	L	L	L	L			
12	DIEDHIOU DIATTA Jean Pascal	MB	5	4	5			7
15	GIMENEZ HERNANDEZ Jose Maria	WS						
16	VILLENA A. (C)	OS	6	5	6			15
20	GIMENO RUBIO Alvaro	OS	77	77				
21	MARTIN PEREZ Cesar	S		6				
24	LOPEZ ALACIO David	MB						
77	DE AMO FERNANDEZ Miguel Angel	OS	3	2	3			

TUN - Tunisia								
No.	Name	Pos.	1	2	3	4	5	Pts
2	KADHI Ahmed	MB	6	1	13			2
3	BEN SLIMENE Khaled (C)	S	1	2	1			2
6	BEN OTHMEN MILADI Mohamed Ali	WS	5	6	5			6
7	KARAMOSLI Elyes	WS	2	6	2			2
8	ABDELHEDI Yassine	WS						
9	AGREBI Omar	MB	3	4	3			7
10	NAGGA Hamza	OS	4	5	9			
12	BENNOUR Rami	S						
13	MBARKI Selim	MB			6			2
18	BONGUI Ali	OS	10	10	4			12
19	BOUGUERRA Aymen	WS	2	3				8
20	HMISSI Saddam	L	L	L	L			

**Coach** RIVERA RODRIGUEZ Miguel  
**Assistant Coach** MOLTO CARBONELL Jose Luis

**Coach** GIACOBBE Antonio / MESSELMANI  
**Assistant Coach**

### TEAM AND PLAYER PERFORMANCES

Won	Total Atts	No. Name	Scoring Skills	Won	Total Atts	No. Name
39	60	<b>Total Team</b>	<b>Spike</b>	33	65	<b>Total Team</b>
13	19	16 VILLENA RODRIGUEZ Andres Jesus		12	17	18 BONGUI Ali
11	17	7 RAMON FERRAGUT Jordi		7	13	19 BOUGUERRA Aymen
6	6	6 RUIZ MIRA Borja		4	13	6 BEN OTHMEN MILADI Mohamed Ali
4	17	<b>Total Team</b>	<b>Block</b>	6	22	<b>Total Team</b>
2	7	12 DIEDHIOU DIATTA Jean Pascal		3	7	9 AGREBI Omar
1	3	1 IRIBARNE F.		2	5	6 BEN OTHMEN MILADI Mohamed Ali
1	1	16 VILLENA RODRIGUEZ Andres Jesus		1	2	3 BEN SLIMENE Khaled
4	73	<b>Total Team</b>	<b>Serve</b>	2	58	<b>Total Team</b>
1	12	1 IRIBARNE F.		1	13	3 BEN SLIMENE Khaled
1	11	7 RAMON FERRAGUT Jordi		1	7	19 BOUGUERRA Aymen
1	11	16 VILLENA RODRIGUEZ Andres Jesus				
28		<b>Total Team</b>	<b>Opp. Error</b>	15		<b>Total Team</b>
75	150	<b>Total Team</b>	<b>Total</b>	56	145	<b>Total Team</b>

15	31	16 VILLENA RODRIGUEZ Andres Jesus	<b>Best Scorer</b>	12	27	18 BONGUI Ali
----	----	-----------------------------------	--------------------	----	----	---------------

#### LEGEND

(C) Team Captain

Atts Attempts

Opp. Opponent

S Setter

n Starting line-up where n= starting pos

L Libero

OS Opposite Spiker

WS Wing Spiker

L Substitute Libero

MB Middle Blocker

Pos Playing Position

nn Substitute where nn = shirt number

No. Shirt Number

Pts Points scored



TUE 28 JUN 2022

Start Time 12:00 - End Time 14:36

Match Duration 2h36

Spectators 500

Results

P2

ESP vs SRB  
3 2

Team	Sets	1	2	3	4	5	Total
ESP	3	22	25	23	25	19	114
SRB	2	25	19	25	23	17	109
	Playing Time	29min	26min	35min	30min	24min	2h24

First Referee: Ioannis IOANNIDIS (GRE)

Second Referee: Wael KANDIL (EGY)

ESP - Spain								
No.	Name	Pos.	1	2	3	4	5	Pts
1	IRIBARNE F.	WS	2	1	1	1	1	12
3	RODRIGUEZ PEREZ Victor	WS	1					
6	RUIZ MIRA Borja	MB	6	5	5	5	5	16
7	RAMON FERRAGUT Jordi	WS	5	4	4	4	4	14
8	LARRANAGA LEDO Unai	L	L	L	L	L	L	
12	DIEDHIU DIATTA Jean Pascal	MB	3	2	2	2		6
15	GIMENEZ HERNANDEZ Jose Maria	WS			1	1		
16	VILLENA A. (C)	OS	4	3	3	3	3	19
20	GIMENO RUBIO Alvaro	OS	77				77	
21	MARTIN PEREZ Cesar	S	16		12		6	
24	LOPEZ ALACIO David	MB		12		12	2	1
77	DE AMO FERNANDEZ Miguel Angel	S	1	6	6	6	6	4

SRB - Serbia								
No.	Name	Pos.	1	2	3	4	5	Pts
1	NIKOLIC Uros	MB	4	5	4	5		4
7	POLOMAC Andrej	S	5	6	5	6	6	1
10	NIKOLIC Dusan	WS	2	3	2	3	3	22
16	STEFANOVIC Aleksandar	MB	1	2	1	2	2	13
19	NEGIC Stefan	L	L	L	L	L	L	
23	VUCICEVIC Bozidar	OS	7				7	
24	SKAKIC Stefan	WS	6	1	6	1	1	18
25	TADIC Luka	WS	3	4	3	4	4	18
28	MARINOVIC Lazar (C)	WS						
34	BAJANDIC Lazar	WS			24	24		
35	RUDIC Andrej	MB	1	1	5			1

**Coach** RIVERA RODRIGUEZ Miguel  
**Assistant Coach** MOLTO CARBONELL Jose Luis

**Coach** VLAJIC Filip  
**Assistant Coach** VLAJIC Filip

TEAM AND PLAYER PERFORMANCES

Won	Total Atts	No.	Name	Scoring Skills	Won	Total Atts	No.	Name
58	109	Total	Team	Spike	63	129	Total	Team
18	41	16	VILLENA RODRIGUEZ Andres Jesus		19	37	10	NIKOLIC Dusan
13	28	7	RAMON FERRAGUT Jordi		17	39	24	SKAKIC Stefan
11	14	6	RUIZ MIRA Borja		15	31	25	TADIC Luka
13	69	Total	Team	Block	9	46	Total	Team
5	21	6	RUIZ MIRA Borja		3	15	16	STEFANOVIC Aleksandar
2	7	77	DE AMO FERNANDEZ Miguel Angel		2	7	25	TADIC Luka
2	4	1	IRIBARNE F.		1	6	24	SKAKIC Stefan
1	113	Total	Team	Serve	5	110	Total	Team
1	16	12	DIEDHIU DIATTA Jean Pascal		3	20	10	NIKOLIC Dusan
					1	21	16	STEFANOVIC Aleksandar
					1	15	25	TADIC Luka
86		Total	Team	Opp. Error	80		Total	Team
158	291	Total	Team	Total	157	285	Total	Team

19	66	16	VILLENA RODRIGUEZ Andres Jesus	Best Scorer	22	61	10	NIKOLIC Dusan
----	----	----	--------------------------------	-------------	----	----	----	---------------

LEGEND

(C)	Team Captain	n	Starting line-up where n= starting pos	L	Substitute Libero	nn	Substitute where nn = shirt number
Atts	Attempts	L	Libero	MB	Middle Blocker	No.	Shirt Number
Opp.	Opponent	OS	Opposite Spiker	Pos	Playing Position	Pts	Points scored
S	Setter	WS	Wing Spiker				



TUE 28 JUN 2022

Start Time 15:30 - End Time 18:05

Match Duration 2h35

Spectators 2800

**Results**
**P2**
**TUN vs CRO**  
**3 2**

Team	Sets	1	2	3	4	5	Total
TUN	3	22	25	20	25	23	115
CRO	2	25	21	25	19	21	111
	<b>Playing Time</b>	25min	29min	27min	26min	36min	2h23

First Referee: Edgar SEROLE (BOT)

Second Referee: Abed KHELFOUN (ALG)

**TUN - Tunisia**

No.	Name	Pos.	1	2	3	4	5	Pts
2	KADHI Ahmed	MB	2	1	2	1	1	13
3	BEN SLIMENE Khaled	S	3	2	3	2	2	3
6	BEN OTHMEN MILADI Mohamed Ali	WS	1	6	1			8
7	KARAMOSLI Elyes	WS		2		6	6	4
8	ABDELHEDI Yassine	WS				2		
9	AGREBI Omar	MB	5	4	5	4	4	6
10	NAGGA Hamza	OS	6	5	6	5	5	31
12	BENNOUR Rami	S						
13	MBARKI Selim	MB						
18	BONGUI Ali	OS	9				10	1
19	BOUGUERRA Aymen	WS	4	3	4	3	3	19
20	HIMISSI Saddam	L	L	L	L	L	L	

**Coach**

GIACOBBE Antonio / MESSELMANI

**Assistant Coach**
**CRO - Croatia**

No.	Name	Pos.	1	2	3	4	5	Pts
1	VISIC Petar	S	6	6	6	6	6	3
3	PERIC Stipe	MB			2	2	2	2
4	NIKACEVIC Kruno	MB	5	5				5
6	BAKONJI Bernard	S						
7	SEDLACEK Marko (C)	WS	4	4	4			16
9	HANZIC Tino	WS			1	4	4	8
10	SESTAN Filip	WS	1	1		1	1	14
11	DIRLIC Petar	OS	3	3			1	7
13	PERVAN Hrvoje	L	L	L	L	L	L	
14	MITRASINOVIC Tomislav	OS	1		3	3	3	14
17	MIHALJ Ivan	MB	2	2	5	5	5	8
19	ZELJKOVIC Ivan	WS						

**Coach**

ENARD Cedric

**Assistant Coach**

COSKOVIC Tomislav / QUERIN Gael

**TEAM AND PLAYER PERFORMANCES**

Won	Total Atts	No. Name	Scoring Skills	Won	Total Atts	No. Name
69	139	<b>Total Team</b>	<b>Spike</b>	57	126	<b>Total Team</b>
29	49	10 NAGGA Hamza		12	23	14 MITRASINOVIC Tomislav
15	35	19 BOUGUERRA Aymen		12	26	7 SEDLACEK Marko
12	17	2 KADHI Ahmed		12	26	10 SESTAN Filip
8	49	<b>Total Team</b>	<b>Block</b>	14	67	<b>Total Team</b>
3	14	9 AGREBI Omar		5	18	17 MIHALJ Ivan
2	12	10 NAGGA Hamza		3	14	4 NIKACEVIC Kruno
1	7	2 KADHI Ahmed		2	6	7 SEDLACEK Marko
8	115	<b>Total Team</b>	<b>Serve</b>	6	111	<b>Total Team</b>
3	28	19 BOUGUERRA Aymen		2	15	14 MITRASINOVIC Tomislav
2	23	3 BEN SLIMENE Khaled		2	11	7 SEDLACEK Marko
1	4	18 BONGUI Ali		1	12	10 SESTAN Filip
74		<b>Total Team</b>	<b>Opp. Error</b>	70		<b>Total Team</b>
159	303	<b>Total Team</b>	<b>Total</b>	147	304	<b>Total Team</b>
31	74	10 NAGGA Hamza	<b>Best Scorer</b>	16	43	7 SEDLACEK Marko

**LEGEND**

(C) Team Captain

Atts Attempts

Opp. Opponent

S Setter

n Starting line-up where n= starting pos

L Libero

OS Opposite Spiker

WS Wing Spiker

L Substitute Libero

MB Middle Blocker

Pos Playing Position

nn Substitute where nn = shirt number

No. Shirt Number

Pts Points scored



## Results Table - Final Round

P4

As of MON 4 JUL 2022 at 22:10

Match	Phase	Date	Teams	Sets	Points per Set					Total Points	Match Duration	Spectators
					1	2	3	4	5			
31	Quarter-finals	THU 30 JUN 2022	ITA vs TUR	3 - 0	25 - 15	25 - 16	25 - 15			75 - 46	1:11	400
33	Quarter-finals	THU 30 JUN 2022	EGY vs ESP	2 - 3	25 - 23	21 - 25	25 - 18	22 - 25	9 - 15	102 - 106	2:30	500
35	Quarter-finals	THU 30 JUN 2022	FRA vs TUN	3 - 1	26 - 28	25 - 20	25 - 17	25 - 23		101 - 88	2:05	3000
37	Quarter-finals	THU 30 JUN 2022	CRO vs GRE	3 - 0	25 - 19	25 - 19	25 - 22			75 - 60	1:27	2000
41	Semifinals 5-8	FRI 1 JUL 2022	TUR vs GRE	3 - 1	25 - 19	25 - 15	21 - 25	25 - 21		96 - 80	1:45	400
42	Semifinals 5-8	FRI 1 JUL 2022	EGY vs TUN	1 - 3	27 - 25	22 - 25	18 - 25	23 - 25		90 - 100	2:05	800
45	Final 7th-8th Place	SAT 2 JUL 2022	GRE vs EGY	3 - 1	25 - 21	23 - 25	25 - 23	25 - 22		98 - 91	2:06	80
46	Final 5th-6th Place	SAT 2 JUL 2022	TUR vs TUN	3 - 1	25 - 23	21 - 25	25 - 19	25 - 22		96 - 89	1:54	600
49	Semi-finals	SAT 2 JUL 2022	ITA vs CRO	1 - 3	24 - 26	22 - 25	25 - 21	24 - 26		95 - 98	2:27	2500
50	Semi-finals	SAT 2 JUL 2022	ESP vs FRA	3 - 0	25 - 21	25 - 22	25 - 22			75 - 65	1:36	2500
52	Bronze-medal Match	MON 4 JUL 2022	ITA vs FRA	3 - 1	22 - 25	25 - 20	25 - 15	31 - 29		103 - 89	1:56	1200
54	Gold-medal Match	MON 4 JUL 2022	CRO vs ESP	3 - 0	25 - 22	30 - 28	25 - 20			80 - 70	1:39	3000

Statistics of	Average match duration	Average spectators	Total spectators
Preliminary	1h46	1213	18200
Final Rounds	1h54	1415	16980
Tournament	1h49	1303	35180

### Quarterfinal Round Semifinal Round Final Round

#### ITA - Italy

Match 31, 30 JUN 10:00

TUR - Turkiye

ITA - Italy 3 - 0

Match 49, 2 JUL 16:30

CRO - Croatia

Match 37, 30 JUN 19:00

GRE - Greece

CRO - Croatia 3 - 0

Match 54, 4 JUL 20:00

CRO 3 - 0

1 CRO - Croatia

EGY - Egypt

Match 33, 30 JUN 13:00

ESP - Spain

ESP - Spain 3 - 2

Match 50, 2 JUL 19:30

ESP - Spain 3 - 0

2 ESP - Spain

FRA - France

Match 35, 30 JUN 16:00

TUN - Tunisia

FRA - France 3 - 1

ITA - Italy

Match 52, 4 JUL 13:00

FRA - France

ITA 3 - 1

3 ITA - Italy

4 FRA - France



## Results Table - Final Round

P4

As of MON 4 JUL 2022 at 22:10

<b>TUR - Turkiye</b>			
Match 41, 1 JUL 16:00	<b>TUR - Turkiye 3 - 1</b>		
<b>GRE - Greece</b>		<b>TUR 3 - 1</b>	5 <b>TUR - Turkiye</b>
Match 46, 2 JUL 19:00	<b>TUN - Tunisia 3 - 1</b>		
<b>EGY - Egypt</b>			6 <b>TUN - Tunisia</b>
Match 42, 1 JUL 19:00	<b>TUN - Tunisia 3 - 1</b>		
<b>TUN - Tunisia</b>			
	<b>GRE - Greece</b>		
	Match 45, 2 JUL 16:00	<b>GRE 3 - 1</b>	7 <b>GRE - Greece</b>
	<b>EGY - Egypt</b>		
			8 <b>EGY - Egypt</b>

### LEGEND

**Ax** x (x=1-4) ranked team from pool A    **Bx** x (x=1-4) ranked team from pool B



THU 30 JUN 2022

Start Time 9:58 - End Time 11:10

Match Duration 1h11

Spectators 400

**Results**
**P2**
**ITA vs TUR**  
**3 0**

Team	Sets	1	2	3	Total
ITA	3	25	25	25	75
TUR	0	15	16	15	46
	<b>Playing Time</b>	21min	23min	22min	1h7

First Referee: Abed KHELFOUN (ALG)

Second Referee: Sébastien JACOB (FRA)

ITA - Italy								
No.	Name	Pos.	1	2	3	4	5	Pts
2	FERRATO Leonardo	S						
3	RECINE Francesco	WS	3	2	3			13
4	CROSATO Federico	MB						
8	POL Alberto	WS						
10	FALASCHI Marco (C)	S	2	1	2			4
11	GARDINI Davide	WS						
14	MAGALINI Giulio	WS	6	5	6			12
15	DI MARTINO Gabriele	MB	4	3	4			6
18	GIRONI Fabrizio	WS	5	4	5			15
21	SCHIRO Andrea	OS						
23	CATANIA Damiano	L	L	L	L			
25	VITELLI Marco	MB	1	6	1			5

TUR - Turkiye								
No.	Name	Pos.	1	2	3	4	5	Pts
1	EKSI Aslan	S	2		5			
3	DOGRULUK Oguzhan	WS	8					
5	YATGIN Ogulcan	S	1	6	6			1
8	GOKGOZ Gokhan	WS	6	9	4			2
9	HACIOGLU Mehmet	WS	3	4	1			6
10	OGBAI Cansin Enaboifo	OS		15				3
12	UNVER Izzet (C)	WS	9	1				3
13	TOSUN Burakhan	MB	4	2	2			3
15	TOY Metin	OS	5	3	3			6
17	ULU Dogukan	MB	1	5	5			5
19	BAYRAKTAR Berkay	L	L	L	L			
20	CENGIZ Mustafa	MB						

**Coach** FANIZZA Vincenzo  
**Assistant Coach** ANDREONI Francesco / DI PINTO Adriano

**Coach** OZKAN Hakan  
**Assistant Coach** ERYILMAZ Kerem

**TEAM AND PLAYER PERFORMANCES**

Won	Total Atts	No. Name	Scoring Skills	Won	Total Atts	No. Name
43	69	<b>Total Team</b>	<b>Spike</b>	22	69	<b>Total Team</b>
14	21	18 GIRONI Fabrizio		5	15	15 TOY Metin
11	17	14 MAGALINI Giulio		5	9	17 ULU Dogukan
10	18	3 RECINE Francesco		5	15	9 HACIOGLU Mehmet
8	26	<b>Total Team</b>	<b>Block</b>	5	30	<b>Total Team</b>
4	11	15 DI MARTINO Gabriele		3	10	13 TOSUN Burakhan
2	6	3 RECINE Francesco		1	2	5 YATGIN Ogulcan
1	3	10 FALASCHI Marco		1	3	12 UNVER Izzet
4	74	<b>Total Team</b>	<b>Serve</b>	2	47	<b>Total Team</b>
2	20	10 FALASCHI Marco		1	8	15 TOY Metin
1	10	3 RECINE Francesco		1	8	9 HACIOGLU Mehmet
1	15	14 MAGALINI Giulio				
20		<b>Total Team</b>	<b>Opp. Error</b>	17		<b>Total Team</b>
75	169	<b>Total Team</b>	<b>Total</b>	46	146	<b>Total Team</b>

15	36	18 GIRONI Fabrizio	<b>Best Scorer</b>	6	25	15 TOY Metin
----	----	--------------------	--------------------	---	----	--------------

**LEGEND**

(C)	Team Captain	n	Starting line-up where n= starting pos	L	Substitute Libero	nn	Substitute where nn = shirt number
Atts	Attempts	L	Libero	MB	Middle Blocker	No.	Shirt Number
Opp.	Opponent	OS	Opposite Spiker	Pos	Playing Position	Pts	Points scored
S	Setter	WS	Wing Spiker				



THU 30 JUN 2022

Start Time 18:58 - End Time 20:25

Match Duration 1h27

Spectators 2000

**Results**
**P2**
**CRO vs GRE**  
**3 0**

Team	Sets	1	2	3	Total
CRO	3	25	25	25	75
GRE	0	19	19	22	60
	<b>Playing Time</b>	23min	26min	30min	1h19

First Referee: Wael KANDIL (EGY)

Second Referee: Tomislav POPOVIC (SRB)

CRO - Croatia								
No.	Name	Pos.	1	2	3	4	5	Pts
1	VISIC Petar	S	6	6	6			2
3	PERIC Stipe	MB						
4	NIKACEVIC Kruno	MB	5	5	5			10
6	BAKONJI Bernard	S						
7	SEDLACEK Marko (C)	WS	4	4	4			12
9	HANZIC Tino	WS						
10	SESTAN Filip	WS	1	1	1			12
11	DIRLIC Petar	OS	3	3	3			12
13	PERVAN Hrvoje	L	L	L	L			
14	MITRASINOVIC Tomislav	OS						
17	MIHALJ Ivan	MB	2	2	2			7
19	ZELJKOVIC Ivan	WS						

GRE - Greece								
No.	Name	Pos.	1	2	3	4	5	Pts
1	CHANDRINOS Aristeidis	L	L	L	L			
5	CHANDRINOS Spyridon	WS						
7	PETREAS Georgios (C)	MB	2	1	2			2
8	TZIOUMAKAS Georgios	OS	3	2				6
11	KASAMPALIS Stavros	S		16	6			1
12	VOULKIDIS Theodoros	MB	5	4	5			7
13	ANDREOPOULOS Charalampos	WS	15	3	4			4
15	RAPTIS Alexandros	WS	4					1
16	KOMITODIS Dimitrios	S	6	5	11			1
19	MOUCHLIAS Dimitrios	OS		8	3			7
22	LINARDOS Dimosthenis	MB						
23	CHAKAS Spyridon	WS	1	6	1			9

**Coach** ENARD Cedric  
**Assistant Coach** COSKOVIC Tomislav / QUERIN Gael

**Coach** BONINFANTE Dante  
**Assistant Coach** CHRISTOFIDELIS Konstantinos / PAPI

**TEAM AND PLAYER PERFORMANCES**

Won	Total Atts	No. Name	Scoring Skills	Won	Total Atts	No. Name
39	77	<b>Total Team</b>	<b>Spike</b>	33	81	<b>Total Team</b>
12	23	11 DIRLIC Petar		9	18	23 CHAKAS Spyridon
9	19	7 SELDACEK Marko		6	11	12 VOULKIDIS Theodoros
9	20	10 SESTAN Filip		6	11	19 MOUCHLIAS Dimitrios
12	48	<b>Total Team</b>	<b>Block</b>	3	29	<b>Total Team</b>
4	13	17 MIHALJ Ivan		1	2	16 KOMITODIS Dimitrios
3	11	4 NIKACEVIC Kruno		1	2	8 TZIOUMAKAS Georgios
3	4	7 SELDACEK Marko		1	6	12 VOULKIDIS Theodoros
4	74	<b>Total Team</b>	<b>Serve</b>	2	61	<b>Total Team</b>
2	11	4 NIKACEVIC Kruno		1	12	7 PETREAS Georgios
2	20	10 SESTAN Filip		1	7	19 MOUCHLIAS Dimitrios
20		<b>Total Team</b>	<b>Opp. Error</b>	22		<b>Total Team</b>
75	199	<b>Total Team</b>	<b>Total</b>	60	171	<b>Total Team</b>

12	45	11 DIRLIC Petar	<b>Best Scorer</b>	9	29	23 CHAKAS Spyridon
----	----	-----------------	--------------------	---	----	--------------------

**LEGEND**

(C)	Team Captain	n	Starting line-up where n= starting pos	L	Substitute Libero	nn	Substitute where nn = shirt number
Atts	Attempts	L	Libero	MB	Middle Blocker	No.	Shirt Number
Opp.	Opponent	OS	Opposite Spiker	Pos	Playing Position	Pts	Points scored
S	Setter	WS	Wing Spiker				





THU 30 JUN 2022

Start Time 12:57 - End Time 15:27

Match Duration 2h30

Spectators 500

**Results**
**P2**
**EGY vs ESP**  
**2 3**

Team	Sets	1	2	3	4	5	Total
EGY	2	25	21	25	22	9	102
ESP	3	23	25	18	25	15	106
	<b>Playing Time</b>	34min	26min	28min	32min	16min	2h19

First Referee: Ismail YILDIRIM (TUR)

Second Referee: Abderazek HARIZ (TUN)

**EGY - Egypt**

No.	Name	Pos.	1	2	3	4	5	Pts
1	ELSAIED Ahmed	S	1	1	1	1	1	
6	HASSAN Mohamed	L	L	L	L	L	L	
7	ALI Seifeldin	OS				1	1	1
8	EISSA Abdelrahman	WS	2	2	2	2	2	13
10	MASOUD Mohamed (C)	MB	6	6	3	3	3	8
13	KHATER Mohamed	MB	3	3	6	6	6	7
14	MORGAN Youssef	S					18	
16	SOLIMAN Mohamed	MB	1	1				
18	SHFIK Ahmed	WS	4	4	4	4	4	23
19	MOHAMED Zyad	OS						
21	AWAD Youssef	WS				23	5	5
23	OMAR Ahmed	WS	5	5	5	5		11

**Coach** ELHOSSARY Hassan  
**Assistant Coach** ASHOUR Ahmed

**ESP - Spain**

No.	Name	Pos.	1	2	3	4	5	Pts
1	IRIBARNE F.	WS	6	1	2	5	6	15
3	RODRIGUEZ PEREZ Victor	WS	7	1		1	1	
6	RUIZ MIRA Borja	MB	4	5	6	3	4	10
7	RAMON FERRAGUT Jordi	WS	3	4	5	2	3	19
8	LARRANAGA LEDO Unai	L	L	L	L	L	L	
12	DIEDHIOU DIATTA Jean Pascal	MB	1	2	3	6	1	7
15	GIMENEZ HERNANDEZ Jose Maria	WS						
16	VILLENA A. (C)	OS	2	3	4	1	2	29
20	GIMENO RUBIO Alvaro	OS	77	77		77	77	
21	MARTIN PEREZ Cesar	S		12			12	
24	LOPEZ ALACIO David	MB			12			
77	DE AMO FERNANDEZ Miguel Angel	OS	5	6	1	4	5	1

**Coach** RIVERA RODRIGUEZ Miguel  
**Assistant Coach** MOLTO CARBONELL Jose Luis

**TEAM AND PLAYER PERFORMANCES**

Won	Total Atts	No. Name	Scoring Skills	Won	Total Atts	No. Name
57	114	<b>Total Team</b>	<b>Spike</b>	61	112	<b>Total Team</b>
21	37	18 SHFIK Ahmed		28	49	16 VILLENA RODRIGUEZ Andres Jesus
13	29	8 EISSA Abdelrahman		14	25	7 RAMON FERRAGUT Jordi
7	16	10 MASOUD Mohamed		10	19	1 IRIBARNE F.
7	49	<b>Total Team</b>	<b>Block</b>	12	46	<b>Total Team</b>
3	7	23 OMAR Ahmed		4	10	1 IRIBARNE F.
2	9	13 KHATER Mohamed		3	11	12 DIEDHIOU DIATTA Jean Pascal
1	3	21 AWAD Youssef		3	12	6 RUIZ MIRA Borja
4	103	<b>Total Team</b>	<b>Serve</b>	8	105	<b>Total Team</b>
2	19	18 SHFIK Ahmed		3	17	7 RAMON FERRAGUT Jordi
1	17	23 OMAR Ahmed		2	17	6 RUIZ MIRA Borja
1	14	13 KHATER Mohamed		1	20	1 IRIBARNE F.
34		<b>Total Team</b>	<b>Opp. Error</b>	25		<b>Total Team</b>
102	266	<b>Total Team</b>	<b>Total</b>	106	263	<b>Total Team</b>
23	62	18 SHFIK Ahmed	<b>Best Scorer</b>	29	69	16 VILLENA RODRIGUEZ Andres Jesus

**LEGEND**

(C)	Team Captain	n	Starting line-up where n= starting pos	L	Substitute Libero	nn	Substitute where nn = shirt number
Atts	Attempts	L	Libero	MB	Middle Blocker	No.	Shirt Number
Opp.	Opponent	OS	Opposite Spiker	Pos	Playing Position	Pts	Points scored
S	Setter	WS	Wing Spiker				



THU 30 JUN 2022

Start Time 16:13 - End Time 18:18

Match Duration 2h5

Spectators 3000

Results

P2

FRA vs TUN  
3 1

Team	Sets	1	2	3	4	Total
FRA	3	26	25	25	25	101
TUN	1	28	20	17	23	88
	Playing Time	33min	28min	25min	28min	1h54

First Referee: Alessandro CERRA (ITA)

Second Referee: Ioannis IOANNIDIS (GRE)

FRA - France

No.	Name	Pos.	1	2	3	4	5	Pts
1	MOTTA PAES Kellian	S	10					
2	RAMON Luca	L	L	L	L	L		
3	NEVOT Thomas	S	1	2	1	2		2
6	LAWANI Ibrahim	OS	3					1
7	PANOU Joachim	WS	5	6				5
8	REBEYROL Francois	WS						
9	BASIC Lukas	WS	2	3	2	3		20
10	FAURE Theo (C)	OS	4	5	4	5		19
11	POTHRON Antoine	WS	7	7	5	6		13
12	KABA Kevin	MB	3	4	3	4		3
13	GUEYE Mousse	MB	6	1	6	1		6
15	ROEHRIG Simon	MB				12		

**Coach** CHATELON Pierre-Yves  
**Assistant Coach** AUDABRAM Olivier / ROYER Thomas

TUN - Tunisia

No.	Name	Pos.	1	2	3	4	5	Pts
2	KADHI Ahmed	MB	3	3	3	6		7
3	BEN SLIMENE Khaled (C)	S	4	4	4	1		4
6	BEN OTHMEN MILADI Mohamed Ali	WS	2	2	7	5		5
7	KARAMOSLI Elyes	WS	9	9	2			
8	ABDELHEDI Yassine	WS		2		9		
9	AGREBI Omar	MB	6	6	6	3		12
10	NAGGA Hamza	S	1	1	1	4		17
12	BENNOUR Rami	OS						
13	MBARKI Selim	MB						
18	BONGUI Ali	OS	2		10	10		2
19	BOUGUERRA Aymen	WS	5	5	5	2		17
20	HMISSI Saddam	L	L	L	L	L		

**Coach** GIACOBBE Antonio / MESSELMANI  
**Assistant Coach**

TEAM AND PLAYER PERFORMANCES

Won	Total Atts	No. Name	Scoring Skills	Won	Total Atts	No. Name
53	107	Total Team	Spike	50	115	Total Team
18	29	9 BASIC Lukas		17	30	19 BOUGUERRA Aymen
16	37	10 FAURE Theo		16	40	10 NAGGA Hamza
11	21	11 POTHRON Antoine		6	9	9 AGREBI Omar
12	40	Total Team	Block	8	54	Total Team
5	8	13 GUEYE Mousse		5	19	9 AGREBI Omar
2	8	10 FAURE Theo		2	13	3 BEN SLIMENE Khaled
2	6	11 POTHRON Antoine		1	14	2 KADHI Ahmed
4	100	Total Team	Serve	6	89	Total Team
2	7	7 PANOU Joachim		3	12	6 BEN OTHMEN MILADI Mohamed Ali
1	16	9 BASIC Lukas		1	3	18 BONGUI Ali
1	21	10 FAURE Theo		1	15	10 NAGGA Hamza
32		Total Team	Opp. Error	24		Total Team
101	247	Total Team	Total	88	258	Total Team
20	48	9 BASIC Lukas	Best Scorer	17	46	19 BOUGUERRA Aymen

LEGEND

(C)	Team Captain	n	Starting line-up where n= starting pos	L	Substitute Libero	nn	Substitute where nn = shirt number
Atts	Attempts	L	Libero	MB	Middle Blocker	No.	Shirt Number
Opp.	Opponent	OS	Opposite Spiker	Pos	Playing Position	Pts	Points scored
S	Setter	WS	Wing Spiker				



SAT 2 JUL 2022

Start Time 16:30 - End Time 18:57

Match Duration 2h27

Spectators 2500

**Results**
**P2**
**ITA vs CRO**
**1 3**

Team	Sets	1	2	3	4	Total
ITA	1	24	22	25	24	95
CRO	3	26	25	21	26	98
	<b>Playing Time</b>	30min	34min	37min	37min	2h18

First Referee: Ismail YILDIRIM (TUR)

Second Referee: Abed KHELFOUN (ALG)

ITA - Italy								
No.	Name	Pos.	1	2	3	4	5	Pts
2	FERRATO Leonardo	S			10	10		
3	RECINE Francesco	WS	6	1	6	5		19
4	CROSATO Federico	MB						
8	POL Alberto	WS		11	11	11		
10	FALASCHI Marco (C)	S	5	6	5	4		6
11	GARDINI Davide	WS	14	4	3	2		12
14	MAGALINI Giulio	WS	3			18		4
15	DI MARTINO Gabriele	MB	1	2	1	6		8
18	GIRONI Fabrizio	WS	2	3	2	1		18
21	SCHIRO Andrea	OS						
23	CATANIA Damiano	L	L	L	L	L		
25	VITELLI Marco	MB	4	5	4	3		9

CRO - Croatia								
No.	Name	Pos.	1	2	3	4	5	Pts
1	VISIC Petar	S	6	6	6	6		1
3	PERIC Stipe	MB						
4	NIKACEVIC Kruno	MB	5	5	5	5		9
6	BAKONJI Bernard	S						
7	SEDLACEK Marko (C)	WS	4	4	4	4		16
9	HANZIC Tino	WS						
10	SESTAN Filip	WS	1	1	1	1		10
11	DIRLIC Petar	OS	3	3	3	3		33
13	PERVAN Hrvoje	L	L	L	L	L		
14	MITRASINOVIC Tomislav	OS	1	1	1			
17	MIHALJ Ivan	MB	2	2	2	2		5
19	ZELJKOVIC Ivan	WS						

**Coach** FANIZZA Vincenzo  
**Assistant Coach** ANDREONI Francesco / DI PINTO Adriano

**Coach** ENARD Cedric  
**Assistant Coach** COSKOVIC Tomislav / QUERIN Gael

**TEAM AND PLAYER PERFORMANCES**

Won	Total Atts	No.	Name	Scoring Skills	Won	Total Atts	No.	Name
63	131	Total	Team	Spike	54	106	Total	Team
17	36	3	RECINE Francesco		26	40	11	DIRLIC Petar
16	39	18	GIRONI Fabrizio		12	33	7	SEDLACEK Marko
11	20	11	GARDINI Davide		8	19	10	SESTAN Filip
6	50	Total	Team	Block	17	63	Total	Team
2	12	15	DI MARTINO Gabriele		7	17	11	DIRLIC Petar
2	10	10	FALASCHI Marco		3	12	17	MIHALJ Ivan
1	2	14	MAGALINI Giulio		2	4	7	SEDLACEK Marko
7	95	Total	Team	Serve	3	96	Total	Team
2	17	3	RECINE Francesco		2	21	7	SEDLACEK Marko
2	17	10	FALASCHI Marco		1	17	4	NIKACEVIC Kruno
1	16	18	GIRONI Fabrizio					
19		Total	Team	Opp. Error	24		Total	Team
95	276	Total	Team	Total	98	265	Total	Team

19	59	3	RECINE Francesco	Best Scorer	33	71	11	DIRLIC Petar
----	----	---	------------------	-------------	----	----	----	--------------

**LEGEND**

(C)	Team Captain	n	Starting line-up where n= starting pos	L	Substitute Libero	nn	Substitute where nn = shirt number
Atts	Attempts	L	Libero	MB	Middle Blocker	No.	Shirt Number
Opp.	Opponent	OS	Opposite Spiker	Pos	Playing Position	Pts	Points scored
S	Setter	WS	Wing Spiker				
-	-						



SAT 2 JUL 2022

Start Time 19:48 - End Time 21:24

Match Duration 1h36

Spectators 2500

**Results**
**P2**
**ESP vs FRA**  
**3 0**

Team	Sets	1	2	3	Total
ESP	3	25	25	25	75
FRA	0	21	22	22	65
	<b>Playing Time</b>	26min	33min	29min	1h28

First Referee: Abderazek HARIZ (TUN)

Second Referee: Ioannis IOANNIDIS (GRE)

**ESP - Spain**

No.	Name	Pos.	1	2	3	4	5	Pts
1	IRIBARNE F.	WS	3	3	3			8
3	RODRIGUEZ PEREZ Victor	WS	1	1	1			
6	RUIZ MIRA Borja	MB	1	1	1			3
7	RAMON FERRAGUT Jordi	WS	6	6	6			10
8	LARRANAGA LEDO Unai	L	L	L	L			
12	DIEDHIOU DIATTA Jean Pascal	MB	4	4	4			8
15	GIMENEZ HERNANDEZ Jose Maria	WS						
16	VILLENA A. (C)	OS	5	5	5			24
20	GIMENO RUBIO Alvaro	OS	77	77	77			
21	MARTIN PEREZ Cesar	S	12	12	12			
24	LOPEZ ALACIO David	MB						
77	DE AMO FERNANDEZ Miguel Angel	S	2	2	2			3

**Coach** RIVERA RODRIGUEZ Miguel

**Assistant Coach**
**FRA - France**

No.	Name	Pos.	1	2	3	4	5	Pts
1	MOTTA PAES Kellian	S	12	10	3			2
2	RAMON Luca	L	L	L	L			
3	NEVOT Thomas	S	1	6	6			
6	LAWANI Ibrahim	OS		3	10			4
7	PANOU Joachim	WS	5	4	11			7
8	REBEYROL Francois	WS						
9	BASIC Lukas	WS	2	1	1			9
10	FAURE Theo	OS	4	3	3			10
11	POTHRON Antoine	WS	7	7	4			3
12	KABA Kevin	MB	3	2	2			4
13	GUEYE Mousse	MB	6	5				3
15	ROEHRIG Simon	MB		13	5			4

**Coach** SAPINART Stephane

**Assistant Coach**
**TEAM AND PLAYER PERFORMANCES**

Won	Total Atts	No.	Name	Scoring Skills	Won	Total Atts	No.	Name
47	76	Total	Team	Spike	35	82	Total	Team
20	29	16	VILLENA RODRIGUEZ Andres Jesus		9	19	10	FAURE Theo
9	16	7	RAMON FERRAGUT Jordi		8	19	9	BASIC Lukas
7	11	1	IRIBARNE F.		7	15	7	PANOU Joachim
7	46	Total	Team	Block	6	39	Total	Team
2	13	12	DIEDHIOU DIATTA Jean Pascal		2	11	12	KABA Kevin
2	8	16	VILLENA RODRIGUEZ Andres Jesus		1	3	13	GUEYE Mousse
1	7	6	RUIZ MIRA Borja		1	1	6	LAWANI Ibrahim
2	73	Total	Team	Serve	5	67	Total	Team
2	14	16	VILLENA RODRIGUEZ Andres Jesus		2	6	15	ROEHRIG Simon
					1	5	13	GUEYE Mousse
					1	11	12	KABA Kevin
19		Total	Team	Opp. Error	19		Total	Team
75	195	Total	Team	Total	65	188	Total	Team
24	51	16	VILLENA RODRIGUEZ Andres Jesus	Best Scorer	10	29	10	FAURE Theo

**LEGEND**

(C) Team Captain

Atts Attempts

Opp. Opponent

S Setter

n Starting line-up where n= starting pos

L Libero

OS Opposite Spiker

WS Wing Spiker

L Substitute Libero

MB Middle Blocker

Pos Playing Position

nn Substitute where nn = shirt number

No. Shirt Number

Pts Points scored



FRI 1 JUL 2022  
Start Time 16:00 - End Time 17:45  
Match Duration 1h45  
Spectators 400

## Results

### P2

## TUR vs GRE

### 3 1

Team	Sets	1	2	3	4	Total
TUR	3	25	25	21	25	96
GRE	1	19	15	25	21	80
	<b>Playing Time</b>	24min	22min	25min	25min	1h36

First Referee: Edgar SEROLE (BOT)

Second Referee: Sébastien JACOB (FRA)

TUR - Turkiye								
No.	Name	Pos.	1	2	3	4	5	Pts
1	EKSI Aslan	S	6	6	6	2		1
3	DOGRULUK Oguzhan	WS						
5	YATGIN Ogulcan	S						
8	GOKGOZ Gokhan	WS	4	4	4	6		21
9	HACIOGLU Mehmet	WS				12		
10	OGBAI Cansin Enaboifo	OS						
12	UNVER Izzet (C)	WS	1	1	1	3		11
13	TOSUN Burakhan	MB	2	2	2	4		8
15	TOY Metin	OS	3	3	3	5		21
17	ULU Dogukan	MB	5	5	5	1		9
19	BAYRAKTAR Berkay	L	L	L	L	L		
20	CENGIZ Mustafa	MB						

GRE - Greece								
No.	Name	Pos.	1	2	3	4	5	Pts
5	CHANDRINOS Spyridon	WS		23	4	3		4
7	PETREAS Georgios (C)	MB	5	4	5	4		9
8	TZIOUMAKAS Georgios	OS						
11	KASAMPALIS Stavros	S		16	6	5		1
12	VOULKIDIS Theodoros	MB						
13	ANDREPOULOS Charalampos	WS	-1	-1	-1	-1		
15	RAPTIS Alexandros	WS	4	3				3
16	KOMITOUDIS Dimitrios	S	6	5				
19	MOUCHLIAS Dimitrios	OS	3	2	3	2		18
22	LINARDOS Dimosthenis	MB	2	1	2	1		7
23	CHAKAS Spyridon	WS	1	6	1	6		14

**Coach** OZKAN Hakan  
**Assistant Coach** ERYILMAZ Kerem

**Coach** BONINFANTE Dante  
**Assistant Coach** CHRISTOFIDELIS Konstantinos / PAPI

### TEAM AND PLAYER PERFORMANCES

Won	Total Atts	No. Name	Scoring Skills	Won	Total Atts	No. Name
52	106	<b>Total Team</b>	<b>Spike</b>	50	106	<b>Total Team</b>
17	25	8 GOKGOZ Gokhan		16	31	19 MOUCHLIAS Dimitrios
16	39	15 TOY Metin		13	24	23 CHAKAS Spyridon
9	16	12 UNVER Izzet		7	13	7 PETREAS Georgios
7	53	<b>Total Team</b>	<b>Block</b>	3	39	<b>Total Team</b>
2	11	13 TOSUN Burakhan		1	13	7 PETREAS Georgios
2	12	17 ULU Dogukan		1	6	22 LINARDOS Dimosthenis
2	6	8 GOKGOZ Gokhan		1	4	23 CHAKAS Spyridon
12	94	<b>Total Team</b>	<b>Serve</b>	3	82	<b>Total Team</b>
5	19	15 TOY Metin		2	14	19 MOUCHLIAS Dimitrios
2	23	13 TOSUN Burakhan		1	17	7 PETREAS Georgios
2	13	8 GOKGOZ Gokhan				
25		<b>Total Team</b>	<b>Opp. Error</b>	24		<b>Total Team</b>
96	253	<b>Total Team</b>	<b>Total</b>	80	227	<b>Total Team</b>
21	69	15 TOY Metin	<b>Best Scorer</b>	18	48	19 MOUCHLIAS Dimitrios

### LEGEND

(C)	Team Captain	n	Starting line-up where n= starting pos	L	Substitute Libero	nn	Substitute where nn = shirt number
Atts	Attempts	L	Libero	MB	Middle Blocker	No.	Shirt Number
Opp.	Opponent	OS	Opposite Spiker	Pos	Playing Position	Pts	Points scored
S	Setter	WS	Wing Spiker				
-	-						



FRI 1 JUL 2022  
Start Time 19:00 - End Time 21:05  
Match Duration 2h5  
Spectators 800

## Results

### P2

## EGY vs TUN

### 1 3

Team	Sets	1	2	3	4	Total
EGY	1	27	22	18	23	90
TUN	3	25	25	25	25	100
	Playing Time	28min	28min	29min	31min	1h56

First Referee: Ioannis IOANNIDIS (GRE)

Second Referee: Ismail YILDIRIM (TUR)

EGY - Egypt								
No.	Name	Pos.	1	2	3	4	5	Pts
1	ELSAYED Ahmed	S	6	1	6	2		1
6	HASSAN Mohamed	L	L	L	L	L		
7	ALI Seifeldin	OS				1		5
8	EISSA Abdelrahman	WS	1	2	1	3		9
10	MASOUD Mohamed (C)	MB	2	6	2	1		7
13	KHATER Mohamed	MB	5	3	16	4		4
14	MORGAN Youssef	S					18	
16	SOLIMAN Mohamed	MB	1	13	5	10		3
18	SHFIK Ahmed	WS	3	4	3	5		17
19	MOHAMED Zyad	OS						1
21	AWAD Youssef	WS		8				1
23	OMAR Ahmed	WS	4	5	4	6		20

TUN - Tunisia								
No.	Name	Pos.	1	2	3	4	5	Pts
2	KADHI Ahmed	MB	1	6	1	6		7
3	BEN SLIMENE Khaled (C)	S	2	1	2	1		4
6	BEN OTHMEN MILADI Mohamed Ali	WS	6	5	6	5		11
7	KARAMOSLI Elyes	WS		2	3	2		7
8	ABDELHEDI Yassine	WS	6					
9	AGREBI Omar	MB	4	3	4	3		7
10	NAGGA Hamza	OS	5	4	5	4		23
12	BENNOUR Rami	S						
13	MBARKI Selim	MB						
18	BONGUI Ali	OS		9	2	10		9
19	BOUGUERRA Aymen	WS	3					3
20	HMISSI Saddam	L	L	L	L	L		

**Coach** ELHOSSARY Hassan  
**Assistant Coach** ASHOUR Ahmed

**Coach** GIACOBBE Antonio / MESSELMANI  
**Assistant Coach**

### TEAM AND PLAYER PERFORMANCES

Won	Total Atts	No. Name	Scoring Skills	Won	Total Atts	No. Name
57	109	Total Team	Spike	56	104	Total Team
16	26	23 OMAR Ahmed		18	35	10 NAGGA Hamza
15	30	18 SHFIK Ahmed		11	19	6 BEN OTHMEN MILADI Mohamed Ali
9	21	8 EISSA Abdelrahman		9	14	18 BONGUI Ali
5	50	Total Team	Block	8	56	Total Team
3	11	10 MASOUD Mohamed		2	17	9 AGREBI Omar
2	11	16 SOLIMAN Mohamed		2	18	2 KADHI Ahmed
				1	3	19 BOUGUERRA Aymen
6	91	Total Team	Serve	7	99	Total Team
4	16	23 OMAR Ahmed		4	19	10 NAGGA Hamza
2	17	18 SHFIK Ahmed		1	17	3 BEN SLIMENE Khaled
				1	12	7 KARAMOSLI Elyes
22		Total Team	Opp. Error	29		Total Team
90	250	Total Team	Total	100	259	Total Team
20	47	23 OMAR Ahmed	Best Scorer	23	58	10 NAGGA Hamza

#### LEGEND

(C)	Team Captain	n	Starting line-up where n= starting pos	L	Substitute Libero	nn	Substitute where nn = shirt number
Atts	Attempts	L	Libero	MB	Middle Blocker	No.	Shirt Number
Opp.	Opponent	OS	Opposite Spiker	Pos	Playing Position	Pts	Points scored
S	Setter	WS	Wing Spiker				



MON 4 JUL 2022

Start Time 20:14 - End Time 21:53

Match Duration 1h39

Spectators 3000

Results

P2

CRO vs ESP  
3 0

Team	Sets	1	2	3	Total
CRO	3	25	30	25	80
ESP	0	22	28	20	70
	Playing Time	30min	36min	26min	1h32

First Referee: Abed KHELFOUN (ALG)

Second Referee: Edgar SEROLE (BOT)

CRO - Croatia								
No.	Name	Pos.	1	2	3	4	5	Pts
1	VISIC Petar	S	6	6	6			2
3	PERIC Stipe	MB						
4	NIKACEVIC Krno	MB	5	5	5			5
6	BAKONJI Bernard	S						
7	SEDLACEK Marko (C)	WS	4	4	4			15
9	HANZIC Tino	WS						
10	SESTAN Filip	WS	1	1	1			9
11	DIRLIC Petar	OS	3	3	3			16
13	PERVAN Hrvoje	L	L	L	L			
14	MITRASINOVIC Tomislav	OS	1	1				
17	MIHALJ Ivan	MB	2	2	2			7
19	ZELJKOVIC Ivan	WS						

ESP - Spain								
No.	Name	Pos.	1	2	3	4	5	Pts
1	IRIBARNE F.	WS	5	1				4
3	RODRIGUEZ PEREZ Victor	WS		1	1			4
6	RUIZ MIRA Borja	MB	3	5	5			8
7	RAMON FERRAGUT Jordi	WS	2	4	4			11
8	LARRANAGA LEDO Unai	L	L	L	L			
12	DIEDHIOU DIATTA Jean Pascal	MB	6	2	24			5
15	GIMENEZ HERNANDEZ Jose Maria	WS	7	7				
16	VILLENA A. (C)	OS	1	3	3			17
20	GIMENO RUBIO Alvaro	OS	77		77			
21	MARTIN PEREZ Cesar	S	12	12	16			
24	LOPEZ ALACIO David	MB			2			1
77	DE AMO FERNANDEZ Miguel Angel	OS	4	6	6			1

**Coach** ENARD Cedric  
**Assistant Coach** COSKOVIC Tomislav / QUERIN Gael

**Coach** RIVERA RODRIGUEZ Miguel  
**Assistant Coach** MOLTO CARBONELL Jose Luis

TEAM AND PLAYER PERFORMANCES

Won	Total Atts	No. Name	Scoring Skills	Won	Total Atts	No. Name
40	84	Total Team	Spike	42	88	Total Team
14	31	11 DIRLIC Petar		15	30	16 VILLENA RODRIGUEZ Andres Jesus
9	17	7 SEDLACEK Marko		10	21	7 RAMON FERRAGUT Jordi
8	17	10 SESTAN Filip	Block	5	9	6 RUIZ MIRA Borja
12	41	Total Team		7	38	Total Team
5	8	7 SEDLACEK Marko		2	6	12 DIEDHIOU DIATTA Jean Pascal
2	10	17 MIHALJ Ivan		2	11	16 VILLENA RODRIGUEZ Andres Jesus
2	8	1 VISIC Petar	Serve	1	7	6 RUIZ MIRA Borja
2	79	Total Team		2	71	Total Team
1	16	11 DIRLIC Petar		2	11	6 RUIZ MIRA Borja
1	11	7 SEDLACEK Marko				
26		Total Team	Opp. Error	19		Total Team
80	204	Total Team	Total	70	197	Total Team
16	52	11 DIRLIC Petar	Best Scorer	17	51	16 VILLENA RODRIGUEZ Andres Jesus

LEGEND

(C)	Team Captain	n	Starting line-up where n= starting pos	L	Substitute Libero	nn	Substitute where nn = shirt number
Atts	Attempts	L	Libero	MB	Middle Blocker	No.	Shirt Number
Opp.	Opponent	OS	Opposite Spiker	Pos	Playing Position	Pts	Points scored
S	Setter	WS	Wing Spiker				
-	-						



MON 4 JUL 2022

Start Time 13:00 - End Time 14:56

Match Duration 1h56

Spectators 1200

**Results**
**P2**
**ITA vs FRA**  
**3 1**

Team	Sets	1	2	3	4	Total
ITA	3	22	25	25	31	103
FRA	1	25	20	15	29	89
	<b>Playing Time</b>	23min	25min	24min	35min	1h47

First Referee: Abderazek HARIZ (TUN)

Second Referee: Dejan ROGIC (SRB)

ITA - Italy								
No.	Name	Pos.	1	2	3	4	5	Pts
2	FERRATO Leonardo	S	10	10		10		
3	RECINE Francesco	WS	1	1	2	1		10
4	CROSATO Federico	MB			15			
8	POL Alberto	WS						
10	FALASCHI Marco (C)	S	6	6	1	6		4
11	GARDINI Davide	WS						
14	MAGALINI Giulio	WS	4	4	5	4		15
15	DI MARTINO Gabriele	MB	2	2	3	2		2
18	GIRONI Fabrizio	WS	3	3	4	3		23
21	SCHIRO Andrea	OS			18			
23	CATANIA Damiano	L	L	L	L	L		
25	VITELLI Marco	MB	5	5	6	5		7

FRA - France								
No.	Name	Pos.	1	2	3	4	5	Pts
1	MOTTA PAES Kellian	S		10	3	1		2
2	RAMON Luca	L	L	L	L	L		
3	NEVOT Thomas	S	5	5	5			3
6	LAWANI Ibrahim	OS		3	10	4		7
7	PANOU Joachim	WS	3	3	3	11		10
8	REBEYROL Francois	WS			7			2
9	BASIC Lukas (C)	WS	6	6	6	2		12
10	FAURE Theo	OS	2	2	2	12		10
11	POTHRON Antoine	WS		7	9	5		3
12	KABA Kevin	MB	1	1	1	3		6
13	GUEYE Mousse	MB	4	4	4			4
15	ROEHRIG Simon	MB			13	6		3

**Coach** FANIZZA Vincenzo  
**Assistant Coach** ANDREONI Francesco / DI PINTO Adriano

**Coach** CHATELON Pierre-Yves  
**Assistant Coach** AUDABRAM Olivier / ROYER Thomas

**TEAM AND PLAYER PERFORMANCES**

Won	Total Atts	No. Name	Scoring Skills	Won	Total Atts	No. Name
49	102	<b>Total Team</b>	<b>Spike</b>	51	117	<b>Total Team</b>
20	37	18 GIRONI Fabrizio		12	24	9 BASIC Lukas
12	25	14 MAGALINI Giulio		9	24	10 FAURE Theo
10	24	3 RECINE Francesco		8	22	7 PANOU Joachim
8	51	<b>Total Team</b>	<b>Block</b>	7	37	<b>Total Team</b>
3	8	18 GIRONI Fabrizio		2	14	12 KABA Kevin
2	10	25 VITELLI Marco		2	3	7 PANOU Joachim
2	6	14 MAGALINI Giulio		1	3	3 NEVOT Thomas
4	102	<b>Total Team</b>	<b>Serve</b>	4	90	<b>Total Team</b>
2	14	10 FALASCHI Marco		1	14	13 GUEYE Mousse
1	12	25 VITELLI Marco		1	6	1 MOTTA PAES Kellian
1	20	14 MAGALINI Giulio		1	6	15 ROEHRIG Simon
42		<b>Total Team</b>	<b>Opp. Error</b>	27		<b>Total Team</b>
103	255	<b>Total Team</b>	<b>Total</b>	89	244	<b>Total Team</b>
23	61	18 GIRONI Fabrizio	<b>Best Scorer</b>	12	36	9 BASIC Lukas

**LEGEND**

 (C) Team Captain  
 Atts Attempts  
 Opp. Opponent  
 S Setter  
 - -

 n Starting line-up where n= starting pos  
 L Libero  
 OS Opposite Spiker  
 WS Wing Spiker  
 L Substitute Libero  
 MB Middle Blocker  
 Pos Playing Position

 nn Substitute where nn = shirt number  
 No. Shirt Number  
 Pts Points scored





SAT 2 JUL 2022  
Start Time 19:00 - End Time 20:54  
Match Duration 1h54  
Spectators 600

## Results

P2

### TUR vs TUN

3 1

Team	Sets	1	2	3	4	Total
TUR	3	25	21	25	25	96
TUN	1	23	25	19	22	89
	Playing Time	25min	28min	25min	27min	1h45

First Referee: Tomislav POPOVIC (SRB)

Second Referee: Edgar SEROLE (BOT)

TUR - Turkiye								
No.	Name	Pos.	1	2	3	4	5	Pts
1	EKSI Aslan	S	2	2	6	6		4
3	DOGRULUK Oguzhan	WS						
5	YATGIN Ogulcan	S						
8	GOKGOZ Gokhan	WS						
9	HACIOGLU Mehmet	WS	6	6	4	4		15
10	ENABOIFO Cansin Ogbai	OS		15				
12	UNVER Izzet (C)	WS	3	3	1	1		6
13	TOSUN Burakhan	MB	4	4	2	2		12
15	TOY Metin	OS	5	5	3	3		14
17	ULU Dogukan	MB	1	1				2
19	BAYRAKTAR Berkay	L	L	L	L	L		
20	CENGIZ Mustafa	MB		17	5	5		7

TUN - Tunisia								
No.	Name	Pos.	1	2	3	4	5	Pts
2	KADHI Ahmed	MB	2	1	1	1		12
3	BEN SLIMENE Khaled (C)	S	3	2	2	2		2
6	BEN OTHMEN MILADI Mohamed Ali	WS			19	6		3
7	KARAMOSLI Elyes	WS	1	6	6			1
8	ABDELHEDI Yassine	WS			7	9		
9	AGREBI Omar	MB			13	4		4
12	BENNOUR Rami	S						
13	MBARKI Selim	MB	5	4	4			7
18	BONGUI Ali	OS	6	5	5	5		25
19	BOUGUERRA Aymen	WS	4	3	3	3		12
20	HMISSI Saddam	L	L	L	L	L		

**Coach** OZKAN Hakan  
**Assistant Coach**

**Coach** GIACOBBE Antonio  
**Assistant Coach** BEN CHEIKH Mehdi

### TEAM AND PLAYER PERFORMANCES

Won	Total Atts	No. Name	Scoring Skills	Won	Total Atts	No. Name
42	103	Total Team	Spike	49	119	Total Team
13	35	15 TOY Metin		21	49	18 BONGUI Ali
13	30	9 HACIOGLU Mehmet		10	24	19 BOUGUERRA Aymen
6	11	13 TOSUN Burakhan		8	10	2 KADHI Ahmed
15	58	Total Team	Block	14	54	Total Team
6	14	13 TOSUN Burakhan		4	7	9 AGREBI Omar
3	6	20 CENGIZ Mustafa		4	9	2 KADHI Ahmed
2	6	17 ULU Dogukan		3	7	18 BONGUI Ali
3	95	Total Team	Serve	3	90	Total Team
1	13	1 EKSI Aslan		1	14	18 BONGUI Ali
1	15	15 TOY Metin		1	14	19 BOUGUERRA Aymen
1	6	20 CENGIZ Mustafa		1	13	13 MBARKI Selim
36		Total Team	Opp. Error	23		Total Team
96	256	Total Team	Total	89	263	Total Team
15	59	9 HACIOGLU Mehmet	Best Scorer	25	70	18 BONGUI Ali

#### LEGEND

(C) Team Captain      n Starting line-up where n= starting pos      L Substitute Libero      nn Substitute where nn = shirt number  
Atts Attempts      L Libero      MB Middle Blocker      No. Shirt Number  
Opp. Opponent      OS Opposite Spiker      Pos Playing Position      Pts Points scored  
S Setter      WS Wing Spiker



SAT 2 JUL 2022  
Start Time 16:00 - End Time 18:06  
Match Duration 2h6  
Spectators 80

## Results

P2

### GRE vs EGY

3 1

Team	Sets	1	2	3	4	Total
GRE	3	25	23	25	25	98
EGY	1	21	25	23	22	91
	Playing Time	27min	30min	29min	31min	1h57

First Referee: Sébastien JACOB (FRA)

Second Referee: Alessandro CERRA (ITA)

GRE - Greece								
No.	Name	Pos.	1	2	3	4	5	Pts
1	CHANDRINOS Aristeidis	L	L	L	L	L		
5	CHANDRINOS Spyridon	WS	4	4	4	4		13
6	KOMITODIS Dimitrios	S						
7	PETREAS Georgios (C)	MB	5	5	5	5		12
8	TZIOUMAKAS Georgios	OS						
11	KASAMPALIS Stavros	S	6	6	6	6		3
12	VOULKIDIS Theodoros	MB						
13	ANDREOPOULOS Charalampos	WS	1	1	1	1		16
15	RAPTIS Alexandros	WS					11	
19	MOUCHLIAS Dimitrios	OS	3	3	3	3		19
22	LINARDOS Dimosthenis	MB	2	2	2	2		8
23	CHAKAS Spyridon	WS						

EGY - Egypt								
No.	Name	Pos.	1	2	3	4	5	Pts
1	ELSAYED Ahmed	S	1	6	1	6		
6	HASSAN Mohamed	L	L	L	L	L		
7	ALI Seifeldin	OS	4	3	4			5
8	EISSA Abdelrahman	WS	16	23	2	1		7
10	MASOUD Mohamed (C)	MB		16	3	2		9
13	KHATER Mohamed	MB	6	5	6	5		11
14	MORGAN Yossef	S	7					
16	SOLIMAN Mohamed	MB	3	2	1			2
18	SHFIK Ahmed	WS	2	4	5	4		22
19	MOHAMED Zyad	OS	1		7	3		7
21	AWAD Youssef	WS						
23	OMAR Ahmed	WS	5	1		1		1

**Coach** BONINFANTE Dante  
**Assistant Coach** PAPI Samuele

**Coach** ELHOSSARY Hassan  
**Assistant Coach** ASHOUR Ahmed

### TEAM AND PLAYER PERFORMANCES

Won	Total Atts	No. Name	Scoring Skills	Won	Total Atts	No. Name
57	106	Total Team	Spike	50	102	Total Team
18	34	19 MOUCHLIAS Dimitrios		18	33	18 SHFIK Ahmed
14	25	13 ANDREOPOULOS Charalampos		8	16	13 KHATER Mohamed
12	23	5 CHANDRINOS Spyridon		7	13	8 EISSA Abdelrahman
8	41	Total Team	Block	9	44	Total Team
3	16	7 PETREAS Georgios		5	7	10 MASOUD Mohamed
3	8	22 LINARDOS Dimosthenis		2	13	13 KHATER Mohamed
1	6	19 MOUCHLIAS Dimitrios		1	3	19 MOHAMED Zyad
6	97	Total Team	Serve	5	92	Total Team
2	19	11 KASAMPALIS Stavros		3	23	18 SHFIK Ahmed
2	19	7 PETREAS Georgios		1	15	13 KHATER Mohamed
1	13	5 CHANDRINOS Spyridon		1	9	7 ALI Seifeldin
27		Total Team	Opp. Error	27		Total Team
98	244	Total Team	Total	91	238	Total Team

19	55	19 MOUCHLIAS Dimitrios	Best Scorer	22	59	18 SHFIK Ahmed
----	----	------------------------	-------------	----	----	----------------

#### LEGEND

(C)	Team Captain	n	Starting line-up where n= starting pos	L	Substitute Libero	nn	Substitute where nn = shirt number
Atts	Attempts	L	Libero	MB	Middle Blocker	No.	Shirt Number
Opp.	Opponent	OS	Opposite Spiker	Pos	Playing Position	Pts	Points scored
S	Setter	WS	Wing Spiker				



## Top Player Ranking by Skill

As of MON 4 JUL 2022 at 22:19

### Best Scores

Rk	NO.	Name	CTRY	Pos.	Spikes	Blocks	Serve	Total
1	16	VILLENA RODRIGUEZ Andres Jesus	ESP	OS	121	7	4	132
2	11	DIRLIC Petar	CRO	OS	88	13	5	106
3	10	FAURE Theo	FRA	OS	89	8	6	103
4	15	TOY Metin	TUR	OS	80	1	12	93
5	19	MOUCHLIAS Dimitrios	GRE	OS	78	7	6	91
6	9	BASIC Lukas	FRA	WS	84	3	3	90
7	10	NAGGA Hamza	TUN	OS	77	4	6	87
8	10	SESTAN Filip	CRO	WS	65	12	8	85
9	18	SHFIK Ahmed	EGY	WS	69	5	8	82
10	3	RECINE Francesco	ITA	WS	66	4	7	77
11	18	GIRONI Fabrizio	ITA	WS	66	5	2	73
12	7	RAMON FERRAGUT Jordi	ESP	WS	60	5	5	70
13	19	BOUGUERRA Aymen	TUN	WS	58	3	6	67
14	7	SEDLACEK Marko	CRO	WS	42	12	5	59
15	6	RUIZ MIRA Borja	ESP	MB	38	14	5	57
15	23	CHAKAS Spyridon	GRE	WS	49	3	5	57
15	8	GOKGOZ Gokhan	TUR	WS	44	7	6	57
18	23	OMAR Ahmed	EGY	WS	41	6	7	54
18	2	KADHI Ahmed	TUN	MB	43	11		54
20	7	PANOU Joachim	FRA	WS	45	3	5	53
21	14	MAGALINI Giulio	ITA	WS	44	3	3	50
22	18	BONGUI Ali	TUN	OS	43	3	3	49
23	8	IKKEN Boudjemaa	ALG	OS	39	6	3	48
24	17	MIHALJ Ivan	CRO	MB	25	21	1	47
25	1	IRIBARNE FERNANDEZ Francisco Javier	ESP	WS	36	8	2	46
26	4	NIKACEVIC Kruno	CRO	MB	28	13	4	45
27	8	EISSA Abdelrahman	EGY	WS	38	3	3	44
27	12	DIEDHIOU DIATTA Jean Pascal	ESP	MB	28	13	3	44
27	13	TOSUN Burakhan	TUR	MB	24	17	3	44
30	7	PETREAS Georgios	GRE	MB	23	13	6	42
30	9	AGREBI Omar	TUN	MB	18	21	3	42
32	6	BEN OTHMEN MILADI Mohamed Ali	TUN	WS	33	4	4	41
33	17	ULU Dogukan	TUR	MB	20	17	2	39
34	9	HACIOGLU Mehmet	TUR	WS	33	4	1	38
35	10	MASOUD Mohamed	EGY	MB	23	13	1	37
35	13	KHATER Mohamed	EGY	MB	29	4	4	37
35	15	RAPTIS Alexandros	GRE	WS	32	2	3	37
35	25	VITELLI Marco	ITA	MB	29	2	6	37
39	13	GUEYE Mousse	FRA	MB	19	15	2	36
39	8	TZIOUMAKAS Georgios	GRE	OS	33	3		36
<b>Tournament Totals</b>					2522	466	3225	237



## Top Player Ranking by Skill

As of MON 4 JUL 2022 at 22:19

### Best Spikes

Scoring Spikes	Rk	No.	Name	CTRY	Pos.	Spikes	Faults	Shots	Total Attempts	Eff.%
	1	25	VITELLI Marco	ITA	MB	29	4	6	39	64.10
	2	4	NIKACEVIC Kruno	CRO	MB	28	3	9	40	62.50
	3	13	KHATER Mohamed	EGY	MB	29	4	8	41	60.98
	4	2	KADHI Ahmed	TUN	MB	43	5	15	63	60.32
	5	12	DIEDHIOU DIATTA Jean Pascal	ESP	MB	28	7	6	41	51.22
	6	6	RUIZ MIRA Borja	ESP	MB	38	9	10	57	50.88
	7	11	HOSNI Soufiane	ALG	WS	25	4	13	42	50.00
	7	17	MIHALJ Ivan	CRO	MB	25	3	16	44	50.00
	9	3	RECINE Francesco	ITA	WS	66	11	44	121	45.45
Limit 15.00%	<b>Tournament Totals</b>					2522	861	1846	5229	31.77

### BEST BLOCKERS

Scoring Block	Rk	No.	Name	NOC	Pos.	Kill Blocks	Faults	Rebounds	Total Attempts	Avg by Set
	1	9	AGREBI Omar	TUN	MB	21	29	20	70	1.00
	2	17	MIHALJ Ivan	CRO	MB	21	34	23	78	0.95
	3	7	SEDLACEK Marko	CRO	WS	12	6	4	22	0.92
	4	17	ULU Dogukan	TUR	MB	17	22	21	60	0.89
	5	13	TOSUN Burakhan	TUR	MB	17	23	27	67	0.77
	6	2	BOUYOUCEF Sofiane	ALG	MB	6	14	9	29	0.75
	6	13	GUEYE Mousse	FRA	MB	15	22	15	52	0.75
	8	10	MASOUD Mohamed	EGY	MB	13	22	13	48	0.72
	9	4	NIKACEVIC Kruno	CRO	MB	13	26	24	63	0.68
	10	8	IKKEN Boudjemaa	ALG	OS	6	8	7	21	0.67
	<b>Tournament Totals</b>					466	1060	744	2270	0.21

### Best Servers

Scoring Service	Rk	No.	Name	CTRY	Pos.	Aces	Faults	Serve Hits	Total Attempts	Avg. by Set
	1	15	TOY Metin	TUR	OS	12	14	55	81	0.55
	2	10	NIKOLIC Dusan	SRB	WS	3	5	14	22	0.43
	3	18	SHFIK Ahmed	EGY	WS	8	10	60	78	0.42
	4	23	OMAR Ahmed	EGY	WS	7	12	38	57	0.41
	4	3	RECINE Francesco	ITA	WS	7	12	49	68	0.41
	6	15	ROEHRIG Simon	FRA	MB	4	4	13	21	0.40
	7	7	SEDLACEK Marko	CRO	WS	5	11	36	52	0.38
	7	10	SESTAN Filip	CRO	WS	8	20	68	96	0.38
	9	25	VITELLI Marco	ITA	MB	6	12	54	72	0.35
	9	10	FALASCHI Marco	ITA	S	6	8	65	79	0.35
	<b>Tournament Totals</b>					237	722	4506	3547	0.05



## Top Player Ranking by Skill

As of MON 4 JUL 2022 at 22:19

### BEST DIGGERS

Non-Scoring Dig	Rk	No.	Name	CTRY	Pos.	Digs	Faults	Receptions	Total Attempts	Avg. by Set
	1	20	HMISSI Saddam	TUN	L	19	9	34	62	3.17
	2	2	RAMON Luca	FRA	L	16	13	26	55	2.67
	3	13	PERVAN Hrvoje	CRO	L	9	10	17	36	1.50
	3	6	RICHLIEV Kostadin	MKD	L	3	5	10	18	1.50
	3	19	BAYRAKTAR Berkay	TUR	L	9	16	23	48	1.50
	6	1	CHANDRINOS Aristeidis	GRE	L	6	14	25	45	1.20
	7	23	CATANIA Damiano	ITA	L	5	8	29	42	1.00
	7	19	NEGIC Stefan	SRB	L	3	18	12	33	1.00
	9	8	LARRANAGA LEDO Unai	ESP	L	4	8	30	42	0.67
	9	21	SCHIRO Andrea	ITA	OS	2			2	0.67
<b>Tournament Totals</b>						198	519	925	1642	0.12

### Best Setters

Non-Scoring Set	Rk	No.	Name	CTRY	Pos.	Running Sets	Faults	Still Sets	Total Attempts	Avg. by Set	
	No data available for Best Setters.										
	<b>Tournament Totals</b>							72		72	0.00

### Best Receivers

Non-Scoring Reception	Rk	No.	Name	CTRY	Pos.	Excellents	Faults	Serve Receptions	Total Attempts	Succ. %
	1	4	NIKACEVIC Kruno	CRO	MB	4		1	5	80.00
	2	17	TIZIT Farouk	ALG	WS	6		4	10	60.00
	2	8	POL Alberto	ITA	WS	3		2	5	60.00
	4	2	RAMON Luca	FRA	L	77	7	47	131	58.78
	5	3	RECINE Francesco	ITA	WS	49	4	37	90	54.44
	6	8	LARRANAGA LEDO Unai	ESP	L	50	5	38	93	53.76
	7	11	HOSNI Soufiane	ALG	WS	30	3	23	56	53.57
	8	9	HACIOGLU Mehmet	TUR	WS	30	5	24	59	50.85
	9	6	HASSAN Mohamed	EGY	L	54	7	48	109	49.54
	10	23	CATANIA Damiano	ITA	L	39	2	38	79	49.37
<b>Tournament Totals</b>						1518	235	1996	3749	40.49

#### LEGEND

<b>Avg</b> Average per Game	<b>Eff%</b> Efficiency	<b>L</b> Libero	<b>MB</b> Middle Blocker
<b>NO.</b> Shirt Number	<b>OS</b> Opposite Striker	<b>Pos.</b> Playing Position	<b>S</b> Setter
<b>Succ</b> Success%	<b>WS</b> Wing Sprike	-	-



## Team Ranking by Skill

As of MON 4 JUL 2022 at 22:17

Scoring Spike	Rk	Team	Spikes	Faults	Shots	Total Attempts	Eff. %
	1	ITA - Italy	247	58	156	461	41.00
	2	CRO - Croatia	283	76	217	576	35.94
	3	ESP - Spain	309	109	158	576	34.72
	4	FRA - France	309	99	220	628	33.44
	5	EGY - Egypt	233	78	157	468	33.12
	6	TUN - Tunisia	300	100	213	613	32.63
	7	ALG - Algeria	102	34	95	231	29.44
	8	GRE - Greece	295	110	263	668	27.69
	9	MKD - North Macedonia	73	28	65	166	27.11
	10	SRB - Serbia	129	62	85	276	24.28
	11	TUR - Turkiye	242	107	217	566	23.85
<b>Tournament Totals</b>			2522	861	1846	5229	31.77

Scoring Block	Rk	Team	Kill Blocks	Faults	Rebounds	Total Attempts	Avg. by Set
	1	CRO - Croatia	83	135	97	315	3.77
	2	ALG - Algeria	25	52	28	105	2.78
	3	TUR - Turkiye	58	116	106	280	2.64
	4	TUN - Tunisia	55	137	73	265	2.39
	5	ESP - Spain	54	126	82	262	2.35
	6	FRA - France	51	99	89	239	2.32
	7	GRE - Greece	45	119	96	260	1.88
	8	EGY - Egypt	35	111	60	206	1.84
	9	ITA - Italy	31	75	77	183	1.82
	10	SRB - Serbia	19	57	25	101	1.73
	11	MKD - North Macedonia	10	33	11	54	1.67
<b>Tournament Totals</b>			466	1060	744	2270	0.21

Scoring Service	Rk	Team	Aces	Faults	Serve Hits	Total Attempts	Avg. by Set
	1	ITA - Italy	26	73	318	417	1.53
	2	TUN - Tunisia	32	99	393	524	1.39
	3	EGY - Egypt	25	60	331	416	1.32
	3	TUR - Turkiye	29	61	375	465	1.32
	5	GRE - Greece	31	77	419	527	1.29
	6	CRO - Croatia	26	74	438	538	1.18
	7	FRA - France	25	102	393	520	1.14
	8	SRB - Serbia	12	42	184	238	1.09
	9	ESP - Spain	21	90	425	536	0.91
	10	ALG - Algeria	7	23	168	198	0.78
	11	MKD - North Macedonia	3	21	103	127	0.50
<b>Tournament Totals</b>			237	722	3547	4506	0.05



### Team Ranking by Skill

As of MON 4 JUL 2022 at 22:17

Non-Scoring Dig	Rk	Team	Aces	Faults	Serve	Total Attempts	Avg. by Set
	1	TUN - Tunisia	40	45	119	204	1.74
	2	FRA - France	30	58	105	193	1.36
	3	GRE - Greece	28	71	115	214	1.17
	3	MKD - North Macedonia	7	20	32	59	1.17
	5	TUR - Turkiye	24	52	90	166	1.09
	6	CRO - Croatia	19	55	95	169	0.86
	7	ITA - Italy	14	44	100	158	0.82
	8	SRB - Serbia	8	46	38	92	0.73
	9	ALG - Algeria	6	23	34	63	0.67
	10	EGY - Egypt	11	54	80	145	0.58
	11	ESP - Spain	11	51	117	179	0.48
<b>Tournament Totals</b>			198	519	925	1642	0.12

Non-Scoring Set	Rk	Team	Running Sets	Faults	Still Sets	Total Attempts	Avg. by Set
	1	ALG - Algeria		3		3	0.00
	1	CRO - Croatia		7		7	0.00
	1	EGY - Egypt		15		15	0.00
	1	ESP - Spain		6		6	0.00
	1	FRA - France		4		4	0.00
	1	GRE - Greece		14		14	0.00
	1	ITA - Italy		4		4	0.00
	1	MKD - North Macedonia		2		2	0.00
	1	SRB - Serbia		4		4	0.00
	1	TUN - Tunisia		7		7	0.00
	1	TUR - Turkiye		6		6	0.00
<b>Tournament Totals</b>				72		72	0.00

Non-Scoring Reception	Rk	Team	Excellents	Faults	Serve Reception	Total Attempts	Succ. %
	1	ALG - Algeria	81	11	80	172	47.09
	2	ITA - Italy	133	15	138	286	46.50
	3	ESP - Spain	186	23	211	420	44.29
	4	TUN - Tunisia	194	28	230	452	42.92
	5	GRE - Greece	196	28	243	467	41.97
	6	FRA - France	168	22	229	419	40.10
	7	EGY - Egypt	147	24	197	368	39.95
	8	SRB - Serbia	82	12	127	221	37.10
	9	TUR - Turkiye	150	32	224	406	36.95
	10	CRO - Croatia	143	25	250	418	34.21
	11	MKD - North Macedonia	38	15	67	120	31.67
<b>Tournament Totals</b>			1518	235	1996	3749	40.49

**LEGEND**

Avg. Average

Eff. % Efficiency

Rk Rank

Succ. Success %



## Medallists

As of MON 4 JUL 2022 at 22:19

Gold	Silver	Bronze
<b>ITA - Italy</b>	<b>TUR - Turkiye</b>	<b>SRB - Serbia</b>
2 BOSIO Francesca	1 YILMAZ Melis	1 TAUBNER Tara
13 BATTISTONI Ilaria	2 AYDIN Ilkin	2 TISMA Andrea
16 D'ODORICO Sofia	3 ARICI Emine	3 OSMAJIC Minja
19 SQUARCINI Federica	5 AKYALDIZ Ezgi	4 GOCANIN Bojana
20 PANETONI Sara	8 UNAL Buse	10 CVETKOVIC Jovana
22 ENWEONWU Nkemdiim Terry	9 KILIC Aslihan	11 KURTAGIC Hena
23 PERINELLI Elena	10 AKYOL Aycin	12 MALESEVIC Ana
24 MAZZARO Alessia	11 KAYACAN SONSIRMA Buse	14 SAVIC Vanja
27 CAGNIN Emma	17 YUZGENC Tutku Burcu	15 KOCKAREVIC Isidora
28 DIOP Bintou	18 YILDIRIM Yasemin	18 TICA Branka
29 FROSINI Giorgia	19 CEBECIOGLU Derya	21 IVANOVIC Vanja
36 NWAKALOR Linda Nkiruka	20 ERKEK Yaprak	30 PEROVIC Rada





## Final Standings

As of SUN 26 JUN 2022 at 22:15

P4

Medal	Rank	Team
Gold	1	ITA - Italy
Silver	2	TUR - Turkiye
Bronze	3	SRB - Serbia
	4	ESP - Spain
	5	GRE - Greece
	6	EGY - Egypt
	7	CRO - Croatia
	8	TUN - Tunisia
	9	FRA - France
	10	ALG - Algeria
	10	MKD - North Macedonia



## Team Roster

As of SAT 25 JUN 2022 at 23:16

### ALG - Algeria

No.	Name	Shirt Name	Pos.	Height m / ft	Weight kg / lb	Date of Birth	Club
1	OUDAI Zina Mordjane		S	1.80 / 5' 11"	66/146	19 JUL 2000	
3	HAMMOUCHE Salima		L	1.85 / 6' 1"	75/165	17 JAN 1984	
5	BRAHMI Fahima		MB	1.85 / 6' 1"	75/165	2 MAR 1993	
6	DJOUHRI Wissem		OS	1.85 / 6' 1"	75/165	21 FEB 2002	
7	BECHAR Amira		WS	1.80 / 5' 11"	60/132	11 FEB 2002	
8	BENSALEM Zohra (C)		WS	1.80 / 5' 11"	65/143	5 APR 1990	
10	SOUALMI Melissa		OS	1.85 / 6' 1"	75/165	15 OCT 2002	
11	ABDERRAHIM Yasmine		WS	1.80 / 5' 11"	60/132	16 APR 1999	
12	DJOUHRI Kahina		MB	1.85 / 6' 1"	75/165	27 MAY 2000	
13	BELLAHSENE Radia Nadra	BELLAHSENE	S	1.85 / 6' 1"	75/165	28 JAN 1994	
14	RABAH-MAZARI Bekhta		WS	1.85 / 6' 1"	75/165	5 MAY 1998	
15	MEZEMATE Aicha		MB	0.85 / 2' 9"	75/165	6 JUN 1991	
		<b>Team Minimum</b>		0.85 / 2' 9"	60/132		
		<b>Team Average</b>		1.75 / 2' 9"	71/132		
		<b>Team Maximum</b>		1.85 / 2' 9"	75/132		

#### Technical Staff:

Team Assistant Coach	MOHAMED BENATTIA Belkacem
Team Assistant Coach	KHAMTACHE Amal
Physiotherapist	BENSAYAH Sirine Ikram

#### LEGEND

(C)	Team Captain	BH	Both Handed	Han.	Handedness	L	Libero
LH	Left Handed	MB	Middle Blocker	No.	Shirt Number	OS	Opposite Spiker
Pos	Playing Position	RH	Right Handed	S	Setter	WS	Wing Spiker



## Team Roster

As of SAT 25 JUN 2022 at 23:16

### CRO - Croatia

No.	Name	Shirt Name	Pos.	Height m / ft	Weight kg / lb	Date of Birth	Club
2	GRBAVICA Mika	Grbavica	OS	1.91 / 6' 3"	75/165	8 DEC 2001	HAOK Mladost, Zagreb
4	BUTIGAN Bozana	Butigan	MB	1.92 / 6' 4"	78/172	19 AUG 2000	Volley Bergamo, Bergamo (ITA)
5	BOZICEVIC Nikolina	Božicevic	L	1.65 / 5' 5"	54/119	14 JAN 1995	CSM Targoviste, Targoviste (ROU)
6	PERIC Klara	Peric	S	1.85 / 6' 1"	70/154	30 MAR 1998	HAOK Mladost, Zagreb (CRO)
7	MILOS Laura	Miloš	WS	1.78 / 5' 10"	64/141	20 OCT 1994	Saint Raphael, Saint Raphael (FRA)
8	POPIC Astrid	Popic	MB	1.90 / 6' 3"	76/168	24 JUL 1998	HAOK Mladost, Zagreb (CRO)
11	DUMANCIC Beta	Dumancic	MB	1.90 / 6' 3"	80/176	26 MAR 1991	RR Vilsbiburg, Vilsbiburg (GER)
12	MARKOVIC Josipa	Markovic	WS	1.85 / 6' 1"	70/154	25 JAN 2001	HAOK Mladost, Zagreb (CRO)
14	SAMADAN Martina (C)	Šamadan	MB	1.93 / 6' 4"	82/181	11 SEP 1994	HAOK Mladost, Zagreb (CRO)
16	DEAK Lea	Deak	S	1.77 / 5' 10"	68/150	27 APR 2000	Volero Zurich, Zurich (SUI)
19	STIMAC Izabela	Štimac	L	1.71 / 5' 7"	65/143	12 NOV 2000	HAOK Mladost, Zagreb (CRO)
20	TOMIC Natalia	Tomic	WS	1.88 / 6' 2"	68/150	4 JAN 2002	HAOK Mladost, Zagreb (CRO)
<b>Team Minimum</b>				1.65 / 5' 10"	54/119		
<b>Team Average</b>				1.84 / 5' 10"	71/119		
<b>Team Maximum</b>				1.93 / 5' 10"	82/119		

Uniform Colours	Shirt	Shorts
Main	Red	Blue
2nd	White	Blue
3rd	Blue	Blue

#### Technical Staff:

Team Assistant Coach	MATELA Piotr Jerzy
Team Assistant Coach	MICHALSKI Krzysztof
Physiotherapist	ZUCCA Francesco

#### LEGEND

(C)	Team Captain	BH	Both Handed	Han.	Handedness	L	Libero
LH	Left Handed	MB	Middle Blocker	No.	Shirt Number	OS	Opposite Spiker
Pos	Playing Position	RH	Right Handed	S	Setter	WS	Wing Spiker



## Team Roster

As of SAT 25 JUN 2022 at 23:16

EGY - Egypt

No.	Name	Shirt Name	Pos.	Height m / ft	Weight kg / lb	Date of Birth	Club
1	ELSHAMY Aya		OS	1.83 / 6' 0"	85/187	27 NOV 1995	
4	MEAWAD Nada		WS	1.80 / 5' 11"	71/157	12 APR 1998	
7	AHMED Mariam		L	1.69 / 5' 7"	60/132	5 SEP 1995	
8	ABDELFATTAH Nahla		WS	1.74 / 5' 9"	74/163	21 JAN 1990	
10	AHMED Maya		OS	1.80 / 5' 11"	69/152	8 MAR 1998	
11	HANAFY Sarah	HANAFY	OS	1.79 / 5' 10"	80/176	15 APR 1997	
12	ELASKALANY Farida		MB	1.84 / 6' 0"	81/179	14 FEB 1995	
13	MAHFOUZ Laila		S	1.62 / 5' 4"	60/132	27 JUL 1994	
15	ELELEMY Zeina		WS	1.81 / 5' 11"	75/165	1 JAN 2000	
19	SAYID Sohila		S	1.74 / 5' 9"	72/159	26 AUG 2000	
20	MORSY Mariam		MB	1.87 / 6' 2"	83/183	2 JAN 1999	
22	MORSHEDY Dalia		MB	1.82 / 6' 0"	80/176	15 NOV 2001	
		<b>Team Minimum</b>		1.62 / 5' 10"	60/132		
		<b>Team Average</b>		1.78 / 5' 10"	74/132		
		<b>Team Maximum</b>		1.87 / 5' 10"	85/132		

### Technical Staff:

Coach MOHAMED Ahmed

### LEGEND

(C)	Team Captain	BH	Both Handed	Han.	Handedness	L	Libero
LH	Left Handed	MB	Middle Blocker	No.	Shirt Number	OS	Opposite Spiker
Pos	Playing Position	RH	Right Handed	S	Setter	WS	Wing Spiker



## Team Roster

As of SAT 25 JUN 2022 at 23:16

ESP - Spain

No.	Name	Shirt Name	Pos.	Height m / ft	Weight kg / lb	Date of Birth	Club
5	VILLASANTE COSTA Laura		OS			3 JAN 1992	
6	RODRIGUEZ VILLANUEVA Elia	RODRIGUEZ	S	1.79 / 5' 10"	63/139	19 MAY 2003	DSV SANT CUGAT, SAN CUGAT DEL
7	PIZA HOMAR Margalida Victoria	PIZÀ	L	1.60 / 5' 3"	65/143	27 MAY 2000	FEEL VOLEY ALCOBENDAS, ALCOBE
8	GARCIA CONRADO Carlota	GARCIA	MB	1.89 / 6' 2"	70/154	21 FEB 1992	AVARCA DE MENORCA, CIUTADELLA
9	LAZARO CASTELLANOS Raquel	LAZARO	S	1.80 / 5' 11"	67/148	4 JAN 2000	USC TROJANS, LOS ANGELES (USA)
10	CARPINTERO GOMEZ Paula Del Carmen	CARPINTERO	OS	1.80 / 5' 11"	77/170	17 MAY 1999	KIELE, SOCUELLAMOS (ESP)
12	VARELA GOMEZ Lucia	VARELA	MB	1.96 / 6' 5"	85/187	10 AUG 2003	URBASER GRAN CANARIA, LAS PAL
15	PROL BRUNA Lucia (C)	PROL	WS	1.76 / 5' 9"	73/161	30 NOV 1999	HARIS SANAYA LIBBY'S, LA LAGUNA
18	JIMENEZ RUIZ Carla		MB	1.85 / 6' 1"	77/170	14 JUN 2002	
21	VILLA NAVARRO Ines	VILLA	WS			14 FEB 1998	CV LEGANES, LEGANES (ESP)
22	LLORENS FERNANDEZ Cristina Covadonga	LLORENS	WS			6 MAR 1995	AVARCA DE MENORCA, CIUTADELLA
24	BRAVO CULEBRAS Denia	BRAVO	WS	1.80 / 5' 11"	64/141	14 APR 1998	FEEL VOLEY ALCOBENDAS, ALCOBE

Team Minimum

Team Average

Team Maximum

1.81 / 0

71/0

1.96 / 0

85/0

Uniform Colours    Shirt    Shorts

Main                    Red    Blue

2nd                      Yellow    Red

### Technical Staff:

Team Assistant Coach	GARCIA DIAZ Juan Diego
Team Assistant Coach	SALLERAS GRAND Jose Pablo
Team Doctor	IBANEZ MARTIN Luisa Ignacia
Physiotherapist	GUTIERREZ PEREZ Marta

### LEGEND

(C)	Team Captain	BH	Both Handed	Han.	Handedness	L	Libero
LH	Left Handed	MB	Middle Blocker	No.	Shirt Number	OS	Opposite Spiker
Pos	Playing Position	RH	Right Handed	S	Setter	WS	Wing Spiker



## Team Roster

As of SAT 25 JUN 2022 at 23:16

### FRA - France

No.	Name	Shirt Name	Pos.	Height m / ft	Weight kg / lb	Date of Birth	Club
8	BERNARD Manon	GELIN	L	1.74 / 5' 9"	63/139	23 JAN 1995	RC CANNES, Cannes (FRA)
13	MOBISA Aurore	MOBISA	MB	1.84 / 6' 0"	68/150	3 DEC 2002	VITROLLES SPORTS VB, Vitrolles (FR)
21	ELOUGA Eva	ELOUGA	WS	1.91 / 6' 3"	79/174	14 OCT 1999	AS Saint Raphael VVB, Saint Raphael (
23	OLINGA ANDELA Leandra (C)	OLINGA ANDELA	MB	1.85 / 6' 1"	84/185	12 AUG 1997	ASPTT MULHOUSE, Mullhouse (FRA)
27	MAURIAT Mahe	MAURIAT	S	1.73 / 5' 8"	61/134	23 MAY 2000	BEZIERS ANGELS, Béziers (FRA)
34	ARBOS Lisa	ARBOS	WS	1.81 / 5' 11"	69/152	22 NOV 1996	AS Saint Raphael VVB, Saint Raphael (
38	RATAHIRY Leia	RATAHIRY	WS	1.78 / 5' 10"	62/137	27 SEP 2002	GRENOBLE V. UNIVERSITE, Grenoble
63	RESPAUT Emilie	RESPAUT	S	1.76 / 5' 9"	56/123	25 APR 2003	VOLERO LE CANNET, Le Cannet (FRA)
75	DIOUF Guewe	DIOUF	WS	1.81 / 5' 11"	70/154	15 JUN 2002	ASPTT MULHOUSE, Mullhouse (FRA)
78	DIA Aminata	DIA	MB	1.85 / 6' 1"	68/150	21 FEB 2002	TERVILLE FLORANGE OLYMPIQUE, T
91	BAH Halimatou	BAH	WS	1.85 / 6' 1"	70/154	21 DEC 2003	AS VB DU VAL D'HYERRES, Yerres (F
98	HAEWEGENE Sabine	HAEWEGENE	WS	1.79 / 5' 10"	62/137	9 MAY 1995	EVREUX VOLLEY BALL, Evreux (FRA)
<b>Team Minimum</b>				1.73 / 5' 10"	56/123		
<b>Team Average</b>				1.81 / 5' 10"	68/123		
<b>Team Maximum</b>				1.91 / 5' 10"	84/123		

Uniform Colours	Shirt	Shorts
Main	Blue	Blue
2nd	White	Red
3rd	Red	Red

#### Technical Staff:

Team Assistant Coach	LE DRAOULEC Gael
Team Assistant Coach	FOUCHET Emmanuel
Physiotherapist	BALAGUER Herve

#### LEGEND

(C)	Team Captain	BH	Both Handed	Han.	Handedness	L	Libero
LH	Left Handed	MB	Middle Blocker	No.	Shirt Number	OS	Opposite Spiker
Pos	Playing Position	RH	Right Handed	S	Setter	WS	Wing Spiker



## Team Roster

As of SAT 25 JUN 2022 at 23:16

### GRE - Greece

No.	Name	Shirt Name	Pos.	Height m / ft	Weight kg / lb	Date of Birth	Club
1	CHATZIEFSTRATIADOU Eirini	CHATZIEFSTRATI	MB	1.85 / 6' 1"	78/172	2 SEP 1995	PAO, Athens (GRE)
4	KONSTANTINIDOU Lamprini	KONSTANTINIDO	S	1.86 / 6' 1"	81/179	16 SEP 1996	AO THIRAS, Santorini (GRE)
5	NIKOLOGIANNI Asimina	NIKOLOGIANNI	WS	1.83 / 6' 0"	73/161	4 JUN 1999	PANNAXIAKOS, NAXOS (GRE)
8	ILIOPOULOU Elisavet	ILIOPOULOU	S	1.77 / 5' 10"	59/130	25 JAN 2001	PAOK, Thessaloniki (GRE)
9	STRANTZALI Olga (C)	STRANTZALI	WS	1.85 / 6' 1"	70/154	12 JAN 1996	ALBA BLAJ, BLAJ (ROU)
13	XANTHOPOULOU Maria Aikaterini	XANTHOPOULOU	L	1.63 / 5' 4"	65/143	24 OCT 1998	PAOK, Thessaloniki (GRE)
16	GENITSARIDI Maria		OS	1.86 / 6' 1"	87/192	3 JUN 1994	
19	SPANOU Anna Maria	SPANOU	WS	1.87 / 6' 2"	79/174	18 NOV 1995	TERVILLE, TERVILLE (FRA)
21	KYPARISSI Stamatia	KYPARISSI	WS	1.85 / 6' 1"	70/154	20 JUN 2002	PAOK, Thessaloniki (GRE)
22	KLEPKOU Maria	KLEPKOU	WS	1.78 / 5' 10"	58/128	13 MAY 2000	PAOK, Thessaloniki (GRE)
23	TERZOGLOU Kyriaki	TERZOGLOU	MB	1.87 / 6' 2"	70/154	22 NOV 2003	PAOK, Thessaloniki (GRE)
24	TSIOGKA Andromachi		MB	1.90 / 6' 3"	78/172	3 NOV 2001	
		<b>Team Minimum</b>		1.63 / 5' 10"	58/128		
		<b>Team Average</b>		1.83 / 5' 10"	72/128		
		<b>Team Maximum</b>		1.9 / 5' 10"	87/128		

Uniform Colours	Shirt	Shorts
Main	Blue	Blue
2nd	White	White

#### Technical Staff:

Team Assistant Coach	BOUTSOURIS Nikolaos
Team Assistant Coach	ALPI Daniele
Physiotherapist	VLASSOPOULOS Xenofon Filippos

#### LEGEND

(C)	Team Captain	BH	Both Handed	Han.	Handedness	L	Libero
LH	Left Handed	MB	Middle Blocker	No.	Shirt Number	OS	Opposite Spiker
Pos	Playing Position	RH	Right Handed	S	Setter	WS	Wing Spiker



## Team Roster

As of SAT 25 JUN 2022 at 23:16

### ITA - Italy

No.	Name	Shirt Name	Pos.	Height m / ft	Weight kg / lb	Date of Birth	Club
2	BOSIO Francesca		S			8 JUL 1997	
13	BATTISTONI Ilaria	BATTISTONI	S			22 APR 1996	IGOR GORGONZOLA NOVARA, NOVA
16	D'ODORICO Sofia	D'ODORICO	WS			1 JUN 1997	IGOR GORGONZOLA NOVARA, NOVA
19	SQUARCINI Federica	SQUARCINI	MB			24 SEP 2000	BOSCA SAN BERNARDO CUNEO, CU
20	PANETONI Sara	PANETTONI	L			5 JUN 2000	IL BISONTE FIRENZE, FIRENZE (ITA)
22	ENWEONWU Nkemdilim Terry	ENWEONWU	WS			5 DEC 2000	IL BISONTE FIRENZE, FIRENZE (ITA)
23	PERINELLI Elena (C)	PERINELLI	WS			27 JUN 1995	REALE MUTUA FENERA CHIERI 76, C
24	MAZZARO Alessia	MAZZARO	MB			19 SEP 1998	REALE MUTUA FENERA CHIERI 76, C
27	CAGNIN Emma		WS			26 JUN 2002	
28	DIOP Bintou	DIOP	OS			2 MAR 2002	BARTOCCINI FORTINFISSI PERUGIA,
29	FROSINI Giorgia	FROSINI	OS			29 NOV 2002	PROSECCO DOC IMOCO VOLLEY CO
36	NWAKALOR Linda Nkiruka	NWAKALOR	MB			17 SEP 2002	BARTOCCINI FORTINFISSI PERUGIA,

Team Minimum

Team Average

Team Maximum

Uniform Colours	Shirt	Shorts
Main	Blue	Blue
2nd	White	Blue

#### Technical Staff:

Team Assistant Coach	SAJA Stefano
Team Assistant Coach	INGRATTA Matteo
Team Doctor	RASPANTE LA SCALA Ignazio Sergio
Physiotherapist	PEDROLI Marta

#### LEGEND

(C)	Team Captain	BH	Both Handed	Han.	Handedness	L	Libero
LH	Left Handed	MB	Middle Blocker	No.	Shirt Number	OS	Opposite Spiker
Pos	Playing Position	RH	Right Handed	S	Setter	WS	Wing Spiker





## Team Roster

As of SAT 25 JUN 2022 at 23:16

MKD - North Macedonia

No.	Name	Shirt Name	Pos.	Height m / ft	Weight kg / lb	Date of Birth	Club
1	POPJORDANOVSKA Emilija (C)		L	1.70 / 5' 7"	69/152	3 JAN 1993	
2	BOSHKOVSKA Meri		OS	1.80 / 5' 11"	74/163	6 JUN 2005	
3	STOJANOVSKA Simona		MB	1.77 / 5' 10"	63/139	17 MAY 2001	
4	STOKOSKA Iva		MB	1.82 / 6' 0"	79/174	25 APR 2005	
7	STOJANOVA Tamara		WS	1.78 / 5' 10"	66/146	9 JUN 1997	
7	TERZIEVSKA Tea		WS	1.80 / 5' 11"	66/146	31 DEC 1999	
10	JONUZI Erjona		S	1.82 / 6' 0"	74/163	23 FEB 2001	
12	ANTESKA Nadica		L	1.70 / 5' 7"	56/123	12 APR 2004	
13	PAVLOSKA Ana		MB	1.85 / 6' 1"	71/157	26 JUL 1996	
14	DIKOVA Mila		OS	1.82 / 6' 0"	70/154	9 DEC 2003	
16	GJORGIEVSKA Mia		S	1.76 / 5' 9"	73/161	8 JUN 2006	
18	HADJI TOSEVA Dobrina		WS	1.81 / 5' 11"	69/152	18 MAR 2005	
		<b>Team Minimum</b>		1.70 / 5' 10"	56/123		
		<b>Team Average</b>		1.79 / 5' 10"	69/123		
		<b>Team Maximum</b>		1.85 / 5' 10"	79/123		

### Technical Staff:

Team Assistant Coach      PETROVSKI Ljupcho  
Team Assistant Coach      KALENIKOVA Branka

### LEGEND

(C)	Team Captain	BH	Both Handed	Han.	Handedness	L	Libero
LH	Left Handed	MB	Middle Blocker	No.	Shirt Number	OS	Opposite Spiker
Pos	Playing Position	RH	Right Handed	S	Setter	WS	Wing Spiker



## Team Roster

As of SAT 25 JUN 2022 at 23:16

### SRB - Serbia

No.	Name	Shirt Name	Pos.	Height m / ft	Weight kg / lb	Date of Birth	Club
1	TAUBNER Tara	TAUBNER	L	1.82 / 6' 0"	75/165	11 JAN 2002	Crvena Zvezda, Beograd (SRB)
2	TISMA Andrea		S	1.83 / 6' 0"	77/170	15 APR 2003	
3	OSMAJIC Minja	OSMAJIC	MB	1.79 / 5' 10"	70/154	12 FEB 2003	Jedinstvo, Stara Pazova (SRB)
4	GOCANIN Bojana	GOCANIN	L	1.82 / 6' 0"	75/165	25 SEP 2002	TENT, Obrenovac (SRB)
10	CVETKOVIC Jovana	CVETKOVIC	WS	1.68 / 5' 6"	60/132	25 MAR 2002	TENT, Obrenovac (SRB)
11	KURTAGIC Hena	KURTAGIC	MB	1.77 / 5' 10"	71/157	27 AUG 2004	TENT, Obrenovac (SRB)
12	MALESEVIC Ana	MALESEVIC	MB	1.85 / 6' 1"	78/172	30 MAR 2002	TENT, Obrenovac (SRB)
14	SAVIC Vanja	SAVIC	WS	1.81 / 5' 11"	75/165	13 MAY 2002	Volero, Le Cannet (FRA)
15	KOCKAREVIC Isidora	KOCKAREVIC	WS	1.72 / 5' 8"	65/143	12 JAN 2002	Jedinstvo, Stara Pazova (SRB)
18	TICA Branka	TICA	WS	1.79 / 5' 10"	71/157	23 AUG 2003	Jedinstvo, Stara Pazova (SRB)
21	IVANOVIC Vanja		WS	1.85 / 6' 1"	80/176	22 OCT 2004	
30	PEROVIC Rada (C)	PEROVIC	S	1.75 / 5' 9"	68/150	13 APR 2001	Zeleznicar, Lajkovac (SRB)
				<b>Team Minimum</b>	1.68 / 5' 10"	60/132	
				<b>Team Average</b>	1.79 / 5' 10"	72/132	
				<b>Team Maximum</b>	1.85 / 5' 10"	80/132	

Uniform Colours	Shirt	Shorts
Main	Blue	Blue
2nd	Red	Red
3rd	White	Blue

#### Technical Staff:

Team Assistant Coach	JELESIC Milan
Team Assistant Coach	KOVACEVIC Dusan
Team Assistant Coach	PETROVIC Slobodan

#### LEGEND

(C)	Team Captain	BH	Both Handed	Han.	Handedness	L	Libero
LH	Left Handed	MB	Middle Blocker	No.	Shirt Number	OS	Opposite Spiker
Pos	Playing Position	RH	Right Handed	S	Setter	WS	Wing Spiker



## Team Roster

As of SAT 25 JUN 2022 at 23:16

### TUN - Tunisia

No.	Name	Shirt Name	Pos.	Height m / ft	Weight kg / lb	Date of Birth	Club
2	HAMOUDA Mouna		L	1.75 / 5' 9"	68/150	10 JUN 1996	
3	ENGZOU Dhouha			1.80 / 5' 11"	70/154	11 DEC 2003	
4	GALAI Chourouk		MB	1.85 / 6' 1"	68/150	26 SEP 1997	
7	AGREBI Rahma (C)		OS	1.77 / 5' 10"	70/154	2 NOV 1990	
8	OTHMANI Abir		MB	1.80 / 5' 11"	67/148	29 JAN 1991	
10	ISMAIL Eya		OS	1.83 / 6' 0"	59/130	13 MAY 2001	
12	GHIZAOUI Ameni		WS	1.76 / 5' 9"	50/110	30 MAR 2002	
13	BOURAOUI Sirine		WS	1.81 / 5' 11"	73/161	12 OCT 1998	
14	FATNASSI Hiba		S	1.70 / 5' 7"	60/132	1 JUL 2003	
15	KEBAIER EP HMSSI Nihel		S	1.73 / 5' 8"	60/132	8 AUG 1993	
17	JENHANI Sahar		MB	1.70 / 5' 7"	68/150	1 AUG 2005	
20	ABDA Nesrine		OS	1.90 / 6' 3"	80/176	20 JUL 2004	
		<b>Team Minimum</b>		1.70 / 5' 10"	50/110		
		<b>Team Average</b>		1.78 / 5' 10"	66/110		
		<b>Team Maximum</b>		1.9 / 5' 10"	80/110		

#### LEGEND

<b>(C)</b> Team Captain	<b>BH</b> Both Handed	<b>Han.</b> Handedness	<b>L</b> Libero
<b>LH</b> Left Handed	<b>MB</b> Middle Blocker	<b>No.</b> Shirt Number	<b>OS</b> Opposite Spiker
<b>Pos</b> Playing Position	<b>RH</b> Right Handed	<b>S</b> Setter	<b>WS</b> Wing Spiker



## Team Roster

As of SAT 25 JUN 2022 at 23:16

TUR - Turkey

No.	Name	Shirt Name	Pos.	Height m / ft	Weight kg / lb	Date of Birth	Club
1	YILMAZ Melis	YILMAZ	L			28 JUN 1997	
2	AYDIN Ilkin	AYDIN	WS			5 JAN 2000	
3	ARICI Emine		MB			17 JAN 1997	
5	AKYALDIZ Ezgi		WS			25 MAY 1998	
8	UNAL Buse		S			29 JUL 1997	
9	KILIC Aslihan		S			21 APR 1998	
10	AKYOL Aycin		MB			15 JUN 1999	
11	KAYACAN SONSIRMA Buse (C)	KAYACAN SONSI	L			15 JUL 1992	
17	YUZGENC Tutku Burcu		OS			15 JAN 1999	
18	YILDIRIM Yasemin		MB			28 JAN 1995	
19	CEBECIOGLU Derya		WS			24 OCT 2000	
20	ERKEK Yaprak		WS			2 SEP 2001	
		<b>Team Minimum</b>					
		<b>Team Average</b>					
		<b>Team Maximum</b>					

### Technical Staff:

Team Assistant Coach	CANER Atasever
Team Assistant Coach	SIBEL Kahyalioglu
Physiotherapist	YARKIN Gencer

### LEGEND

(C)	Team Captain	BH	Both Handed	Han.	Handedness	L	Libero
LH	Left Handed	MB	Middle Blocker	No.	Shirt Number	OS	Opposite Spiker
Pos	Playing Position	RH	Right Handed	S	Setter	WS	Wing Spiker



## Results Table - Preliminary Round

P4

As of TUE 28 JUN 2022 at 23:32

Group A				Points per Set					Total Points	Match Duration	Spectators
Match	Date	Teams	Sets	1	2	3	4	5			
2	SUN 26 JUN 2022	FRA vs CRO	2 - 3	23 - 25	25 - 19	19 - 25	25 - 21	10 - 15	102 - 105	2h33	100
12	MON 27 JUN 2022	SRB vs FRA	3 - 1	19 - 25	25 - 17	25 - 20	25 - 22		94 - 84	2h3	
22	TUE 28 JUN 2022	CRO vs SRB	2 - 3	25 - 21	20 - 25	25 - 12	22 - 25	11 - 15	103 - 98	2h16	

Group B				Points per Set					Total Points	Match Duration	Spectators
Match	Date	Teams	Sets	1	2	3	4	5			
4	SUN 26 JUN 2022	EGY vs MKD	3 - 1	25 - 20	11 - 25	25 - 19	25 - 23		86 - 87	1h51	
6	SUN 26 JUN 2022	TUN vs GRE	0 - 3	17 - 25	10 - 25	13 - 25			40 - 75	1h15	
14	MON 27 JUN 2022	MKD vs TUN	0 - 3	20 - 25	11 - 25	21 - 25			52 - 75	1h27	150
16	MON 27 JUN 2022	GRE vs EGY	3 - 0	25 - 19	25 - 14	25 - 22			75 - 55	1h41	150
24	TUE 28 JUN 2022	GRE vs MKD	3 - 0	25 - 18	25 - 16	25 - 19			75 - 53	1h22	150
26	TUE 28 JUN 2022	EGY vs TUN	3 - 1	25 - 21	25 - 21	21 - 25	25 - 14		96 - 81	2h3	100

Group C				Points per Set					Total Points	Match Duration	Spectators
Match	Date	Teams	Sets	1	2	3	4	5			
8	SUN 26 JUN 2022	ITA vs ESP	3 - 0	25 - 15	25 - 17	25 - 19			75 - 51	1h15	
10	SUN 26 JUN 2022	ALG vs TUR	0 - 3	16 - 25	4 - 25	13 - 25			33 - 75	1h8	
18	MON 27 JUN 2022	TUR vs ITA	3 - 1	26 - 24	25 - 19	19 - 25	25 - 21		95 - 89	1h58	300
20	MON 27 JUN 2022	ESP vs ALG	3 - 0	25 - 23	29 - 27	25 - 18			79 - 68	1h32	1000
28	TUE 28 JUN 2022	TUR vs ESP	3 - 1	22 - 25	25 - 16	25 - 18	25 - 18		97 - 77	1h59	300
30	TUE 28 JUN 2022	ITA vs ALG	3 - 0	25 - 11	25 - 14	25 - 18			75 - 43	1h19	1000

Statistics of	Average match duration	Average spectators	Total spectators
Preliminary	1h43	217	3250

Group A																	
Rank	Team	Matches			Ranking Points	Results Details						Sets			Points		
		Played	Won	Lost		3-0	3-1	3-2	2-3	1-3	0-3	Won	Lost	Ratio	Won	Lost	Ratio
1	SRB	2	2	0	5		1	1				6	3	2.000	192	187	1.027
2	CRO	2	1	1	3			1	1			5	5	1.000	208	200	1.040
3	FRA	2	0	2	1				1	1		3	6	0.500	186	199	0.935

Group B																	
Rank	Team	Matches			Ranking Points	Results Details						Sets			Points		
		Played	Won	Lost		3-0	3-1	3-2	2-3	1-3	0-3	Won	Lost	Ratio	Won	Lost	Ratio
1	GRE	3	3	0	9	3						9	0	MAX	225	148	1.520
2	EGY	3	2	1	6		2				1	6	5	1.200	237	243	0.975
3	TUN	3	1	2	3	1				1	1	4	6	0.667	196	223	0.879
4	MKD	3	0	3	0					1	2	1	9	0.111	192	236	0.814

Group C																	
Rank	Team	Matches			Ranking Points	Results Details						Sets			Points		
		Played	Won	Lost		3-0	3-1	3-2	2-3	1-3	0-3	Won	Lost	Ratio	Won	Lost	Ratio
1	TUR	3	3	0	9	1	2					9	2	4.500	267	199	1.342
2	ITA	3	2	1	6	2				1		7	3	2.333	239	189	1.265
3	ESP	3	1	2	3	1				1	1	4	6	0.667	207	240	0.863
4	ALG	3	0	3	0						3	0	9	0.000	144	229	0.629

LEGEND

MAX Ratio with no points or sets lost      Ratio Ratio of points or sets won/lost



SUN 26 JUN 2022  
Start Time 9:30 - End Time 12:03  
Match Duration 2h33  
Spectators 100

**Results**  
**P2**

**FRA vs CRO**  
**2 3**

Team	Sets	1	2	3	4	5	Total
FRA	2	23	25	19	25	10	102
CRO	3	25	19	25	21	15	105
	<b>Playing Time</b>	30min	27min	35min	31min	18min	2h21

First Referee: VERRASCINA A. (ITA)

Second Referee: Nacer ZEBAR (ALG)

FRA - France								
No.	Name	Pos.	1	2	3	4	5	Pts
8	BERNARD Manon	L	L	L	L	L	L	
13	MOBISA Aurore	MB						
21	ELOUGA Eva	WS	6	6	6	1	1	6
23	OLINGA ANDELA Leandra (C)	MB	3	3	3	4	4	9
27	MAURIAT Mahe	S	1	1	1	2	2	2
34	ARBOS Lisa	WS	75	4	4	5	5	12
38	RATAHIRY Leia	WS	5	5	5	6	6	13
63	RESPAUT Emilie	S						
75	DIOUF Guewe	WS	4		34			2
78	DIA Aminata	MB						
91	BAH Halimatou	WS			38		38	1
98	HAEWEGENE Sabine	WS	2	2	2	3	3	25

CRO - Croatia								
No.	Name	Pos.	1	2	3	4	5	Pts
2	GRBAVICA Mika	OS	6	6	6	6	2	19
4	BUTIGAN Bozana	MB	2	2	2	2	1	18
5	BOZICEVIC Nikolina	WS			7	7		
6	PERIC Klara	S						
7	MILOS Laura	WS	4	4	4	4	6	14
8	POPIC Astrid	MB						
11	DUMANCIC Beta	MB						
12	MARKOVIC Josipa	WS	1	1	1	1	3	11
14	SAMADAN Martina (C)	MB	5	5	5	5	4	14
16	DEAK Lea	S	3	3	3	3	5	4
19	STIMAC Izabela	L	L	L	L	L	L	
20	TOMIC Natalia	WS		2		2		

**Coach** ROUSSEAUX Emile  
**Assistant Coach** LE DRAOULEC Gael / FOUCHET

**Coach** AKBAS Ferhat  
**Assistant Coach** MATELA Piotr Jerzy / MICHALSKI Krzysztof

**TEAM AND PLAYER PERFORMANCES**

Won	Total Atts	No.	Name	Scoring Skills	Won	Total Atts	No.	Name
52	148	Total	Team	Spike	63	159	Total	Team
22	55	98	HAEWEGENE Sabine		19	46	2	GRBAVICA Mika
11	29	38	RATAHIRY Leia		11	41	7	MILOS Laura
10	28	34	ARBOS Lisa		11	16	14	SAMADAN Martina
9	52	Total	Team	Block	11	59	Total	Team
6	18	23	OLINGA ANDELA Leandra		6	17	4	BUTIGAN Bozana
1	10	21	ELOUGA Eva		2	8	7	MILOS Laura
1	7	38	RATAHIRY Leia		2	14	14	SAMADAN Martina
9	102	Total	Team	Serve	6	105	Total	Team
3	20	98	HAEWEGENE Sabine		2	26	4	BUTIGAN Bozana
2	20	27	MAURIAT Mahe		1	20	12	MARKOVIC Josipa
1	17	21	ELOUGA Eva		1	10	7	MILOS Laura
69		Total	Team	Opp. Error	64		Total	Team
139	302	Total	Team	Total	144	323	Total	Team

25	80	98	HAEWEGENE Sabine	<b>Best Scorer</b>	19	61	2	GRBAVICA Mika
----	----	----	------------------	--------------------	----	----	---	---------------

**LEGEND**

(C) Team Captain      n Starting line-up where n= starting pos      L Substitute Libero      nn Substitute where nn = shirt number  
Atts Attempts      L Libero      MB Middle Blocker      No. Shirt Number  
Opp. Opponent      OS Opposite Spiker      Pos Playing Position      Pts Points scored  
S Setter      WS Wing Spiker



MON 27 JUN 2022  
Start Time 9:01 - End Time 11:05  
Match Duration 2h3

## Results

### P2

## SRB vs FRA

### 3 1

Team	Sets	1	2	3	4	Total
SRB	3	19	25	25	25	94
FRA	1	25	17	20	22	84
	Playing Time	26min	28min	28min	30min	1h54

First Referee: Eirini MOULA (GRE)

Second Referee: EYIKE M. (CMR)

SRB - Serbia								
No.	Name	Pos.	1	2	3	4	5	Pts
1	TAUBNER Tara	L	L	L	L	L		9
2	TISMA Andrea	S	L			L		
3	OSMAJIC Minja	MB	4	3	2	3		13
4	GOCANIN Bojana	L	L	L	L	L		
10	CVETKOVIC Jovana	WS	15					1
11	KURTAGIC Hena	MB	1	6	5	6		7
12	MALESEVIC Ana	MB					11	2
14	SAVIC Vanja	WS	30				30	4
15	KOCKAREVIC Isidora	WS	6	5	4	5		14
18	TICA Branka	WS	3	2	1	2		19
21	IVANOVIC Vanja	WS						
30	PEROVIC Rada (C)	S	2	1	6	1		3

FRA - France								
No.	Name	Pos.	1	2	3	4	5	Pts
8	BERNARD Manon	L	L	L	L	L		
13	MOBISA Aurore	MB			78			
21	ELOUGA Eva	WS	6	6	6	6		5
23	OLINGA ANDELA Leandra (C)	MB						
27	MAURIAT Mahe	S	1	1	1	1		3
34	ARBOS Lisa	WS		75	4			3
38	RATAHIRY Leia	WS		91	5	91		3
75	DIOUF Guewe	WS	4	4	34	4		14
78	DIA Aminata	MB	3	3	3	3		3
91	BAH Halimatou	WS	5	5	38	5		12
98	HAEWEGENE Sabine	WS	2	2	2	2		17

**Coach** BORICIC Marijana  
**Assistant Coach** JELESIC Milan / KOVACEVIC Dusan /

**Coach** ROUSSEAUX Emile  
**Assistant Coach** LE DRAOULEC Gael / FOUCHET

### TEAM AND PLAYER PERFORMANCES

Won	Total Atts	No. Name	Scoring Skills	Won	Total Atts	No. Name
47	134	Total Team	Spike	47	112	Total Team
17	40	18 TICA Branka		15	34	98 HAEWEGENE Sabine
12	32	15 KOCKAREVIC Isidora		12	23	75 DIOUF Guewe
6	26	1 TAUBNER Tara		9	20	91 BAH Halimatou
8	43	Total Team	Block	9	51	Total Team
4	11	11 KURTAGIC Hena		2	8	91 BAH Halimatou
2	3	14 SAVIC Vanja		2	7	98 HAEWEGENE Sabine
1	7	1 TAUBNER Tara		1	3	75 DIOUF Guewe
17	92	Total Team	Serve	4	86	Total Team
8	28	3 OSMAJIC Minja		1	13	78 DIA Aminata
2	4	12 MALESEVIC Ana		1	14	75 DIOUF Guewe
2	12	30 PEROVIC Rada		1	15	21 ELOUGA Eva
60		Total Team	Opp. Error	57		Total Team
132	269	Total Team	Total	117	249	Total Team

19	54	18 TICA Branka	Best Scorer	17	54	98 HAEWEGENE Sabine
----	----	----------------	-------------	----	----	---------------------

### LEGEND

(C)	Team Captain	n	Starting line-up where n= starting pos	L	Substitute Libero	nn	Substitute where nn = shirt number
Atts	Attempts	L	Libero	MB	Middle Blocker	No.	Shirt Number
Opp.	Opponent	OS	Opposite Spiker	Pos	Playing Position	Pts	Points scored
S	Setter	WS	Wing Spiker				
-	-						



TUE 28 JUN 2022  
Start Time 9:00 - End Time 11:16  
Match Duration 2h16

**Results**  
**P2**

**CRO vs SRB**  
**2 3**

Team	Sets	1	2	3	4	5	Total
CRO	2	25	20	25	22	11	103
SRB	3	21	25	12	25	15	98
	<b>Playing Time</b>	28min	29min	21min	26min	20min	2h4

First Referee: Zied RIDENE (TUN)

Second Referee: Ehsan REJAEYAN (FRA)

CRO - Croatia								
No.	Name	Pos.	1	2	3	4	5	Pts
2	GRBAVICA Mika	OS	3	2	3	3	2	14
4	BUTIGAN Bozana	MB	2	1	2	2	1	19
5	BOZICEVIC Nikolina	L		L			L	
6	PERIC Klara	S						
7	MILOS Laura	WS	1	6	1	1	6	14
8	POPIC Astrid	MB						
11	DUMANCIC Beta	MB					7	1
12	MARKOVIC Josipa	WS	4	3	4	4	3	9
14	SAMADAN Martina (C)	MB	5	4	5	5	4	18
16	DEAK Lea	S	6	5	6	6	5	2
19	STIMAC Izabela	L	L	L	L	L	L	
20	TOMIC Natalia	WS					7	

SRB - Serbia								
No.	Name	Pos.	1	2	3	4	5	Pts
1	TAUBNER Tara	L	L	L	L			8
2	TISMA Andrea	S			14			
3	OSMAJIC Minja	MB	3	5	6	5	5	15
4	GOCANIN Bojana	L	L	L	L	L	L	
10	CVETKOVIC Jovana	WS			15	4	4	2
11	KURTAGIC Hena	MB	6	2	3	2	2	7
12	MALESEVIC Ana	MB				11	11	1
14	SAVIC Vanja	WS			4			1
15	KOCKAREVIC Isidora	WS	5	4	5	1	1	11
18	TICA Branka	WS	2	1	2	3	3	21
21	IVANOVIC Vanja	WS						
30	PEROVIC Rada (C)	S	1	6	1	6	6	7

**Coach** AKBAS Ferhat  
**Assistant Coach** MATELA Piotr Jerzy / MICHALSKI Krzysztof

**Coach** BORICIC Marijana  
**Assistant Coach** JELESIC Milan / KOVACEVIC Dusan /

**TEAM AND PLAYER PERFORMANCES**

Won	Total Atts	No. Name	Scoring Skills	Won	Total Atts	No. Name
58	132	Total Team	Spike	52	129	Total Team
14	27	4 BUTIGAN Bozana		20	50	18 TICA Branka
14	18	14 SAMADAN Martina		8	25	15 KOCKAREVIC Isidora
12	34	2 GRBAVICA Mika	Block	8	12	3 OSMAJIC Minja
13	61	Total Team		13	55	Total Team
5	17	4 BUTIGAN Bozana		5	16	3 OSMAJIC Minja
3	15	14 SAMADAN Martina		3	12	11 KURTAGIC Hena
2	6	7 MILOS Laura	Serve	2	6	15 KOCKAREVIC Isidora
6	103	Total Team		8	97	Total Team
2	19	16 DEAK Lea		3	18	30 PEROVIC Rada
1	18	2 GRBAVICA Mika		2	15	3 OSMAJIC Minja
1	19	12 MARKOVIC Josipa		1	4	12 MALESEVIC Ana
56		Total Team	Opp. Error	66		Total Team
133	296	Total Team	Total	139	281	Total Team

19	61	4 BUTIGAN Bozana	Best Scorer	21	71	18 TICA Branka
----	----	------------------	-------------	----	----	----------------

LEGEND		
(C)	Team Captain	n Starting line-up where n= starting pos
Atts	Attempts	L Libero
Opp.	Opponent	OS Opposite Spiker
S	Setter	WS Wing Spiker
-	-	L Substitute Libero
		MB Middle Blocker
		Pos Playing Position
		nn Substitute where nn = shirt number
		No. Shirt Number
		Pts Points scored





SUN 26 JUN 2022  
Start Time 12:49 - End Time 14:40  
Match Duration 1h51

## Results

P2

### EGY vs MKD

3 1

Team	Sets	1	2	3	4	Total
EGY	3	25	11	25	25	86
MKD	1	20	25	19	23	87
	<b>Playing Time</b>	28min	23min	22min	28min	1h41

First Referee: CORREA BENITEZ (ESP)

Second Referee: Eirini MOULA (GRE)

EGY - Egypt								
No.	Name	Pos.	1	2	3	4	5	Pts
1	ELSHAMY Aya	OS						
4	MEAWAD Nada	WS	6	5	3	2		10
7	AHMED Mariam	L	L	L	L	L		
8	ABDELFAHATTAH Nahla	WS						
10	AHMED Maya	OS	5	4	5	4		13
11	HANAFY Sarah	OS						
12	ELASKALANY Farida (C)	MB	4	6	4	3		16
13	MAHFOUZ Laila	S	19	19				
15	ELELEMY Zeina	WS	3		6	5		11
19	SAYID Sohila	S	2	1	2	1		3
20	MORSY Mariam	MB	1	2	1	6		8
22	MORSHEDEY Dalia	MB	15	3		19		2

MKD - North Macedonia								
No.	Name	Pos.	1	2	3	4	5	Pts
1	POPJORDANOVSKA Emilija (C)	L	L	L	L	L		
2	BOSHKOVSKA Meri	OS						
3	STOJANOVSKA Simona	MB	6	1	6	1		5
4	STOJKOSKA Iva	MB					13	
7	STOJANOVA Tamara	WS	2	3	2	3		14
10	JONUZI Erjona	S	1	2	1	2		11
12	ANTESKA Nadica	L						
13	PAVLOSKA Ana	MB	3	4	3	4		
14	DIKOVA Mila	OS	4	5	4	5		12
16	GJORGIEVSKA Mia	S						
17	TERZIEVSKA Tea	WS	5	6	5	6		19
18	HADJI TOSEVA Dobrina	WS			14	14		

**Coach** MOHAMED Ahmed  
**Assistant Coach**

**Coach** PAUNOVIC Stefan  
**Assistant Coach** PETROVSKI Ljupcho / KALENIKOVA Branka

#### TEAM AND PLAYER PERFORMANCES

Won	Total Atts	No. Name	Scoring Skills	Won	Total Atts	No. Name
50	117	<b>Total Team</b>	<b>Spike</b>	41	106	<b>Total Team</b>
12	21	12 ELASKALANY Farida		14	30	17 TERZIEVSKA Tea
11	24	10 AHMED Maya		13	32	7 STOJANOVA Tamara
11	17	15 ELELEMY Zeina		6	25	14 DIKOVA Mila
8	44	<b>Total Team</b>	<b>Block</b>	10	33	<b>Total Team</b>
4	9	12 ELASKALANY Farida		4	5	17 TERZIEVSKA Tea
2	5	20 MORSY Mariam		2	4	14 DIKOVA Mila
1	5	22 MORSHEDEY Dalia		2	10	3 STOJANOVSKA Simona
5	85	<b>Total Team</b>	<b>Serve</b>	10	88	<b>Total Team</b>
3	20	19 SAYID Sohila		4	19	10 JONUZI Erjona
1	13	4 MEAWAD Nada		4	22	14 DIKOVA Mila
1	17	10 AHMED Maya		1	14	7 STOJANOVA Tamara
47		<b>Total Team</b>	<b>Opp. Error</b>	64		<b>Total Team</b>
110	246	<b>Total Team</b>	<b>Total</b>	125	227	<b>Total Team</b>
16	40	12 ELASKALANY Farida	<b>Best Scorer</b>	19	48	17 TERZIEVSKA Tea

#### LEGEND

(C)	Team Captain	n	Starting line-up where n= starting pos	L	Substitute Libero	nn	Substitute where nn = shirt number
Atts	Attempts	L	Libero	MB	Middle Blocker	No.	Shirt Number
Opp.	Opponent	OS	Opposite Spiker	Pos	Playing Position	Pts	Points scored
S	Setter	WS	Wing Spiker				
-	-						



SUN 26 JUN 2022  
Start Time 15:31 - End Time 16:46  
Match Duration 1h15

## Results

P2

### TUN vs GRE

0 3

Team	Sets	1	2	3	Total
TUN	0	17	10	13	40
GRE	3	25	25	25	75
	Playing Time	24min	21min	24min	1h9

First Referee: Dejan ROGIC (SRB)

Second Referee: Ksenija JURKOVIC (CRO)

TUN - Tunisia								
No.	Name	Pos.	1	2	3	4	5	Pts
2	HAMOUDA Mouna	L	L	L	L			
4	GALAI Chourouk	MB	4	3	4			1
7	AGREBI Rahma (C)	OS	6	5	6			4
8	OTHMANI Abir	MB	1	6	1			
10	ISMAIL Eya	OS	4	7	7			2
12	GHIZAOUI Ameni	WS		13				
13	BOURAOUI Sirine	WS	3	2	3			4
14	FATNASSI Hiba	S	15		15			
15	KEBAIER EP HMSSI Nihel	S	2	1	2			1
17	JENHANI Sahar	MB			4			
20	ABDA Nesrine	OS	5	4	5			11

GRE - Greece								
No.	Name	Pos.	1	2	3	4	5	Pts
1	CHATZIEFSTRATIADOU Eirini	MB	3	4	4			7
4	KONSTANTINIDOU Lamprini	S	1	2	2			7
5	NIKOLOGIANNI Asimina	WS	5	6	6			14
8	ILIOPOULOU Elisavet	S	16					
9	STRANTZALI Olga (C)	WS	2	3	3			12
13	XANTHOPOULOU Maria Aikaterini	L	L	L	L			
16	GENITSARIDI Maria	OS	4	5	5			12
19	SPANOU Anna Maria	WS						
21	KYPARISSI Stamatia	WS	4		9			3
22	KLEPKOU Maria	WS						
23	TERZOGLU Kyriaki	MB	6	1	1			2
24	TSIOGKA Andromachi	MB		1	1			1

**Coach** MESSELMANI Mohamed  
**Assistant Coach** LADJIMI Khaled

**Coach** ABBONDANZA Marcello  
**Assistant Coach** BOUTSOURIS Nikolaos / ALPI Daniele

### TEAM AND PLAYER PERFORMANCES

Won	Total Atts	No. Name	Scoring Skills	Won	Total Atts	No. Name
17	83	Total Team	Spike	47	90	Total Team
8	32	20 ABDA Nesrine		11	18	16 GENITSARIDI Maria
4	22	7 AGREBI Rahma		11	21	5 NIKOLOGIANNI Asimina
3	17	13 BOURAOUI Sirine		10	20	9 STRANTZALI Olga
2	27	Total Team	Block	4	31	Total Team
2	5	20 ABDA Nesrine		2	6	1 CHATZIEFSTRATIADOU Eirini
				1	8	16 GENITSARIDI Maria
				1	3	9 STRANTZALI Olga
4	41	Total Team	Serve	7	74	Total Team
1	7	13 BOURAOUI Sirine		3	11	5 NIKOLOGIANNI Asimina
1	6	15 KEBAIER EP HMSSI Nihel		2	18	4 KONSTANTINIDOU Lamprini
1	7	20 ABDA Nesrine		1	18	9 STRANTZALI Olga
32		Total Team	Opp. Error	50		Total Team
55	151	Total Team	Total	108	195	Total Team
11	44	20 ABDA Nesrine	Best Scorer	14	33	5 NIKOLOGIANNI Asimina

#### LEGEND

(C)	Team Captain	n	Starting line-up where n= starting pos	L	Substitute Libero	nn	Substitute where nn = shirt number
Atts	Attempts	L	Libero	MB	Middle Blocker	No.	Shirt Number
Opp.	Opponent	OS	Opposite Spiker	Pos	Playing Position	Pts	Points scored
S	Setter	WS	Wing Spiker				
-	-						



MON 27 JUN 2022  
Start Time 12:00 - End Time 13:27  
Match Duration 1h27  
Spectators 150

Results  
P2

MKD vs TUN  
0 3

Team	Sets	1	2	3	Total
MKD	0	20	11	21	52
TUN	3	25	25	25	75
	Playing Time	26min	21min	34min	1h21

First Referee: Nacer ZEBAR (ALG)

Second Referee: Dejan ROGIC (SRB)

MKD - North Macedonia								
No.	Name	Pos.	1	2	3	4	5	Pts
1	POPJORDANOVSKA Emilija (C)	L	L	L	L			
2	BOSHKOVSKA Meri	OS		14	17			
3	STOJANOVSKA Simona	MB	6	1	1			5
4	STOJKOSKA Iva	MB	13	3	13			
7	STOJANOVA Tamara	WS	2	3	3			12
10	JONUZI Erjona	S	1	2	2			6
12	ANTESKA Nadica	L						
13	PAVLOSKA Ana	MB	3	4	4			4
14	DIKOVA Mila	OS	4	5	5			3
16	GJORGIEVSKA Mia	S		10				
17	TERZIEVSKA Tea	WS	5	18	6			5
18	HADJI TOSEVA Dobrina	WS	14	6	14			2

TUN - Tunisia								
No.	Name	Pos.	1	2	3	4	5	Pts
2	HAMOUDA Mouna	L	L	L	L			
4	GALAI Chourouk	MB	4	3	4			5
7	AGREBI Rahma (C)	OS	6	5	6			11
8	OTHMANI Abir	MB	1	6	1			6
10	ISMAIL Eya	OS	4		4			
12	GHIZAOUI Ameni	WS			15			
13	BOURAOUI Sirine	WS	3	2	3			10
14	FATNASSI Hiba	S			13			1
15	KEBAIER EP HMSSI Nihel	S	2	1	2			3
17	JENHANI Sahar	MB						
20	ABDA Nesrine	OS	5	4	5			17

**Coach** PAUNOVIC Stefan  
**Assistant Coach** PETROVSKI Ljupcho / KALENIKOVA Branka

**Coach**  
**Assistant Coach**

TEAM AND PLAYER PERFORMANCES

Won	Total Atts	No. Name	Scoring Skills	Won	Total Atts	No. Name
26	107	Total Team	Spike	36	82	Total Team
10	35	7 STOJANOVA Tamara		11	21	20 ABDA Nesrine
5	11	3 STOJANOVSKA Simona		10	20	13 BOURAOUI Sirine
4	26	17 TERZIEVSKA Tea		9	28	7 AGREBI Rahma
4	19	Total Team	Block	12	48	Total Team
2	3	14 DIKOVA Mila		4	17	8 OTHMANI Abir
2	4	13 PAVLOSKA Ana		3	6	4 GALAI Chourouk
				3	6	20 ABDA Nesrine
7	54	Total Team	Serve	5	73	Total Team
2	11	10 JONUZI Erjona		3	17	20 ABDA Nesrine
2	10	7 STOJANOVA Tamara		1	16	15 KEBAIER EP HMSSI Nihel
1	6	18 HADJI TOSEVA Dobrina		1	10	7 AGREBI Rahma
34		Total Team	Opp. Error	41		Total Team
71	180	Total Team	Total	94	203	Total Team
12	46	7 STOJANOVA Tamara	Best Scorer	17	44	20 ABDA Nesrine

LEGEND

(C) Team Captain      n Starting line-up where n= starting pos      L Substitute Libero      nn Substitute where nn = shirt number  
Atts Attempts      L Libero      MB Middle Blocker      No. Shirt Number  
Opp. Opponent      OS Opposite Spiker      Pos Playing Position      Pts Points scored  
S Setter      WS Wing Spiker



MON 27 JUN 2022  
Start Time 15:00 - End Time 16:41  
Match Duration 1h41  
Spectators 150

## Results

P2

**GRE vs EGY**  
**3 0**

Team	Sets	1	2	3	Total
GRE	3	25	25	25	75
EGY	0	19	14	22	55
	<b>Playing Time</b>	29min	33min	33min	1h35

First Referee: Ksenija JURKOVIC (CRO)

Second Referee: CORREA BENITEZ (ESP)

GRE - Greece								
No.	Name	Pos.	1	2	3	4	5	Pts
1	CHATZIEFSTRATIADOU Eirini	MB	3	3	3			3
4	KONSTANTINIDOU Lamprini	S	1	1	1			3
5	NIKOLOGIANNI Asimina	WS	5	5	5			10
8	ILIOPOULOU Elisavet	S						
9	STRANTZALI Olga (C)	WS	2	2	2			14
13	XANTHOPOULOU Maria Aikaterini	L	L	L	L			
16	GENITSARIDI Maria	OS	4	4	4			11
19	SPANOU Anna Maria	WS	5	5	5			3
21	KYPARISSI Stamatia	WS			9			5
22	KLEPKOU Maria	WS						
23	TERZOGLU Kyriaki	MB	6	6	6			6
24	TSIOGKA Andromachi	MB			1			

EGY - Egypt								
No.	Name	Pos.	1	2	3	4	5	Pts
1	ELSHAMY Aya	OS	19	19	4			4
4	MEAWAD Nada	WS	2	3	5			5
7	AHMED Mariam	L	L	L	L			
10	AHMED Maya	OS	4	5	19			5
11	HANAFY Sarah	OS		4				
12	ELASKALANY Farida (C)	MB	3	4	3			4
13	MAHFOUZ Laila	S		10	1			
15	ELELEMY Zeina	WS	5	6	2			9
19	SAYID Sohila	S	1	2	1			3
20	MORSY Mariam	MB	6	1	6			7
22	MORSHEDY Dalia	MB		20				

**Coach** ABBONDANZA Marcello  
**Assistant Coach** BOUTSOURIS Nikolaos / ALPI Daniele

**Coach** MOHAMED Ahmed  
**Assistant Coach**

### TEAM AND PLAYER PERFORMANCES

Won	Total Atts	No. Name	Scoring Skills	Won	Total Atts	No. Name
39	119	Total Team	Spike	27	103	Total Team
9	25	9 STRANTZALI Olga		8	24	15 ELELEMY Zeina
9	35	5 NIKOLOGIANI Asimina		5	21	4 MEAWAD Nada
8	23	16 GENITSARIDI Maria		5	11	20 MORSY Mariam
7	38	Total Team	Block	7	43	Total Team
2	10	1 CHATZIEFSTRATIADOU Eirini		2	7	20 MORSY Mariam
1	3	9 STRANTZALI Olga		1	5	1 ELSHAMY Aya
1	3	5 NIKOLOGIANI Asimina		1	5	19 SAYID Sohila
9	73	Total Team	Serve	3	57	Total Team
4	13	9 STRANTZALI Olga		2	10	19 SAYID Sohila
3	15	16 GENITSARIDI Maria		1	9	10 AHMED Maya
1	4	19 SPANOU Anna Maria				
41		Total Team	Opp. Error	35		Total Team
96	230	Total Team	Total	72	203	Total Team
14	41	9 STRANTZALI Olga	Best Scorer	9	39	15 ELELEMY Zeina

#### LEGEND

(C) Team Captain      n Starting line-up where n= starting pos      L Substitute Libero      nn Substitute where nn = shirt number  
Atts Attempts      L Libero      MB Middle Blocker      No. Shirt Number  
Opp. Opponent      OS Opposite Spiker      Pos Playing Position      Pts Points scored  
S Setter      WS Wing Spiker



TUE 28 JUN 2022  
Start Time 12:00 - End Time 13:22  
Match Duration 1h22  
Spectators 150

**Results**  
**P2**

**GRE vs MKD**  
**3 0**

Team	Sets	1	2	3	Total
GRE	3	25	25	25	75
MKD	0	18	16	19	53
	<b>Playing Time</b>	24min	26min	26min	1h16

First Referee: Moshira MOHAMED (EGY)

Second Referee: Nacer ZEBAR (ALG)

GRE - Greece								
No.	Name	Pos.	1	2	3	4	5	Pts
1	CHATZIEFSTRATIADOU Eirini	MB	4	3				3
4	KONSTANTINIDOU Lamprini	S	2	1	2			5
5	NIKOLGIANNI Asimina	WS			6			5
8	ILIOPOULOU Elisavet	S		9				
9	STRANTZALI Olga (C)	WS	5	4	5			12
13	XANTHOPOULOU Maria Aikaterini	WS	-1					
16	GENITSARIDI Maria	OS		4				1
19	SPANOU Anna Maria	WS	6	5				9
21	KYPARISSI Stamatia	WS	3	2	3			12
22	KLEPKOU Maria	L	L	L	L			
23	TERZOGLOU Kyriaki	MB			1			3
24	TSIOGKA Andromachi	MB	1	6	4			5

MKD - North Macedonia								
No.	Name	Pos.	1	2	3	4	5	Pts
1	POPJORDANOVSKA Emilija (C)	L	L	L	L			
2	BOSHKOVSKA Meri	OS			14			
3	STOJANOVSKA Simona	MB	6	1	6			4
4	STOJKOSKA Iva	MB	13	13				
7	STOJANOVA Tamara	WS	2	3	2			9
10	JONUZI Erjona	S	1	2	1			7
12	ANTESKA Nadica	L						
13	PAVLOSKA Ana	MB	3	4	3			5
14	DIKOVA Mila	OS	4	5	4			5
16	GJORGIEVSKA Mia	S			10			
17	TERZIEVSKA Tea	WS	5	6				2
18	HADJI TOSEVA Dobrina	WS		17	5			3

**Coach** ABBONDANZA Marcello  
**Assistant Coach** BOUTSOURIS Nikolaos

**Coach** PAUNOVIC Stefan  
**Assistant Coach**

**TEAM AND PLAYER PERFORMANCES**

Won	Total Atts	No. Name	Scoring Skills	Won	Total Atts	No. Name
43	83	<b>Total Team</b>	<b>Spike</b>	26	83	<b>Total Team</b>
9	14	19 SPANOU Anna Maria		9	29	7 STOJANOVA Tamara
9	20	9 STRANTZALI Olga		4	16	14 DIKOVA Mila
9	23	21 KYPARISSI Stamatia		4	8	3 STOJANOVSKA Simona
9	29	<b>Total Team</b>	<b>Block</b>	3	23	<b>Total Team</b>
3	5	23 TERZOGLOU Kyriaki		2	5	10 JONUZI Erjona
3	6	9 STRANTZALI Olga		1	7	13 PAVLOSKA Ana
2	6	21 KYPARISSI Stamatia				
3	73	<b>Total Team</b>	<b>Serve</b>	6	55	<b>Total Team</b>
2	17	4 KONSTANTINIDOU Lamprini		3	16	10 JONUZI Erjona
1	13	21 KYPARISSI Stamatia		2	7	13 PAVLOSKA Ana
				1	7	14 DIKOVA Mila
41		<b>Total Team</b>	<b>Opp. Error</b>	39		<b>Total Team</b>
96	185	<b>Total Team</b>	<b>Total</b>	74	161	<b>Total Team</b>
12	35	9 STRANTZALI Olga	<b>Best Scorer</b>	9	41	7 STOJANOVA Tamara

**LEGEND**

(C) Team Captain      n Starting line-up where n= starting pos      L Substitute Libero      nn Substitute where nn = shirt number  
Atts Attempts      L Libero      MB Middle Blocker      No. Shirt Number  
Opp. Opponent      OS Opposite Spiker      Pos Playing Position      Pts Points scored  
S Setter      WS Wing Spiker



TUE 28 JUN 2022  
Start Time 15:00 - End Time 17:03  
Match Duration 2h3  
Spectators 100

## Results

P2

EGY vs TUN  
3 1

Team	Sets	1	2	3	4	Total
EGY	3	25	25	21	25	96
TUN	1	21	21	25	14	81
	Playing Time	25min	35min	29min	24min	1h53

First Referee: VERRASCINA A. (ITA)

Second Referee: Ksenija JURKOVIC (CRO)

### EGY - Egypt

No.	Name	Pos.	1	2	3	4	5	Pts
1	ELSHAMY Aya	OS	19	5	4			9
4	MEAWAD Nada	WS	5	3	2	3		20
7	AHMED Mariam	L	L	L	L	L		
10	AHMED Maya	OS	4	1	1	5		12
11	HANAFY Sarah	OS		15				
12	ELASKALANY Farida (C)	MB	3	1	3	4		17
13	MAHFOUZ Laila	S	10					
15	ELELEMY Zeina	WS	2	6	5	6		11
19	SAYID Sohila	S	1	2	1	2		
20	MORSY Mariam	MB	6		6	1		7
22	MORSHEDY Dalila	MB		4	20	19		2

**Coach** MOHAMED Ahmed  
**Assistant Coach**

### TUN - Tunisia

No.	Name	Pos.	1	2	3	4	5	Pts
2	HAMOUDA Mouna	L	L	L	L	L		
4	GALAI Chourouk	MB	4	3	4	3		6
7	AGREBI Rahma (C)	WS	6	5	6	5		18
8	OTHMANI Abir	MB	1	6	1	6		2
10	ISMAIL Eya	OS	4	4	15	20		4
12	GHIZAOUI Ameni	WS		13		7		
13	BOURAOUI Sirine	WS	3	2	3	2		14
14	FATNASSI Hiba	S		15	20			
15	KEBAIER EP HMSSI Nihel	S	2	1	2	1		2
17	JENHANI Sahar	MB				8		
20	ABDA Nesrine	OS	5	4	5	4		18

**Coach** MESSELMANI Mohamed  
**Assistant Coach** LADJIMI Khaled

### TEAM AND PLAYER PERFORMANCES

Won	Total Atts	No. Name	Scoring Skills	Won	Total Atts	No. Name
66	139	<b>Total Team</b>	<b>Spike</b>	48	137	<b>Total Team</b>
19	48	4 MEAWAD Nada		18	44	7 AGREBI Rahma
11	22	10 AHMED Maya		13	37	13 BOURAOUI Sirine
11	22	12 ELASKALANY Farida		12	42	20 ABDA Nesrine
10	61	<b>Total Team</b>	<b>Block</b>	8	55	<b>Total Team</b>
5	17	12 ELASKALANY Farida		6	14	20 ABDA Nesrine
2	11	20 MORSY Mariam		1	8	8 OTHMANI Abir
1	1	1 ELSHAMY Aya		1	12	4 GALAI Chourouk
2	95	<b>Total Team</b>	<b>Serve</b>	8	82	<b>Total Team</b>
1	22	4 MEAWAD Nada		3	12	4 GALAI Chourouk
1	15	12 ELASKALANY Farida		2	7	10 ISMAIL Eya
				2	16	15 KEBAIER EP HMSSI Nihel
54		<b>Total Team</b>	<b>Opp. Error</b>	58		<b>Total Team</b>
132	295	<b>Total Team</b>	<b>Total</b>	122	274	<b>Total Team</b>

20	78	4 MEAWAD Nada	<b>Best Scorer</b>	18	60	7 AGREBI Rahma
----	----	---------------	--------------------	----	----	----------------

### LEGEND

(C)	Team Captain	n	Starting line-up where n= starting pos	L	Substitute Libero	nn	Substitute where nn = shirt number
Atts	Attempts	L	Libero	MB	Middle Blocker	No.	Shirt Number
Opp.	Opponent	OS	Opposite Spiker	Pos	Playing Position	Pts	Points scored
S	Setter	WS	Wing Spiker				



SUN 26 JUN 2022  
Start Time 18:00 - End Time 19:15  
Match Duration 1h15

## Results

P2

ITA vs ESP  
3 0

Team	Sets	1	2	3	Total
ITA	3	25	25	25	75
ESP	0	15	17	19	51
	Playing Time	22min	24min	23min	1h9

First Referee: Zied RIDENE (TUN)

Second Referee: Ehsan REJAEYAN (FRA)

ITA - Italy								
No.	Name	Pos.	1	2	3	4	5	Pts
2	BOSIO Francesca	S	1	6	1			7
13	BATTISTONI Ilaria	S		29				
16	D'ODORICO Sofia	WS		22				1
19	SQUARCINI Federica	MB	6	5	6			5
20	PANETONI Sara	L	L	L	L			
22	ENWEONWU Nkemdilim Terry	WS	2	1	2			6
23	PERINELLI Elena (C)	WS	5	4	5			11
24	MAZZARO Alessia	MB	3	2	3			12
27	CAGNIN Emma	WS			22			
28	DIOP Bintou	OS		2				1
29	FROSINI Giorgia	OS	4	3	4			10
36	NWAKALOR Linda Nkiruka	MB			24			1

ESP - Spain								
No.	Name	Pos.	1	2	3	4	5	Pts
5	VILLASANTE COSTA Laura	OS	9	10	3			2
6	RODRIGUEZ VILLANUEVA Elia	S	10					
7	PIZA HOMAR Margalida Victoria	L	L	L	L			
8	GARCIA CONRADO Carlota	MB	2	2	2			5
9	LAZARO CASTELLANOS Raquel	S	6	6	6			2
10	CARPINTERO P.	OS	3	3				2
12	VARELA GOMEZ Lucia	MB	5	5	5			4
15	PROL BRUNA Lucia (C)	WS	4					1
18	JIMENEZ RUIZ Carla	MB						
21	VILLA NAVARRO Ines	WS			24			1
22	LLORENS C.	WS	15	4	4			9
24	BRAVO CULEBRAS Denia	WS	1	1	1			4

**Coach** PIERAGNOLI Luca  
**Assistant Coach** SAJA Stefano / INGRATTA Matteo

**Coach** SAURIN CUTILLAS Pascual  
**Assistant Coach** GARCIA DIAZ Juan Diego / SALLERAS

### TEAM AND PLAYER PERFORMANCES

Won	Total Atts	No. Name	Scoring Skills	Won	Total Atts	No. Name
39	73	Total Team	Spike	22	73	Total Team
8	18	29 FROSINI Giorgia		8	22	22 LLORENS C.
8	14	23 PERINELLI Elena		3	17	24 BRAVO CULEBRAS Denia
7	7	24 MAZZARO Alessia		2	6	5 VILLASANTE COSTA Laura
2	28	Total Team	Block	6	25	Total Team
1	2	2 BOSIO Francesca		2	8	8 GARCIA CONRADO Carlota
1	5	24 MAZZARO Alessia		1	1	24 BRAVO CULEBRAS Denia
				1	4	10 CARPINTERO P.
13	74	Total Team	Serve	2	52	Total Team
4	18	24 MAZZARO Alessia		1	10	8 GARCIA CONRADO Carlota
3	15	23 PERINELLI Elena		1	8	12 VARELA GOMEZ Lucia
3	15	2 BOSIO Francesca				
21		Total Team	Opp. Error	21		Total Team
75	175	Total Team	Total	51	150	Total Team
12	30	24 MAZZARO Alessia	Best Scorer	9	30	22 LLORENS C.

#### LEGEND

(C)	Team Captain	n	Starting line-up where n= starting pos	L	Substitute Libero	nn	Substitute where nn = shirt number
Atts	Attempts	L	Libero	MB	Middle Blocker	No.	Shirt Number
Opp.	Opponent	OS	Opposite Spiker	Pos	Playing Position	Pts	Points scored
S	Setter	WS	Wing Spiker				
-	-						



SUN 26 JUN 2022  
Start Time 21:00 - End Time 22:08  
Match Duration 1h8

## Results

P2

### ALG vs TUR

0 3

Team	Sets	1	2	3	Total
ALG	0	16	4	13	33
TUR	3	25	25	25	75
	Playing Time	23min	17min	21min	1h1

First Referee: EYIKE M. (CMR)

Second Referee: Moshira MOHAMED (EGY)

ALG - Algeria								
No.	Name	Pos.	1	2	3	4	5	Pts
1	OUDAI Zina Mordjane	S	1	2				
3	HAMMOUCHE Salima	L	L	L	L			
5	BRAHMI Fahima	MB	3	4	3			3
6	DJOUHRI Wissem	OS			1			1
7	BECHAR Amira	WS						
8	BENSALEM Zohra (C)	WS	5	6	4			5
10	SOUALMI Melissa	OS	4	5				4
11	ABDERRAHIM Yasmine	WS	2	3	5			6
12	DJOUHRI Kahina	MB			6			
13	BELLAHSENE Radia Nadra	S		1				
14	RABAH-MAZARI Bekhta	WS		10	2			
15	MEZEMATE Aicha	MB	6	1				

TUR - Turkey								
No.	Name	Pos.	1	2	3	4	5	Pts
1	YILMAZ Melis	WS		-1				
2	AYDIN Ilkin	WS	3	2				6
3	ARICI Emine	MB			2			4
5	AKYALDIZ Ezgi	WS		2	1			1
8	UNAL Buse	S	2	1				2
9	KILIC Aslihan	S		17	3			1
10	AKYOL Aycin	MB	1	6	5			7
11	KAYACAN SONSIRMA Buse (C)	L	L	L	L			
17	YUZGENC Tutku Burcu	OS	5	4	6			14
18	YILDIRIM Yasemin	MB	4	3				6
19	CEBECIOGLU Derya	WS		8	4			6
20	ERKEK Yaprak	WS	6	5				8

**Coach** TENNOUN Nabil  
**Assistant Coach** MOHAMED BENATTIA Belkacem /

**Coach** ALPER Hamurcu  
**Assistant Coach** CANER Atasever / SIBEL Kahyalioğlu

#### TEAM AND PLAYER PERFORMANCES

Won	Total Atts	No.	Name	Scoring Skills	Won	Total Atts	No.	Name
18	74	Total	Team	Spike	39	64	Total	Team
6	25	11	ABDERRAHIM Yasmine		10	19	17	YUZGENC Tutku Burcu
5	24	8	BENSALEM Zohra		7	8	20	ERKEK Yaprak
3	7	5	BRAHMI Fahima		5	9	10	AKYOL Aycin
1	18	Total	Team	Block	9	30	Total	Team
1	1	10	SOUALMI Melissa		3	5	17	YUZGENC Tutku Burcu
					2	9	10	AKYOL Aycin
					2	5	18	YILDIRIM Yasemin
0	35	Total	Team	Serve	7	73	Total	Team
					2	6	3	ARICI Emine
					1	11	20	ERKEK Yaprak
					1	7	18	YILDIRIM Yasemin
24		Total	Team	Opp. Error	54		Total	Team
43	127	Total	Team	Total	109	167	Total	Team
6	37	11	ABDERRAHIM Yasmine	Best Scorer	14	31	17	YUZGENC Tutku Burcu

LEGEND			
(C)	Team Captain	n	Starting line-up where n= starting pos
Atts	Attempts	L	Libero
Opp.	Opponent	OS	Opposite Spiker
S	Setter	WS	Wing Spiker
-	-	L	Substitute Libero
		MB	Middle Blocker
		Pos	Playing Position
		nn	Substitute where nn = shirt number
		No.	Shirt Number
		Pts	Points scored





MON 27 JUN 2022  
Start Time 18:00 - End Time 19:58  
Match Duration 1h58  
Spectators 300

**Results**  
**P2**

**TUR vs ITA**  
**3 1**

Team	Sets	1	2	3	4	Total
TUR	3	26	25	19	25	95
ITA	1	24	19	25	21	89
	<b>Playing Time</b>	27min	27min	25min	30min	1h49

First Referee: Moshira MOHAMED (EGY)

Second Referee: Zied RIDENE (TUN)

TUR - Turkiye								
No.	Name	Pos.	1	2	3	4	5	Pts
1	YILMAZ Melis	L					L	
2	AYDIN Ilkin	WS	2	1	1	5		21
3	ARICI Emine	MB	18		18			
5	AKYALDIZ Ezgi	WS						
8	UNAL Buse	S	1	6	6	4		3
9	KILIC Aslihan	S	17	17	17			1
10	AKYOL Aycin	MB	6	5	5	3		13
11	KAYACAN SONSIRMA Buse (C)	L	L	L	L	L		
17	YUZGENC Tutku Burcu	OS	4	3	3			7
18	YILDIRIM Yasemin	MB	3	2	2	6		5
19	CEBECIOGLU Derya	WS		8	8	1		7
20	ERKEK Yaprak	WS	5	4	4	2		9

**Coach** ALPER Hamurcu  
**Assistant Coach** CANER Atasever / SIBEL Kahyalioglu

ITA - Italy								
No.	Name	Pos.	1	2	3	4	5	Pts
2	BOSIO Francesca	S	6	1	3	3		5
13	BATTISTONI Ilaria	S				2		
16	D'ODORICO Sofia	WS		23	1	4		9
19	SQUARCINI Federica	MB	5	6	2	2		14
20	PANETONI Sara	L	L	L	L	L		
22	ENWEONWU Nkemdiim Terry	WS	1					1
23	PERINELLI Elena (C)	WS	4	5				4
24	MAZZARO Alessia	MB	2	3	5	5		7
27	CAGNIN Emma	WS	22	2	4	1		11
28	DIOP Bintou	OS	3	4	6	6		23
29	FROSINI Giorgia	OS		28				
36	NWAKALOR Linda Nkiruka	MB						

**Coach** PIERAGNOLI Luca  
**Assistant Coach** SAJA Stefano / INGRATTA Matteo

**TEAM AND PLAYER PERFORMANCES**

Won	Total Atts	No.	Name	Scoring Skills	Won	Total Atts	No.	Name
53	112	Total	Team	Spike	61	130	Total	Team
20	35	2	AYDIN Ilkin		20	43	28	DIOP Bintou
7	12	10	AKYOL Aycin		10	22	27	CAGNIN Emma
7	22	17	YUZGENC Tutku Burcu		10	17	19	SQUARCINI Federica
9	59	Total	Team	Block	9	50	Total	Team
5	18	10	AKYOL Aycin		4	18	19	SQUARCINI Federica
2	10	20	ERKEK Yaprak		2	8	2	BOSIO Francesca
2	15	18	YILDIRIM Yasemin		1	10	24	MAZZARO Alessia
4	94	Total	Team	Serve	4	90	Total	Team
1	14	10	AKYOL Aycin		2	16	2	BOSIO Francesca
1	13	18	YILDIRIM Yasemin		2	16	28	DIOP Bintou
1	16	2	AYDIN Ilkin					
69		Total	Team	Opp. Error	53		Total	Team
135	265	Total	Team	Total	127	270	Total	Team
21	58	2	AYDIN Ilkin	Best Scorer	23	68	28	DIOP Bintou

LEGEND			
(C)	Team Captain	n	Starting line-up where n= starting pos
Atts	Attempts	L	Libero
Opp.	Opponent	OS	Opposite Spiker
S	Setter	WS	Wing Spiker
-	-	L	Substitute Libero
		MB	Middle Blocker
		Pos	Playing Position
		nn	Substitute where nn = shirt number
		No.	Shirt Number
		Pts	Points scored



MON 27 JUN 2022  
Start Time 21:00 - End Time 22:32  
Match Duration 1h32  
Spectators 1000

## Results

P2

ESP vs ALG  
3 0

Team	Sets	1	2	3	Total
ESP	3	25	29	25	79
ALG	0	23	27	18	68
	Playing Time	28min	34min	24min	1h26

First Referee: Ehsan REJAEYAN (FRA)

Second Referee: VERRASCINA A. (ITA)

ESP - Spain								
No.	Name	Pos.	1	2	3	4	5	Pts
5	VILLASANTE COSTA Laura	OS						
6	RODRIGUEZ VILLANUEVA Elia	S						
7	PIZA HOMAR Margalida Victoria	L	L	L	L			
8	GARCIA CONRADO Carlota	MB	2	2	2			4
9	LAZARO CASTELLANOS Raquel	S	6	6	6			
10	CARPINTERO P.	OS	3	3	3			16
12	VARELA GOMEZ Lucia	MB	5	5	5			14
15	PROL BRUNA Lucia (C)	WS	4	4	4			10
18	JIMENEZ RUIZ Carla	MB						
21	VILLA NAVARRO Ines	WS		8	8			
22	LLORENS C.	WS	8	24	1			4
24	BRAVO CULEBRAS Denia	WS	1	1				1

ALG - Algeria								
No.	Name	Pos.	1	2	3	4	5	Pts
1	OUDAI Zina Mordjane	S	1	6	6			
3	HAMMOUCHE Salima	L	L	L	L			
5	BRAHMI Fahima	MB						
6	DJOUHRI Wissem	OS	1	1	1			
7	BECHAR Amira	WS						
8	BENSALEM Zohra (C)	WS	2	1	2			17
10	SOUALMI Melissa	OS	4	3				4
11	ABDERRAHIM Yasmine	WS	5	4	5			18
12	DJOUHRI Kahina	MB	3	2	3			3
13	BELLAHSENE Radia Nadra	S						
14	RABAH-MAZARI Bekhta	WS		10	4			1
15	MEZEMATE Aicha	MB	6	5	6			4

**Coach** SAURIN CUTILLAS Pascual  
**Assistant Coach** GARCIA DIAZ Juan Diego / SALLERAS

**Coach** TENNOUN Nabil  
**Assistant Coach** MOHAMED BENATTIA Belkacem /

### TEAM AND PLAYER PERFORMANCES

Won	Total Atts	No. Name	Scoring Skills	Won	Total Atts	No. Name
36	92	Total Team	Spike	41	115	Total Team
15	28	10 CARPINTERO P.		18	42	11 ABDERRAHIM Yasmine
7	23	15 PROL BRUNA Lucia		15	37	8 BENSALEM Zohra
7	18	12 VARELA GOMEZ Lucia		3	6	15 MEZEMATE Aicha
11	38	Total Team	Block	3	22	Total Team
5	8	12 VARELA GOMEZ Lucia		1	5	8 BENSALEM Zohra
3	8	15 PROL BRUNA Lucia		1	7	12 DJOUHRI Kahina
2	7	8 GARCIA CONRADO Carlota		1	3	15 MEZEMATE Aicha
2	78	Total Team	Serve	3	69	Total Team
2	11	12 VARELA GOMEZ Lucia		2	11	10 SOUALMI Melissa
				1	12	8 BENSALEM Zohra
46		Total Team	Opp. Error	41		Total Team
95	208	Total Team	Total	88	206	Total Team

16	44	10 CARPINTERO P.	Best Scorer	18	61	11 ABDERRAHIM Yasmine
----	----	------------------	-------------	----	----	-----------------------

#### LEGEND

(C)	Team Captain	n	Starting line-up where n= starting pos	L	Substitute Libero	nn	Substitute where nn = shirt number
Atts	Attempts	L	Libero	MB	Middle Blocker	No.	Shirt Number
Opp.	Opponent	OS	Opposite Spiker	Pos	Playing Position	Pts	Points scored
S	Setter	WS	Wing Spiker				
-	-						



TUE 28 JUN 2022  
Start Time 18:00 - End Time 19:59  
Match Duration 1h59  
Spectators 300

**Results**  
**P2**

**TUR vs ESP**  
**3 1**

Team	Sets	1	2	3	4	Total
TUR	3	22	25	25	25	97
ESP	1	25	16	18	18	77
	<b>Playing Time</b>	28min	25min	28min	29min	1h50

First Referee: Eirini MOULA (GRE)

Second Referee: Dejan ROGIC (SRB)

TUR - Turkiye								
No.	Name	Pos.	1	2	3	4	5	Pts
1	YILMAZ Melis	L					L	
2	AYDIN Ilkin	WS	2	2	1	2		14
3	ARICI Emine	MB					18	1
5	AKYALDIZ Ezgi	WS						
8	UNAL Buse	S	1	1	6	1		6
9	KILIC Aslihan	S						
10	AKYOL Aycin	MB	6	6	5	6		10
11	KAYACAN SONSIRMA Buse (C)	L	L	L	L	L		
17	YUZGENC Tutku Burcu	OS	4	4	3	4		15
18	YILDIRIM Yasemin	MB	3	3	2	3		5
19	CEBECIOGLU Derya	WS	5					1
20	ERKEK Yaprak	WS	19	5	4	5		21

ESP - Spain								
No.	Name	Pos.	1	2	3	4	5	Pts
5	VILLASANTE COSTA Laura	OS						
6	RODRIGUEZ VILLANUEVA Elia	S						
7	PIZA HOMAR Margalida Victoria	L	L	L	L	L		
8	GARCIA CONRADO Carlota	MB	2	2	2	3		6
9	LAZARO CASTELLANOS Raquel	S	6	6	6	1		3
10	CARPINTERO P.	OS	3	3	3	4		18
12	VARELA GOMEZ Lucia	MB	5	5	5	6		15
15	PROL BRUNA Lucia (C)	WS	4	4	4	5		14
18	JIMENEZ RUIZ Carla	MB						
21	VILLA NAVARRO Ines	WS		24	8			
22	LLORENS C.	WS		15		15		1
24	BRAVO CULEBRAS Denia	WS	1	1	1	2		9

**Coach** ALPER Hamurcu  
**Assistant Coach** CANER Atasever / SIBEL Kahyalioglu

**Coach** SAURIN CUTILLAS Pascual  
**Assistant Coach** GARCIA DIAZ Juan Diego / SALLERAS

**TEAM AND PLAYER PERFORMANCES**

Won	Total Atts	No. Name	Scoring Skills	Won	Total Atts	No. Name
50	127	Total Team	Spike	49	139	Total Team
17	38	20 ERKEK Yaprak		17	48	10 CARPINTERO P.
12	34	17 YUZGENC Tutku Burcu		13	38	15 PROL BRUNA Lucia
10	26	2 AYDIN Ilkin		7	26	24 BRAVO CULEBRAS Denia
14	62	Total Team	Block	10	48	Total Team
3	11	8 UNAL Buse		5	14	12 VARELA GOMEZ Lucia
2	13	10 AKYOL Aycin		2	5	24 BRAVO CULEBRAS Denia
2	8	18 YILDIRIM Yasemin		2	6	8 GARCIA CONRADO Carlota
9	96	Total Team	Serve	7	78	Total Team
3	16	8 UNAL Buse		3	11	9 LAZARO CASTELLANOS Raquel
2	15	20 ERKEK Yaprak		3	13	12 VARELA GOMEZ Lucia
2	19	2 AYDIN Ilkin		1	15	10 CARPINTERO P.
24		Total Team	Opp. Error	11		Total Team
97	285	Total Team	Total	77	265	Total Team
21	61	20 ERKEK Yaprak	Best Scorer	18	67	10 CARPINTERO P.

**LEGEND**

(C) Team Captain      n Starting line-up where n= starting pos      L Substitute Libero      nn Substitute where nn = shirt number  
Atts Attempts      L Libero      MB Middle Blocker      No. Shirt Number  
Opp. Opponent      OS Opposite Spiker      Pos Playing Position      Pts Points scored  
S Setter      WS Wing Spiker



TUE 28 JUN 2022  
Start Time 21:00 - End Time 22:19  
Match Duration 1h19  
Spectators 1000

## Results

P2

ITA vs ALG  
3 0

Team	Sets	1	2	3	Total
ITA	3	25	25	25	75
ALG	0	11	14	18	43
	Playing Time	24min	23min	26min	1h13

First Referee: EYIKE M. (CMR)

Second Referee: CORREA BENITEZ (ESP)

ITA - Italy								
No.	Name	Pos.	1	2	3	4	5	Pts
2	BOSIO Francesca	S	6	1	6			3
13	BATTISTONI Ilaria	S		2	28			
16	D'ODORICO Sofia	WS	22	5	4			7
19	SQUARCINI Federica	MB	5	6	5			11
20	PANETONI Sara	L	L	L	L			
22	ENWEONWU Nkemdilim Terry	WS	1					1
23	PERINELLI Elena (C)	WS	4		16			1
24	MAZZARO Alessia	MB	2	3	2			7
27	CAGNIN Emma	WS	23	2	1			8
28	DIOP Bintou	OS	3	4	3			9
29	FROSINI Giorgia	OS		28	2			5
36	NWAKALOR Linda Nkiruka	MB		19	24			2

ALG - Algeria								
No.	Name	Pos.	1	2	3	4	5	Pts
1	OUDAI Zina Mordjane	S	6	1				
3	HAMMOUCHE Salima	L	L	L	L			
5	BRAHMI Fahima	MB	2	3				3
6	DJOUHRI Wissem	OS						
7	BECHAR Amira	WS			3			1
8	BENSALEM Zohra (C)	WS	1	2	1			3
10	SOUALMI Melissa	OS						
11	ABDERRAHIM Yasmine	WS	4	5	4			7
12	DJOUHRI Kahina	MB	5	6	5			4
13	BELLAHSENE Radia Nadra	S		1	6			
14	RABAH-MAZARI Bekhta	WS	11	15	15			3
15	MEZEMATE Aicha	MB	3	4	2			7

**Coach** PIERAGNOLI Luca  
**Assistant Coach** SAJA Stefano / INGRATTA Matteo

**Coach** TENNOUN Nabil  
**Assistant Coach** MOHAMED BENATTIA Belkacem /

### TEAM AND PLAYER PERFORMANCES

Won	Total Atts	No. Name	Scoring Skills	Won	Total Atts	No. Name
36	95	<b>Total Team</b>	<b>Spike</b>	25	87	<b>Total Team</b>
7	23	27 CAGNIN Emma		6	19	11 ABDERRAHIM Yasmine
6	10	16 D'ODORICO Sofia		5	16	15 MEZEMATE Aicha
6	18	28 DIOP Bintou		4	8	12 DJOUHRI Kahina
9	33	<b>Total Team</b>	<b>Block</b>	3	30	<b>Total Team</b>
2	11	19 SQUARCINI Federica		2	11	15 MEZEMATE Aicha
2	3	24 MAZZARO Alessia		1	2	11 ABDERRAHIM Yasmine
1	5	16 D'ODORICO Sofia				
9	73	<b>Total Team</b>	<b>Serve</b>	0	45	<b>Total Team</b>
4	11	19 SQUARCINI Federica				
2	12	28 DIOP Bintou				
1	13	24 MAZZARO Alessia				
21		<b>Total Team</b>	<b>Opp. Error</b>	15		<b>Total Team</b>
75	201	<b>Total Team</b>	<b>Total</b>	43	162	<b>Total Team</b>
11	32	19 SQUARCINI Federica	<b>Best Scorer</b>	7	35	15 MEZEMATE Aicha

#### LEGEND

(C) Team Captain  
Atts Attempts  
Opp. Opponent  
S Setter  
- -

n Starting line-up where n= starting pos  
L Libero  
OS Opposite Spiker  
WS Wing Spiker

L Substitute Libero  
MB Middle Blocker  
Pos Playing Position

nn Substitute where nn = shirt number  
No. Shirt Number  
Pts Points scored



## Results Table - Final Round

P4

As of MON 4 JUL 2022 at 22:07

Match	Phase	Date	Teams	Sets	Points per Set					Total Points	Match Duration	Spectators
					1	2	3	4	5			
32	Quarter-finals	THU 30 JUN 2022	SRB vs EGY	3 - 1	25 - 11	25 - 20	25 - 27	25 - 21		100 - 79	2:02	200
34	Quarter-finals	THU 30 JUN 2022	CRO vs ITA	0 - 3	18 - 25	16 - 25	19 - 25			53 - 75	1:30	700
36	Quarter-finals	THU 30 JUN 2022	GRE vs ESP	0 - 3	22 - 25	22 - 25	22 - 25			66 - 75	1:38	600
38	Quarter-finals	THU 30 JUN 2022	TUR vs TUN	3 - 0	25 - 14	25 - 15	25 - 17			75 - 46	1:16	600
39	Semifinals 5-8	FRI 1 JUL 2022	EGY vs TUN	3 - 1	25 - 12	21 - 25	25 - 18	25 - 21		96 - 76	1:58	300
40	Semifinals 5-8	FRI 1 JUL 2022	CRO vs GRE	1 - 3	25 - 20	22 - 25	23 - 25	19 - 25		89 - 95	2:08	400
43	Final 7th-8th Place	SAT 2 JUL 2022	TUN vs CRO	0 - 3	19 - 25	12 - 25	20 - 25			51 - 75	1:17	100
44	Final 5th-6th Place	SAT 2 JUL 2022	EGY vs GRE	1 - 3	25 - 17	16 - 25	17 - 25	21 - 25		79 - 92	1:53	150
47	Semi-finals	SAT 2 JUL 2022	SRB vs TUR	0 - 3	21 - 25	14 - 25	22 - 25			57 - 75	1:27	800
48	Semi-finals	SAT 2 JUL 2022	ITA vs ESP	3 - 0	25 - 19	25 - 19	25 - 22			75 - 60	1:23	2500
51	Bronze-medal Match	MON 4 JUL 2022	SRB vs ESP	3 - 2	16 - 25	25 - 18	20 - 25	25 - 16	15 - 10	101 - 94	2:06	400
53	Gold-medal Match	MON 4 JUL 2022	TUR vs ITA	1 - 3	24 - 26	20 - 25	25 - 22	22 - 25		91 - 98	2:17	3000

Statistics of	Average match duration	Average spectators	Total spectators
Preliminary	1h43	217	3250
Final Rounds	1h45	813	9750
Tournament	1h44	481	13000

### Quarterfinal Round Semifinal Round Final Round

#### SRB - Serbia

Match 32, 30 JUN 10:00

EGY - Egypt

SRB - Serbia 3 - 1

Match 47, 2 JUL 10:00

TUR - Turkiye

Match 38, 30 JUN 19:00

TUN - Tunisia

TUR - Turkiye 3 - 0

TUR - Turkiye 3 - 0

Match 53, 4 JUL 16:30

ITA 3 - 1

1 ITA - Italy

2 TUR - Turkiye

CRO - Croatia

Match 34, 30 JUN 13:00

ITA - Italy

ITA - Italy 3 - 0

Match 48, 2 JUL 13:00

GRE - Greece

Match 36, 30 JUN 16:00

ESP - Spain

ESP - Spain 3 - 0

ITA - Italy 3 - 0

SRB - Serbia

Match 51, 4 JUL 09:30

ESP - Spain

SRB 3 - 2

3 SRB - Serbia

4 ESP - Spain



## Results Table - Final Round

P4

As of MON 4 JUL 2022 at 22:07

### EGY - Egypt

Match 39, 1 JUL 09:30

**TUN - Tunisia**

**CRO - Croatia**

Match 40, 1 JUL 12:30

**GRE - Greece**

**EGY - Egypt 3 - 1**

Match 44, 2 JUL 12:30

**GRE - Greece 3 - 1**

**GRE 3 - 1**

5 **GRE - Greece**

6 **EGY - Egypt**

**TUN - Tunisia**

Match 43, 2 JUL 09:30

**CRO - Croatia**

**CRO 3 - 0**

7 **CRO - Croatia**

8 **TUN - Tunisia**

### LEGEND

**Ax** x (x=1-4) ranked team from pool A    **Bx** x (x=1-4) ranked team from pool B



THU 30 JUN 2022  
Start Time 10:02 - End Time 12:04  
Match Duration 2h2  
Spectators 200

## Results

P2

SRB vs EGY  
3 1

Team	Sets	1	2	3	4	Total
SRB	3	25	25	25	25	100
EGY	1	11	20	27	21	79
	Playing Time	23min	24min	37min	26min	1h52

First Referee: Ehsan REJAEYAN (FRA)

Second Referee: EYIKE M. (CMR)

SRB - Serbia								
No.	Name	Pos.	1	2	3	4	5	Pts
1	TAUBNER Tara	L		L				
2	TISMA Andrea	S						
3	OSMAJIC Minja	MB	3	2	3	2		15
4	GOCANIN Bojana	L	L	L	L	L		
10	CVETKOVIC Jovana	WS		15	5	4		7
11	KURTAGIC Hena	MB	6	5	6			4
12	MALESEVIC Ana	MB			11	5		4
14	SAVIC Vanja	WS	4	3	4	3		32
15	KOCKAREVIC Isidora	WS	5	4	10			2
18	TICA Branka	WS	2	1	2	1		13
21	IVANOVIC Vanja	WS				14		1
30	PEROVIC Rada (C)	S	1	6	1	6		3

EGY - Egypt								
No.	Name	Pos.	1	2	3	4	5	Pts
1	ELSHAMY Aya	OS	5	19	19	19		1
4	MEAWAD Nada	WS	3	5	6	5		10
7	AHMED Mariam	L	L	L	L	L		
8	ABDELFAHATTAH Nahla (C)	WS						
10	AHMED Maya	OS	1	4	5	4		11
11	HANAFY Sarah	OS	4	2	3	2		5
12	ELASKALANY Farida	MB		22	11	22		2
13	MAHFOUZ Laila	S		10				
15	ELELEMY Zeina	WS	6					1
19	SAYID Sohila	S	2	1	2	1		2
20	MORSY Mariam	MB	1	6	1	6		14
22	MORSHEDEY Dalia	MB	4	3	4	3		3

**Coach** BORICIC Marijana  
**Assistant Coach** JELESIC Milan / KOVACEVIC Dusan /

**Coach** MOHAMED Ahmed  
**Assistant Coach**

### TEAM AND PLAYER PERFORMANCES

Won	Total Atts	No. Name	Scoring Skills	Won	Total Atts	No. Name
57	133	Total Team	Spike	36	115	Total Team
22	41	14 SAVIC Vanja		10	15	20 MORSY Mariam
11	32	18 TICA Branka		8	34	4 MEAWAD Nada
10	16	3 OSMAJIC Minja		8	25	10 AHMED Maya
16	46	Total Team	Block	10	47	Total Team
5	8	14 SAVIC Vanja		4	9	20 MORSY Mariam
4	11	3 OSMAJIC Minja		2	5	10 AHMED Maya
2	6	10 CVETKOVIC Jovana		1	6	4 MEAWAD Nada
8	99	Total Team	Serve	3	80	Total Team
5	17	14 SAVIC Vanja		1	10	4 MEAWAD Nada
2	35	30 PEROVIC Rada		1	8	10 AHMED Maya
1	15	3 OSMAJIC Minja		1	16	19 SAYID Sohila
19		Total Team	Opp. Error	30		Total Team
100	278	Total Team	Total	79	242	Total Team
32	66	14 SAVIC Vanja	Best Scorer	14	35	20 MORSY Mariam

#### LEGEND

(C) Team Captain      n Starting line-up where n= starting pos      L Substitute Libero      nn Substitute where nn = shirt number  
Atts Attempts      L Libero      MB Middle Blocker      No. Shirt Number  
Opp. Opponent      OS Opposite Spiker      Pos Playing Position      Pts Points scored  
S Setter      WS Wing Spiker



THU 30 JUN 2022

Start Time 19:00 - End Time 20:16

Match Duration 1h16

Spectators 600

## Results

P2

### TUR vs TUN 3 0

Team	Sets	1	2	3	Total
TUR	3	25	25	25	75
TUN	0	14	15	17	46
	Playing Time	22min	24min	24min	1h10

First Referee: CORREA BENITEZ (ESP)

Second Referee: Eirini MOULA (GRE)

#### TUR - Turkiye

No.	Name	Pos.	1	2	3	4	5	Pts
1	YILMAZ Melis	L	L	L	L			
2	AYDIN Ilkin	WS	2	1				3
3	ARICI Emine	MB			10			3
5	AKYALDIZ Ezgi	WS		2	2			6
8	UNAL Buse	S	1	6				1
9	KILIC Aslihan	S	17	17	1			
10	AKYOL Aycin	MB	6	5	6			7
11	KAYACAN SONSIRMA Buse (C)	L	L	L	L			
17	YUZGENC Tutku Burcu	OS	4	3				11
18	YILDIRIM Yasemin	MB	3	2	3			6
19	CEBECIOGLU Derya	WS	8	8	4			8
20	ERKEK Yaprak	WS	5	4	5			9

**Coach**

ALPER Hamurcu

**Assistant Coach** CANER Atasever / SIBEL Kahyalioglu

#### TUN - Tunisia

No.	Name	Pos.	1	2	3	4	5	Pts
2	HAMOUDA Mouna	L	L	L	L			
3	ENGZOU Dhouha							
4	GALAI Chourouk	MB	4	3	4			1
7	AGREBI Rahma (C)	OS	6	5	6			5
8	OTHMANI Abir	MB	1	6	1			
10	ISMAIL Eya	OS	15	4	15			1
12	GHIZAOUI Ameni	WS			13			
13	BOURAOUI Sirine	WS	3	2	3			7
14	FATNASSI Hiba	S		15	20			
15	KEBAIER EP HMSSI Nihel	S	2	1	2			1
17	JENHANI Sahar	MB			4			
20	ABDA Nesrine	OS	5	4	5			10

**Coach**

**Assistant Coach**

#### TEAM AND PLAYER PERFORMANCES

Won	Total Atts	No.	Name	Scoring Skills	Won	Total Atts	No.	Name
41	88	Total	Team	Spike	23	91	Total	Team
9	15	17	YUZGENC Tutku Burcu		8	39	20	ABDA Nesrine
6	7	10	AKYOL Aycin		7	19	13	BOURAOUI Sirine
6	16	19	CEBECIOGLU Derya		5	19	7	AGREBI Rahma
10	37	Total	Team	Block	2	21	Total	Team
2	8	18	YILDIRIM Yasemin		2	2	20	ABDA Nesrine
2	3	17	YUZGENC Tutku Burcu					
2	6	19	CEBECIOGLU Derya					
3	74	Total	Team	Serve	0	47	Total	Team
3	16	20	ERKEK Yaprak					
21		Total	Team	Opp. Error	21		Total	Team
75	199	Total	Team	Total	46	159	Total	Team

11	24	17	YUZGENC Tutku Burcu	Best Scorer	10	47	20	ABDA Nesrine
----	----	----	---------------------	-------------	----	----	----	--------------

#### LEGEND

(C) Team Captain

Atts Attempts

Opp. Opponent

S Setter

n Starting line-up where n= starting pos

L Libero

OS Opposite Spiker

WS Wing Spiker

L Substitute Libero

MB Middle Blocker

Pos Playing Position

nn Substitute where nn = shirt number

No. Shirt Number

Pts Points scored





THU 30 JUN 2022  
Start Time 12:57 - End Time 14:28  
Match Duration 1h30  
Spectators 700

## Results

P2

CRO vs ITA  
0 3

Team	Sets	1	2	3	Total
CRO	0	18	16	19	53
ITA	3	25	25	25	75
	Playing Time	28min	30min	26min	1h25

First Referee: Zied RIDENE (TUN)

Second Referee: Nacer ZEBAR (ALG)

CRO - Croatia								
No.	Name	Pos.	1	2	3	4	5	Pts
2	GRBAVICA Mika	OS	L	L	L			8
4	BUTIGAN Bozana	MB	5	5	5			10
5	BOZICEVIC Nikolina	L			L			
6	PERIC Klara	S						
7	MILOS Laura	WS	1	1				6
8	POPIC Astrid	MB					11	
11	DUMANCIC Beta	MB	3	3	3			5
12	MARKOVIC Josipa	WS	11	7	1			1
14	SAMADAN Martina	MB	2	2	2			6
16	DEAK Lea	S	6	6	6			2
19	STIMAC Izabela	L	L	L	L			
20	TOMIC Natalia	WS					12	2

ITA - Italy								
No.	Name	Pos.	1	2	3	4	5	Pts
2	BOSIO Francesca	S	6	6	6			4
13	BATTISTONI Ilaria	S						
16	D'ODORICO Sofia	WS	1	1	1			10
19	SQUARCINI Federica	MB	5	5	5			10
20	PANETONI Sara	L	L	L	L			
23	PERINELLI Elena	WS	4	4	4			8
24	MAZZARO Alessia	MB	2	2	2			9
27	CAGNIN Emma	WS					16	
28	DIOP Bintou	OS	3	3	3			16
29	FROSINI Giorgia	OS						
36	NWAKALOR Linda Nkiruka	MB						

**Coach** AKBAS Ferhat  
**Assistant Coach** MATELA Piotr Jerzy / MICHALSKI Krzysztof

**Coach** PIERAGNOLI Luca  
**Assistant Coach** SAJA Stefano / INGRATTA Matteo

### TEAM AND PLAYER PERFORMANCES

Won	Total Atts	No.	Name	Scoring Skills	Won	Total Atts	No.	Name
27	80	Total	Team	Spike	41	87	Total	Team
7	16	4	BUTIGAN Bozana		13	22	28	DIOP Bintou
7	21	2	GRBAVICA Mika		8	21	23	PERINELLI Elena
4	9	7	MILOS Laura		7	14	19	SQUARCINI Federica
9	38	Total	Team	Block	5	28	Total	Team
3	12	4	BUTIGAN Bozana		2	8	24	MAZZARO Alessia
2	4	11	DUMANCIC Beta		1	5	2	BOSIO Francesca
2	12	14	SAMADAN Martina		1	6	28	DIOP Bintou
4	54	Total	Team	Serve	11	74	Total	Team
1	13	2	GRBAVICA Mika		4	21	16	D'ODORICO Sofia
1	4	7	MILOS Laura		2	10	19	SQUARCINI Federica
1	8	14	SAMADAN Martina		2	13	24	MAZZARO Alessia
13		Total	Team	Opp. Error	18		Total	Team
53	172	Total	Team	Total	75	189	Total	Team

10	36	4	BUTIGAN Bozana	Best Scorer	16	42	28	DIOP Bintou
----	----	---	----------------	-------------	----	----	----	-------------

#### LEGEND

(C) Team Captain      n Starting line-up where n= starting pos      L Substitute Libero      nn Substitute where nn = shirt number  
Atts Attempts      L Libero      MB Middle Blocker      No. Shirt Number  
Opp. Opponent      OS Opposite Spiker      Pos Playing Position      Pts Points scored  
S Setter      WS Wing Spiker



THU 30 JUN 2022  
Start Time 16:00 - End Time 17:38  
Match Duration 1h38  
Spectators 600

Results  
P2

GRE vs ESP  
0 3

Team	Sets	1	2	3	Total
GRE	0	22	22	22	66
ESP	3	25	25	25	75
	Playing Time	30min	34min	28min	1h32

First Referee: VERRASCINA A. (ITA)

Second Referee: Moshira MOHAMED (EGY)

GRE - Greece								
No.	Name	Pos.	1	2	3	4	5	Pts
1	CHATZIEFSTRATIADOU Eirini	MB	1	6	2			1
4	KONSTANTINIDOU Lamprini	S	5	4	6			4
5	NIKOLOGIANNI Asimina	WS	3	2				4
8	ILIOPOULOU Elisavet	S		4				
9	STRANTZALI Olga (C)	WS	2	1	1			16
13	XANTHOPOULOU Maria Aikaterini	L	L	L	L			
16	GENITSARIDI Maria	OS	21		3			5
19	SPANOU Anna Maria	WS	5	5	23			5
21	KYPARISSI Stamatia	WS	6	5	4			12
22	KLEPKOU Maria	WS						
23	TERZOGLOU Kyriaki	MB	4	3	5			3
24	TSIOGKA Andromachi	MB		1				

ESP - Spain								
No.	Name	Pos.	1	2	3	4	5	Pts
5	VILLASANTE COSTA Laura	OS						
6	RODRIGUEZ VILLANUEVA Elia	S						
7	PIZA HOMAR Margalida Victoria	L	L	L	L			
8	GARCIA CONRADO Carlota	MB	2	2	2			6
9	LAZARO CASTELLANOS Raquel	S	6	6	6			4
10	CARPINTERO P.	OS	3	3	3			11
12	VARELA GOMEZ Lucia	MB	5	5	5			10
15	PROL BRUNA Lucia (C)	WS	4	4	4			16
18	JIMENEZ RUIZ Carla	MB						
21	VILLA NAVARRO Ines	WS						
22	LLORENS C.	WS	15					
24	BRAVO CULEBRAS Denia	WS	1	1	1			10

**Coach** ABBONDANZA Marcello  
**Assistant Coach** BOUTSOURIS Nikolaos / ALPI Daniele

**Coach** SAURIN CUTILLAS Pascual  
**Assistant Coach** GARCIA DIAZ Juan Diego / SALLERAS

TEAM AND PLAYER PERFORMANCES

Won	Total Atts	No. Name	Scoring Skills	Won	Total Atts	No. Name
39	99	Total Team	Spike	46	105	Total Team
12	32	9 STRANTZALI Olga		15	31	15 PROL BRUNA Lucia
11	27	21 KYPARISSI Stamatia		10	27	10 CARPINTERO P.
5	14	16 GENITSARIDI Maria		8	25	24 BRAVO CULEBRAS Denia
7	48	Total Team	Block	8	39	Total Team
3	8	23 TERZOGLOU Kyriaki		4	16	9 LAZARO CASTELLANOS Raquel
2	4	9 STRANTZALI Olga		2	7	12 VARELA GOMEZ Lucia
1	6	21 KYPARISSI Stamatia		1	3	15 PROL BRUNA Lucia
4	67	Total Team	Serve	4	74	Total Team
2	13	9 STRANTZALI Olga		1	10	10 CARPINTERO P.
1	17	4 KONSTANTINIDOU Lamprini		1	15	8 GARCIA CONRADO Carlota
1	7	1 CHATZIEFSTRATIADOU Eirini		1	10	12 VARELA GOMEZ Lucia
16		Total Team	Opp. Error	17		Total Team
66	214	Total Team	Total	75	218	Total Team
16	49	9 STRANTZALI Olga	Best Scorer	16	52	15 PROL BRUNA Lucia

LEGEND

(C) Team Captain      n Starting line-up where n= starting pos      L Substitute Libero      nn Substitute where nn = shirt number  
Atts Attempts      L Libero      MB Middle Blocker      No. Shirt Number  
Opp. Opponent      OS Opposite Spiker      Pos Playing Position      Pts Points scored  
S Setter      WS Wing Spiker



SAT 2 JUL 2022

Start Time 10:00 - End Time 11:27

Match Duration 1h27

Spectators 800

**Results**
**P2**
**SRB vs TUR**  
**0 3**

Team	Sets	1	2	3	Total
SRB	0	21	14	22	57
TUR	3	25	25	25	75
	<b>Playing Time</b>	26min	23min	32min	1h21

First Referee: Zied RIDENE (TUN)

Second Referee: Ksenija JURKOVIC (CRO)

**SRB - Serbia**

No.	Name	Pos.	1	2	3	4	5	Pts
1	TAUBNER Tara	L						
2	TISMA Andrea	S	30		14			
3	OSMAJIC Minja	MB	3	1				2
4	GOCANIN Bojana	L	L	L	L			
10	CVETKOVIC Jovana	WS		18	15			
11	KURTAGIC Hena	MB		3	3			4
12	MALESEVIC Ana	MB	6	4	6			4
14	SAVIC Vanja	WS	4	2	4			11
15	KOCKAREVIC Isidora	WS	5	3	5			5
18	TICA Branka	WS	2	6	2			17
21	IVANOVIC Vanja	WS		15	30			
30	PEROVIC Rada (C)	S	1	5	1			

**Coach**

BORICIC Marijana

**Assistant Coach** JELESIC Milan / KOVACEVIC Dusan /

**TUR - Turkiye**

No.	Name	Pos.	1	2	3	4	5	Pts
1	YILMAZ Melis	L	L	L	L			
2	AYDIN Ilkin	WS	1	2	1			12
3	ARICI Emine	MB						
5	AKYALDIZ Ezgi	WS	18		2			6
8	UNAL Buse	S	6	1	6			
9	KILIC Aslihan	S			8			3
10	AKYOL Aycin	MB	5	6	5			10
11	KAYACAN SONSIRMA Buse (C)	L	L	L	L			
17	YUZGENC Tutku Burcu	OS	3	4	19			3
18	YILDIRIM Yasemin	MB	2	3	2			8
19	CEBECIOGLU Derya	WS		17	3			2
20	ERKEK Yaprak	WS	4	5	4			10

**Coach**

ALPER Hamurcu

**Assistant Coach** CANER Atasever / SIBEL Kahyalioglu

**TEAM AND PLAYER PERFORMANCES**

Won	Total Atts	No.	Name	Scoring Skills	Won	Total Atts	No.	Name
37	85	Total	Team	Spike	35	77	Total	Team
14	22	18	TICA Branka		10	17	2	AYDIN Ilkin
11	27	14	SAVIC Vanja		7	19	20	ERKEK Yaprak
4	11	15	KOCKAREVIC Isidora		6	11	10	AKYOL Aycin
4	32	Total	Team	Block	11	37	Total	Team
2	3	18	TICA Branka		3	5	20	ERKEK Yaprak
1	5	11	KURTAGIC Hena		3	10	18	YILDIRIM Yasemin
1	10	12	MALESEVIC Ana		2	9	10	AKYOL Aycin
2	60	Total	Team	Serve	8	72	Total	Team
1	11	15	KOCKAREVIC Isidora		3	7	9	KILIC Aslihan
1	12	18	TICA Branka		3	9	18	YILDIRIM Yasemin
					2	12	10	AKYOL Aycin
14		Total	Team	Opp. Error	21		Total	Team
57	177	Total	Team	Total	75	186	Total	Team
17	37	18	TICA Branka	Best Scorer	12	27	2	AYDIN Ilkin

**LEGEND**

(C) Team Captain

n Starting line-up where n= starting pos

L Substitute Libero

nn Substitute where nn = shirt number

Atts Attempts

L Libero

MB Middle Blocker

No. Shirt Number

Opp. Opponent

OS Opposite Spiker

Pos Playing Position

Pts Points scored

S Setter

WS Wing Spiker

-



SAT 2 JUL 2022

Start Time 13:00 - End Time 14:23

Match Duration 1h23

Spectators 2500

Results

P2

ITA vs ESP  
3 0

Team	Sets	1	2	3	Total
ITA	3	25	25	25	75
ESP	0	19	19	22	60
	Playing Time	24min	26min	26min	1h16

First Referee: Moshira MOHAMED (EGY)

Second Referee: Eirini MOULA (GRE)

ITA - Italy								
No.	Name	Pos.	1	2	3	4	5	Pts
2	BOSIO Francesca	S	6	1	6			1
13	BATTISTONI Ilaria	S	28	28				
16	D'ODORICO Sofia	WS	1	2	1			12
19	SQUARCINI Federica	MB	5	6	5			14
20	PANETONI Sara	L	L	L	L			
23	PERINELLI Elena (C)	WS	4	5	4			10
24	MAZZARO Alessia	MB	2	3	2			13
27	CAGNIN Emma	WS						
28	DIOP Bintou	OS	3	4	3			14
29	FROSINI Giorgia	OS	2	2				1
36	NWAKALOR Linda Nkiruka	MB						

ESP - Spain								
No.	Name	Pos.	1	2	3	4	5	Pts
5	VILLASANTE COSTA Laura	OS		9				2
6	RODRIGUEZ VILLANUEVA Elia	S		10				
7	PIZA HOMAR Margalida Victoria	L	L	L	L			
8	GARCIA CONRADO Carlota	MB	2	2	3			3
9	LAZARO CASTELLANOS Raquel	S	6	6	1			
10	CARPINTERO P.	OS	3	3	4			8
12	VARELA GOMEZ Lucia	MB	5	5	6			7
15	PROL BRUNA Lucia (C)	WS	4	4	2			12
18	JIMENEZ RUIZ Carla	MB						
21	VILLA NAVARRO Ines	WS	8		8			
22	LLORENS C.	WS	15	15	5			8
24	BRAVO CULEBRAS Denia	WS	1	1				3

**Coach** PIERAGNOLI Luca  
**Assistant Coach** SAJA Stefano / INGRATTA Matteo

**Coach** SAURIN CUTILLAS Pascual  
**Assistant Coach** GARCIA DIAZ Juan Diego / SALLERAS

TEAM AND PLAYER PERFORMANCES

Won	Total Atts	No. Name	Scoring Skills	Won	Total Atts	No. Name
48	104	Total Team	Spike	30	97	Total Team
12	25	16 D'ODORICO Sofia		9	24	15 PROL BRUNA Lucia
10	27	28 DIOP Bintou		5	10	22 LLORENS C.
9	27	23 PERINELLI Elena		5	24	10 CARPINTERO P.
12	39	Total Team	Block	12	45	Total Team
5	19	19 SQUARCINI Federica		3	6	10 CARPINTERO P.
3	7	24 MAZZARO Alessia		3	6	15 PROL BRUNA Lucia
3	7	28 DIOP Bintou		3	9	12 VARELA GOMEZ Lucia
5	73	Total Team	Serve	1	62	Total Team
2	16	24 MAZZARO Alessia		1	3	5 VILLASANTE COSTA Laura
1	10	19 SQUARCINI Federica				
1	12	28 DIOP Bintou				
10		Total Team	Opp. Error	17		Total Team
75	216	Total Team	Total	60	204	Total Team
14	41	19 SQUARCINI Federica	Best Scorer	12	38	15 PROL BRUNA Lucia

LEGEND

(C)	Team Captain	n	Starting line-up where n= starting pos	L	Substitute Libero	nn	Substitute where nn = shirt number
Atts	Attempts	L	Libero	MB	Middle Blocker	No.	Shirt Number
Opp.	Opponent	OS	Opposite Spiker	Pos	Playing Position	Pts	Points scored
S	Setter	WS	Wing Spiker				
-	-						



FRI 1 JUL 2022  
Start Time 9:30 - End Time 11:28  
Match Duration 1h58  
Spectators 300

**Results**  
**P2**

**EGY vs TUN**  
**3 1**

Team	Sets	1	2	3	4	Total
EGY	3	25	21	25	25	96
TUN	1	12	25	18	21	76
	<b>Playing Time</b>	23min	28min	29min	29min	1h49

First Referee: Ksenija JURKOVIC (CRO)

Second Referee: CORREA BENITEZ (ESP)

EGY - Egypt								
No.	Name	Pos.	1	2	3	4	5	Pts
1	ELSHAMY Aya	OS	3	3		10		9
4	MEAWAD Nada	WS	1	1	1	3		19
7	AHMED Mariam	L	L	L	L	L		
8	ABDELFAHATTAH Nahla (C)	WS	4					
10	AHMED Maya	OS		1	3	5		9
11	HANAFY Sarah	OS		4				
12	ELASKALANY Farida	MB	2	2	2	4		8
13	MAHFOUZ Laila	S		19				
15	ELELEMY Zeina	WS	4		4	6		15
19	SAYID Sohila	S	6	6	6	2		2
20	MORSY Mariam	MB	5	22	5	1		9
22	MORSHEDEY Dalia	MB		5				2

TUN - Tunisia								
No.	Name	Pos.	1	2	3	4	5	Pts
2	HAMOUDA Mouna	L	L	L	L	L		
4	GALAI Chourouk	MB	4	3	4	2		
7	AGREBI Rahma (C)	OS	6	5	6	4		7
8	OTHMANI Abir	MB	1	6	1	5		7
10	ISMAIL Eya	OS	7	4	15	15		
12	GHIZAOUI Ameni	WS	13	15		4		1
13	BOURAOUI Sirine	WS	3	2	3	1		12
14	FATNASSI Hiba	S	15		20	20		
15	KEBAIER EP HMSSI Nihel	S	2	1	2	6		2
17	JENHANI Sahar	MB	4		4			
20	ABDA Nesrine	OS	5	4	5	3		21

**Coach** MOHAMED Ahmed  
**Assistant Coach**

**Coach**  
**Assistant Coach**

**TEAM AND PLAYER PERFORMANCES**

Won	Total Atts	No. Name	Scoring Skills	Won	Total Atts	No. Name
57	129	<b>Total Team</b>	<b>Spike</b>	41	128	<b>Total Team</b>
17	44	4 MEAWAD Nada		20	58	20 ABDA Nesrine
12	20	15 ELELEMY Zeina		9	32	13 BOURAOUI Sirine
9	16	1 ELSHAMY Aya		7	24	7 AGREBI Rahma
8	47	<b>Total Team</b>	<b>Block</b>	5	51	<b>Total Team</b>
2	6	15 ELELEMY Zeina		2	10	8 OTHMANI Abir
1	8	19 SAYID Sohila		1	7	15 KEBAIER EP HMSSI Nihel
1	7	20 MORSY Mariam		1	3	20 ABDA Nesrine
8	95	<b>Total Team</b>	<b>Serve</b>	4	77	<b>Total Team</b>
3	11	10 AHMED Maya		2	14	13 BOURAOUI Sirine
2	20	12 ELASKALANY Farida		1	12	15 KEBAIER EP HMSSI Nihel
1	15	19 SAYID Sohila		1	4	12 GHIZAOUI Ameni
23		<b>Total Team</b>	<b>Opp. Error</b>	26		<b>Total Team</b>
96	271	<b>Total Team</b>	<b>Total</b>	76	256	<b>Total Team</b>
19	66	4 MEAWAD Nada	<b>Best Scorer</b>	21	70	20 ABDA Nesrine

**LEGEND**

(C)	Team Captain	n	Starting line-up where n= starting pos	L	Substitute Libero	nn	Substitute where nn = shirt number
Atts	Attempts	L	Libero	MB	Middle Blocker	No.	Shirt Number
Opp.	Opponent	OS	Opposite Spiker	Pos	Playing Position	Pts	Points scored
S	Setter	WS	Wing Spiker				
-	-						



FRI 1 JUL 2022  
Start Time 12:30 - End Time 14:38  
Match Duration 2h8  
Spectators 400

**Results**  
**P2**

**CRO vs GRE**  
**1 3**

Team	Sets	1	2	3	4	Total
CRO	1	25	22	23	19	89
GRE	3	20	25	25	25	95
	<b>Playing Time</b>	29min	29min	31min	30min	1h59

First Referee: Dejan ROGIC (SRB)

Second Referee: Ehsan REJAEYAN (FRA)

CRO - Croatia								
No.	Name	Pos.	1	2	3	4	5	Pts
2	GRBAVICA Mika	OS	2	3	2	2		17
4	BUTIGAN Bozana	MB	6	1	6	6		14
5	BOZICEVIC Nikolina	WS				12		1
6	PERIC Klara	S						
7	MILOS Laura	WS	5	6	5			4
8	POPIC Astrid	MB						
11	DUMANCIC Beta	MB						
12	MARKOVIC Josipa	WS	4	5	4	4		13
14	SAMADAN Martina (C)	MB	3	4	3	3		13
16	DEAK Lea	S	1	2	1	1		2
19	STIMAC Izabela	L	L	L	L	L		
20	TOMIC Natalia	WS			7	5		6

GRE - Greece								
No.	Name	Pos.	1	2	3	4	5	Pts
1	CHATZIEFSTRATIADOU Eirini	MB						
4	KONSTANTINIDOU Lamprini	S	1	1	1	1		6
5	NIKOLGIANNI Asimina	WS	5	5	5	5		23
8	ILIOPOULOU Elisavet	S	16		21			
9	STRANTZALI Olga (C)	WS	21	2	2	2		16
13	XANTHOPOULOU Maria Aikaterini	L	L	L	L	L		
16	GENITSARIDI Maria	OS	4	4	4	23		3
19	SPANOU Anna Maria	WS	4					
21	KYPARISSI Stamatia	WS	2	16	4	4		5
22	KLEPKOU Maria	WS	5	5				
23	TERZOGLU Kyriaki	MB	3	3	3	3		10
24	TSIOGKA Andromachi	MB	6	6	6	6		9

**Coach** AKBAS Ferhat  
**Assistant Coach** MATELA Piotr Jerzy

**Coach** ABBONDANZA Marcello  
**Assistant Coach** BOUTSOURIS Nikolaos

**TEAM AND PLAYER PERFORMANCES**

Won	Total Atts	No.	Name	Scoring Skills	Won	Total Atts	No.	Name
50	138	Total	Team	Spike	52	116	Total	Team
14	44	2	GRBAVICA Mika		19	35	5	NIKOLGIANNI Asimina
11	25	12	MARKOVIC Josipa		16	29	9	STRANTZALI Olga
10	22	14	SAMADAN Martina		5	10	24	TSIOGKA Andromachi
7	53	Total	Team	Block	12	59	Total	Team
4	11	4	BUTIGAN Bozana		5	15	23	TERZOGLU Kyriaki
2	14	14	SAMADAN Martina		2	4	5	NIKOLGIANNI Asimina
1	10	12	MARKOVIC Josipa		2	11	24	TSIOGKA Andromachi
13	90	Total	Team	Serve	8	94	Total	Team
3	11	4	BUTIGAN Bozana		2	13	5	NIKOLGIANNI Asimina
3	22	2	GRBAVICA Mika		2	11	24	TSIOGKA Andromachi
2	9	20	TOMIC Natalia		1	7	16	GENITSARIDI Maria
19		Total	Team	Opp. Error	23		Total	Team
89	281	Total	Team	Total	95	269	Total	Team
17	73	2	GRBAVICA Mika	Best Scorer	23	52	5	NIKOLGIANNI Asimina

**LEGEND**

(C) Team Captain      n Starting line-up where n= starting pos      L Substitute Libero      nn Substitute where nn = shirt number  
Atts Attempts      L Libero      MB Middle Blocker      No. Shirt Number  
Opp. Opponent      OS Opposite Spiker      Pos Playing Position      Pts Points scored  
S Setter      WS Wing Spiker



MON 4 JUL 2022

Start Time 16:30 - End Time 18:47

Match Duration 2h17

Spectators 3000

**Results**
**P2**
**TUR vs ITA**
**1 3**

Team	Sets	1	2	3	4	Total
TUR	1	24	20	25	22	91
ITA	3	26	25	22	25	98
	Playing Time	36min	31min	33min	28min	2h8

First Referee: EYIKE M. (CMR)

Second Referee: Ksenija JURKOVIC (CRO)

**TUR - Turkiye**

No.	Name	Pos.	1	2	3	4	5	Pts
1	YILMAZ Melis	L	L	L	L	L		
2	AYDIN Ilkin	WS	2	2	4	5		15
3	ARICI Emine	MB						
5	AKYALDIZ Ezgi	WS	2	20		20		2
8	UNAL Buse	S	1	1		19		1
9	KILIC Aslihan	S	17	8	6	1		2
10	AKYOL Aycin	MB	6	6	5	6		13
11	KAYACAN SONSIRMA Buse (C)	L	L	L	L	L		
17	YUZGENC Tutku Burcu	OS	4	4		9		2
18	YILDIRIM Yasemin	MB	3	3	2	3		10
19	CEBECIOGLU Derya	WS	8	17	3	4		11
20	ERKEK Yaprak	WS	5	5	1	2		3

**Coach**

ALPER Hamurcu

**Assistant Coach** CANER Atasever / SIBEL Kahyalioglu

**ITA - Italy**

No.	Name	Pos.	1	2	3	4	5	Pts
2	BOSIO Francesca	S	6	6	6	6		3
13	BATTISTONI Ilaria	S			28			
16	D'ODORICO Sofia	WS	1	1	1	1		15
19	SQUARCINI Federica	MB	5	5	5	5		13
20	PANETONI Sara	L	L	L	L	L		
23	PERINELLI Elena (C)	WS	4	4	4	4		17
24	MAZZARO Alessia	MB	2	2	2	2		6
27	CAGNIN Emma	WS		23	23			3
28	DIOP Bintou	OS	3	3	3	3		12
29	FROSINI Giorgia	OS			2	28		4
36	NWAKALOR Linda Nkiruka	MB						

**Coach**

PIERAGNOLI Luca

**Assistant Coach** SAJA Stefano / INGRATTA Matteo

**TEAM AND PLAYER PERFORMANCES**

Won	Total Atts	No.	Name	Scoring Skills	Won	Total Atts	No.	Name
44	130	Total	Team	Spike	61	145	Total	Team
13	31	2	AYDIN Ilkin		15	28	23	PERINELLI Elena
11	28	19	CEBECIOGLU Derya		15	38	16	D'ODORICO Sofia
9	22	10	AKYOL Aycin		10	18	19	SQUARCINI Federica
12	55	Total	Team	Block	7	50	Total	Team
4	14	18	YILDIRIM Yasemin		2	5	2	BOSIO Francesca
2	17	10	AKYOL Aycin		2	7	28	DIOP Bintou
2	8	2	AYDIN Ilkin		1	12	19	SQUARCINI Federica
3	92	Total	Team	Serve	5	97	Total	Team
2	13	10	AKYOL Aycin		2	19	19	SQUARCINI Federica
1	17	9	KILIC Aslihan		1	17	23	PERINELLI Elena
					1	13	2	BOSIO Francesca
32		Total	Team	Opp. Error	25		Total	Team
91	277	Total	Team	Total	98	292	Total	Team

15	54	2	AYDIN Ilkin	Best Scorer	17	49	23	PERINELLI Elena
----	----	---	-------------	-------------	----	----	----	-----------------

**LEGEND**

(C) Team Captain

Atts Attempts

Opp. Opponent

S Setter

-

n Starting line-up where n= starting pos

L Libero

OS Opposite Spiker

WS Wing Spiker

L Substitute Libero

MB Middle Blocker

Pos Playing Position

nn Substitute where nn = shirt number

No. Shirt Number

Pts Points scored



MON 4 JUL 2022

Start Time 9:28 - End Time 11:34

Match Duration 2h6

Spectators 400

## Results

P2

SRB vs ESP  
3 2

Team	Sets	1	2	3	4	5	Total
SRB	3	16	25	20	25	15	101
ESP	2	25	18	25	16	10	94
	Playing Time	22min	23min	27min	24min	15min	1h51

First Referee: Moshira MOHAMED (EGY)

Second Referee: VERRASCINA A. (ITA)

SRB - Serbia								
No.	Name	Pos.	1	2	3	4	5	Pts
1	TAUBNER Tara	L						
2	TISMA Andrea	S			18			
3	OSMAJIC Minja	MB	3	2	3	2	2	12
4	GOCANIN Bojana	L	L	L	L	L	L	
10	CVETKOVIC Jovana	WS	15	4	5	4	4	11
11	KURTAGIC Hena	MB						
12	MALESEVIC Ana	MB	6	5	6	5	5	18
14	SAVIC Vanja	WS	4		30			2
15	KOCKAREVIC Isidora	WS	5	1	2	1	1	9
18	TICA Branka	WS	2	3	4	3	3	16
21	IVANOVIC Vanja	WS						
30	PEROVIC Rada (C)	S	1	6	1	6	6	7

**Coach** BORICIC Marijana  
**Assistant Coach** JELESIC Milan / KOVACEVIC Dusan /

ESP - Spain								
No.	Name	Pos.	1	2	3	4	5	Pts
5	VILLASANTE COSTA Laura	OS						
6	RODRIGUEZ VILLANUEVA Elia	S		10		10		
7	PIZA HOMAR Margalida Victoria	L	L	L	L	L	L	
8	GARCIA CONRADO Carlota	MB	2	2	2	2	2	8
9	LAZARO CASTELLANOS Raquel	S	6	6	6	6	6	1
10	CARPINTERO P.	OS	3	3	3	3	3	17
12	VARELA GOMEZ Lucia	MB	5	5	5	5	5	12
15	PROL BRUNA Lucia (C)	WS	1	1	1	1	4	15
18	JIMENEZ RUIZ Carla	MB						
21	VILLA NAVARRO Ines	WS	8	9	8	9	8	
22	LLORENS C.	WS		24		24		3
24	BRAVO CULEBRAS Denia	WS	4	4	4	4	1	10

**Coach** SAURIN CUTILLAS Pascual  
**Assistant Coach** GARCIA DIAZ Juan Diego / SALLERAS

## TEAM AND PLAYER PERFORMANCES

Won	Total Atts	No. Name	Scoring Skills	Won	Total Atts	No. Name
55	140	Total Team	Spike	55	152	Total Team
14	46	18 TICA Branka		16	45	10 CARPINTERO P.
11	20	12 MALESEVIC Ana		14	46	15 PROL BRUNA Lucia
10	16	3 OSMAJIC Minja		9	27	24 BRAVO CULEBRAS Denia
10	65	Total Team	Block	9	51	Total Team
5	20	12 MALESEVIC Ana		4	11	12 VARELA GOMEZ Lucia
2	16	3 OSMAJIC Minja		1	7	8 GARCIA CONRADO Carlota
1	6	10 CVETKOVIC Jovana		1	7	9 LAZARO CASTELLANOS Raquel
10	100	Total Team	Serve	2	95	Total Team
4	21	10 CVETKOVIC Jovana		1	13	24 BRAVO CULEBRAS Denia
2	14	12 MALESEVIC Ana		1	12	12 VARELA GOMEZ Lucia
2	21	30 PEROVIC Rada				
26		Total Team	Opp. Error	28		Total Team
101	305	Total Team	Total	94	298	Total Team

18	54	12 MALESEVIC Ana	Best Scorer	17	68	10 CARPINTERO P.
----	----	------------------	-------------	----	----	------------------

## LEGEND

(C)	Team Captain	n	Starting line-up where n= starting pos	L	Substitute Libero	nn	Substitute where nn = shirt number
Atts	Attempts	L	Libero	MB	Middle Blocker	No.	Shirt Number
Opp.	Opponent	OS	Opposite Spiker	Pos	Playing Position	Pts	Points scored
S	Setter	WS	Wing Spiker				
-	-						





SAT 2 JUL 2022  
Start Time 12:30 - End Time 14:23  
Match Duration 1h53  
Spectators 150

## Results

P2

### EGY vs GRE

Team	Sets	1	2	3	4	Total
EGY	1	25	16	17	21	79
GRE	3	17	25	25	25	92
	<b>Playing Time</b>	25min	24min	27min	28min	1h44

First Referee: CORREA BENITEZ (ESP)

Second Referee: Nacer ZEBAR (ALG)

#### EGY - Egypt

No.	Name	Pos.	1	2	3	4	5	Pts
1	ELSHAMY Aya	OS	5	4	19	19		8
4	MEAWAD Nada	WS	3	2	3	15		8
7	AHMED Mariam	L	L	L	L	L		
8	ABDELFAHATTAH Nahla (C)	WS						
10	AHMED Maya	OS	19	19	5	4		9
11	HANAFY Sarah	OS	6	5	4	5		2
12	ELASKALANY Farida	MB	4	3	4	3		8
13	MAHFOUZ Laila	S		1	10			
15	ELELEMY Zeina	WS		11	6	2		5
19	SAYID Sohila	S	2	1	2	1		1
20	MORSY Mariam	MB	1	6	1	6		17
22	MORSHEDEY Dalia	MB						

**Coach** MOHAMED Ahmed  
**Assistant Coach**

#### GRE - Greece

No.	Name	Pos.	1	2	3	4	5	Pts
1	CHATZIEFSTRATIADOU Eirini	MB	24				24	
4	KONSTANTINIDOU Lamprini	S	1	1		1	1	4
5	NIKOLOGIANNI Asimina	WS	5	5				3
8	ILIOPOULOU Elisavet	S	16					
9	STRANTZALI Olga (C)	WS	4	4	4	4		22
13	XANTHOPOULOU Maria Aikaterini	L	L	L	L	L		
16	GENITSARIDI Maria	OS	4		21			2
19	SPANOU Anna Maria	WS		5		5		12
21	KYPARISSI Stamatia	WS	2	2	2	2		12
22	KLEPKOU Maria	WS		21	19	21		4
23	TERZOGLOU Kyriaki	MB	3	3	3	3		10
24	TSIOGKA Andromachi	MB	6	6	6	6		6

**Coach** ABBONDANZA Marcello  
**Assistant Coach** BOUTSOURIS Nikolaos / ALPI Daniele

#### TEAM AND PLAYER PERFORMANCES

Won	Total Atts	No. Name	Scoring Skills	Won	Total Atts	No. Name
43	122	<b>Total Team</b>	<b>Spike</b>	53	129	<b>Total Team</b>
13	20	20 MORSY Mariam		19	42	9 STRANTZALI Olga
8	22	10 AHMED Maya		11	24	19 SPANOU Anna Maria
6	16	1 ELSHAMY Aya		9	25	21 KYPARISSI Stamatia
9	42	<b>Total Team</b>	<b>Block</b>	12	38	<b>Total Team</b>
4	10	20 MORSY Mariam		4	13	24 TSIOGKA Andromachi
1	4	10 AHMED Maya		3	6	21 KYPARISSI Stamatia
1	5	1 ELSHAMY Aya		2	3	4 KONSTANTINIDOU Lamprini
6	80	<b>Total Team</b>	<b>Serve</b>	10	91	<b>Total Team</b>
2	12	4 MEAWAD Nada		3	19	23 TERZOGLOU Kyriaki
2	23	12 ELASKALANY Farida		2	17	4 KONSTANTINIDOU Lamprini
1	13	19 SAYID Sohila		2	10	9 STRANTZALI Olga
21		<b>Total Team</b>	<b>Opp. Error</b>	17		<b>Total Team</b>
79	244	<b>Total Team</b>	<b>Total</b>	92	258	<b>Total Team</b>
17	39	20 MORSY Mariam	<b>Best Scorer</b>	22	56	9 STRANTZALI Olga

#### LEGEND

(C)	Team Captain	n	Starting line-up where n= starting pos	L	Substitute Libero	nn	Substitute where nn = shirt number
Atts	Attempts	L	Libero	MB	Middle Blocker	No.	Shirt Number
Opp.	Opponent	OS	Opposite Spiker	Pos	Playing Position	Pts	Points scored
S	Setter	WS	Wing Spiker				
-	-						



SAT 2 JUL 2022  
Start Time 9:30 - End Time 10:47  
Match Duration 1h17  
Spectators 100

Results  
P2

TUN vs CRO  
0 3

Team	Sets	1	2	3	Total
TUN	0	19	12	20	51
CRO	3	25	25	25	75
	Playing Time	24min	21min	26min	1h11

First Referee: Ehsan REJAEYAN (FRA)

Second Referee: VERRASCINA A. (ITA)

TUN - Tunisia								
No.	Name	Pos.	1	2	3	4	5	Pts
2	HAMOUDA Mouna	L	L	L	L			
4	GALAI Chourouk	MB	3	4	3			7
7	AGREBI Rahma (C)	OS	5		5			6
8	OTHMANI Abir	MB	6		6			
10	ISMAIL Eya	OS	15	6				3
12	GHIZAOUI Ameni	WS		13				
13	BOURAOUI Sirine	WS	2	3	2			6
14	FATNASSI Hiba	S		15				
15	KEBAIER EP HMSSI Nihel	S	1	2	1			3
17	JENHANI Sahar	MB		1				3
20	ABDA Nesrine	OS	4	5	4			7

CRO - Croatia								
No.	Name	Pos.	1	2	3	4	5	Pts
2	GRBAVICA Mika	OS	2	2	2			10
4	BUTIGAN Bozana	MB	6	6	6			10
5	BOZICEVIC Nikolina	L	L	L	L			
6	PERIC Klara	S						
7	MILOS Laura	WS	5	5	5			11
8	POPIC Astrid	MB						
11	DUMANCIC Beta	MB		14				
12	MARKOVIC Josipa	WS	4	4	4			8
14	SAMADAN Martina (C)	MB	3	3	3			8
16	DEAK Lea	S	1	1	1			
19	STIMAC Izabela	L						
20	TOMIC Natalia	WS		12				2

**Coach**  
**Assistant Coach**

**Coach** AKBAS Ferhat  
**Assistant Coach** MATELA Piotr Jerzy / MICHALSKI Krzysztof

TEAM AND PLAYER PERFORMANCES

Won	Total Atts	No.	Name	Scoring Skills	Won	Total Atts	No.	Name
21	79	Total	Team	Spike	36	76	Total	Team
5	20	13	BOURAOUI Sirine		9	17	2	GRBAVICA Mika
5	15	7	AGREBI Rahma		7	18	12	MARKOVIC Josipa
5	27	20	ABDA Nesrine		7	18	7	MILOS Laura
6	28	Total	Team	Block	10	29	Total	Team
3	7	4	GALAI Chourouk		4	7	4	BUTIGAN Bozana
2	5	20	ABDA Nesrine		3	6	7	MILOS Laura
1	3	7	AGREBI Rahma		1	4	12	MARKOVIC Josipa
8	53	Total	Team	Serve	3	73	Total	Team
3	14	15	KEBAIER EP HMSSI Nihel		2	8	14	SAMADAN Martina
2	3	17	JENHANI Sahar		1	15	7	MILOS Laura
2	9	4	GALAI Chourouk					
16		Total	Team	Opp. Error	26		Total	Team
51	160	Total	Team	Total	75	178	Total	Team
7	20	4	GALAI Chourouk	Best Scorer	11	39	7	MILOS Laura

LEGEND

(C) Team Captain      n Starting line-up where n= starting pos      L Substitute Libero      nn Substitute where nn = shirt number  
Atts Attempts      L Libero      MB Middle Blocker      No. Shirt Number  
Opp. Opponent      OS Opposite Spiker      Pos Playing Position      Pts Points scored  
S Setter      WS Wing Spiker



## Top Player Ranking by Skill

As of MON 4 JUL 2022 at 22:18

### Best Scores

Rk	NO.	Name	CTRY	Pos.	Spikes	Blocks	Serve	Total
1	9	STRANTZALI Olga	GRE	WS	75	8	9	92
2	18	TICA Branka	SRB	WS	76	6	4	86
3	20	ABDA Nesrine	TUN	OS	64	16	4	84
4	28	DIOP Binto	ITA	OS	60	8	7	75
5	4	MEAWAD Nada	EGY	WS	63	3	6	72
5	10	CARPINTERO GOMEZ Paula Del Carmen	ESP	OS	64	6	2	72
7	4	BUTIGAN Bozana	CRO	MB	44	22	5	71
7	2	AYDIN Ilkin	TUR	WS	61	7	3	71
9	2	GRBAVICA Mika	CRO	OS	61	2	5	68
9	15	PROL BRUNA Lucia	ESP	WS	59	9		68
11	19	SQUARCINI Federica	ITA	MB	44	13	10	67
12	20	MORSY Mariam	EGY	MB	47	15		62
12	12	VARELA GOMEZ Lucia	ESP	MB	34	20	8	62
14	20	ERKEK Yaprak	TUR	WS	44	9	7	60
14	10	AKYOL Aycin	TUR	MB	41	14	5	60
16	14	SAMADAN Martina	CRO	MB	43	10	6	59
16	10	AHMED Maya	EGY	OS	46	7	6	59
16	5	NIKOLGIANNI Asimina	GRE	WS	51	3	5	59
19	3	OSMAJIC Minja	SRB	MB	35	11	11	57
20	12	ELASKALANY Farida	EGY	MB	37	13	5	55
21	16	D'ODORICO Sofia	ITA	WS	49	1	4	54
21	24	MAZZARO Alessia	ITA	MB	36	9	9	54
23	13	BOURAOUI Sirine	TUN	WS	47	1	5	53
24	15	ELELEMY Zeina	EGY	WS	46	5	1	52
24	17	YUZGENC Tutku Burcu	TUR	OS	43	7	2	52
26	23	PERINELLI Elena	ITA	WS	45	1	5	51
26	7	AGREBI Rahma	TUN	OS	48	2	1	51
28	14	SAVIC Vanja	SRB	WS	38	7	5	50
29	7	MILOS Laura	CRO	WS	36	8	5	49
29	21	KYPARISSI Stamatia	GRE	WS	38	9	2	49
31	12	MARKOVIC Josipa	CRO	WS	35	4	3	42
31	98	HAEWEGENE Sabine	FRA	WS	37	2	3	42
33	15	KOCKAREVIC Isidora	SRB	WS	33	4	4	41
34	18	YILDIRIM Yasemin	TUR	MB	19	15	6	40
35	24	BRAVO CULEBRAS Denia	ESP	WS	31	4	2	37
36	7	STOJANOVA Tamara	MKD	WS	32		3	35
36	19	CEBECIOGLU Derya	TUR	WS	31	4		35
38	23	TERZOGLU Kyriaki	GRE	MB	15	14	5	34
38	16	GENITSARIDI Maria	GRE	OS	29	1	4	34
40	8	GARCIA CONRADO Carlota	ESP	MB	23	7	2	32
<b>Tournament Totals</b>					2282	446	3040	312



## Top Player Ranking by Skill

As of MON 4 JUL 2022 at 22:18

### Best Spikes

Scoring Spikes	Rk	No.	Name	CTRY	Pos.	Spikes	Faults	Shots	Total Attempts	Eff.%
	1	3	OSMAJIC Minja	SRB	MB	35	5	16	56	53.57
	2	14	SAMADAN Martina	CRO	MB	43	6	27	76	48.68
	2	19	SQUARCINI Federica	ITA	MB	44	7	25	76	48.68
	4	10	AKYOL Aycin	TUR	MB	41	5	30	76	47.37
	5	24	MAZZARO Alessia	ITA	MB	36	6	22	64	46.88
	6	2	BOSIO Francesca	ITA	S	7		8	15	46.67
	7	4	KONSTANTINIDOU Lamprini	GRE	S	15	2	11	28	46.43
	8	3	STOJANOVSKA Simona	MKD	MB	12	1	11	24	45.83
	9	8	GARCIA CONRADO Carlota	ESP	MB	23	5	16	44	40.91
	10	19	SPANOU Anna Maria	GRE	WS	27	3	30	60	40.00
Limit 15.00%	<b>Tournament Totals</b>					2282	987	2620	5889	21.99

### BEST BLOCKERS

Scoring Block	Rk	No.	Name	NOC	Pos.	Kill Blocks	Faults	Rebounds	Total Attempts	Avg by Set
	1	23	OLINGA ANDELA Leandra	FRA	MB	6	5	7	18	1.20
	2	4	BUTIGAN Bozana	CRO	MB	22	20	22	64	1.10
	3	12	VARELA GOMEZ Lucia	ESP	MB	20	18	17	55	0.95
	4	20	ABDA Nesrine	TUN	OS	16	11	8	35	0.80
	5	23	TERZOGLU Kyriaki	GRE	MB	14	12	26	52	0.78
	6	18	YILDIRIM Yasemin	TUR	MB	15	21	24	60	0.75
	7	20	MORSY Mariam	EGY	MB	15	19	15	49	0.68
	8	10	AKYOL Aycin	TUR	MB	14	32	27	73	0.67
	9	19	SQUARCINI Federica	ITA	MB	13	31	26	70	0.65
	10	11	KURTAGIC Hena	SRB	MB	9	8	16	33	0.64
	<b>Tournament Totals</b>					446	870	924	2240	0.20

### Best Servers

Scoring Service	Rk	No.	Name	CTRY	Pos.	Aces	Faults	Serve Hits	Total Attempts	Avg. by Set
	1	10	JONUZI Erjona	MKD	S	9		37	46	0.90
	2	3	OSMAJIC Minja	SRB	MB	11	14	51	76	0.55
	3	10	SOUALMI Melissa	ALG	OS	2	1	10	13	0.50
	3	19	SQUARCINI Federica	ITA	MB	10	15	45	70	0.50
	3	14	DIKOVA Mila	MKD	OS	5	3	24	32	0.50
	6	4	KONSTANTINIDOU Lamprini	GRE	S	9	8	83	100	0.45
	6	9	STRANTZALI Olga	GRE	WS	9	7	64	80	0.45
	6	24	MAZZARO Alessia	ITA	MB	9	3	76	88	0.45
	9	20	TOMIC Natalia	CRO	WS	3	2	12	17	0.43
	9	30	PEROVIC Rada	SRB	S	9	12	81	102	0.43
	<b>Tournament Totals</b>					312	445	4165	3408	0.07



## Top Player Ranking by Skill

As of MON 4 JUL 2022 at 22:18

### BEST DIGGERS

Non-Scoring Dig	Rk	No.	Name	CTRY	Pos.	Digs	Faults	Receptions	Total Attempts	Avg. by Set
	1	20	PANETONI Sara	ITA	L	6	10	65	81	1.00
	2	4	GOCANIN Bojana	SRB	L	3	14	46	63	0.60
	3	13	XANTHOPOULOU Maria Aikaterini	GRE	L	3	2	57	62	0.50
	4	7	PIZA HOMAR Margalida Victoria	ESP	L	2	20	48	70	0.33
	5	5	BOZICEVIC Nikolina	CRO	L	2	2	9	13	0.29
	6	18	TICA Branka	SRB	WS	4	9	24	37	0.19
	7	11	HANAFY Sarah	EGY	OS	2	2	10	14	0.18
<b>Tournament Totals</b>						70	459	1742	2271	0.03

### Best Setters

Non-Scoring Set	Rk	No.	Name	CTRY	Pos.	Running Sets	Faults	Still Sets	Total Attempts	Avg. by Set
										
<b>Tournament Totals</b>							79	1	80	0.00

### Best Receivers

Non-Scoring Reception	Rk	No.	Name	CTRY	Pos.	Excellents	Faults	Serve Receptions	Total Attempts	Succ. %
	1	20	PANETONI Sara	ITA	L	44	1	28	73	60.27
	2	5	AKYALDIZ Ezgi	TUR	WS	17	1	13	31	54.84
	3	19	STIMAC Izabela	CRO	L	49	5	36	90	54.44
	4	11	KAYACAN SONSIRMA Buse	TUR	L	35	1	29	65	53.85
	5	10	CVETKOVIC Jovana	SRB	WS	43	4	35	82	52.44
	6	5	BOZICEVIC Nikolina	CRO	L	15	2	12	29	51.72
	7	13	XANTHOPOULOU Maria Aikaterini	GRE	L	47	7	37	91	51.65
	8	4	GOCANIN Bojana	SRB	L	33	4	27	64	51.56
	9	18	TICA Branka	SRB	WS	60	4	61	125	48.00
	10	20	ERKEK Yaprak	TUR	WS	58	6	57	121	47.93
<b>Tournament Totals</b>						1423	305	1970	3698	38.48

#### LEGEND

<b>Avg</b> Average per Game	<b>Eff%</b> Efficiency	<b>L</b> Libero	<b>MB</b> Middle Blocker
<b>NO.</b> Shirt Number	<b>OS</b> Opposite Striker	<b>Pos.</b> Playing Position	<b>S</b> Setter
<b>Succ</b> Success%	<b>WS</b> Wing Spike	-	-



## Team Ranking by Skill

As of MON 4 JUL 2022 at 22:18

Scoring Spike	Rk	Team	Spikes	Faults	Shots	Total Attempts	Eff. %
	1	GRE - Greece	273	80	283	636	30.35
	2	TUR - Turkiye	262	81	255	598	30.27
	3	ITA - Italy	286	106	242	634	28.39
	4	CRO - Croatia	234	102	249	585	22.56
	5	SRB - Serbia	248	109	264	621	22.38
	6	ESP - Spain	238	96	324	658	21.58
	7	EGY - Egypt	279	123	323	725	21.52
	8	FRA - France	99	46	115	260	20.38
	9	TUN - Tunisia	186	107	307	600	13.17
	10	MKD - North Macedonia	93	70	133	296	7.77
	11	ALG - Algeria	84	67	125	276	6.16
<b>Tournament Totals</b>			2282	987	2620	5889	21.99

Scoring Block	Rk	Team	Kill Blocks	Faults	Rebounds	Total Attempts	Avg. by Set
	1	TUR - Turkiye	65	103	112	280	3.10
	2	ESP - Spain	56	94	96	246	2.67
	3	GRE - Greece	51	83	109	243	2.55
	4	CRO - Croatia	50	97	93	240	2.50
	5	SRB - Serbia	51	93	97	241	2.43
	6	EGY - Egypt	52	115	117	284	2.26
	7	ITA - Italy	44	93	91	228	2.20
	8	FRA - France	18	36	49	103	2.00
	9	TUN - Tunisia	35	97	98	230	1.75
	10	MKD - North Macedonia	17	26	32	75	1.70
	11	ALG - Algeria	7	33	30	70	0.78
<b>Tournament Totals</b>			446	870	924	2240	0.20

Scoring Service	Rk	Team	Aces	Faults	Serve Hits	Total Attempts	Avg. by Set
	1	ITA - Italy	47	59	375	481	2.35
	2	MKD - North Macedonia	23	21	153	197	2.30
	3	SRB - Serbia	45	60	343	448	2.14
	4	GRE - Greece	41	48	383	472	2.05
	5	TUR - Turkiye	34	43	424	501	1.62
	6	CRO - Croatia	32	41	352	425	1.60
	7	TUN - Tunisia	29	38	306	373	1.45
	8	FRA - France	13	16	159	188	1.44
	9	EGY - Egypt	27	42	423	492	1.17
	10	ESP - Spain	18	53	368	439	0.86
	11	ALG - Algeria	3	24	122	149	0.33
<b>Tournament Totals</b>			312	445	3408	4165	0.07



## Team Ranking by Skill

As of MON 4 JUL 2022 at 22:18

Non-Scoring Dig	Rk	Team	Aces	Faults	Serve	Total Attempts	Avg. by Set
	1	GRE - Greece	12	39	213	264	0.60
	2	SRB - Serbia	11	48	167	226	0.52
	3	ITA - Italy	9	37	188	234	0.45
	4	ESP - Spain	9	63	178	250	0.43
	4	TUR - Turkiye	9	48	177	234	0.43
	6	EGY - Egypt	9	49	252	310	0.39
	7	CRO - Croatia	7	46	148	201	0.35
	8	TUN - Tunisia	4	57	188	249	0.20
	9	ALG - Algeria		25	71	96	0.00
	9	FRA - France		22	87	109	0.00
	9	MKD - North Macedonia		25	73	98	0.00
<b>Tournament Totals</b>			70	459	1742	2271	0.03

Non-Scoring Set	Rk	Team	Running Sets	Faults	Still Sets	Total Attempts	Avg. by Set	
	1	ALG - Algeria		9		9	0.00	
	1	CRO - Croatia		8		8	0.00	
	1	EGY - Egypt		13	1	14	0.00	
	1	ESP - Spain		11		11	0.00	
	1	FRA - France		1		1	0.00	
	1	GRE - Greece		11		11	0.00	
	1	ITA - Italy		7		7	0.00	
	1	MKD - North Macedonia		3		3	0.00	
	1	SRB - Serbia		7		7	0.00	
	1	TUN - Tunisia		8		8	0.00	
	1	TUR - Turkiye		1		1	0.00	
	<b>Tournament Totals</b>				79	1	80	0.00

Non-Scoring Reception	Rk	Team	Excellents	Faults	Serve Reception	Total Attempts	Succ. %
	1	SRB - Serbia	189	19	180	388	48.71
	2	TUR - Turkiye	163	18	158	339	48.08
	3	ITA - Italy	166	14	181	361	45.98
	4	CRO - Croatia	156	44	176	376	41.49
	5	GRE - Greece	145	35	188	368	39.40
	6	ALG - Algeria	68	17	111	196	34.69
	7	ESP - Spain	142	44	236	422	33.65
	8	EGY - Egypt	151	49	258	458	32.97
	9	MKD - North Macedonia	65	13	130	208	31.25
	10	TUN - Tunisia	128	30	252	410	31.22
	11	FRA - France	50	22	100	172	29.07
<b>Tournament Totals</b>			1423	305	1970	3698	38.48

### LEGEND

Avg. Average

Eff. % Efficiency

Rk Rank

Succ. Success %



ألعاب البحر الأبيض المتوسط  
MEDITERRANEAN GAMES  
JEUX MÉDITERRANÉENS  
du 25 juin au 06 juillet

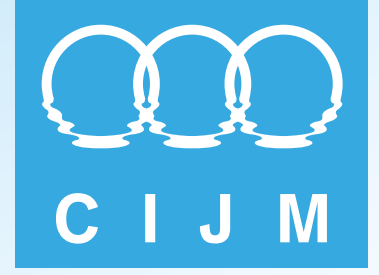

## Results Book



# Weightlifting



**TOSYALI  
ALGERIE**

Fer et Acier

سوناطراي



sonarach



microplus  
DATA PROCESSING & TIMING  
[www.microplustiming.com](http://www.microplustiming.com)





**Competition Schedule**  
**Calendrier des compétitions**

As of THU 30 JUN 2022 at 14:00

Date	Start Time	Estimated Finish Time	Event
FRI 01 July	10:00	12:00	Women's 49kg, Final
	17:00	19:00	Men's 61kg, Final
SAT 02 July	10:00	12:00	Women's 59kg, Final
	17:00	19:00	Men's 73kg, Final
SUN 03 July	10:00	12:00	Women's 71kg, Final
	17:00	19:00	Men's 89kg, Final
MON 04 July	11:00	13:00	Men's 102kg, Final
	17:00	19:00	Men's +102kg, Final



Entry List by NOC  
Entry List by NOC

NOC	Name	Gender	Date of Birth	Bodyweight Category	Entry Total
<b>ALB - ALBANIA</b>					
1	QERIMAJ Erkand	M	10 AUG 1988	73 kg	320
2	META Albert	M	12 MAY 1995	+102 kg	310
<b>ALG - ALGERIA</b>					
1	KATBI Nadia	F	26 JUN 2002	49 kg	125
2	LAGHOUATI Fatima Zohra	F	27 FEB 1999	59 kg	180
3	HAMMADI Maghnia	F	22 FEB 2000	71 kg	210
4	AINOUAZANE Abdelkader	M	22 SEP 1994	61 kg	250
5	FARFJALLAH Samir	M	18 MAY 1998	73 kg	310
6	TOUAIRI Faris	M	11 JUN 1999	89 kg	350
7	TOUAIRI Aymen	M	11 SEP 1998	102 kg	360
8	BIDANI Walid	M	11 JUN 1994	+102 kg	400
<b>BIH - BOSNIA AND HERZEGOVINA</b>					
1	DURAK Faris	M	25 SEP 2002	61 kg	180
2	SMAJIC Dino	M	05 JUL 1997	102 kg	275
<b>CYP - CYPRUS</b>					
1	MARTASIDIS Antonis	M	14 JUN 1992	89 kg	340
<b>EGY - EGYPT</b>					
1	IBRAHIM Basma	F	27 JUN 1995	59 kg	205
2	ABDELTAWWAB Roufida	F	01 OCT 2003	71 kg	220
3	SAID Neama	F	15 NOV 2002	71 kg	230
4	ELTAMADI Ahmed	M	16 JAN 1999	61 kg	255
5	MOHAMED Ahmed	M	21 JUL 1996	73 kg	310
6	ABOKAHLA Karim	M	11 NOV 1996	89 kg	355
7	ALI Ahmed	M	10 JAN 1999	102 kg	355
8	GABER Ahmed	M	18 JAN 1996	+102 kg	390
<b>ESP - SPAIN</b>					
1	HERNANDEZ MARTIN Atenery	F	10 DEC 1994	49 kg	170
2	SKANDI EL ASAAD Mouna	F	10 JAN 1992	59 kg	190
3	HERNANDEZ MARTIN Ilia	F	12 APR 1998	71 kg	210
4	BRACHI GARCIA Josue	M	08 SEP 1992	61 kg	245
5	SANCHEZ LOPEZ David	M	20 JUL 1994	73 kg	300
6	LISTE VIANO Martin	M	11 JUN 1996	89 kg	310
7	RUIZ I VELASCO Marcos	M	13 OCT 1996	102 kg	370



Entry List by NOC  
Entry List by NOC

NOC	Name	Gender	Date of Birth	Bodyweight Category	Entry Total
<b>FRA - FRANCE</b>					
1	RIGAUD Garance	F	12 NOV 1999	59 kg	185
2	GRAILLOT Vicky	F	02 JUL 2000	71 kg	215
3	TCHAKOUNTE Dora	F	23 MAR 1995	71 kg	215
4	KINGUE MATAM Bernardin	M	20 MAY 1990	73 kg	310
5	VAUTARD Brandon	M	09 SEP 1996	89 kg	340
6	IMADOUCHENE Romain	M	05 SEP 1995	102 kg	375
<b>GRE - GREECE</b>					
1	GEORGOPOULOU Sofia	F	22 SEP 2000	59 kg	200
2	REVENIKIOTI Eleni	F	26 MAY 1997	71 kg	200
3	IAKOVIDIS Theodoros	M	12 FEB 1991	89 kg	340
4	STROUMPIS Efstathios	M	12 JUL 1993	102 kg	340
<b>ITA - ITALY</b>					
1	IMPERIO Giulia	F	07 DEC 2001	49 kg	185
2	MAGISTRIS Lucrezia	F	21 APR 1999	59 kg	207
3	BRUNELLI Carlotta	F	11 APR 1993	71 kg	203
4	ZANNI Mirko	M	16 OCT 1997	73 kg	330
5	PIZZOLATO Antonino	M	20 AUG 1996	89 kg	372
6	FICCO Cristiano Giuseppe	M	05 APR 2001	102 kg	368
<b>LBA - LIBYA</b>					
1	SHABI Ahsaan	M	22 MAR 1997	73 kg	280
2	ALAJEEMI Omar	M	25 JUL 1999	89 kg	300
3	ABUZRIBA Ahmed	M	16 APR 2000	102 kg	330
<b>LBN - LEBANON</b>					
1	EL TON Andreana	F	09 NOV 1996	71 kg	190
2	FATTOUH Mahassen Hala	F	27 AUG 1989	71 kg	195
<b>MAR - MAROC</b>					
1	FAJRESLAM Maha	F	04 JUL 2003	49 kg	130
<b>SLO - SLOVENIA</b>					
1	STESL Nastasja	F	28 MAY 1991	59 kg	160
2	SKEDELJ Jure	M	24 JUL 1995	102 kg	290



Entry List by NOC  
Entry List by NOC

NOC	Name	Gender	Date of Birth	Bodyweight Category	Entry Total
<b>SRB - SERBIA</b>					
1	BJELIC Sonja	F	17 JUL 1999	71 kg	190
2	VLADISAVLJEV Stevan	M	04 JUL 1999	61 kg	255
<b>SYR - SYRIA</b>					
1	ASAAD Man	M	20 NOV 1993	+102 kg	410
<b>TUN - TUNISIA</b>					
1	CHIHAI Zahra	F	27 AUG 1994	49 kg	170
2	BELKHIR Ghofrane	F	11 AUG 2001	59 kg	220
3	GESMI Jawaher	F	05 SEP 1999	71 kg	200
4	BOUHIJBHA Amine	M	28 FEB 1996	61 kg	270
5	BEN HNIA Karem	M	13 NOV 1994	73 kg	340
6	BACHA Aymen	M	26 OCT 1999	102 kg	385
<b>TUR - TURKIYE</b>					
1	ERDOGAN Saziye	F	23 FEB 1992	49 kg	170
2	OZKAN Cansel	F	26 FEB 2002	59 kg	200
3	GUNGOR Nuray	F	08 MAY 2000	71 kg	220
4	HARDAL Ferdi	M	31 DEC 1996	61 kg	280
5	OZBEK Muhammed Furkan	M	24 JAN 2001	73 kg	330
6	ERDOGDU Celil	M	05 DEC 1997	89 kg	340
7	DEMIRCI Onur	M	07 AUG 2003	102 kg	350
8	OFLAZ Ali	M	01 OCT 2003	+102 kg	340



### Number of Entries by NOC

		Combined		
	NOC	Women	Men	Sum
1	ALB		2	2
2	ALG	3	5	8
3	BIH		2	2
4	CYP		1	1
5	EGY	3	5	8
6	ESP	3	4	7
7	FRA	3	3	6
8	GRE	2	2	4
9	ITA	3	3	6
10	LBA		3	3
11	LBN	2		2
12	MAR	1		1
13	SLO	1	1	2
14	SRB	1	1	2
15	SYR		1	1
16	TUN	2	3	5
17	TUR	3	5	8
	Sum	<b>27</b>	<b>41</b>	<b>68</b>

		Women			
	NOC	49	59	71	
1	ALG	1	1	1	
2	EGY		1	2	
3	ESP	1	1	1	
4	FRA		1	2	
5	GRE		1	1	
6	ITA	1	1	1	
7	LBN			2	
8	MAR	1			
9	SLO		1		
10	SRB			1	
11	TUN	1	1		
12	TUR	1	1	1	
	Sum	<b>6</b>	<b>9</b>	<b>12</b>	

		Men				
	NOC	61	73	89	102	+102
1	ALB		1			1
2	ALG	1	1	1	1	1
3	BIH	1			1	
4	CYP			1		
5	EGY	1	1	1	1	1
6	ESP	1	1	1	1	
7	FRA		1	1	1	
8	GRE			1	1	
9	ITA		1	1	1	
10	LBA		1	1	1	
11	SLO				1	
12	SRB	1				
13	SYR					1
14	TUN	1	1		1	
15	TUR	1	1	1	1	1
	Sum	<b>7</b>	<b>9</b>	<b>9</b>	<b>11</b>	<b>5</b>



## Timetable

As of THU 30 JUN 2022 at 14:00

Sess.	Gender	Category	Athletes	Date	Weigh-in	Start	Jury	Ref.	Doc.	Secr.	C.M.	T.C.	T.K.	Spk.
1	Women	49 KG	6	07-01	08:00	10:00	1	1	1	1	1	1	1	1
2	Men	61 KG	7	07-01	15:00	17:00	2	2	1	1	2	2	1	1
3	Women	59 KG	9	07-02	08:00	10:00	1	2	1	1	2	2	1	1
4	Men	73 KG	9	07-02	15:00	17:00	2	1	1	1	1	1	1	1
5	Women	71 KG	13	07-03	08:00	10:00	2	1	1	1	1	1	1	1
6	Men	89 KG	9	07-03	15:00	17:00	1	2	1	1	2	2	1	1
7	Men	102 KG	11	07-04	08:00	10:00	2	2	1	1	2	2	1	1
8	Men	+102 KG	5	07-04	15:00	17:00	1	1	1	1	1	1	1	1

### LEGEND

**Sess.** Session number   **Ref** Referees   **Doc.** Doctors   **Secr.** Secretaries   **C.M.** Chief Marshalls   **T.C.** Technical Controllers   **T.K.** Time Keeper   **Spk.** Speaker



## MEDALLISTS

As of MON 04 JUL 2022 at 19:35

After 15 of 24 events

Event	Date	Medal	Name	NOC	Total
W 49 kg Snatch	01 JUL 2022	GOLD	IMPERIO Giulia	ITA	83
		SILVER	HERNANDEZ MARTIN Atenery	ESP	78
		BRONZE	ERDOGAN Saziye	TUR	75
W 49 kg C & Jerk	01 JUL 2022	GOLD	IMPERIO Giulia	ITA	97
		SILVER	HERNANDEZ MARTIN Atenery	ESP	96
		BRONZE	ERDOGAN Saziye	TUR	95
M 61 kg Snatch	01 JUL 2022	GOLD	HARDAL Ferdi	TUR	124
		SILVER	ELTAMADI Ahmed	EGY	120
		BRONZE	BOUHIJBHA Amine	TUN	116
M 61 kg C & Jerk	01 JUL 2022	GOLD	HARDAL Ferdi	TUR	153
		SILVER	ELTAMADI Ahmed	EGY	152
		BRONZE	BOUHIJBHA Amine	TUN	150
W 59 kg Snatch	02 JUL 2022	GOLD	MAGISTRIS Lucrezia	ITA	95
		SILVER	GEORGOPOULOU Sofia	GRE	94
		BRONZE	OZKAN Cansel	TUR	92
W 59 kg C & Jerk	02 JUL 2022	GOLD	BELKHIR Ghofrane	TUN	115
		SILVER	MAGISTRIS Lucrezia	ITA	114
		BRONZE	IBRAHIM Basma	EGY	113
M 73 kg Snatch	02 JUL 2022	GOLD	ZANNI Mirko	ITA	150
		SILVER	QERIMAJ Erkand	ALB	149
		BRONZE	BEN HNIA Karem	TUN	147
M 73 kg C & Jerk	02 JUL 2022	GOLD	BEN HNIA Karem	TUN	185
		SILVER	OZBEK Muhammed Furkan	TUR	184
		BRONZE	ZANNI Mirko	ITA	177



## MEDALLISTS

As of MON 04 JUL 2022 at 19:35

After 15 of 24 events

Event	Date	Medal	Name	NOC	Total
W 71 kg Snatch	03 JUL 2022	GOLD	SAID Naema	EGY	101
		SILVER	HAMMADI Maghnia	ALG	100
		BRONZE	GUNGOR Nuray	TUR	99
W 71 kg C & Jerk	03 JUL 2022	GOLD	SAID Naema	EGY	125
		SILVER	GUNGOR Nuray	TUR	122
		BRONZE	HAMMADI Maghnia	ALG	121
M 89 kg Snatch	03 JUL 2022	GOLD	PIZZOLATO Antonino	ITA	172
		SILVER	ABOKAHLA Karim	EGY	171
		BRONZE	TOUAIRI Faris	ALG	161
M 89 kg C & Jerk	03 JUL 2022	GOLD	PIZZOLATO Antonino	ITA	213
		SILVER	ABOKAHLA Karim	EGY	212
		BRONZE	VAUTARD Brandon	FRA	192
M 102 kg Snatch	04 JUL 2022	GOLD	RUIZ I VELASCO Marcos	ESP	175
		SILVER	BACHA Aymen	TUN	174
		BRONZE	FICCO Cristiano Giuseppe	ITA	164
M 102 kg C & Jerk	04 JUL 2022	GOLD	BACHA Aymen	TUN	210
		SILVER	RUIZ I VELASCO Marcos	ESP	208
		BRONZE	ALI Ahmed	EGY	208
M +102 kg Snatch	04 JUL 2022	GOLD	BIDANI Walid	ALG	202
		SILVER	ASAAD Man	SYR	197
		BRONZE	GABER Ahmed	EGY	170
M +102 kg C & Jerk	04 JUL 2022	GOLD	ASAAD Man	SYR	247
		SILVER	BIDANI Walid	ALG	235
		BRONZE	GABER Ahmed	EGY	231





Entry List by B.W. Category - Women's 49kg  
Entry List by B.W. Category - Femmes 49kg

Name	NOC	Date of Birth	Entry Total	Lot Number
IMPERIO Giulia	ITA	07 DEC 2001	185	344
ERDOGAN Saziye	TUR	23 FEB 1992	170	516
CHIHI Zahra	TUN	27 AUG 1994	170	580
HERNANDEZ MARTIN Atenery	ESP	10 DEC 1994	170	844
FAJRESLAM Maha	MAR	04 JUL 2003	130	337
KATBI Nadia	ALG	26 JUN 2002	125	72

Number of athletes: 6



**SNATCH**  
**Women's 49 kg**

Rank	Name	NOC	Date of Birth	Group	1	2	3	Res.
1	IMPERIO Giulia	ITA	07 DEC 2001	A	77	79	83	83
2	HERNANDEZ MARTIN Atenery	ESP	10 DEC 1994	A	76	78	<del>80</del>	78
3	ERDOGAN Saziye	TUR	23 FEB 1992	A	73	75	<del>79</del>	75
4	FAJRESLAM Maha	MAR	04 JUL 2003	A	63	<del>66</del>	<del>66</del>	63
5	KATBI Nadia	ALG	26 JUN 2002	A	52	<del>55</del>	57	57
	CHIHAI Zahra	TUN	27 AUG 1994	A	<del>74</del>	---	---	---



**MEDALLISTS**  
**Women's 49 kg - Snatch**

MEDAL	Name	NOC	Total
GOLD	IMPERIO Giulia	ITA	83
SILVER	HERNANDEZ MARTIN Atenery	ESP	78
BRONZE	ERDOGAN Saziye	TUR	75



Entry List by B.W. Category - Women's 49kg  
Entry List by B.W. Category - Femmes 49kg

Name	NOC	Date of Birth	Entry Total	Lot Number
IMPERIO Giulia	ITA	07 DEC 2001	185	344
ERDOGAN Saziye	TUR	23 FEB 1992	170	516
CHIHI Zahra	TUN	27 AUG 1994	170	580
HERNANDEZ MARTIN Atenery	ESP	10 DEC 1994	170	844
FAJRESLAM Maha	MAR	04 JUL 2003	130	337
KATBI Nadia	ALG	26 JUN 2002	125	72

Number of athletes: 6



**CLEAN & JERK**  
**Women's 49 kg**

Rank	Name	NOC	Date of Birth	Group	1	2	3	Res.
1	IMPERIO Giulia	ITA	07 DEC 2001	A	95	97	<del>102</del>	97
2	HERNANDEZ MARTIN Atenery	ESP	10 DEC 1994	A	93	96	<del>98</del>	96
3	ERDOGAN Saziye	TUR	23 FEB 1992	A	92	95	<del>97</del>	95
4	FAJRESLAM Maha	MAR	04 JUL 2003	A	77	<del>82</del>	<del>83</del>	77
5	KATBI Nadia	ALG	26 JUN 2002	A	65	<del>70</del>	<del>70</del>	65
	CHIHAI Zahra	TUN	27 AUG 1994	A	---	---	---	---



**MEDALLISTS**  
**Women's 49 kg - Clean & Jerk**

MEDAL	Name	NOC	Total
GOLD	IMPERIO Giulia	ITA	97
SILVER	HERNANDEZ MARTIN Atenery	ESP	96
BRONZE	ERDOGAN Saziye	TUR	95



Entry List by B.W. Category - Women's 59kg  
Entry List by B.W. Category - Femmes 59kg

Name	NOC	Date of Birth	Entry Total	Lot Number
BELKHIR Ghofrane	TUN	11 AUG 2001	220	925
MAGISTRIS Lucrezia	ITA	21 APR 1999	207	635
IBRAHIM Basma	EGY	27 JUN 1995	205	448
GEORGOPOULOU Sofia	GRE	22 SEP 2000	200	35
OZKAN Cansel	TUR	26 FEB 2002	200	475
SKANDI EL ASAAD Mouna	ESP	10 JAN 1992	190	288
RIGAUD Garance	FRA	12 NOV 1999	185	636
LAGHOUATI Fatima Zohra	ALG	27 FEB 1999	180	845
STESL Nastasja	SLO	28 MAY 1991	160	148

Number of athletes: 9



**SNATCH**  
**Women's 59 kg**

Rank	Name	NOC	Date of Birth	Group	1	2	3	Res.
1	MAGISTRIS Lucrezia	ITA	21 APR 1999	A	90	93	95	95
2	GEORGOPOULOU Sofia	GRE	22 SEP 2000	A	89	92	94	94
3	OZKAN Cansel	TUR	26 FEB 2002	A	85	90	92	92
4	BELKHIR Ghofrane	TUN	11 AUG 2001	A	<del>91</del>	<del>91</del>	91	91
5	IBRAHIM Basma	EGY	27 JUN 1995	A	85	88	<del>91</del>	88
6	SKANDI EL ASAAD Mouna	ESP	10 JAN 1992	A	82	<del>84</del>	<del>84</del>	82
7	RIGAUD Garance	FRA	12 NOV 1999	A	75	80	82	82
8	STESL Nastasja	SLO	28 MAY 1991	A	73	<del>76</del>	77	77
9	LAGHOUATI Fatima Zohra	ALG	27 FEB 1999	A	76	<del>80</del>	<del>81</del>	76





**MEDALLISTS**  
**Women's 59 kg - Snatch**

MEDAL	Name	NOC	Total
GOLD	MAGISTRIS Lucrezia	ITA	95
SILVER	GEORGOPOULOU Sofia	GRE	94
BRONZE	OZKAN Cansel	TUR	92



Entry List by B.W. Category - Women's 59kg  
Entry List by B.W. Category - Femmes 59kg

Name	NOC	Date of Birth	Entry Total	Lot Number
BELKHIR Ghofrane	TUN	11 AUG 2001	220	925
MAGISTRIS Lucrezia	ITA	21 APR 1999	207	635
IBRAHIM Basma	EGY	27 JUN 1995	205	448
GEORGOPOULOU Sofia	GRE	22 SEP 2000	200	35
OZKAN Cansel	TUR	26 FEB 2002	200	475
SKANDI EL ASAAD Mouna	ESP	10 JAN 1992	190	288
RIGAUD Garance	FRA	12 NOV 1999	185	636
LAGHOUATI Fatima Zohra	ALG	27 FEB 1999	180	845
STESL Nastasja	SLO	28 MAY 1991	160	148

Number of athletes: 9



**CLEAN & JERK**  
**Women's 59 kg**

Rank	Name	NOC	Date of Birth	Group	1	2	3	Res.
1	BELKHIR Ghofrane	TUN	11 AUG 2001	A	112	115	—	115
2	MAGISTRIS Lucrezia	ITA	21 APR 1999	A	111	114	<del>118</del>	114
3	IBRAHIM Basma	EGY	27 JUN 1995	A	110	113	<del>116</del>	113
4	SKANDI EL ASAAD Mouna	ESP	10 JAN 1992	A	107	111	<del>113</del>	111
5	GEORGOPOULOU Sofia	GRE	22 SEP 2000	A	108	<del>113</del>	<del>115</del>	108
6	OZKAN Cansel	TUR	26 FEB 2002	A	106	<del>112</del>	—	106
7	LAGHOUATI Fatima Zohra	ALG	27 FEB 1999	A	95	100	<del>103</del>	100
8	RIGAUD Garance	FRA	12 NOV 1999	A	90	95	<del>100</del>	95
9	STESL Nastasja	SLO	28 MAY 1991	A	91	95	<del>97</del>	95



**MEDALLISTS**  
**Women's 59 kg - Snatch**

MEDAL	Name	NOC	Total
GOLD	MAGISTRIS Lucrezia	ITA	95
SILVER	GEORGOPOULOU Sofia	GRE	94
BRONZE	OZKAN Cansel	TUR	92



Entry List by B.W. Category - Women's 71kg  
Entry List by B.W. Category - Femmes 71kg

Name	NOC	Date of Birth	Entry Total	Lot Number
SAID Neama	EGY	15 NOV 2002	230	970
ABDELTAWWAB Roufida	EGY	01 OCT 2003	220	767
GUNGOR Nuray	TUR	08 MAY 2000	220	827
GRAILLOT Vicky	FRA	02 JUL 2000	215	121
TCHAKOUNTE Dora	FRA	23 MAR 1995	215	439
HERNANDEZ MARTIN Ilia	ESP	12 APR 1998	210	219
HAMMADI Maghnia	ALG	22 FEB 2000	210	394
BRUNELLI Carlotta	ITA	11 APR 1993	203	982
REVENIKIOTI Eleni	GRE	26 MAY 1997	200	291
GESMI Jawaher	TUN	05 SEP 1999	200	341
FATTOUH Mahassen Hala	LBN	27 AUG 1989	195	481
BJELIC Sonja	SRB	17 JUL 1999	190	743
EL TON Andreana	LBN	09 NOV 1996	190	886

Number of athletes: 13



**SNATCH**  
**Women's 71 kg**

Rank	Name	NOC	Date of Birth	Group	1	2	3	Res.
1	SAID Neama	EGY	15 NOV 2002	A	<del>100</del>	<del>101</del>	101	101
2	HAMMADI Maghnia	ALG	22 FEB 2000	A	91	96	100	100
3	GUNGOR Nuray	TUR	08 MAY 2000	A	95	99	<del>101</del>	99
4	TCHAKOUNTE Dora	FRA	23 MAR 1995	A	92	97	<del>101</del>	97
5	BRUNELLI Carlotta	ITA	11 APR 1993	A	<del>90</del>	90	93	93
6	HERNANDEZ MARTIN Iliia	ESP	12 APR 1998	A	<del>90</del>	<del>90</del>	92	92
7	ABDELTAWWAB Roufida	EGY	01 OCT 2003	A	88	91	<del>94</del>	91
8	FATTOUH Mahassen Hala	LBN	27 AUG 1989	A	88	<del>93</del>	<del>98</del>	88
9	GRAILLOT Vicky	FRA	02 JUL 2000	A	<del>88</del>	88	<del>91</del>	88
10	BJELIC Sonja	SRB	17 JUL 1999	A	<del>83</del>	85	<del>89</del>	85
11	EL TON Andreana	LBN	09 NOV 1996	A	<del>85</del>	<del>85</del>	85	85
12	GESMI Jawaher	TUN	05 SEP 1999	A	80	84	<del>86</del>	84
13	REVENIKIOTI Eleni	GRE	26 MAY 1997	A	83	<del>86</del>	<del>86</del>	83



**MEDALLISTS**  
**Women's 71 kg - Snatch**

MEDAL	Name	NOC	Total
GOLD	SAID Neama	EGY	101
SILVER	HAMMADI Maghnia	ALG	100
BRONZE	GUNGOR Nuray	TUR	99



Entry List by B.W. Category - Women's 71kg  
Entry List by B.W. Category - Femmes 71kg

Name	NOC	Date of Birth	Entry Total	Lot Number
SAID Neama	EGY	15 NOV 2002	230	970
ABDELTAWWAB Roufida	EGY	01 OCT 2003	220	767
GUNGOR Nuray	TUR	08 MAY 2000	220	827
GRAILLOT Vicky	FRA	02 JUL 2000	215	121
TCHAKOUNTE Dora	FRA	23 MAR 1995	215	439
HERNANDEZ MARTIN Ilia	ESP	12 APR 1998	210	219
HAMMADI Maghnia	ALG	22 FEB 2000	210	394
BRUNELLI Carlotta	ITA	11 APR 1993	203	982
REVENIKIOTI Eleni	GRE	26 MAY 1997	200	291
GESMI Jawaher	TUN	05 SEP 1999	200	341
FATTOUH Mahassen Hala	LBN	27 AUG 1989	195	481
BJELIC Sonja	SRB	17 JUL 1999	190	743
EL TON Andreana	LBN	09 NOV 1996	190	886

Number of athletes: 13





**CLEAN & JERK**  
**Women's 71 kg**

Rank	Name	NOC	Date of Birth	Group	1	2	3	Res.
1	SAID Neama	EGY	15 NOV 2002	A	121	125	---	125
2	GUNGOR Nuray	TUR	08 MAY 2000	A	118	<del>122</del>	122	122
3	HAMMADI Maghnia	ALG	22 FEB 2000	A	117	121	<del>127</del>	121
4	HERNANDEZ MARTIN Iliia	ESP	12 APR 1998	A	118	121	<del>123</del>	121
5	ABDELTAWWAB Roufida	EGY	01 OCT 2003	A	118	<del>122</del>	<del>122</del>	118
6	REVENIKIOTI Eleni	GRE	26 MAY 1997	A	110	114	116	116
7	GESMI Jawaher	TUN	05 SEP 1999	A	114	<del>118</del>	<del>119</del>	114
8	TCHAKOUNTE Dora	FRA	23 MAR 1995	A	110	114	<del>119</del>	114
9	GRAILLOT Vicky	FRA	02 JUL 2000	A	<del>113</del>	<del>113</del>	114	114
10	FATTOUH Mahassen Hala	LBN	27 AUG 1989	A	<del>110</del>	110	<del>116</del>	110
11	BRUNELLI Carlotta	ITA	11 APR 1993	A	105	<del>111</del>	<del>111</del>	105
12	BJELIC Sonja	SRB	17 JUL 1999	A	95	100	<del>103</del>	100
	EL TON Andreana	LBN	09 NOV 1996	A	<del>103</del>	<del>105</del>	<del>107</del>	---



**MEDALLISTS**  
**Women's 71 kg - Clean & Jerk**

MEDAL	Name	NOC	Total
GOLD	SAID Neama	EGY	125
SILVER	GUNGOR Nuray	TUR	122
BRONZE	HAMMADI Maghnia	ALG	121



Entry List by B.W. Category - Men's 61kg  
Entry List by B.W. Category - Hommes 61kg

Name	NOC	Date of Birth	Entry Total	Lot Number
HARDAL Ferdi	TUR	31 DEC 1996	280	916
BOUHIJBHA Amine	TUN	28 FEB 1996	270	968
VLADISAVLJEV Stevan	SRB	04 JUL 1999	255	674
ELTAMADI Ahmed	EGY	16 JAN 1999	255	903
AINOUAZANE Abdelkader	ALG	22 SEP 1994	250	357
BRACHI GARCIA Josue	ESP	08 SEP 1992	245	447
DURAK Faris	BIH	25 SEP 2002	180	547

Number of athletes: 7



**SNATCH**  
**Men's 61 kg**

Rank	Name	NOC	Date of Birth	Group	1	2	3	Res.
1	HARDAL Ferdi	TUR	31 DEC 1996	A	124	<del>128</del>	---	124
2	ELTAMADI Ahmed	EGY	16 JAN 1999	A	117	120	<del>125</del>	120
3	BOUHIJBHA Amine	TUN	28 FEB 1996	A	116	<del>118</del>	---	116
4	BRACHI GARCIA Josue	ESP	08 SEP 1992	A	111	116	<del>118</del>	116
5	VLADISAVLJEV Stevan	SRB	04 JUL 1999	A	105	<del>110</del>	110	110
	DURAK Faris	BIH	25 SEP 2002	A	<del>86</del>	<del>86</del>	<del>86</del>	---
	AINOVAZANE Abdelkader	ALG	22 SEP 1994	A	<del>115</del>	<del>115</del>	<del>118</del>	---



**MEDALLISTS**  
**Men's 102 kg - Snatch**

MEDAL	Name	NOC	Total
GOLD	RUIZ I VELASCO Marcos	ESP	175
SILVER	BACHA Aymen	TUN	174
BRONZE	FICCO Cristiano Giuseppe	ITA	164



Entry List by B.W. Category - Men's 61kg  
Entry List by B.W. Category - Hommes 61kg

Name	NOC	Date of Birth	Entry Total	Lot Number
HARDAL Ferdi	TUR	31 DEC 1996	280	916
BOUHIJBHA Amine	TUN	28 FEB 1996	270	968
VLADISAVLJEV Stevan	SRB	04 JUL 1999	255	674
ELTAMADI Ahmed	EGY	16 JAN 1999	255	903
AINOUAZANE Abdelkader	ALG	22 SEP 1994	250	357
BRACHI GARCIA Josue	ESP	08 SEP 1992	245	447
DURAK Faris	BIH	25 SEP 2002	180	547

Number of athletes: 7



**CLEAN & JERK**  
**Men's 61 kg**

Rank	Name	NOC	Date of Birth	Group	1	2	3	Res.
1	HARDAL Ferdi	TUR	31 DEC 1996	A	147	151	153	153
2	ELTAMADI Ahmed	EGY	16 JAN 1999	A	143	150	152	152
3	BOUHIJBHA Amine	TUN	28 FEB 1996	A	142	<del>145</del>	150	150
4	BRACHI GARCIA Josue	ESP	08 SEP 1992	A	<del>135</del>	139	<del>144</del>	139
5	AINOUAZANE Abdelkader	ALG	22 SEP 1994	A	135	<del>143</del>	<del>146</del>	135
6	VLADISAVLJEV Stevan	SRB	04 JUL 1999	A	130	<del>136</del>	---	130
7	DURAK Faris	BIH	25 SEP 2002	A	102	<del>107</del>	---	102



**MEDALLISTS**  
**Men's 61 kg - Clean & Jerk**

MEDAL	Name	NOC	Total
GOLD	HARDAL Ferdi	TUR	153
SILVER	ELTAMADI Ahmed	EGY	152
BRONZE	BOUHIJBHA Amine	TUN	150





Entry List by B.W. Category - Men's 73kg  
Entry List by B.W. Category - Hommes 73kg

Name	NOC	Date of Birth	Entry Total	Lot Number
BEN HNIA Karem	TUN	13 NOV 1994	340	144
ZANNI Mirko	ITA	16 OCT 1997	330	440
OZBEK Muhammed Furkan	TUR	24 JAN 2001	330	918
QERIMAJ Erkand	ALB	10 AUG 1988	320	435
FARFJALLAH Samir	ALG	18 MAY 1998	310	312
KINGUE MATAM Bernardin	FRA	20 MAY 1990	310	369
MOHAMED Ahmed	EGY	21 JUL 1996	310	434
SANCHEZ LOPEZ David	ESP	20 JUL 1994	300	3
SHABI Ahsaan	LBA	22 MAR 1997	280	808

Number of athletes: 9



**SNATCH**  
**Men's 73 kg**

Rank	Name	NOC	Date of Birth	Group	1	2	3	Res.
1	ZANNI Mirko	ITA	16 OCT 1997	A	147	<del>149</del>	150	150
2	QERIMAJ Erkand	ALB	10 AUG 1988	A	<del>148</del>	<del>148</del>	149	149
3	BEN HNIA Karem	TUN	13 NOV 1994	A	<del>147</del>	147	<del>149</del>	147
4	MOHAMED Ahmed	EGY	21 JUL 1996	A	<del>146</del>	146	<del>149</del>	146
5	OZBEK Muhammed Furkan	TUR	24 JAN 2001	A	<del>145</del>	145	<del>148</del>	145
6	FARFJALLAH Samir	ALG	18 MAY 1998	A	136	141	<del>148</del>	141
7	SANCHEZ LOPEZ David	ESP	20 JUL 1994	A	135	140	<del>143</del>	140
8	SHABI Ahsaan	LBA	22 MAR 1997	A	130	136	<del>141</del>	136



**MEDALLISTS**  
**Men's 73 kg - Snatch**

MEDAL	Name	NOC	Total
GOLD	ZANNI Mirko	ITA	150
SILVER	QERIMAJ Erkand	ALB	149
BRONZE	BEN HNIA Karem	TUN	147



Entry List by B.W. Category - Men's 73kg  
Entry List by B.W. Category - Hommes 73kg

Name	NOC	Date of Birth	Entry Total	Lot Number
BEN HNIA Karem	TUN	13 NOV 1994	340	144
ZANNI Mirko	ITA	16 OCT 1997	330	440
OZBEK Muhammed Furkan	TUR	24 JAN 2001	330	918
QERIMAJ Erkand	ALB	10 AUG 1988	320	435
FARFJALLAH Samir	ALG	18 MAY 1998	310	312
KINGUE MATAM Bernardin	FRA	20 MAY 1990	310	369
MOHAMED Ahmed	EGY	21 JUL 1996	310	434
SANCHEZ LOPEZ David	ESP	20 JUL 1994	300	3
SHABI Ahsaan	LBA	22 MAR 1997	280	808

Number of athletes: 9



**CLEAN & JERK**  
**Men's 73 kg**

Rank	Name	NOC	Date of Birth	Group	1	2	3	Res.
1	BEN HNIA Karem	TUN	13 NOV 1994	A	180	182	185	185
2	OZBEK Muhammed Furkan	TUR	24 JAN 2001	A	<del>181</del>	181	184	184
3	ZANNI Mirko	ITA	16 OCT 1997	A	<del>177</del>	177	---	177
4	FARFJALLAH Samir	ALG	18 MAY 1998	A	171	<del>178</del>	<del>178</del>	171
5	SHABI Ahsaan	LBA	22 MAR 1997	A	160	<del>170</del>	170	170
6	SANCHEZ LOPEZ David	ESP	20 JUL 1994	A	165	<del>170</del>	---	165
	MOHAMED Ahmed	EGY	21 JUL 1996	A	<del>176</del>	<del>177</del>	<del>178</del>	---
	QERIMAJ Erkand	ALB	10 AUG 1988	A	---	---	---	---



**MEDALLISTS**  
**Men's 73 kg - Clean & Jerk**

MEDAL	Name	NOC	Total
GOLD	BEN HNIA Karem	TUN	185
SILVER	OZBEK Muhammed Furkan	TUR	184
BRONZE	ZANNI Mirko	ITA	177



Entry List by B.W. Category - Men's 89kg  
Entry List by B.W. Category - Hommes 89kg

Name	NOC	Date of Birth	Entry Total	Lot Number
PIZZOLATO Antonino	ITA	20 AUG 1996	372	751
ABOKAHLA Karim	EGY	11 NOV 1996	355	675
TOUAIRI Faris	ALG	11 JUN 1999	350	571
IAKOVIDIS Theodoros	GRE	12 FEB 1991	340	61
ERDOGDU Celil	TUR	05 DEC 1997	340	285
MARTASIDIS Antonis	CYP	14 JUN 1992	340	437
VAUTARD Brandon	FRA	09 SEP 1996	340	622
LISTE VIANO Martin	ESP	11 JUN 1996	310	371
ALAJEEMI Omar	LBA	25 JUL 1999	300	696

Number of athletes: 9



**SNATCH**  
**Men's 89 kg**

Rank	Name	NOC	Date of Birth	Group	1	2	3	Res.
1	PIZZOLATO Antonino	ITA	20 AUG 1996	A	170	172	---	172
2	ABOKAHLA Karim	EGY	11 NOV 1996	A	160	165	171	171
3	TOUAIRI Faris	ALG	11 JUN 1999	A	161	<del>166</del>	<del>166</del>	161
4	IAKOVIDIS Theodoros	GRE	12 FEB 1991	A	152	157	<del>161</del>	157
5	ERDOGDU Celil	TUR	05 DEC 1997	A	153	<del>158</del>	<del>158</del>	153
6	MARTASIDIS Antonis	CYP	14 JUN 1992	A	145	150	<del>153</del>	150
7	ALAJEEMI Omar	LBA	25 JUL 1999	A	138	144	148	148
8	LISTE VIANO Martin	ESP	11 JUN 1996	A	<del>145</del>	145	<del>151</del>	145
9	VAUTARD Brandon	FRA	09 SEP 1996	A	135	<del>140</del>	140	140





**MEDALLISTS**  
**Men's 89 kg - Snatch**

MEDAL	Name	NOC	Total
GOLD	PIZZOLATO Antonino	ITA	172
SILVER	ABOKAHLA Karim	EGY	171
BRONZE	TOUAIRI Faris	ALG	161



Entry List by B.W. Category - Men's 89kg  
Entry List by B.W. Category - Hommes 89kg

Name	NOC	Date of Birth	Entry Total	Lot Number
PIZZOLATO Antonino	ITA	20 AUG 1996	372	751
ABOKAHLA Karim	EGY	11 NOV 1996	355	675
TOUAIRI Faris	ALG	11 JUN 1999	350	571
IAKOVIDIS Theodoros	GRE	12 FEB 1991	340	61
ERDOGDU Celil	TUR	05 DEC 1997	340	285
MARTASIDIS Antonis	CYP	14 JUN 1992	340	437
VAUTARD Brandon	FRA	09 SEP 1996	340	622
LISTE VIANO Martin	ESP	11 JUN 1996	310	371
ALAJEEMI Omar	LBA	25 JUL 1999	300	696

Number of athletes: 9



**CLEAN & JERK**  
**Men's 89 kg**

Rank	Name	NOC	Date of Birth	Group	1	2	3	Res.
1	PIZZOLATO Antonino	ITA	20 AUG 1996	A	<del>210</del>	210	213	213
2	ABOKAHLA Karim	EGY	11 NOV 1996	A	202	212	<del>214</del>	212
3	VAUTARD Brandon	FRA	09 SEP 1996	A	190	192	<del>200</del>	192
4	MARTASIDIS Antonis	CYP	14 JUN 1992	A	185	<del>191</del>	191	191
5	ALAJEEMI Omar	LBA	25 JUL 1999	A	175	<del>183</del>	185	185
6	IAKOVIDIS Theodoros	GRE	12 FEB 1991	A	183	<del>191</del>	<del>191</del>	183
7	LISTE VIANO Martin	ESP	11 JUN 1996	A	<del>175</del>	<del>175</del>	175	175
	ERDOGDU Celil	TUR	05 DEC 1997	A	<del>185</del>	<del>191</del>	<del>191</del>	---
	TOUAIRI Faris	ALG	11 JUN 1999	A	---	---	---	---



**MEDALLISTS**  
**Men's 89 kg - Clean & Jerk**

MEDAL	Name	NOC	Total
GOLD	PIZZOLATO Antonino	ITA	213
SILVER	ABOKAHLA Karim	EGY	212
BRONZE	VAUTARD Brandon	FRA	192



Entry List by B.W. Category - Men's 102kg  
Entry List by B.W. Category - Hommes 102kg

Name	NOC	Date of Birth	Entry Total	Lot Number
BACHA Aymen	TUN	26 OCT 1999	385	782
IMADOUCHENE Romain	FRA	05 SEP 1995	375	764
RUIZ I VELASCO Marcos	ESP	13 OCT 1996	370	776
FICCO Cristiano Giuseppe	ITA	05 APR 2001	368	583
TOUAIRI Aymen	ALG	11 SEP 1998	360	998
ALI Ahmed	EGY	10 JAN 1999	355	100
DEMIRCI Onur	TUR	07 AUG 2003	350	987
STROUMPIS Efstathios	GRE	12 JUL 1993	340	278
ABUZRIBA Ahmed	LBA	16 APR 2000	330	324
SKEDELJ Jure	SLO	24 JUL 1995	290	157
SMAJIC Dino	BIH	05 JUL 1997	275	503

Number of athletes: 11



**SNATCH**  
**Men's 102 kg**

Rank	Name	NOC	Date of Birth	Group	1	2	3	Res.
1	RUIZ I VELASCO Marcos	ESP	13 OCT 1996	A	168	172	175	175
2	BACHA Aymen	TUN	26 OCT 1999	A	167	<del>172</del>	174	174
3	FICCO Cristiano Giuseppe	ITA	05 APR 2001	A	161	164	<del>168</del>	164
4	TOUAIRI Aymen	ALG	11 SEP 1998	A	<del>162</del>	162	<del>169</del>	162
5	ALI Ahmed	EGY	10 JAN 1999	A	160	<del>168</del>	<del>168</del>	160
6	IMADOUCHENE Romain	FRA	05 SEP 1995	A	160	<del>165</del>	<del>167</del>	160
7	ABUZRIBA Ahmed	LBA	16 APR 2000	A	158	<del>164</del>	<del>169</del>	158
8	DEMIRCI Onur	TUR	07 AUG 2003	A	<del>155</del>	155	<del>163</del>	155
9	STROUMPIS Efstathios	GRE	12 JUL 1993	A	145	150	<del>155</del>	150
10	SMAJIC Dino	BIH	05 JUL 1997	A	120	130	140	140
11	SKEDELJ Jure	SLO	24 JUL 1995	A	130	<del>135</del>	135	135



**MEDALLISTS**  
**Men's 102 kg - Snatch**

MEDAL	Name	NOC	Total
GOLD	RUIZ I VELASCO Marcos	ESP	175
SILVER	BACHA Aymen	TUN	174
BRONZE	FICCO Cristiano Giuseppe	ITA	164



Entry List by B.W. Category - Men's 102kg  
Entry List by B.W. Category - Hommes 102kg

Name	NOC	Date of Birth	Entry Total	Lot Number
BACHA Aymen	TUN	26 OCT 1999	385	782
IMADOUCHENE Romain	FRA	05 SEP 1995	375	764
RUIZ I VELASCO Marcos	ESP	13 OCT 1996	370	776
FICCO Cristiano Giuseppe	ITA	05 APR 2001	368	583
TOUAIRI Aymen	ALG	11 SEP 1998	360	998
ALI Ahmed	EGY	10 JAN 1999	355	100
DEMIRCI Onur	TUR	07 AUG 2003	350	987
STROUMPIS Efstathios	GRE	12 JUL 1993	340	278
ABUZRIBA Ahmed	LBA	16 APR 2000	330	324
SKEDELJ Jure	SLO	24 JUL 1995	290	157
SMAJIC Dino	BIH	05 JUL 1997	275	503

Number of athletes: 11





**CLEAN & JERK**  
**Men's 102 kg**

Rank	Name	NOC	Date of Birth	Group	1	2	3	Res.
1	BACHA Aymen	TUN	26 OCT 1999	A	<del>205</del>	206	210	210
2	RUIZ I VELASCO Marcos	ESP	13 OCT 1996	A	200	205	208	208
3	ALI Ahmed	EGY	10 JAN 1999	A	<del>205</del>	<del>206</del>	208	208
4	FICCO Cristiano Giuseppe	ITA	05 APR 2001	A	201	<del>206</del>	207	207
5	TOUAIRI Aymen	ALG	11 SEP 1998	A	201	206	<del>209</del>	206
6	ABUZRIBA Ahmed	LBA	16 APR 2000	A	180	190	<del>200</del>	190
7	STROUMPIS Efstathios	GRE	12 JUL 1993	A	175	<del>181</del>	<del>185</del>	175
8	SKEDELJ Jure	SLO	24 JUL 1995	A	<del>165</del>	167	<del>170</del>	167
9	SMAJIC Dino	BIH	05 JUL 1997	A	150	160	165	165
	DEMIRCI Onur	TUR	07 AUG 2003	A	<del>196</del>	<del>196</del>	<del>196</del>	---
	IMADOUCHENE Romain	FRA	05 SEP 1995	A	<del>205</del>	<del>206</del>	<del>209</del>	---



**MEDALLISTS**  
**Men's 102 kg - Clean & Jerk**

MEDAL	Name	NOC	Total
GOLD	BACHA Aymen	TUN	210
SILVER	RUIZ I VELASCO Marcos	ESP	208
BRONZE	ALI Ahmed	EGY	208



Entry List by B.W. Category - Men's +102kg  
Entry List by B.W. Category - Hommes +102kg

Name	NOC	Date of Birth	Entry Total	Lot Number
ASAAD Man	SYR	20 NOV 1993	410	387
BIDANI Walid	ALG	11 JUN 1994	400	352
GABER Ahmed	EGY	18 JAN 1996	390	79
OFLAZ Ali	TUR	01 OCT 2003	340	416
META Albert	ALB	12 MAY 1995	310	272

Number of athletes: 5



**SNATCH**  
**Men's +102 kg**

Rank	Name	NOC	Date of Birth	Group	1	2	3	Res.
1	BIDANI Walid	ALG	11 JUN 1994	A	190	196	202	202
2	ASAAD Man	SYR	20 NOV 1993	A	191	197	<del>203</del>	197
3	GABER Ahmed	EGY	18 JAN 1996	A	170	<del>180</del>	<del>180</del>	170
4	OFLAZ Ali	TUR	01 OCT 2003	A	150	152	<del>160</del>	152
5	META Albert	ALB	12 MAY 1995	A	142	147	151	151



**MEDALLISTS**  
**Men's +102 kg - Snatch**

MEDAL	Name	NOC	Total
GOLD	BIDANI Walid	ALG	202
SILVER	ASAAD Man	SYR	197
BRONZE	GABER Ahmed	EGY	170



Entry List by B.W. Category - Men's +102kg  
Entry List by B.W. Category - Hommes +102kg

Name	NOC	Date of Birth	Entry Total	Lot Number
ASAAD Man	SYR	20 NOV 1993	410	387
BIDANI Walid	ALG	11 JUN 1994	400	352
GABER Ahmed	EGY	18 JAN 1996	390	79
OFLAZ Ali	TUR	01 OCT 2003	340	416
META Albert	ALB	12 MAY 1995	310	272

Number of athletes: 5



**CLEAN & JERK**  
**Men's +102 kg**

Rank	Name	NOC	Date of Birth	Group	1	2	3	Res.
1	ASAAD Man	SYR	20 NOV 1993	A	232	242	247	247
2	BIDANI Walid	ALG	11 JUN 1994	A	225	235	<del>243</del>	235
3	GABER Ahmed	EGY	18 JAN 1996	A	220	231	<del>236</del>	231
4	OFLAZ Ali	TUR	01 OCT 2003	A	186	<del>200</del>	<del>200</del>	186
5	META Albert	ALB	12 MAY 1995	A	172	180	<del>185</del>	180



**MEDALLISTS**  
**Men's +102 kg - Clean & Jerk**

MEDAL	Name	NOC	Total
GOLD	ASAAD Man	SYR	247
SILVER	BIDANI Walid	ALG	235
BRONZE	GABER Ahmed	EGY	231





ألعاب البحر الأبيض المتوسط  
MEDITERRANEAN GAMES  
JEUX MÉDITERRANÉENS  
du 25 juin au 06 juillet

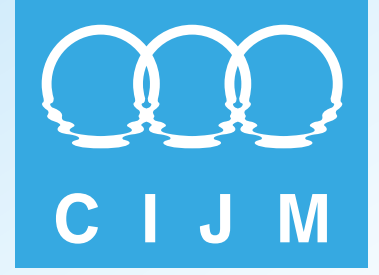

# Results Book



## Water polo



**TOSYALI  
ALGERIE**

Fer et Acier

سوناطراي



sonarach



microplus  
DATA PROCESSING & TIMING  
[www.microplustiming.com](http://www.microplustiming.com)



## Medallists by event

As of THU 30 JUN 2022 at 14:20

Event Name	Date	Medal	Name	CTRY Code
Men	THU 30 JUN 2022	Gold	<b>SERBIA</b> PAJKOVIC Petar MARAS Mitar DIMITRIJEVIC Marko GAVRILOVIC Bogdan KOJIC Nikola ANDELIC Vuk POZNANOVIC Zoran UROSEVIC Viktor KOVACEVIC Aleksandar BRESCANSKI Bogdan STANIC Petar RADULOVIC Nikola Vuk VIRIJEVIC Radosav	SRB
		Silver	<b>MONTENEGRO</b> BJELICA Andrija VUCKOVIC Balsa DRAGOVIC Danilo NIKALJEVIC Milan KRIVOKAPIC Pavle VUKSIC Milos VUKICEVIC Vladan KRIVOKAPIC Danilo VUKICEVIC Lazar BASTRICA Nedo SAMARDZIC Drasko STUPAR Danilo VUKOVIC Dusan	MNE



### Medallists by event

As of THU 30 JUN 2022 at 14:20

Event Name	Date	Medal	Name	CTRY Code
Men	THU 30 JUN 2022	Bronze	<b>SPAIN</b> TECLAS GUILLENA Xavier VILLAMAYOR I VILLAR Joan GIL CEDO Gerard IVAYLOV PATCHALIEV Daniel FRIGOLA NAVARRO Marc CASTRO FERNANDEZ Hugo LOPEZ DUART Robert IBANEZ ALVAREZ Javier PEREZ I RODRIGUEZ Jan DE LA CRUZ COLAPINTO Luca OTERO VILLALBA Javier GOMILA FAIGES Biel GARCIA PLANA Didac	ESP



## Medallists

As of THU 30 JUN 2022 at 14:19

Gold	Silver	Bronze
<b>SRB - Serbia</b>	<b>MNE - Montenegro</b>	<b>ESP - Spain</b>
1 PAJKOVIC Petar	1 BJELICA Andrija	1 TECLAS GUILLENA Xavier
2 MARAS Mitar	2 VUCKOVIC Balsa	2 VILLAMAYOR I VILLAR Joan
3 DIMITRIJEVIC Marko	3 DRAGOVIC Danilo	3 GIL CEDO Gerard
4 GAVRILOVIC Bogdan	4 NIKALJEVIC Milan	4 IVAYLOV PATCHALIEV Daniel
5 KOJIC Nikola	5 KRIVOKAPIC Pavle	5 FRIGOLA NAVARRO Marc
6 ANDELIC Vuk	6 VUKSIC Milos	6 CASTRO FERNANDEZ Hugo
7 POZNANOVIC Zoran	7 VUKICEVIC Vladan	7 LOPEZ DUART Robert
8 UROSEVIC Viktor	8 KRIVOKAPIC Danilo	8 IBANEZ ALVAREZ Javier
9 KOVACEVIC Aleksandar	9 VUKICEVIC Lazar	9 PEREZ I RODRIGUEZ Jan
10 BRESCANSKI Bogdan	10 BASTRICA Nedo	10 DE LA CRUZ COLAPINTO Luca
11 STANIC Petar	11 SAMARDZIC Drasko	11 OTERO VILLALBA Javier
12 RADULOVIC Nikola Vuk	12 STUPAR Danilo	12 GOMILA FAIGES Biel
13 VIRIJEVIC Radosav	13 VUKOVIC Dusan	13 GARCIA PLANA Didac



## Pool standings

As of TUE 28 JUN 2022 at 19:08

Group A						Matches				Goals			
Rank		ESP	ITA	GRE	TUR	Played	Won	Lost	Ties	For	Against	Diff.	Class. Points
1	ESP	---	14 - 8	12 - 11	15 - 8	3	3	0	0	41	27	14	6
2	ITA	8 - 14	---	10 - 6	13 - 2	3	2	1	0	31	22	9	4
3	GRE	11 - 12	6 - 10	---	21 - 7	3	1	2	0	38	29	9	2
4	TUR	8 - 15	2 - 13	7 - 21	---	3	0	3	0	17	49	-32	0

Group B							Matches				Goals			
Rank		SRB	MNE	SLO	FRA	POR	Played	Won	Lost	Ties	For	Against	Diff.	Class. Point
1	SRB	---	9 - 8	22 - 6	18 - 7	16 - 3	4	4	0	0	65	24	41	8
2	MNE	8 - 9	---	11 - 6	16 - 8	23 - 4	4	3	1	0	58	27	31	6
3	SLO	6 - 22	6 - 11	---	11 - 7	18 - 5	4	2	2	0	41	45	-4	4
4	FRA	7 - 18	8 - 16	7 - 11	---	15 - 10	4	1	3	0	37	55	-18	2
5	POR	3 - 16	4 - 23	5 - 18	10 - 15	---	4	0	4	0	22	72	-50	0

## Games Schedule

Date	Start Time	Phase	Game	Teams	Result
FRI 24 JUN	10:00	Preliminary Group B	1	SLO - POR	18 - 5
	12:00	Preliminary Group B	2	FRA - MNE	8 - 16
	16:00	Preliminary Group A	3	GRE - ESP	11 - 12
	18:00	Preliminary Group A	4	TUR - ITA	2 - 13
SAT 25 JUN	10:00	Preliminary Group B	5	POR - FRA	10 - 15
	12:00	Preliminary Group B	6	SRB - SLO	22 - 6
SUN 26 JUN	10:00	Preliminary Group B	7	FRA - SRB	7 - 18
	12:00	Preliminary Group B	8	MNE - POR	23 - 4
	16:00	Preliminary Group A	9	ESP - ITA	14 - 8
	18:00	Preliminary Group A	10	GRE - TUR	21 - 7
MON 27 JUN	10:00	Preliminary Group B	11	SRB - MNE	9 - 8
	12:00	Preliminary Group B	12	SLO - FRA	11 - 7
TUE 28 JUN	10:00	Preliminary Group B	13	MNE - SLO	11 - 6
	12:00	Preliminary Group B	14	POR - SRB	3 - 16
	16:00	Preliminary Group A	15	ESP - TUR	15 - 8
	18:00	Preliminary Group A	16	ITA - GRE	10 - 6

### LEGEND

Class. Classification

Diff. Difference



## Brackets

As of THU 30 JUN 2022 at 14:11

### Semi-finals

### Finals

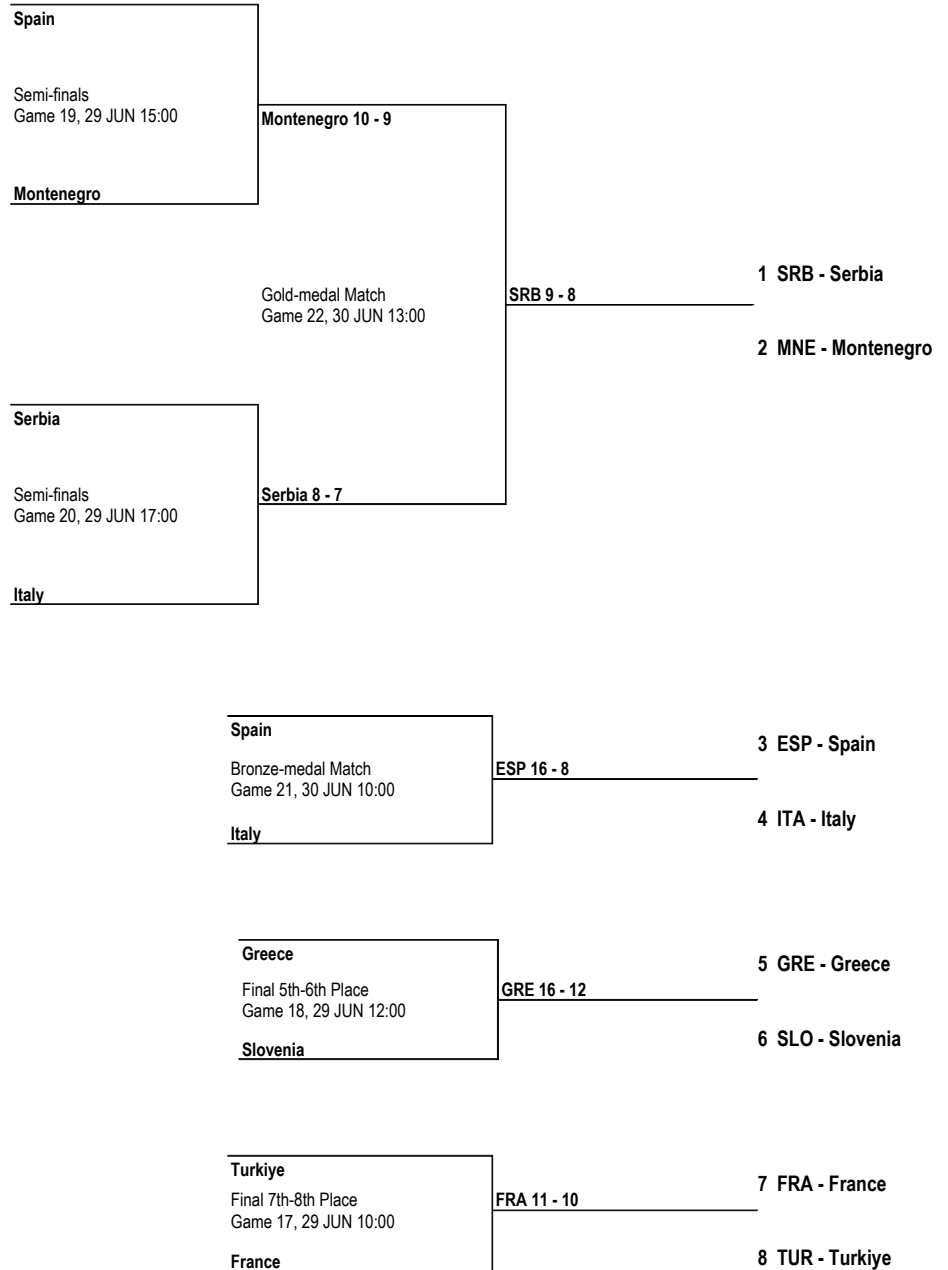



## Brackets

As of THU 30 JUN 2022 at 14:11

### LEGEND

**Ax** x (x=1-4) ranked team from group A    **Bx** x (x=1-4) ranked team from group B    **Class.** Classification    **Diff.** Difference  
**Lnn** Loser of match nn    **Wnn** Winner of match nn







FRI 24 JUN 2022

Results

Start Time 16:00

Greece (GRE) 11 - 12 Spain (ESP)

(2:2 2:4 4:2 3:4)

Referees: VIRIJEVIC Igor (SRB)  
DEHON Ghislain (FRA)

GRE - Greece (White)

No. Name	Goals/Shots									AS	TF	ST	BL	SP	Personal fouls				
	Total	%	A	C	X	6m	PS	CA	20C						20F	2EX	P	EX	
*1 DAMIGOS Theodoros																			
2 TOURKOMENIS Iason										1									
3 NIKOLAIDIS Georgios																3			S
4 TOTTIS Ioannis	1/3	33.3%	0/1		1/2					1	1								
5 ALMYRAS Andreas	2/6	33.3%	2/3		0/2	0/1						2		0/1	1	1		1	S
6 KASTRINAKIS Nikolaos	0/1	0.0%	0/1							1	1					2			
7 BITSAKOS Christos	2/3	66.7%	1/1		1/1	0/1					2			0/1		2		1	
8 DEFTERAIOS Fanourios Foivos	0/2	0.0%	0/1			0/1				1									
9 MYRILOS Anastasios	1/2	50.0%			1/2							1	1	0/1					
10 MATHIOPOULOS Konstantinos	2/4	50.0%	0/1		1/1	1/2						1		0/1					
11 SPACHITS Semir	1/1	100.0%	1/1									1							
12 KANDANOLEON Konstantinos	2/2	100.0%			2/2					1	1								
13 ALEIFTIRAS Christos																			
<b>Totals</b>	11/24	45.8%	4/9		6/10	1/5				2	6	7	1	0/4	6	3		2	2
No. Goalkeeper	Saves/Shots																		
	Total	%	A	C	X	6m	PS	CA											
*1 DAMIGOS Theodoros	8/20	40.0%	3/6	2/4	1/4	2/4	0/2												
13 ALEIFTIRAS Christos																			
<b>Totals</b>	8/20	40.0%	3/6	2/4	1/4	2/4	0/2												
<b>Head Coach</b>	MACHAIRAS Ilias																		
<b>Assistant Coach</b>																			
										Time Outs					0	0	1	1	
										Exclusion with Substitution							2		
										Exclusion w/Subst after 4 min.							0		

ESP - Spain (Blue)

No. Name	Goals/Shots									AS	TF	ST	BL	SP	Personal fouls					
	Total	%	A	C	X	6m	PS	CA	20C						20F	2EX	P	EX		
*1 TECLAS GUILLENA Xavier												2								
2 VILLAMAYOR I VILLAR Joan	0/1	0.0%		0/1						1		1		2/2		1				
3 GIL CEDO Gerard	0/3	0.0%	0/1		0/2					1		1		2/2		2				
4 IVAYLOV PATCHALIEV Daniel	0/2	0.0%			0/1	0/1									1	1				
5 FRIGOLA NAVARRO Marc	1/2	50.0%	0/1		1/1						1				1	2			S	
6 CASTRO FERNANDEZ Hugo	3/5	60.0%	0/1		1/2		2/2			1	1	1				2				
7 LOPEZ DUART Robert	5/8	62.5%	2/2		1/1	2/5					1	1				1				
8 IBANEZ ALVAREZ Javier															1	1				
9 PEREZ I RODRIGUEZ Jan	3/3	100.0%	1/1	2/2																
10 DE LA CRUZ COLAPINTO Luca													1							
11 OTERO VILLALBA Javier																				
12 GOMILA FAIGES Biel	0/2	0.0%		0/2												1				
13 GARCIA PLANA Didac																				
<b>Totals</b>	12/26	46.2%	3/6	2/5	3/7	2/6	2/2			3	3	6	1	4/4	3	11			1	
No. Goalkeeper	Saves/Shots																			
	Total	%	A	C	X	6m	PS	CA												
*1 TECLAS GUILLENA Xavier	6/17	35.3%	2/6		2/8	2/3														
13 GARCIA PLANA Didac																				
<b>Totals</b>	6/17	35.3%	2/6		2/8	2/3														
<b>Head Coach</b>	MARTIN LOZANO Jesus / SANCHEZ TORIL Javier																			
<b>Assistant Coach</b>																				
										Time Outs					0	0	1	1		
										Exclusion with Substitution							1			
										Exclusion w/Subst after 4 min.							0			



FRI 24 JUN 2022

## Results

Start Time 16:00

### Greece (GRE) 11 - 12 Spain (ESP)

(2:2 2:4 4:2 3:4)

Referees: VIRIJEVIC Igor (SRB)  
DEHON Ghislain (FRA)

Period	GRE - Greece											ESP - Spain															
	Score	EX	Goals(G)/Misses(M)										CT	Score	EX	Goals(G)/Misses(M)										CT	
			X		AA		FT		6mF		PS					X		AA		FT		6mF		PS			
G	M	G	M	G	M	G	M	G	M	G	M	G	M	G	M	G	M	G	M	G	M						
1st Quarter	2		1	2		1				1	2					2		1	1	1	3				1		
2nd Quarter	2		1	1	1	1					1					4		1		3					1		
3rd Quarter	4	1	2		2	2										2		1	1	1	1				2		
4th Quarter	3	1	2	1	1	1					1				1	4	1	2		2	1		1		2		
<b>Total</b>		2	6	4	4	5				1	4			1			1	3	4	5	6	1		1	4	2	

Match GRE - ESP													
Score	EX	Goals (G) / Misses (M)										CT	
		X		AA		FT		6mF		PS			
G	M	G	M	G	M	G	M	G	M	G	M	G	M
11	12	3	9	8	9	11	1		2	8	2		1

#### LEGEND

#	Number of possessions	%	Efficiency	20C	20" exclusions in centre	20F	20" exclusions in field
2EX	Double Exclusion	5m	5 Meter Shots	5mF	5 Meter Shots in the field	A	Action Shots
AA	All action shot (A, C, CA)	AS	Assists	BL	Blocked Shots	C	Centre Shots
CA	Counter Attack Shots	CT	Corner throws	EX	Exclusion (S = with substitution N = w	FT	Free throws
G	Goals	M	Misses	No.	Number	P	Penalty Fouls
TF	Turnover Fouls	TWPC	Technical Waterpolo Committee	X	Extra Player Shots	ST	Steals



FRI 24 JUN 2022

Results

Start Time 18:00

Turkey (TUR) 2 - 13 Italy (ITA)

(1:2 1:4 0:2 0:5)

Referees: HOMOVEC Matjaz (SLO)  
MOREIRA DA SILVA Eurico Simao (PO)

TUR - Turkey (White)

No. Name	Goals/Shots									AS	TF	ST	BL	SP	Personal fouls					
	Total	%	A	C	X	6m	PS	CA	20C						20F	2EX	P	EX		
*1 SAHIN Tugrul Alp																				
2 URLU Yaqiz	0/1	0.0%			0/1															
3 ERCIKDI Eren	0/3	0.0%	0/1		0/1	0/1				1	1	1				1				
4 CETIN Eren	0/1	0.0%				0/1							1							
5 KULOGLU Efe	1/6	16.7%			0/2	1/4							2	0/1		1				
6 KARABENLI Metin	0/1	0.0%	0/1									2				2				
7 EROKYAR Ege Mert													1	0/1		1				
8 BAKIR Baran	0/1	0.0%	0/1											0/1						
9 KOYUNCU Fevzi Emir												2	1						1	
10 CANER Guner Ege	1/5	20.0%	0/1		1/3	0/1										2		1	S	
11 SARAC Hayreddin Burak	0/1	0.0%			0/1											2				
12 INCI Berkan	0/1	0.0%				0/1							0/1							
13 ZOBU Kagan Yucel																				
<b>Totals</b>	2/20	10.0%	0/4		1/8	1/8				1	5	6	0/4		1	8		2	1	
No. Goalkeeper	Saves/Shots																			
	Total	%	A	C	X	6m	PS	CA												
*1 SAHIN Tugrul Alp	3/12	25.0%	2/7		1/3	0/1	0/1													
13 ZOBU Kagan Yucel	2/6	33.3%	1/2		0/2	0/1	1/1													
<b>Totals</b>	5/18	27.8%	3/9		1/5	0/2	1/2													
<b>Head Coach</b>	OLCAYTU Mehmet Alp																			
<b>Assistant Coach</b>																				

Time Outs	0	0	0	1
Exclusion with Substitution				1
Exclusion w/Subst after 4 min.				0

ITA - Italy (Blue)

No. Name	Goals/Shots									AS	TF	ST	BL	SP	Personal fouls					
	Total	%	A	C	X	6m	PS	CA	20C						20F	2EX	P	EX		
*1 VALLE Rocco																				
2 CORA Tommaso	3/5	60.0%	1/2		1/1	1/2						1	2			1				
3 BRAGANTINI Matteo	2/3	66.7%	1/2		1/1				1		1	1				2				
4 CAMMAROTA Riccardo	0/1	0.0%	0/1													2				
5 DE SIMON Riccardo	0/2	0.0%	0/2								2		1/1		1	2			S	
6 NENNI Angelo	2/2	100.0%	1/1		1/1				1			1								
7 NUZZO Andrea	1/3	33.3%	1/1			0/2										2				
8 ROCCHINO Mattia	1/2	50.0%				0/1	1/1		1	2	1		3/3		2	1			S	
9 GIACOMONE Giorgio	0/2	0.0%	0/2							1					1					
10 CASANOVA Nicolo'																				
11 TARASCIO Nicola	3/8	37.5%	1/3		1/1	1/3	0/1				1									
12 URBINATI Andrea	1/3	33.3%	1/2		0/1				1											
13 VALENZA Jason Danny																				
<b>Totals</b>	13/31	41.9%	6/16		4/5	2/8	1/2		3	4	6	4	4/4		5	9				2
No. Goalkeeper	Saves/Shots																			
	Total	%	A	C	X	6m	PS	CA												
*1 VALLE Rocco	10/12	83.3%	2/2		3/4	5/6														
13 VALENZA Jason Danny																				
<b>Totals</b>	10/12	83.3%	2/2		3/4	5/6														
<b>Head Coach</b>	ANGELINI Alberto																			
<b>Assistant Coach</b>																				

Time Outs	0	0	1	0
Exclusion with Substitution				2
Exclusion w/Subst after 4 min.				0



FRI 24 JUN 2022

## Results

Start Time 18:00

### Turkey (TUR) 2 - 13 Italy (ITA)

(1:2 1:4 0:2 0:5)

Referees: HOMOVEC Matjaz (SLO)  
MOREIRA DA SILVA Eurico Simao (PO)

Period	TUR - Turkey											ITA - Italy																
	Score	EX	Goals(G)/Misses(M)										CT	Score	EX	Goals(G)/Misses(M)										CT		
			X		AA		FT		6mF		PS					X		AA		FT		6mF		PS				
G	M	G	M	G	M	G	M	G	M	G	M	G	M	G	M	G	M	G	M	G	M	G	M					
1st Quarter	1			1		1		1		1		2				2		1		1		3		2				
2nd Quarter	1		1	4						1		1				4		2		1		3		1		3	1	
3rd Quarter	0			2						1		1				2				1		2		1		1	1	
4th Quarter	0	1								2						5	2	1				4	2					
<b>Total</b>		1	1	7				4	1	3		4					2	4	1		6	10		2	6	1	1	2

Match TUR - ITA													
Score	EX	Goals (G) / Misses (M)										CT	
		X		AA		FT		6mF		PS			
G	M	G	M	G	M	G	M	G	M	G	M	G	M
2	13	3	5	8	6	14	1	3	2	10	1	1	2

#### LEGEND

#	Number of possessions	%	Efficiency	20C	20" exclusions in centre	20F	20" exclusions in field
2EX	Double Exclusion	5m	5 Meter Shots	5mF	5 Meter Shots in the field	A	Action Shots
AA	All action shot (A, C, CA)	AS	Assists	BL	Blocked Shots	C	Centre Shots
CA	Counter Attack Shots	CT	Corner throws	EX	Exclusion (S = with substitution N = w	FT	Free throws
G	Goals	M	Misses	No.	Number	P	Penalty Fouls
TF	Turnover Fouls	TWPC	Technical Waterpolo Committee	X	Extra Player Shots	ST	Steals



SUN 26 JUN 2022

Results

Start Time 16:00

Spain (ESP) 14 - 8 Italy (ITA)

(2:1 3:3 5:2 4:2)

Referees: DURASKOVIC Andrija (MNE)  
VIRIJEVIC Igor (SRB)

ESP - Spain (White)

No. Name	Goals/Shots									AS	TF	ST	BL	SP	Personal fouls				
	Total	%	A	C	X	6m	PS	CA	20C						20F	2EX	P	EX	
*1 TECLAS GUILLENA Xavier												1							
2 VILLAMAYOR I VILLAR Joan	2/3	66.7%			1/1	0/1		1/1				1		2/3					
3 GIL CEDO Gerard	1/2	50.0%				0/1		1/1				1		1/1	1	1			
4 IVAYLOV PATCHALIEV Daniel	0/1	0.0%	0/1												1	1			
5 FRIGOLA NAVARRO Marc	1/2	50.0%				1/2				2								1	
6 CASTRO FERNANDEZ Hugo	4/6	66.7%	3/4			1/1	0/1			1	1				1				
7 LOPEZ DUART Robert	0/4	0.0%	0/2		0/1	0/1						2							
8 IBANEZ ALVAREZ Javier	3/4	75.0%			1/1	2/3				1		1				1			
9 PEREZ I RODRIGUEZ Jan											3		1						
10 DE LA CRUZ COLAPINTO Luca	1/1	100.0%		1/1														1	
11 OTERO VILLALBA Javier	1/1	100.0%	1/1									1				1			
12 GOMILA FAIGES Biel	1/1	100.0%			1/1					1									
13 GARCIA PLANA Didac																			
<b>Totals</b>	14/25	56.0%	4/8	1/1	3/4	4/9	0/1	2/2		4	5	7	1	3/4	3	4		2	
No. Goalkeeper	Saves/Shots																		
	Total	%	A	C	X	6m	PS	CA		Time Outs									
*1 TECLAS GUILLENA Xavier	10/18	55.6%	3/7	1/3	1/2	5/5	0/1		0 0 1 0										
13 GARCIA PLANA Didac									Exclusion with Substitution										
<b>Totals</b>	10/18	55.6%	3/7	1/3	1/2	5/5	0/1		Exclusion w/Subst after 4 min.										
<b>Head Coach</b>	SANCHEZ TORIL Javier																		
<b>Assistant Coach</b>	MARTIN LOZANO Jesus																		

ITA - Italy (Blue)

No. Name	Goals/Shots									AS	TF	ST	BL	SP	Personal fouls				
	Total	%	A	C	X	6m	PS	CA	20C						20F	2EX	P	EX	
*1 VALLE Rocco														0/1	1				
2 CORA Tommaso																			
3 BRAGANTINI Matteo	0/4	0.0%	0/2			0/2						1							
4 CAMMAROTA Riccardo										1									
5 DE SIMON Riccardo	2/2	100.0%	1/1				1/1			1				1/2	1	1			
6 NENNI Angelo	3/4	75.0%		2/3	1/1										1				
7 NUZZO Andrea	0/1	0.0%			0/1							1			2	1			S
8 ROCCHINO Mattia													1		2				
9 GIACOMONE Giorgio	0/1	0.0%			0/1														
10 CASANOVA Nicolo'	0/4	0.0%	0/1			0/3							1	0/1	1				
11 TARAMASCO Nicola	2/5	40.0%	2/2			0/3							1		1	1			
12 URBINATI Andrea	1/1	100.0%	1/1																
13 VALENZA Jason Danny																			
<b>Totals</b>	8/22	36.4%	4/7	2/3	1/3	0/8	1/1			2	2	3	1/4	7	4		1	1	
No. Goalkeeper	Saves/Shots																		
	Total	%	A	C	X	6m	PS	CA		Time Outs									
*1 VALLE Rocco	5/15	33.3%	2/3	0/1	0/2	2/6	1/1	0/2	0 0 0 0										
13 VALENZA Jason Danny	0/4	0.0%	0/3		0/1				Exclusion with Substitution										
<b>Totals</b>	5/19	26.3%	2/6	0/1	0/3	2/6	1/1	0/2	Exclusion w/Subst after 4 min.										
<b>Head Coach</b>	ANGELINI Alberto																		
<b>Assistant Coach</b>	BETTINI Daniele																		



SUN 26 JUN 2022

### Results

Start Time 16:00

## Spain (ESP) 14 - 8 Italy (ITA)

(2:1 3:3 5:2 4:2)

**Referees:** DURASKOVIC Andrija (MNE)  
VIRIJEVIC Igor (SRB)

Period	ESP - Spain											ITA - Italy														
	Score	EX	Goals(G)/Misses(M)										CT	Score	EX	Goals(G)/Misses(M)										CT
			X		AA		FT		6mF		PS					X		AA		FT		6mF		PS		
G	M	G	M	G	M	G	M	G	M	G	M	G	M	G	M	G	M	G	M	G	M					
1st Quarter	2		1		1	1					1		1			1		1		1		2				
2nd Quarter	3		1		2	2								1	2	1					2	1				
3rd Quarter	5			1	1	1				4	2					2	1			2						
4th Quarter	4		1		3			1		1						2	2			2		2				
<b>Total</b>			3	1	7	4		1	4	4		1		1	2	6	4		1	7	1	4				

Match ESP - ITA													
Score	EX	Goals (G) / Misses (M)										CT	
		X		AA		FT		6mF		PS			
G	M	G	M	G	M	G	M	G	M	G	M		
14	8	1		4	3	13	8	2	4	11	1	1	4

#### LEGEND

#	Number of possessions	%	Efficiency	20C	20" exclusions in centre	20F	20" exclusions in field
2EX	Double Exclusion	5m	5 Meter Shots	5mF	5 Meter Shots in the field	A	Action Shots
AA	All action shot (A, C, CA)	AS	Assists	BL	Blocked Shots	C	Centre Shots
CA	Counter Attack Shots	CT	Corner throws	EX	Exclusion (S = with substitution N = w	FT	Free throws
G	Goals	M	Misses	No.	Number	P	Penalty Fouls
TF	Turnover Fouls	TWPC	Technical Waterpolo Committee	X	Extra Player Shots	ST	Steals



SUN 26 JUN 2022

## Results

Start Time 18:00

### Greece (GRE) 21 - 7 Turkey (TUR)

(4:2 4:3 7:1 6:1)

Referees: MOREIRA DA SILVA Eurico Simao (PO)  
HOMOVEC Matjaz (SLO)

#### GRE - Greece (White)

No. Name	Goals/Shots									AS	TF	ST	BL	SP	Personal fouls				
	Total	%	A	C	X	6m	PS	CA	20C						20F	2EX	P	EX	
1 DAMIGOS Theodoros																			
2 TOURKOMENIS Iason	0/2	0.0%			0/1	0/1						1							1
3 NIKOLAIDIS Georgios												3	1						2
4 TOTTIS Ioannis	2/2	100.0%	1/1		1/1							2	1						
5 ALMYRAS Andreas	3/5	60.0%	1/2		1/1	0/1		1/1		1	2			1/1					1
6 KASTRINAKIS Nikolaos	3/4	75.0%	0/1			1/1		2/2			2								1
7 BITSAKOS Christos	3/6	50.0%	1/3			1/2	1/1				2			1/1					1
8 DEFTERAIOS Fanourios Foivos	2/2	100.0%			1/1			1/1		1	1			1/1					1
9 MYRILOS Anastasios	1/2	50.0%			1/2						3								
10 MATHIOPOULOS Konstantinos	1/3	33.3%	0/2		1/1					1				1/1					1
11 SPACHITS Semir	4/4	100.0%	1/1	1/1	1/1	1/1				1		1							1
12 KANDANOLEON Konstantinos	2/2	100.0%		1/1	1/1					1									
*13 ALEIFTIRAS Christos																			
<b>Totals</b>	21/32	65.6%	4/10	2/2	7/9	3/6	1/1	4/4		1	8	12	3	4/4		5	4		1
No. Goalkeeper	Saves/Shots																		
1 DAMIGOS Theodoros																			
*13 ALEIFTIRAS Christos	10/17	58.8%	3/3	0/1	2/2	5/8	0/2	0/1											
<b>Totals</b>	10/17	58.8%	3/3	0/1	2/2	5/8	0/2	0/1											
<b>Head Coach</b>	MACHAIRAS Ilias																		
<b>Assistant Coach</b>	ANDREAKOS Teo																		

Time Outs	0	0	0	0
Exclusion with Substitution				0
Exclusion w/Subst after 4 min.				0

#### TUR - Turkey (Blue)

No. Name	Goals/Shots									AS	TF	ST	BL	SP	Personal fouls				
	Total	%	A	C	X	6m	PS	CA	20C						20F	2EX	P	EX	
1 SAHIN Tugrul Alp																			
2 URLU Yagiz											2								
3 ERCIKDI Eren	2/6	33.3%			0/1	1/4	1/1					1				1	1		
4 CETIN Eren	0/2	0.0%				0/2								0/1		1			
5 KULOGLU Efe																			
6 KARABENLI Metin	0/1	0.0%				0/1										1	1		
7 EROKYAR Ege Mert	0/2	0.0%	0/1			0/1							1	0/2					
8 BAKIR Baran	1/1	100.0%						1/1						0/1					
9 KOYUNCU Fevzi Emir	2/2	100.0%		1/1			1/1												1
10 CANER Guner Ege	1/6	16.7%	0/1		0/2	1/3				1		1				1	2		S
11 SARAC Hayreddin Burak	1/1	100.0%				1/1										1			
12 INCI Berkan	0/1	0.0%	0/1													1			
*13 ZOBU Kagan Yucel																			
<b>Totals</b>	7/22	31.8%	0/3	1/1	0/3	3/12	2/2	1/1		1	2	2	2	0/4		4	6		1 1
No. Goalkeeper	Saves/Shots																		
1 SAHIN Tugrul Alp	1/4	25.0%	1/3			0/1													
*13 ZOBU Kagan Yucel	3/21	14.3%	1/3	0/2	2/9	0/2	0/1	0/4											
<b>Totals</b>	4/25	16.0%	2/6	0/2	2/9	0/3	0/1	0/4											
<b>Head Coach</b>	OLCAYTU Mehmet Alp																		
<b>Assistant Coach</b>	BATMAZ Ali / KAHRAMAN Ozgur																		

Time Outs	0	1	0	1
Exclusion with Substitution				1
Exclusion w/Subst after 4 min.				0



SUN 26 JUN 2022

### Results

Start Time 18:00

## Greece (GRE) 21 - 7 Turkey (TUR)

(4:2 4:3 7:1 6:1)

Referees: MOREIRA DA SILVA Eurico Simao (PO)  
HOMOVEC Matjaz (SLO)

Period	GRE - Greece											TUR - Turkey														
	Score	EX	Goals(G)/Misses(M)										CT	Score	EX	Goals(G)/Misses(M)										CT
			X		AA		FT		6mF		PS					X		AA		FT		6mF		PS		
G	M	G	M	G	M	G	M	G	M	G	M	G	M	G	M	G	M	G	M	G	M	G	M			
1st Quarter	4		1	1	2	1						1			2							2	4			
2nd Quarter	4		3	1		1					1				3		1	1				1	2	1	2	
3rd Quarter	7		1		5	2				1	2			1		1	1	1								
4th Quarter	6		2		3	2				1	1		1	1				1				3	1			
<b>Total</b>			7	2	10	6				3	3	1	1	1		3	2	3				3	9	2		

Match GRE - TUR													
Score	EX	Goals (G) / Misses (M)										CT	
		X		AA		FT		6mF		PS			
G	M	G	M	G	M	G	M	G	M	G	M		
21	7	1		7	5	12	9			6	12	3	3

#### LEGEND

#	Number of possessions	%	Efficiency	20C	20" exclusions in centre	20F	20" exclusions in field
2EX	Double Exclusion	5m	5 Meter Shots	5mF	5 Meter Shots in the field	A	Action Shots
AA	All action shot (A, C, CA)	AS	Assists	BL	Blocked Shots	C	Centre Shots
CA	Counter Attack Shots	CT	Corner throws	EX	Exclusion (S = with substitution N = w	FT	Free throws
G	Goals	M	Misses	No.	Number	P	Penalty Fouls
TF	Turnover Fouls	TWPC	Technical Waterpolo Committee	X	Extra Player Shots	ST	Steals





TUE 28 JUN 2022

**Results**

Start Time 16:00

**Spain (ESP) 15 - 8 Turkiye (TUR)**

(6:3 1:2 4:2 4:1)

**Referees:** HOMOVEC Matjaz (SLO)  
DEHON Ghislain (FRA)

**ESP - Spain (White)**

No. Name	Goals/Shots									AS	TF	ST	BL	SP	Personal fouls				
	Total	%	A	C	X	6m	PS	CA	20C						20F	2EX	P	EX	
*1 TECLAS GUILLENA Xavier																			1
2 VILLAMAYOR I VILLAR Joan	2/2	100.0%	1/1		1/1					2									
3 GIL CEDO Gerard	3/5	60.0%	1/2			0/1	1/1	1/1		1				3/4					1
4 IVAYLOV PATCHALIEV Daniel	2/3	66.7%	2/3								1	1							2
5 FRIGOLA NAVARRO Marc	3/6	50.0%	2/2					1/4		1		1							1
6 CASTRO FERNANDEZ Hugo	2/5	40.0%	0/2	0/1	1/1	1/1									1				
7 LOPEZ DUART Robert	2/4	50.0%			0/1	1/2	1/1			1		4	1						1
8 IBANEZ ALVAREZ Javier																		2	1 S
9 PEREZ I RODRIGUEZ Jan	1/3	33.3%	0/1	1/1	0/1							1							1
10 DE LA CRUZ COLAPINTO Luca																			
11 OTERO VILLALBA Javier										1	1								1
12 GOMILA FAIGES Biel										1									
13 GARCIA PLANA Didac										1									
<b>Totals</b>	15/28	53.6%	6/11	1/2	2/4	3/8	2/2	1/1		5	4	8	1	3/4	1	8		3	1
No. Goalkeeper	Saves/Shots									Time Outs					0	0	0	0	
	Total	%	A	C	X	6m	PS	CA		Exclusion with Substitution					1				
*1 TECLAS GUILLENA Xavier	2/5	40.0%	1/2			1/2	0/1			Exclusion w/Subst after 4 min.					0				
13 GARCIA PLANA Didac	7/12	58.3%	2/3		1/1	4/5	0/1	0/2											
<b>Totals</b>	9/17	52.9%	3/5		1/1	5/7	0/2	0/2											
<b>Head Coach</b>	SANCHEZ TORIL Javier																		
<b>Assistant Coach</b>	MARTIN LOZANO Jesus																		

**TUR - Turkiye (Blue)**

No. Name	Goals/Shots									AS	TF	ST	BL	SP	Personal fouls				
	Total	%	A	C	X	6m	PS	CA	20C						20F	2EX	P	EX	
1 SAHIN Tugrul Alp																			
2 URLU Yagiz																			
3 ERCIKDI Eren	1/5	20.0%	0/2		0/1		1/2			2			1						1
4 CETIN Eren																			1
5 KULOGLU Efe	2/5	40.0%	1/1			0/3		1/1				1		1/2					
6 KARABENLI Metin										1	1	1							2
7 EROKYAR Ege Mert	0/1	0.0%	0/1									1		0/1					1
8 BAKIR Baran																		1	1
9 KOYUNCU Fevzi Emir												1							1
10 CANER Guner Ege	5/9	55.6%	1/1			2/6	1/1	1/1		1		1	0/1						1
11 SARAC Hayreddin Burak	0/1	0.0%	0/1																
12 INCI Berkan	0/1	0.0%				0/1				2									
*13 ZOBU Kağan Yücel																			
<b>Totals</b>	8/22	36.4%	2/6		0/1	2/10	2/3	2/2		6	4	3	1/4	5	2			2	
No. Goalkeeper	Saves/Shots									Time Outs					0	1	0	1	
	Total	%	A	C	X	6m	PS	CA		Exclusion with Substitution					0				
1 SAHIN Tugrul Alp	0/4	0.0%	0/2			0/2				Exclusion w/Subst after 4 min.					0				
*13 ZOBU Kağan Yücel	1/12	8.3%	1/5	0/1	0/2	0/1	0/2	0/1											
<b>Totals</b>	1/16	6.3%	1/7	0/1	0/2	0/3	0/2	0/1											
<b>Head Coach</b>	OLCAYTU Mehmet Alp																		
<b>Assistant Coach</b>	BATMAZ Ali / KAHRAMAN Ozgur																		



TUE 28 JUN 2022

### Results

Start Time 16:00

## Spain (ESP) 15 - 8 Turkiye (TUR)

(6:3 1:2 4:2 4:1)

Referees: HOMOVEC Matjaz (SLO)  
DEHON Ghislain (FRA)

Period	ESP - Spain											TUR - Turkiye														
	Score	EX	Goals(G)/Misses(M)										CT	Score	EX	Goals(G)/Misses(M)										CT
			X		AA		FT		6mF		PS					X		AA		FT		6mF		PS		
G	M	G	M	G	M	G	M	G	M	G	M	G	M	G	M	G	M	G	M	G	M					
1st Quarter	6		1		4	1					2	1				3			1	1		1	1	1		
2nd Quarter	1				2						1	1				2			1	2			2			
3rd Quarter	4			2	2					2						2			1	2		2	1			
4th Quarter	4	1	1		2	3				1	2					1				1			3	1	1	
<b>Total</b>		1	2	2	8	6				3	5	2				1	4	4		2	2	6	2	1		

Match ESP - TUR													
Score	EX	Goals (G) / Misses (M)										CT	
		X		AA		FT		6mF		PS			
G	M	G	M	G	M	G	M	G	M	G	M	G	M
15	8	1	2	3	12	10	2	5	11	4	1		

#### LEGEND

#	Number of possessions	%	Efficiency	20C	20" exclusions in centre	20F	20" exclusions in field
2EX	Double Exclusion	5m	5 Meter Shots	5mF	5 Meter Shots in the field	A	Action Shots
AA	All action shot (A, C, CA)	AS	Assists	BL	Blocked Shots	C	Centre Shots
CA	Counter Attack Shots	CT	Corner throws	EX	Exclusion (S = with substitution N = w	FT	Free throws
G	Goals	M	Misses	No.	Number	P	Penalty Fouls
TF	Turnover Fouls	TWPC	Technical Waterpolo Committee	X	Extra Player Shots	ST	Steals



TUE 28 JUN 2022

Results

Start Time 18:00

Italy (ITA) 10 - 6 Greece (GRE)

(1:1 4:2 3:2 2:1)

Referees: MOREIRA DA SILVA Eurico Simao (PO)  
VIRIJEVIC Igor (SRB)

ITA - Italy (White)

No. Name	Goals/Shots									AS	TF	ST	BL	SP	Personal fouls						
	Total	%	A	C	X	6m	PS	CA	20C						20F	2EX	P	EX			
*1 VALLE Rocco												3									
2 CORA Tommaso													1			1					
3 BRAGANTINI Matteo	3/7	42.9%	0/2		1/3	2/2				1		2				1					
4 CAMMAROTA Riccardo	0/1	0.0%		0/1												3			S		
5 DE SIMON Riccardo	0/3	0.0%	0/1			0/2					1	2				2					
6 NENNI Angelo	3/5	60.0%		2/4	1/1						1					2					
7 NUZZO Andrea	1/5	20.0%	1/2			0/3										1		1			
8 ROCCHINO Mattia	2/6	33.3%	0/3		2/3							2		3/3							
9 GIACOMONE Giorgio										1		2									
10 CASANOVA Nicolo'														0/1							
11 TARAMASCO Nicola	1/1	100.0%				1/1				1	1										
12 URBINATI Andrea																2					
13 VALENZA Jason Danny																					
<b>Totals</b>	10/28	35.7%	1/8	2/5	4/7	3/8				1	4	10	3	3/4	8	4		1	1		
No. Goalkeeper	Saves/Shots									Time Outs											
	Total	%	A	C	X	6m	PS	CA													
*1 VALLE Rocco	1/7	14.3%	0/1	0/2	0/1	1/2	0/1											0	0	1	0
13 VALENZA Jason Danny																				1	
<b>Totals</b>	1/7	14.3%	0/1	0/2	0/1	1/2	0/1													0	0
<b>Head Coach</b>	ANGELINI Alberto																				
<b>Assistant Coach</b>	BETTINI Daniele																				

GRE - Greece (Blue)

No. Name	Goals/Shots									AS	TF	ST	BL	SP	Personal fouls						
	Total	%	A	C	X	6m	PS	CA	20C						20F	2EX	P	EX			
*1 DAMIGOS Theodoros												1									
2 TOURKOMENIS Iason														0/1							
3 NIKOLAIDIS Georgios												1				1					
4 TOTTIS Ioannis	0/1	0.0%			0/1																
5 ALMYRAS Andreas	2/6	33.3%	1/1		0/1	0/3	1/1					1		0/1							
6 KASTRINAKIS Nikolaos										1			1	0/1	1	2				S	
7 BITSAKOS Christos	0/1	0.0%				0/1				1		1		1/1		1					
8 DEFTERAIOS Fanourios Foivos	1/2	50.0%				1/2						2				2					
9 MYRILOS Anastasios	1/2	50.0%		1/1	0/1						4							1			
10 MATHIOPOULOS Konstantinos	0/1	0.0%				0/1						2	1			3				S	
11 SPACHITS Semir	0/3	0.0%			0/1	0/1		0/1		1						1					
12 KANDANOLEON Konstantinos	2/2	100.0%		1/1	1/1					2	1										
13 ALEIFTIRAS Christos																					
<b>Totals</b>	6/18	33.3%	1/1	2/2	1/5	1/8	1/1	0/1		1	8	9	2	1/4	4	8				2	
No. Goalkeeper	Saves/Shots									Time Outs											
	Total	%	A	C	X	6m	PS	CA													
*1 DAMIGOS Theodoros	10/20	50.0%	6/7	2/4	1/5	1/4												0	0	0	2
13 ALEIFTIRAS Christos																				2	
<b>Totals</b>	10/20	50.0%	6/7	2/4	1/5	1/4														0	0
<b>Head Coach</b>	MACHAIRAS Ilias																				
<b>Assistant Coach</b>	ANDREAKOS Teo																				



TUE 28 JUN 2022

## Results

Start Time 18:00

### Italy (ITA) 10 - 6 Greece (GRE)

(1:1 4:2 3:2 2:1)

**Referees:** MOREIRA DA SILVA Eurico Simao (PO)  
VIRIJEVIC Igor (SRB)

Period	ITA - Italy											GRE - Greece														
	Score	EX	Goals(G)/Misses(M)										CT	Score	EX	Goals(G)/Misses(M)										CT
			X		AA		FT		6mF		PS					X		AA		FT		6mF		PS		
G	M	G	M	G	M	G	M	G	M	G	M	G	M	G	M	G	M	G	M	G	M					
1st Quarter	1		1	2		3					2		1			1	1					1				
2nd Quarter	4		2					1	2	1			2			1	1	1		1	1	1				
3rd Quarter	3	1		1	2	4				1			2		1	1			2		1	1				
4th Quarter	2		1		1	3		1				1	1	2		1	1				1					
<b>Total</b>		1	4	3	3	10		2	3	3		2	2	1	4	3	1		3	1	4	1				

Match ITA - GRE												
Score	EX	Goals (G) / Misses (M)										CT
		X		AA		FT		6mF		PS		
G	M	G	M	G	M	G	M	G	M	G	M	
10	6	3		5	7	6	11	5	4	7	1	2

#### LEGEND

#	Number of possessions	%	Efficiency	20C	20" exclusions in centre	20F	20" exclusions in field
2EX	Double Exclusion	5m	5 Meter Shots	5mF	5 Meter Shots in the field	A	Action Shots
AA	All action shot (A, C, CA)	AS	Assists	BL	Blocked Shots	C	Centre Shots
CA	Counter Attack Shots	CT	Corner throws	EX	Exclusion (S = with substitution N = w	FT	Free throws
G	Goals	M	Misses	No.	Number	P	Penalty Fouls
TF	Turnover Fouls	TWPC	Technical Waterpolo Committee	X	Extra Player Shots	ST	Steals



FRI 24 JUN 2022

## Results

Start Time 10:00

## Slovenia (SLO) 18 - 5 Portugal (POR)

(5:0 5:1 4:2 4:2)

Referees: PETRONILLI Arnaldo (ITA)  
TAYLAN Emanuel Manol (TUR)

## SLO - Slovenia (White)

No. Name	Goals/Shots									AS	TF	ST	BL	SP	Personal fouls				
	Total	%	A	C	X	6m	PS	CA	20C						20F	2EX	P	EX	
*1 OSEL Nejc										1									
2 CANC Mattia Bernard	2/4	50.0%	1/2	0/1				1/1		1		1		1/2					
3 FICUR Gasper	2/3	66.7%	0/1	1/1	1/1						1			0/1					
4 SELJAK Jurij	1/2	50.0%							1/2	1									
5 LAH Jasa	6/6	100.0%	4/4	1/1				1/1				1	1				2		
6 KACIC Tim	1/2	50.0%	0/1						1/1			1					1		
7 RAJLIC Nikola	2/3	66.7%	2/3								1								
8 PAUNOVIC Aleksander	2/4	50.0%	0/1						2/3	1							1		
9 CARNI Jost	0/1	0.0%						0/1		1	1								
10 CERAR Aleksander	1/5	20.0%	0/3				0/1		1/1				1	1/1					
11 GLIGOROVSKI Lukas	1/3	33.3%	0/1				0/1	1/1				1							1
12 KODER Samo											1								
13 LONCAREVIC Alan																			
<b>Totals</b>	<b>18/33</b>	<b>54.5%</b>	<b>7/16</b>	<b>2/3</b>	<b>1/1</b>	<b>0/2</b>	<b>3/4</b>	<b>5/7</b>		<b>5</b>	<b>4</b>	<b>4</b>	<b>2</b>	<b>2/4</b>		<b>4</b>		<b>1</b>	
No. Goalkeeper	Saves/Shots									Time Outs									
	Total	%	A	C	X	6m	PS	CA		0   0   1   0									
*1 OSEL Nejc	6/7	85.7%	2/2		1/1	3/4				Exclusion with Substitution 0									
13 LONCAREVIC Alan	8/12	66.7%	3/4	2/2	0/1	3/4	0/1			Exclusion w/Subst after 4 min. 0									
<b>Totals</b>	<b>14/19</b>	<b>73.7%</b>	<b>5/6</b>	<b>2/2</b>	<b>1/2</b>	<b>6/8</b>	<b>0/1</b>												
<b>Head Coach</b>	SKOF Jure																		
<b>Assistant Coach</b>																			

## POR - Portugal (Blue)

No. Name	Goals/Shots									AS	TF	ST	BL	SP	Personal fouls				
	Total	%	A	C	X	6m	PS	CA	20C						20F	2EX	P	EX	
1 PEREIRA PIRES Joao Pedro												2							
2 CARVALHO DIAS Antonio										1									
3 VELOSO SANTOS Rodrigo										2		1	1/1			2			
4 GONCALVES PINA Diogo Manuel	0/2	0.0%					0/2			1								1	
5 DE OLIVEIRA FONTANA Marco	0/2	0.0%	0/1				0/1							0/1	1				
6 ROSA INACIO António Guilherme																			
7 ORNELLAS SANTIAGO Diogo	1/10	10.0%	0/4	0/1	0/2	1/3		1/1				1						2	
8 RODRIGUES Afonso																			
9 GONCALVES FONTELAS Guilherme	0/3	0.0%	0/1				0/2							1/1					
10 FERNANDES MARTINS Rodrigo	0/1	0.0%		0/1						1		1							
11 FRAGOSO PEREIRA Antonio Daniel	0/2	0.0%	0/2									1				1		1	
12 GUERREIRO MOREIRA Joao	4/9	44.4%	1/4		1/1	1/3	1/1			1		1	0/1					1	
*13 VITAL SIMOES JUHOS Vasco Diniz																			
<b>Totals</b>	<b>5/29</b>	<b>17.2%</b>	<b>1/12</b>	<b>0/2</b>	<b>1/3</b>	<b>2/11</b>	<b>1/1</b>			<b>6</b>	<b>3</b>	<b>4</b>	<b>2/4</b>	<b>1</b>	<b>3</b>		<b>5</b>		
No. Goalkeeper	Saves/Shots									Time Outs									
	Total	%	A	C	X	6m	PS	CA		0   1   0   1									
1 PEREIRA PIRES Joao Pedro	1/9	11.1%	1/6				0/2	0/1		Exclusion with Substitution 0									
*13 VITAL SIMOES JUHOS Vasco Diniz	6/16	37.5%	3/5	1/3	0/1	1/1	0/1	1/5		Exclusion w/Subst after 4 min. 0									
<b>Totals</b>	<b>7/25</b>	<b>28.0%</b>	<b>4/11</b>	<b>1/3</b>	<b>0/1</b>	<b>1/1</b>	<b>0/3</b>	<b>1/6</b>											
<b>Head Coach</b>	SOARES COSTA Fernando Jorge																		
<b>Assistant Coach</b>																			





FRI 24 JUN 2022

Results

Start Time 12:00

France (FRA) 8 - 16 Montenegro (MNE)

(2:4 2:4 1:4 3:4)

Referees: SPANOUDIS Grigorios (GRE)  
JIMENEZ TURNES Sergio (ESP)

FRA - France (White)

No. Name	Goals/Shots									AS	TF	ST	BL	SP	Personal fouls					
	Total	%	A	C	X	6m	PS	CA	20C						20F	2EX	P	EX		
*1 DUTET Corentin																				
2 CHAPLET Sandro																				1
3 BLIEK PANNETIER Maxime																1				
4 RODRIGUES Clement	4/5	80.0%	2/3		2/2												1			
5 LE GOFF Armand	0/2	0.0%				0/1	0/1					2								
6 ROUSSEL Evan	0/2	0.0%			0/1	0/1								0/1			2			
7 DE NARDI Pablo	0/1	0.0%				0/1				1		1				2	1			S
8 ONDO METHOGO Leandre	0/2	0.0%	0/2											2/3		1			1	
9 MARCENAT Melvyn	0/1	0.0%		0/1							2					1				
10 MATHIEU Manatea										1							2			
11 MAS Mathis	4/8	50.0%	1/1	0/1	0/1	0/2		3/3			1	1	1				1			
12 MEHDI Adam																	1			
13 VOIGT Yvano												1								
<b>Totals</b>	<b>8/21</b>	<b>38.1%</b>	<b>3/6</b>	<b>0/2</b>	<b>2/4</b>	<b>0/5</b>	<b>0/1</b>	<b>3/3</b>		<b>2</b>	<b>3</b>	<b>5</b>	<b>1</b>	<b>2/4</b>		<b>5</b>	<b>8</b>		<b>2</b>	<b>1</b>
No. Goalkeeper	Saves/Shots									Time Outs					0	0	1	1		
	Total	%	A	C	X	6m	PS	CA		Exclusion with Substitution					1					
*1 DUTET Corentin	6/14	42.9%	4/7		1/5	1/1	0/1			Exclusion w/Subst after 4 min.					0					
13 VOIGT Yvano	5/13	38.5%	2/2		0/3	3/4	0/1	0/3							0					
<b>Totals</b>	<b>11/27</b>	<b>40.7%</b>	<b>6/9</b>		<b>1/8</b>	<b>4/5</b>	<b>0/2</b>	<b>0/3</b>												
<b>Head Coach</b>	DONSIMONI Alexandre																			
<b>Assistant Coach</b>	GHESQUIERE Jonathan																			

MNE - Montenegro (Blue)

No. Name	Goals/Shots									AS	TF	ST	BL	SP	Personal fouls					
	Total	%	A	C	X	6m	PS	CA	20C						20F	2EX	P	EX		
*1 BJELICA Andrija																				
2 VUCKOVIC Balsa	3/5	60.0%	1/2		2/2	0/1								1/1			1			
3 DRAGOVIC Danilo										1	1	1				1	1			
4 NIKALJEVIC Milan	1/2	50.0%				0/1		1/1					1	0/1		1				
5 KRIVOKAPIC Pavle	1/3	33.3%	0/1			0/1		1/1				1				1				
6 VUKSIC Milos	0/2	0.0%	0/2											0/1						
7 VUKICEVIC Vladan	3/4	75.0%	0/1		1/1	1/1	1/1			2		2								
8 KRIVOKAPIC Danilo	1/1	100.0%					1/1							1/1			1			
9 VUKICEVIC Lazar	5/7	71.4%	2/3		2/3			1/1			1	1					1			
10 BASTRICA Nedo	2/3	66.7%			2/3					1	2					1				
11 SAMARDZIC Drasko	0/1	0.0%				0/1				1			1						1	
12 STUPAR Danilo	0/2	0.0%	0/1			0/1					2	1								
13 VUKOVIC Dusan																				
<b>Totals</b>	<b>16/30</b>	<b>53.3%</b>	<b>3/10</b>		<b>7/9</b>	<b>1/6</b>	<b>2/2</b>	<b>3/3</b>		<b>4</b>	<b>6</b>	<b>6</b>	<b>3</b>	<b>2/4</b>		<b>3</b>	<b>5</b>		<b>1</b>	
No. Goalkeeper	Saves/Shots									Time Outs					0	0	1	0		
	Total	%	A	C	X	6m	PS	CA		Exclusion with Substitution					0					
*1 BJELICA Andrija	5/10	50.0%	1/3		1/2	2/2	1/1	0/2		Exclusion w/Subst after 4 min.					0					
13 VUKOVIC Dusan	2/5	40.0%	0/1	1/1	0/1	1/1		0/1							0					
<b>Totals</b>	<b>7/15</b>	<b>46.7%</b>	<b>1/4</b>	<b>1/1</b>	<b>1/3</b>	<b>3/3</b>	<b>1/1</b>	<b>0/3</b>												
<b>Head Coach</b>	CIROVIC Milan / MIJANOVIC Nikola / LOMPAR Vido / IVANOVSKI Dusan																			
<b>Assistant Coach</b>																				







SAT 25 JUN 2022

Start Time 10:00

## Results

## Portugal (POR) 10 - 15 France (FRA)

(2:2 1:4 3:4 4:5)

Referees: SPANOUDIS Grigorios (GRE)  
TAYLAN Emanuel Manol (TUR)

## POR - Portugal (White)

No. Name	Goals/Shots									AS	TF	ST	BL	SP	Personal fouls				
	Total	%	A	C	X	6m	PS	CA	20C						20F	2EX	P	EX	
*1 PEREIRA PIRES Joao Pedro												1							
2 CARVALHO DIAS Antonio	0/1	0.0%	0/1									1				1		2	S
3 RODRIGUES Afonso	1/3	33.3%	1/2	0/1									1	0/3		2		1	
4 GONCALVES PINA Diogo Manuel	1/6	16.7%	1/3		0/2	0/1													
5 DE OLIVEIRA FONTANA Marco	1/1	100.0%	1/1											1/1		1			
6 ROSA INACIO António Guilherme																			
7 ORNELLAS SANTIAGO Diogo	2/9	22.2%	0/1		1/4	0/3	1/1			1		3				2			
8 VELOSO SANTOS Rodrigo																			
9 GONCALVES FONTELAS Guilherme	2/2	100.0%	1/1				1/1											1	
10 FERNANDES MARTINS Rodrigo																			
11 FRAGOSO PEREIRA Antonio Daniel												1				1	2		S
12 GUERREIRO MOREIRA Joao	3/4	75.0%				2/3		1/1											
13 VITAL SIMOES JUHOS Vasco Diniz																			
<b>Totals</b>	10/26	38.5%	4/9	0/1	1/6	2/7	2/2	1/1		1	3	4	1/4		3	6		4	2
No. Goalkeeper	Saves/Shots																		
	Total	%	A	C	X	6m	PS	CA		Time Outs									
*1 PEREIRA PIRES Joao Pedro	5/11	45.5%	1/1		0/1	1/2	1/2	2/5		0 1 1 0									
13 VITAL SIMOES JUHOS Vasco Diniz	2/11	18.2%	1/4	0/2	0/2	1/2	0/1		Exclusion with Substitution 2										
<b>Totals</b>	7/22	31.8%	2/5	0/2	0/3	2/4	1/3	2/5	Exclusion w/Subst after 4 min. 0										
<b>Head Coach</b>	REVEZ Gonçalo Abrunhosa																		
<b>Assistant Coach</b>	MATOS MAGALHAES Ana Patrícia																		

## FRA - France (Blue)

No. Name	Goals/Shots									AS	TF	ST	BL	SP	Personal fouls				
	Total	%	A	C	X	6m	PS	CA	20C						20F	2EX	P	EX	
*1 DUTET Corentin																			
2 CHAPLET Sandro	1/1	100.0%	1/1																
3 BLIEK PANNETIER Maxime	1/3	33.3%	0/2		1/1					1	1					1		1	
4 RODRIGUES Clement	1/4	25.0%			0/2		0/1	1/1			2	3	1			1	2		S
5 LE GOFF Armand	1/1	100.0%			1/1														
6 ROUSSEL Evan	1/5	20.0%	0/3					1/2			1	4				2			
7 DE NARDI Pablo	0/3	0.0%	0/1		0/1	0/1					2	2				1		1	
8 ONDO METHOGO Leandre	0/4	0.0%	0/1			0/2		0/1				2	1/2			1			
9 MARCENAT Melvyn	2/3	66.7%	1/1	1/2								1				1			
10 MATHIEU Manatea	2/3	66.7%	1/1			1/2						2	2/2			1			
11 MAS Mathis	5/6	83.3%		1/1	1/1	0/1	2/2	1/1			2					2			
12 MEHDI Adam	1/2	50.0%				1/2										1	1		
13 VOIGT Yvano																			
<b>Totals</b>	15/35	42.9%	3/10	2/3	3/6	2/8	2/3	3/5		1	8	14	1	3/4	3	11		2	1
No. Goalkeeper	Saves/Shots																		
	Total	%	A	C	X	6m	PS	CA		Time Outs									
*1 DUTET Corentin	5/8	62.5%	1/2		2/2	2/2	0/2			0 1 0 1									
13 VOIGT Yvano	3/10	30.0%	2/5		1/2	0/2		0/1	Exclusion with Substitution 1										
<b>Totals</b>	8/18	44.4%	3/7		3/4	2/4	0/2	0/1	Exclusion w/Subst after 4 min. 0										
<b>Head Coach</b>	DONSIMONI Alexandre																		
<b>Assistant Coach</b>	GHESQUIERE Jonathan																		



SAT 25 JUN 2022

### Results

Start Time 10:00

## Portugal (POR) 10 - 15 France (FRA)

(2:2 1:4 3:4 4:5)

**Referees:** SPANOUDIS Grigorios (GRE)  
TAYLAN Emanuel Manol (TUR)

Period	POR - Portugal											FRA - France														
	Score	EX	Goals(G)/Misses(M)										CT	Score	EX	Goals(G)/Misses(M)										CT
			X		AA		FT		6mF		PS					X		AA		FT		6mF		PS		
G	M	G	M	G	M	G	M	G	M	G	M	G	M	G	M	G	M	G	M	G	M	G	M			
1st Quarter	2			4	1						1			2												
2nd Quarter	1				3			1			2	1		4		1	1	1	3			1	1	1	1	
3rd Quarter	3	1	1		1	2			1	1				4	1	2	1	1	2				4	1	1	
4th Quarter	4	1		1	3	1				1	1			5				1	4	1			1	1		
<b>Total</b>		2	1	5	5	6		2	2	3	2		1		1	3	3	8	10			2	6	2	1	1

Match POR - FRA												
Score	EX	Goals (G) / Misses (M)										CT
		X		AA		FT		6mF		PS		
G	M	G	M	G	M	G	M	G	M	G	M	CT
10	15	3	4	8	13	16	2	4	9	4	1	2

#### LEGEND

#	Number of possessions	%	Efficiency	20C	20" exclusions in centre	20F	20" exclusions in field
2EX	Double Exclusion	5m	5 Meter Shots	5mF	5 Meter Shots in the field	A	Action Shots
AA	All action shot (A, C, CA)	AS	Assists	BL	Blocked Shots	C	Centre Shots
CA	Counter Attack Shots	CT	Corner throws	EX	Exclusion (S = with substitution N = w	FT	Free throws
G	Goals	M	Misses	No.	Number	P	Penalty Fouls
TF	Turnover Fouls	TWPC	Technical Waterpolo Committee	X	Extra Player Shots	ST	Steals



SAT 25 JUN 2022

Results

Start Time 12:00

Serbia (SRB) 22 - 6 Slovenia (SLO)

(3:2 3:2 7:1 9:1)

Referees: PETRONILLI Arnaldo (ITA)  
JIMENEZ TURNES Sergio (ESP)

SRB - Serbia (White)

No. Name	Goals/Shots									AS	TF	ST	BL	SP	Personal fouls				
	Total	%	A	C	X	6m	PS	CA	20C						20F	2EX	P	EX	
*1 PAJKOVIC Petar																			1
2 MARAS Mitar												1					1	1	
3 DIMITRIJEVIC Marko	1/1	100.0%	1/1										1				1		
4 GAVRILOVIC Bogdan	3/3	100.0%	2/2		1/1						1								
5 KOJIC Nikola	3/6	50.0%	1/2			1/2	0/1	1/1		1		1	1				1		
6 ANDELIC Vuk	1/3	33.3%	0/1			0/1	1/1						1				1		2 S
7 POZANOVIC Zoran	3/3	100.0%	1/1					2/2			1	1					2	1	S
8 UROSEVIC Viktor	2/3	66.7%	1/2				1/1			3			1				1		
9 KOVACEVIC Aleksandar	4/6	66.7%	0/2			1/1	2/2	1/1		1	1	2		4/4					1
10 BRESCANSKI Bogdan	3/3	100.0%	1/1		2/2							1					1		
11 STANIC Petar	2/3	66.7%				2/3				1	1						1		
12 RADULOVIC Nikola Vuk	0/1	0.0%	0/1										1				1	1	
13 VIRIJEVIC Radosav																			
<b>Totals</b>	<b>22/32</b>	<b>68.8%</b>	<b>7/13</b>		<b>3/3</b>	<b>4/7</b>	<b>4/5</b>	<b>4/4</b>		<b>5</b>	<b>4</b>	<b>8</b>	<b>4</b>	<b>4/4</b>		<b>4</b>	<b>9</b>	<b>4</b>	<b>2</b>
No. Goalkeeper	Saves/Shots																		
	Total	%	A	C	X	6m	PS	CA											
*1 PAJKOVIC Petar	6/10	60.0%	2/2		1/1	1/3	2/4			Time Outs 0 0 0 0									
13 VIRIJEVIC Radosav	4/6	66.7%	1/1		1/2	2/3				Exclusion with Substitution 2									
<b>Totals</b>	<b>10/16</b>	<b>62.5%</b>	<b>3/3</b>		<b>2/3</b>	<b>3/6</b>	<b>2/4</b>			Exclusion w/Subst after 4 min. 0									
<b>Head Coach</b>	STEVANOVIC Uros																		
<b>Assistant Coach</b>	BILIC Darko / KOZOMORA Dragan																		

SLO - Slovenia (Blue)

No. Name	Goals/Shots									AS	TF	ST	BL	SP	Personal fouls				
	Total	%	A	C	X	6m	PS	CA	20C						20F	2EX	P	EX	
*1 OSEL Nejc																			
2 CANC Matija Bernard	0/1	0.0%					0/1			1	1								
3 FICUR Gasper														0/1					
4 SELJAK Jurij												1							
5 LAH Jasa	3/6	50.0%	0/1		0/1	2/2	1/2			3	2					1		1	
6 KACIC Tim	0/1	0.0%				0/1								0/1					2
7 RAJLIC Nikola	2/7	28.6%	0/1		1/3	1/3								0/2					
8 PAUNOVIC Aleksander	0/4	0.0%	0/2			0/2						3	1		1				
9 CARNI Jost	0/1	0.0%				0/1													
10 CERAR Aleksander	0/1	0.0%			0/1					1	1				1	2			S
11 GLIGOROVSKI Lukas	1/3	33.3%	0/1		0/1		1/1												2
12 KODER Samo	0/2	0.0%	0/1			0/1													
13 LONCAREVIC Alan																			
<b>Totals</b>	<b>6/26</b>	<b>23.1%</b>	<b>0/6</b>		<b>1/6</b>	<b>3/10</b>	<b>2/4</b>			<b>5</b>	<b>8</b>	<b>1</b>	<b>0/4</b>		<b>2</b>	<b>3</b>	<b>5</b>	<b>1</b>	
No. Goalkeeper	Saves/Shots																		
	Total	%	A	C	X	6m	PS	CA											
*1 OSEL Nejc	3/25	12.0%	2/9		0/3	1/5	0/4	0/4		Time Outs 1 0 0 1									
13 LONCAREVIC Alan	1/1	100.0%				1/1				Exclusion with Substitution 1									
<b>Totals</b>	<b>4/26</b>	<b>15.4%</b>	<b>2/9</b>		<b>0/3</b>	<b>2/6</b>	<b>0/4</b>	<b>0/4</b>		Exclusion w/Subst after 4 min. 0									
<b>Head Coach</b>	SKOF Jure																		
<b>Assistant Coach</b>	HAJDIN Nikola																		



SAT 25 JUN 2022

## Results

Start Time 12:00

### Serbia (SRB) 22 - 6 Slovenia (SLO)

(3:2 3:2 7:1 9:1)

Referees: PETRONILLI Arnaldo (ITA)  
JIMENEZ TURNES Sergio (ESP)

Period	SRB - Serbia											SLO - Slovenia														
	Score	EX	Goals(G)/Misses(M)										CT	Score	EX	Goals(G)/Misses(M)										CT
			X		AA		FT		6mF		PS					X		AA		FT		6mF		PS		
G	M	G	M	G	M	G	M	G	M	G	M	G	M	G	M	G	M	G	M	G	M					
1st Quarter	3		1		1	2				1		1		2						1		1				
2nd Quarter	3		1		1	4				1	2			2					1	2	1	1				
3rd Quarter	7	1			3						4			1	1				1	2						
4th Quarter	9	1	1		6				2	1				1	1					2						
<b>Total</b>		2	3		11	6			4	3	4	1		1	1	5		6	1	1	2	6	2	2		

Match SRB - SLO												
Score	EX	Goals (G) / Misses (M)										CT
		X		AA		FT		6mF		PS		
G	M	G	M	G	M	G	M	G	M	G	M	
22	6	3	4	5	11	12	1	1	6	9	6	3

#### LEGEND

#	Number of possessions	%	Efficiency	20C	20" exclusions in centre	20F	20" exclusions in field
2EX	Double Exclusion	5m	5 Meter Shots	5mF	5 Meter Shots in the field	A	Action Shots
AA	All action shot (A, C, CA)	AS	Assists	BL	Blocked Shots	C	Centre Shots
CA	Counter Attack Shots	CT	Corner throws	EX	Exclusion (S = with substitution N = w	FT	Free throws
G	Goals	M	Misses	No.	Number	P	Penalty Fouls
TF	Turnover Fouls	TWPC	Technical Waterpolo Committee	X	Extra Player Shots	ST	Steals



SUN 26 JUN 2022

### Results

Start Time 10:00

## France (FRA) 7 - 18 Serbia (SRB)

(2:4 1:8 3:2 1:4)

Referees: TAYLAN Emanuel Manol (TUR)  
SPANOUDIS Grigorios (GRE)

#### FRA - France (White)

No. Name	Goals/Shots									AS	TF	ST	BL	SP	Personal fouls					
	Total	%	A	C	X	6m	PS	CA	20C						20F	2EX	P	EX		
1 DUTET Corentin											1									
2 CHAPLET Sandro	0/1	0.0%			0/1															2
3 BLIEK PANNETIER Maxime																				
4 RODRIGUES Clement											2									S
5 LE GOFF Armand	0/2	0.0%				0/1		0/1		1	1									
6 ROUSSEL Evan	1/4	25.0%		0/1	1/1	0/2								0/1						1
7 DE NARDI Pablo	1/4	25.0%	0/1		0/1	1/2														1
8 ONDO METHOGO Leandre														1/1		2	1			S
9 MARCENAT Melvyn											2									1
10 MATHIEU Manatea	3/3	100.0%	1/1			2/2					1			2/2						1
11 MAS Mathis	1/1	100.0%	1/1								5	2	1							2
12 MEHDI Adam	1/6	16.7%	1/2		0/1	0/3						1								1
*13 VOIGT Yvano												1								
<b>Totals</b>	<b>7/21</b>	<b>33.3%</b>	<b>3/5</b>	<b>0/1</b>	<b>1/4</b>	<b>3/10</b>	<b>0/1</b>	<b>0/1</b>	<b>0/1</b>	<b>1</b>	<b>12</b>	<b>4</b>	<b>1</b>	<b>3/4</b>	<b>3</b>	<b>8</b>	<b>3</b>	<b>2</b>	<b>3</b>	<b>2</b>
No. Goalkeeper		Saves/Shots									Time Outs		Exclusion with Substitution		Exclusion w/Subst after 4 min.					
Total	%	A	C	X	6m	PS	CA													
1 DUTET Corentin	3/9	33.3%	3/4	0/1	0/1	0/1	0/1	0/1						0	1	0	1			
*13 VOIGT Yvano	2/14	14.3%	0/4	0/4	0/4	0/1	0/1	0/1	2/4											
<b>Totals</b>	<b>5/23</b>	<b>21.7%</b>	<b>3/8</b>	<b>0/1</b>	<b>0/5</b>	<b>0/2</b>	<b>0/2</b>	<b>2/5</b>												
<b>Head Coach</b>	DONSIMONI Alexandre																			
<b>Assistant Coach</b>	GHESQUIERE Jonathan																			

#### SRB - Serbia (Blue)

No. Name	Goals/Shots									AS	TF	ST	BL	SP	Personal fouls					
	Total	%	A	C	X	6m	PS	CA	20C						20F	2EX	P	EX		
1 PAJKOVIC Petar												1								
2 MARAS Mitar	0/1	0.0%				0/1					1	1								1
3 DIMITRIJEVIC Marko	2/3	66.7%	1/2		1/1					1	1									
4 GAVRILOVIC Bogdan	0/1	0.0%		0/1							1									1
5 KOJIC Nikola	6/7	85.7%	2/2		1/1	1/1	1/1	1/2		1	2	1								
6 ANDELIC Vuk	3/4	75.0%	1/1			0/1		2/2			2			0/1						
7 POZNANOVIC Zoran																				S
8 UROSEVIC Viktor	1/2	50.0%	0/1					1/1			3									
9 KOVACEVIC Aleksandar	2/4	50.0%	1/2		0/1	1/1				1	1	1		0/2						
10 BRESCANSKI Bogdan	2/3	66.7%			2/2			0/1			3									
11 STANIC Petar	2/3	66.7%		1/1	1/1	0/1				1		2								1
12 RADULOVIC Nikola Vuk	0/1	0.0%	0/1											1/1						2
*13 VIRIJEVIC Radosav																				
<b>Totals</b>	<b>18/29</b>	<b>62.1%</b>	<b>5/9</b>	<b>1/2</b>	<b>5/6</b>	<b>2/5</b>	<b>2/2</b>	<b>3/5</b>	<b>3/5</b>	<b>7</b>	<b>11</b>	<b>6</b>	<b>1/4</b>	<b>1</b>	<b>8</b>	<b>1</b>	<b>8</b>	<b>1</b>	<b>1</b>	
No. Goalkeeper		Saves/Shots									Time Outs		Exclusion with Substitution		Exclusion w/Subst after 4 min.					
Total	%	A	C	X	6m	PS	CA													
1 PAJKOVIC Petar	5/9	55.6%	1/2	1/1	1/2	2/4														
*13 VIRIJEVIC Radosav	4/7	57.1%	1/3	1/1	1/1	2/3														
<b>Totals</b>	<b>9/16</b>	<b>56.3%</b>	<b>2/5</b>	<b>1/1</b>	<b>2/3</b>	<b>4/7</b>														
<b>Head Coach</b>	STEVANOVIC Uros																			
<b>Assistant Coach</b>	BILIC Darko / KOZOMORA Dragan																			



SUN 26 JUN 2022

## Results

Start Time 10:00

### France (FRA) 7 - 18 Serbia (SRB)

(2:4 1:8 3:2 1:4)

**Referees:** TAYLAN Emanuel Manol (TUR)  
SPANOUDIS Grigorios (GRE)

Period	FRA - France												SRB - Serbia													
	Score	EX	Goals(G)/Misses(M)										CT	Score	EX	Goals(G)/Misses(M)										CT
			X		AA		FT		6mF		PS					X		AA		FT		6mF		PS		
G	M	G	M	G	M	G	M	G	M	G	M	G	M	G	M	G	M	G	M	G	M	G	M			
1st Quarter	2			1	2	1					3			1		4		3		1	2			1		
2nd Quarter	1	1		1		1				1	1				8		1		5	1			1	1		
3rd Quarter	3	1		1	1					2	1				2	1	1	1	1	3			1	1		
4th Quarter	1		1			2				2					4				2	1		1	1	1		
<b>Total</b>	2	1	3	3	4					3	7			1	1	5	1	9	7		1	2	2	2		

Match FRA - SRB													
Score	EX	Goals (G) / Misses (M)										CT	
		X		AA		FT		6mF		PS			
G	M	G	M	G	M	G	M	G	M	G	M	G	M
7	18	3	6	4	12	11	1	5	9	2		1	

#### LEGEND

#	Number of possessions	%	Efficiency	20C	20" exclusions in centre	20F	20" exclusions in field
2EX	Double Exclusion	5m	5 Meter Shots	5mF	5 Meter Shots in the field	A	Action Shots
AA	All action shot (A, C, CA)	AS	Assists	BL	Blocked Shots	C	Centre Shots
CA	Counter Attack Shots	CT	Corner throws	EX	Exclusion (S = with substitution N = w	FT	Free throws
G	Goals	M	Misses	No.	Number	P	Penalty Fouls
TF	Turnover Fouls	TWPC	Technical Waterpolo Committee	X	Extra Player Shots	ST	Steals



SUN 26 JUN 2022

## Results

Start Time 12:00

### Montenegro (MNE) 23 - 4 Portugal (POR)

(5:1 5:2 6:1 7:0)

Referees: PETRONILLI Arnaldo (ITA)  
JIMENEZ TURNES Sergio (ESP)

#### MNE - Montenegro (White)

No. Name	Goals/Shots									AS	TF	ST	BL	SP	Personal fouls				
	Total	%	A	C	X	6m	PS	CA	20C						20F	2EX	P	EX	
*1 BJELICA Andrija																			
2 VUCKOVIC Balsa	5/6	83.3%	1/2			2/2		2/2					1	0/1			1		
3 DRAGOVIC Danilo																			
4 NIKALJEVIC Milan	1/2	50.0%	0/1					1/1		1						1			1
5 KRIVOKAPIC Pavle	1/2	50.0%	0/1			1/1													
6 VUKSIC Milos	4/5	80.0%	2/3					2/2		3	1	1		1/1		1			
7 VUKICEVIC Vladan	2/2	100.0%			1/1			1/1			1	1							
8 KRIVOKAPIC Danilo	3/6	50.0%	0/1	0/1				1/1	2/3			1							
9 VUKICEVIC Lazar	2/4	50.0%	0/2					1/1	1/1	1			1	1/2					
10 BASTRICA Nedo	2/5	40.0%		1/4	1/1														
11 SAMARDZIC Drasko	2/4	50.0%	0/1			1/2		1/1				1							
12 STUPAR Danilo	1/2	50.0%	0/1					1/1				2				1			
13 VUKOVIC Dusan																			
<b>Totals</b>	<b>23/38</b>	<b>60.5%</b>	<b>3/12</b>	<b>1/5</b>	<b>2/2</b>	<b>4/5</b>	<b>2/2</b>	<b>11/12</b>		<b>4</b>	<b>3</b>	<b>8</b>	<b>1</b>	<b>2/4</b>		<b>1</b>	<b>3</b>		<b>1</b>
No. Goalkeeper	Saves/Shots																		
Total	%	A	C	X	6m	PS	CA												
*1 BJELICA Andrija	3/6	50.0%	1/2		0/1	1/2	1/1												
13 VUKOVIC Dusan	5/6	83.3%	3/3			2/3													
<b>Totals</b>	<b>8/12</b>	<b>66.7%</b>	<b>4/5</b>		<b>0/1</b>	<b>3/5</b>	<b>1/1</b>												
Head Coach	CIROVIC Milan																		
Assistant Coach	MIJANOVIC Nikola / LOMPAR Vido																		

Time Outs	0	0	0	1
Exclusion with Substitution	0			
Exclusion w/Subst after 4 min.	0			

#### POR - Portugal (Blue)

No. Name	Goals/Shots									AS	TF	ST	BL	SP	Personal fouls					
	Total	%	A	C	X	6m	PS	CA	20C						20F	2EX	P	EX		
1 PEREIRA PIRES Joao Pedro																				
2 CARVALHO DIAS Antonio	0/1	0.0%		0/1												1				
3 RODRIGUES Afonso	0/2	0.0%	0/1			0/1							1/1							
5 DE OLIVEIRA FONTANA Marco	0/1	0.0%				0/1							0/1							
6 ROSA INACIO António Guilherme	0/1	0.0%	0/1																	
7 ORNELLAS SANTIAGO Diogo	2/8	25.0%	0/3		1/1	1/3	0/1			1						1				
8 VELOSO SANTOS Rodrigo	0/1	0.0%				0/1						1								
9 GONCALVES FONTELAS Guilherme	0/1	0.0%				0/1										1				
10 FERNANDES MARTINS Rodrigo																				1
11 FRAGOSO PEREIRA Antonio Daniel	0/1	0.0%	0/1							1	1		1/2							
12 GUERREIRO MOREIRA Joao	2/4	50.0%	1/2			1/2						1	1							1
*13 VITAL SIMOES JUHOS Vasco Diniz																				
<b>Totals</b>	<b>4/20</b>	<b>20.0%</b>	<b>1/8</b>	<b>0/1</b>	<b>1/1</b>	<b>2/9</b>	<b>0/1</b>			<b>2</b>	<b>2</b>	<b>2</b>	<b>2/4</b>			<b>3</b>			<b>2</b>	
No. Goalkeeper	Saves/Shots																			
Total	%	A	C	X	6m	PS	CA													
1 PEREIRA PIRES Joao Pedro	2/15	13.3%	1/2	1/2	0/1	0/3	0/1	0/6												
*13 VITAL SIMOES JUHOS Vasco Diniz	4/14	28.6%	2/4	2/2	0/1	0/1	0/1	0/5												
<b>Totals</b>	<b>6/29</b>	<b>20.7%</b>	<b>3/6</b>	<b>3/4</b>	<b>0/2</b>	<b>0/4</b>	<b>0/2</b>	<b>0/11</b>												
Head Coach	ABRUNHOSA Gonçalo																			
Assistant Coach	MATOS MAGALHAES Ana Patricia																			

Time Outs	0	0	1	0
Exclusion with Substitution	0			
Exclusion w/Subst after 4 min.	0			



SUN 26 JUN 2022

### Results

Start Time 12:00

## Montenegro (MNE) 23 - 4 Portugal (POR)

(5:1 5:2 6:1 7:0)

Referees: PETRONILLI Arnaldo (ITA)  
JIMENEZ TURNES Sergio (ESP)

Period	MNE - Montenegro											POR - Portugal														
	Score	EX	Goals(G)/Misses(M)										CT	Score	EX	Goals(G)/Misses(M)										CT
			X		AA		FT		6mF		PS					X		AA		FT		6mF		PS		
G	M	G	M	G	M	G	M	G	M	G	M	G	M	G	M	G	M	G	M	G	M	G	M			
1st Quarter	5				3	5				1		1		2						1		2				
2nd Quarter	5		1		4	6									1			1	1				2	1		
3rd Quarter	6				2	2				3		1						4				1	2			
4th Quarter	7		1		6	1					1							1				2				
<b>Total</b>			2		15	14				4	1	2		2			1		1	8	1		1	7	1	

Match MNE - POR												
Score	EX	Goals (G) / Misses (M)										CT
		X		AA		FT		6mF		PS		
G	M	G	M	G	M	G	M	G	M	G	M	
23	4	3	3	16	22	1		5	8	2	1	2

#### LEGEND

#	Number of possessions	%	Efficiency	20C	20" exclusions in centre	20F	20" exclusions in field
2EX	Double Exclusion	5m	5 Meter Shots	5mF	5 Meter Shots in the field	A	Action Shots
AA	All action shot (A, C, CA)	AS	Assists	BL	Blocked Shots	C	Centre Shots
CA	Counter Attack Shots	CT	Corner throws	EX	Exclusion (S = with substitution N = w	FT	Free throws
G	Goals	M	Misses	No.	Number	P	Penalty Fouls
TF	Turnover Fouls	TWPC	Technical Waterpolo Committee	X	Extra Player Shots	ST	Steals





MON 27 JUN 2022

## Results

Start Time 10:00

### Serbia (SRB) 9 - 8 Montenegro (MNE)

(2:3 1:2 2:1 4:2)

**Referees:** JIMENEZ TURNES Sergio (ESP)  
SPANOUDIS Grigorios (GRE)

#### SRB - Serbia (White)

No. Name	Goals/Shots									AS	TF	ST	BL	SP	Personal fouls					
	Total	%	A	C	X	6m	PS	CA	20C						20F	2EX	P	EX		
*1 PAJKOVIC Petar																				
2 MARAS Mitar																				1
3 DIMITRIJEVIC Marko	0/2	0.0%	0/1			0/1						1	2							
4 GAVRILOVIC Bogdan	0/1	0.0%		0/1						4		1							1	
5 KOJIC Nikola	3/6	50.0%	1/2			1/3		1/1		1	1								1	
6 ANDELIC Vuk	1/2	50.0%			1/1	0/1								0/1						S
7 POZNANOVIC Zoran	0/1	0.0%				0/1					1									
8 UROSEVIC Viktor	1/3	33.3%				0/1	1/1	0/1												
9 KOVACEVIC Aleksandar	2/6	33.3%		0/1		0/3	2/2			2	2	1	3/3					1		1
10 BRESCANSKI Bogdan										1									1	
11 STANIC Petar	1/1	100.0%				1/1						1	1							
12 RADULOVIC Nikola Vuk	1/1	100.0%				1/1													1	
13 VIRIJEVIC Radosav												1								
<b>Totals</b>	<b>9/23</b>	<b>39.1%</b>	<b>1/3</b>	<b>0/2</b>	<b>1/1</b>	<b>3/12</b>	<b>3/3</b>	<b>1/2</b>		<b>8</b>	<b>7</b>	<b>5</b>	<b>3/4</b>		<b>2</b>	<b>4</b>		<b>1</b>	<b>1</b>	
<b>No. Goalkeeper</b>	<b>Saves/Shots</b>																			
	<b>Total</b>	<b>%</b>	<b>A</b>	<b>C</b>	<b>X</b>	<b>6m</b>	<b>PS</b>	<b>CA</b>												
*1 PAJKOVIC Petar	4/9	44.4%	0/1		0/1	4/5	0/1	0/1							Time Outs 0 0 0 1					
13 VIRIJEVIC Radosav	4/7	57.1%	0/1	1/1	1/3	2/2									Exclusion with Substitution 1					
<b>Totals</b>	<b>8/16</b>	<b>50.0%</b>	<b>0/2</b>	<b>1/1</b>	<b>1/4</b>	<b>6/7</b>	<b>0/1</b>	<b>0/1</b>							Exclusion w/Subst after 4 min. 0					
<b>Head Coach</b>	STEVANOVIC Uros																			
<b>Assistant Coach</b>	BILIC Darko / KOZOMORA Dragan																			

#### MNE - Montenegro (Blue)

No. Name	Goals/Shots									AS	TF	ST	BL	SP	Personal fouls					
	Total	%	A	C	X	6m	PS	CA	20C						20F	2EX	P	EX		
*1 BJELICA Andrija												1								
2 VUCKOVIC Balsa	0/3	0.0%		0/1	0/1	0/1						3							1	1
3 DRAGOVIC Danilo																		1		
4 NIKALJEVIC Milan	1/1	100.0%	1/1							1										
5 KRIVOKAPIC Pavle	1/2	50.0%			1/1	0/1						1						1		1
6 VUKSIC Milos	1/4	25.0%			0/1	1/3							0/2		1					
7 VUKICEVIC Vladan	1/4	25.0%				0/3	1/1					1								1
8 KRIVOKAPIC Danilo	0/1	0.0%		0/1																
9 VUKICEVIC Lazar	1/5	20.0%	0/1			0/3		1/1				2	1/2							
10 BASTRICA Nedo	2/5	40.0%		0/1	2/2	0/2				3	1							1		
11 SAMARDZIC Drasko																				
12 STUPAR Danilo	1/3	33.3%	1/1			0/2														
13 VUKOVIC Dusan																				
<b>Totals</b>	<b>8/28</b>	<b>28.6%</b>	<b>2/3</b>	<b>0/3</b>	<b>3/5</b>	<b>1/15</b>	<b>1/1</b>	<b>1/1</b>		<b>1</b>	<b>3</b>	<b>7</b>	<b>2</b>	<b>1/4</b>		<b>2</b>	<b>3</b>		<b>3</b>	
<b>No. Goalkeeper</b>	<b>Saves/Shots</b>																			
	<b>Total</b>	<b>%</b>	<b>A</b>	<b>C</b>	<b>X</b>	<b>6m</b>	<b>PS</b>	<b>CA</b>												
*1 BJELICA Andrija	4/13	30.8%	1/2	1/1	0/1	2/5	0/3	0/1							Time Outs 0 0 1 0					
13 VUKOVIC Dusan															Exclusion with Substitution 0					
<b>Totals</b>	<b>4/13</b>	<b>30.8%</b>	<b>1/2</b>	<b>1/1</b>	<b>0/1</b>	<b>2/5</b>	<b>0/3</b>	<b>0/1</b>							Exclusion w/Subst after 4 min. 0					
<b>Head Coach</b>	CIROVIC Milan																			
<b>Assistant Coach</b>	MIJANOVIC Nikola / LOMPAR Vido																			



MON 27 JUN 2022

## Results

Start Time 10:00

### Serbia (SRB) 9 - 8 Montenegro (MNE)

(2:3 1:2 2:1 4:2)

Referees: JIMENEZ TURNES Sergio (ESP)  
SPANOUDIS Grigorios (GRE)

Period	SRB - Serbia											MNE - Montenegro																
	Score	EX	Goals(G)/Misses(M)										CT	Score	EX	Goals(G)/Misses(M)										CT		
			X		AA		FT		6mF		PS					X		AA		FT		6mF		PS				
G	M	G	M	G	M	G	M	G	M	G	M	G	M	G	M	G	M	G	M	G	M	G	M					
1st Quarter	2		1		1	2					3			1		3		1		1		1	4					
2nd Quarter	1									1	3					2				1	1		2		2	1		
3rd Quarter	2				1					1	2	1				1	1						1			1		
4th Quarter	4	1			1	2	1			1	2					2		1	1	1	3		2		3		1	
<b>Total</b>			1	1		2	5	1		2	9	3				2		3	2	3	4		4	1	10	1		2

Match SRB - MNE													
Score	EX	Goals (G) / Misses (M)										CT	
		X		AA		FT		6mF		PS			
G	M	G	M	G	M	G	M	G	M	G	M	G	M
9	8	1		4	2	5	9	1	4	3	19	4	4

#### LEGEND

#	Number of possessions	%	Efficiency	20C	20" exclusions in centre	20F	20" exclusions in field
2EX	Double Exclusion	5m	5 Meter Shots	5mF	5 Meter Shots in the field	A	Action Shots
AA	All action shot (A, C, CA)	AS	Assists	BL	Blocked Shots	C	Centre Shots
CA	Counter Attack Shots	CT	Corner throws	EX	Exclusion (S = with substitution N = w	FT	Free throws
G	Goals	M	Misses	No.	Number	P	Penalty Fouls
TF	Turnover Fouls	TWPC	Technical Waterpolo Committee	X	Extra Player Shots	ST	Steals



MON 27 JUN 2022

Results

Start Time 12:00

Slovenia (SLO) 11 - 7 France (FRA)

(3:1 1:2 4:1 3:3)

Referees: DURASKOVIC Andrija (MNE)  
PETRONILLI Arnaldo (ITA)

SLO - Slovenia (White)

No.	Name	Goals/Shots								AS	TF	ST	BL	SP	Personal fouls				
		Total	%	A	C	X	6m	PS	CA						20C	20F	2EX	P	EX
*1	OSEL Nejc																		
2	CANC Mattia Bernard	0/1	0.0%	0/1														1	
3	FICUR Gasper										1	1					1		
4	SELJAK Jurij									1									
5	LAH Jasa	2/6	33.3%				1/5	1/1					0/2				1	1	
6	KACIC Tim	2/2	100.0%	1/1		1/1						1	1				1		1
7	RAJLIC Nikola	1/3	33.3%			1/1	0/2						1/2						
8	PAUNOVIC Aleksander	2/5	40.0%	1/1			1/4					1	2				1	2	S
9	CARNI Jost																1		
10	CERAR Aleksander	1/2	50.0%				1/2			1	1	1					2		1 S
11	GLIGOROVSKI Lukas	3/4	75.0%				1/2	2/2									1		
12	KODER Samo																		
13	LONCAREVIC Alan																		
<b>Totals</b>		11/23	47.8%	2/3		2/2	4/15	3/3		2	4	6	1/4				5	7	2 2
No.	Goalkeeper	Saves/Shots								Time Outs									
Total	%	A	C	X	6m	PS	CA	AS	TF	ST	BL	SP	20C	20F	2EX	P	EX		
*1	OSEL Nejc	8/15	53.3%	0/3		3/5	3/4	1/2	1/1									0 1 0 1	
13	LONCAREVIC Alan																	2	
<b>Totals</b>		8/15	53.3%	0/3		3/5	3/4	1/2	1/1									0	
<b>Head Coach</b>		SKOF Jure																	
<b>Assistant Coach</b>		HAJDIN Nikola																	

FRA - France (Blue)

No.	Name	Goals/Shots								AS	TF	ST	BL	SP	Personal fouls				
		Total	%	A	C	X	6m	PS	CA						20C	20F	2EX	P	EX
*1	DUTET Corentin																		
2	CHAPLET Sandro																		
3	BLIEK PANNETIER Maxime	0/1	0.0%					0/1			1								
4	RODRIGUES Clement	1/8	12.5%			0/3	0/3	1/1	0/1	1		1					1		
5	LE GOFF Armand	0/1	0.0%			0/1						1							
6	ROUSSEL Evan	2/4	50.0%	1/1			1/3				1		1				2		
7	DE NARDI Pablo	1/5	20.0%	1/1			0/4					1	1						
8	ONDO METHOGO Leandre	1/4	25.0%			1/2	0/2						1/2					2	
9	MARCENAT Melvyn	1/2	50.0%	1/1			0/1												
10	MATHIEU Manatea	0/2	0.0%			0/1	0/1					1		2/2	1	1			
11	MAS Mathis									1									S
12	MEHDI Adam	1/2	50.0%			1/1	0/1				1								
13	VOIGT Yvano																		
<b>Totals</b>		7/29	24.1%	3/3		2/8	1/15	1/2	0/1	1	4	4	2	3/4	4	1		2	1
No.	Goalkeeper	Saves/Shots								Time Outs									
Total	%	A	C	X	6m	PS	CA	AS	TF	ST	BL	SP	20C	20F	2EX	P	EX		
*1	DUTET Corentin	3/10	30.0%	0/2		0/1	3/5	0/2											1
13	VOIGT Yvano	1/5	20.0%			0/1	1/3	0/1											0
<b>Totals</b>		4/15	26.7%	0/2		0/2	4/8	0/3											0
<b>Head Coach</b>		DONSIMONI Alexandre																	
<b>Assistant Coach</b>		GHESQUIERE Jonathan																	



MON 27 JUN 2022

## Results

Start Time 12:00

### Slovenia (SLO) 11 - 7 France (FRA)

(3:1 1:2 4:1 3:3)

Referees: DURASKOVIC Andrija (MNE)  
PETRONILLI Arnaldo (ITA)

Period	SLO - Slovenia											FRA - France														
	Score	EX	Goals(G)/Misses(M)										CT	Score	EX	Goals(G)/Misses(M)										CT
			X		AA		FT		6mF		PS					X		AA		FT		6mF		PS		
G	M	G	M	G	M	G	M	G	M	G	M	G	M	G	M	G	M	G	M	G	M	G	M			
1st Quarter	3							1	2	3	1		1													
2nd Quarter	1			1	1					2																
3rd Quarter	4		1						2	3	1															
4th Quarter	3	2	1		1					2	1								1	3			1			
<b>Total</b>		2	2		2	1		1	4	10	3		1		1	2	6	3	1		1	1	13	1	1	

Match SLO - FRA													
Score	EX	Goals (G) / Misses (M)										CT	
		X		AA		FT		6mF		PS			
G	M	G	M	G	M	G	M	G	M	G	M	G	M
11	7	3	4	6	5	2	2	5	23	4	1		1

#### LEGEND

#	Number of possessions	%	Efficiency	20C	20" exclusions in centre	20F	20" exclusions in field
2EX	Double Exclusion	5m	5 Meter Shots	5mF	5 Meter Shots in the field	A	Action Shots
AA	All action shot (A, C, CA)	AS	Assists	BL	Blocked Shots	C	Centre Shots
CA	Counter Attack Shots	CT	Corner throws	EX	Exclusion (S = with substitution N = w	FT	Free throws
G	Goals	M	Misses	No.	Number	P	Penalty Fouls
TF	Turnover Fouls	TWPC	Technical Waterpolo Committee	X	Extra Player Shots	ST	Steals



TUE 28 JUN 2022

## Results

Start Time 10:00

### Montenegro (MNE) 11 - 6 Slovenia (SLO)

(3:0 4:4 1:2 3:0)

Referees: PETRONILLI Arnaldo (ITA)  
SPANOUDIS Grigorios (GRE)

#### MNE - Montenegro (White)

No. Name	Goals/Shots									AS	TF	ST	BL	SP	Personal fouls				
	Total	%	A	C	X	6m	PS	CA	20C						20F	2EX	P	EX	
1 BJELICA Andrija																			
2 VUCKOVIC Balsa	3/5	60.0%	1/1			1/3	1/1							1/1					
3 DRAGOVIC Danilo	0/1	0.0%				0/1										1			
4 NIKALJEVIC Milan	1/1	100.0%	1/1							1					1	2			S
5 KRIVOKAPIC Pavle	1/1	100.0%		1/1								1	1					1	
6 VUKSIC Milos												1		0/1		1			
7 VUKICEVIC Vladan	1/3	33.3%	0/2			1/1													
8 KRIVOKAPIC Danilo										2						1			
9 VUKICEVIC Lazar	3/5	60.0%				1/3	1/1	1/1				2		0/2		1			
10 BASTRICA Nedo	2/3	66.7%		1/2	1/1					2									
11 SAMARDZIC Drasko	0/1	0.0%				0/1						1						1	
12 STUPAR Danilo	0/1	0.0%				0/1						1							
*13 VUKOVIC Dusan																			
<b>Totals</b>	11/21	52.4%	2/4	2/3	1/1	3/10	2/2	1/1		5	5	2	1/4		1	6		2	1
No. Goalkeeper	Saves/Shots									Time Outs					0	0	0	2	
1 BJELICA Andrija	3/9	33.3%	1/2	0/2	0/2	1/1	1/2			Exclusion with Substitution					1				
*13 VUKOVIC Dusan	2/2	100.0%	1/1		1/1					Exclusion w/Subst after 4 min.					0				
<b>Totals</b>	5/11	45.5%	2/3	0/2	0/2	2/2	1/2												
<b>Head Coach</b>	CIROVIC Milan																		
<b>Assistant Coach</b>	MIJANOVIC Nikola / LOMPAR Vido																		

#### SLO - Slovenia (Blue)

No. Name	Goals/Shots									AS	TF	ST	BL	SP	Personal fouls				
	Total	%	A	C	X	6m	PS	CA	20C						20F	2EX	P	EX	
*1 OSEL Nejc																			
2 CANC Matija Bernard	2/3	66.7%	0/1	1/1	1/1					1									
3 FICUR Gasper	1/1	100.0%		1/1															
4 SELJAK Jurij	1/1	100.0%			1/1														
5 LAH Jasa	1/2	50.0%				0/1	1/1					1				1		1	
6 KACIC Tim	0/1	0.0%				0/1								1/2					
7 RAJLIC Nikola	0/2	0.0%	0/1			0/1				1				2/2					
8 PAUNOVIC Aleksander																1		1	
9 CARNI Jost	1/1	100.0%	1/1																
10 CERAR Aleksander	0/3	0.0%	0/1		0/1	0/1						1	1		2				
11 GLIGOROVSKI Lukas	0/2	0.0%				0/1	0/1												
12 KODER Samo																			
13 LONCAREVIC Alan																			
<b>Totals</b>	6/16	37.5%	1/4	2/2	2/3	0/5	1/2			2	2	1	3/4		2	2		2	
No. Goalkeeper	Saves/Shots									Time Outs					0	1	0	1	
*1 OSEL Nejc	4/15	26.7%	1/3	1/3	0/1	2/5	0/2	0/1		Exclusion with Substitution					0				
13 LONCAREVIC Alan										Exclusion w/Subst after 4 min.					0				
<b>Totals</b>	4/15	26.7%	1/3	1/3	0/1	2/5	0/2	0/1											
<b>Head Coach</b>	SKOF Jure																		
<b>Assistant Coach</b>	HAJDIN Nikola																		



TUE 28 JUN 2022

### Results

Start Time 10:00

## Montenegro (MNE) 11 - 6 Slovenia (SLO)

(3:0 4:4 1:2 3:0)

Referees: PETRONILLI Arnaldo (ITA)  
SPANOUDIS Grigorios (GRE)

Period	MNE - Montenegro											SLO - Slovenia															
	Score	EX	Goals(G)/Misses(M)										CT	Score	EX	Goals(G)/Misses(M)										CT	
			X		AA		FT		6mF		PS					X		AA		FT		6mF		PS			
G	M	G	M	G	M	G	M	G	M	G	M	G	M	G	M	G	M	G	M	G	M	G	M				
1st Quarter	3				1	1					1	2				0				1				3			
2nd Quarter	4				3	1				1	2					4		1		2			1		1		
3rd Quarter	1		1						1		1					2		1		1				1			
4th Quarter	3	1			1	1				2	2			1		0			1	2					1		
<b>Total</b>		1	1		5	3			1	3	6	2		1				2	1	3	3		1		4	1	1

Match MNE - SLO													
Score	EX	Goals (G) / Misses (M)										CT	
		X		AA		FT		6mF		PS			
G	M	G	M	G	M	G	M	G	M	G	M	G	M
11	6	1		3	1	8	6	2	3	10	3	1	1

#### LEGEND

#	Number of possessions	%	Efficiency	20C	20" exclusions in centre	20F	20" exclusions in field
2EX	Double Exclusion	5m	5 Meter Shots	5mF	5 Meter Shots in the field	A	Action Shots
AA	All action shot (A, C, CA)	AS	Assists	BL	Blocked Shots	C	Centre Shots
CA	Counter Attack Shots	CT	Corner throws	EX	Exclusion (S = with substitution N = w	FT	Free throws
G	Goals	M	Misses	No.	Number	P	Penalty Fouls
TF	Turnover Fouls	TWPC	Technical Waterpolo Committee	X	Extra Player Shots	ST	Steals



TUE 28 JUN 2022

### Results

Start Time 12:00

## Portugal (POR) 3 - 16 Serbia (SRB)

(0:4 1:3 1:4 1:5)

Referees: JIMENEZ TURNES Sergio (ESP)  
TAYLAN Emanuel Manol (TUR)

#### POR - Portugal (White)

No. Name	Goals/Shots									AS	TF	ST	BL	SP	Personal fouls					
	Total	%	A	C	X	6m	PS	CA	20C						20F	2EX	P	EX		
*1 PEREIRA PIRES Joao Pedro																				
2 CARVALHO DIAS Antonio																				
*3 RODRIGUES Afonso	0/2	0.0%	0/1			0/1							0/1	1					1	
4 GONCALVES PINA Diogo Manuel																				
5 DE OLIVEIRA FONTANA Marco													0/2							
6 ROSA INACIO António Guilherme																				
7 ORNELLAS SANTIAGO Diogo	3/11	27.3%	1/2	0/1	1/2	1/6					1	1		1						
8 VELOSO SANTOS Rodrigo																				
9 GONCALVES FONTELAS Guilherme																				
*10 FERNANDES MARTINS Rodrigo																				1
11 FRAGOSO PEREIRA Antonio Daniel													0/1							
12 GUERREIRO MOREIRA Joao	0/4	0.0%				0/4														1
13 VITAL SIMOES JUHOS Vasco Diniz																				
<b>Totals</b>	<b>3/17</b>	<b>17.6%</b>	<b>1/3</b>	<b>0/1</b>	<b>1/2</b>	<b>1/11</b>					<b>1</b>	<b>1</b>	<b>0/4</b>	<b>4</b>					<b>1</b>	
No. Goalkeeper	Saves/Shots																			
	Total	%	A	C	X	6m	PS	CA												
*1 PEREIRA PIRES Joao Pedro	2/13	15.4%	0/5	0/2	0/1	2/2	0/2	0/1												
13 VITAL SIMOES JUHOS Vasco Diniz	0/5	0.0%	0/3		0/1			0/1												
<b>Totals</b>	<b>2/18</b>	<b>11.1%</b>	<b>0/8</b>	<b>0/2</b>	<b>0/2</b>	<b>2/2</b>	<b>0/2</b>	<b>0/2</b>												
<b>Head Coach</b>	ABRUNHOSA Gonçalo																			
<b>Assistant Coach</b>	MATOS MAGALHAES Ana Patrícia																			

Time Outs	0	1	1	0
Exclusion with Substitution				0
Exclusion w/Subst after 4 min.				0

#### SRB - Serbia (Blue)

No. Name	Goals/Shots									AS	TF	ST	BL	SP	Personal fouls					
	Total	%	A	C	X	6m	PS	CA	20C						20F	2EX	P	EX		
1 PAJKOVIC Petar																				
2 MARAS Mitar	1/3	33.3%	1/2	0/1																
3 DIMITRIJEVIC Marko	3/3	100.0%	1/1		1/1		1/1													
4 GAVRILOVIC Bogdan	2/3	66.7%	1/1	0/1				1/1												
5 KOJIC Nikola	2/7	28.6%	2/4			0/3						1/1								
6 ANDELIC Vuk																				
7 POZNANOVIC Zoran													1/1							1
8 UROSEVIC Viktor	2/3	66.7%			1/2		1/1						1/1							
9 KOVACEVIC Aleksandar	3/5	60.0%	1/2	1/1		0/1		1/1		1	2	1	1	1/1						
10 BRESCANSKI Bogdan	2/2	100.0%	1/1	1/1							1									1
11 STANIC Petar	1/4	25.0%	1/1			0/3														
12 RADULOVIC Nikola Vuk																				2
*13 VIRIJEVIC Radosav																				
<b>Totals</b>	<b>16/30</b>	<b>53.3%</b>	<b>8/12</b>	<b>2/4</b>	<b>2/3</b>	<b>0/7</b>	<b>2/2</b>	<b>2/2</b>		<b>1</b>	<b>3</b>	<b>1</b>	<b>1</b>	<b>4/4</b>	<b>2</b>	<b>2</b>				
No. Goalkeeper	Saves/Shots																			
	Total	%	A	C	X	6m	PS	CA												
1 PAJKOVIC Petar	5/6	83.3%		1/1		4/5														
*13 VIRIJEVIC Radosav	5/7	71.4%	2/3		1/2	2/2														
<b>Totals</b>	<b>10/13</b>	<b>76.9%</b>	<b>2/3</b>	<b>1/1</b>	<b>1/2</b>	<b>6/7</b>														
<b>Head Coach</b>	STEVANOVIC Uros																			
<b>Assistant Coach</b>	BILIC Darko / KOZOMORA Dragan																			

Time Outs	0	0	0	0
Exclusion with Substitution				0
Exclusion w/Subst after 4 min.				0



TUE 28 JUN 2022

## Results

Start Time 12:00

### Portugal (POR) 3 - 16 Serbia (SRB)

(0:4 1:3 1:4 1:5)

**Referees:** JIMENEZ TURNES Sergio (ESP)  
TAYLAN Emanuel Manol (TUR)

Period	POR - Portugal											SRB - Serbia																
	Score	EX	Goals(G)/Misses(M)										CT	Score	EX	Goals(G)/Misses(M)										CT		
			X		AA		FT		6mF		PS					X		AA		FT		6mF		PS				
G	M	G	M	G	M	G	M	G	M	G	M	G	M	G	M	G	M	G	M	G	M							
1st Quarter	0										3			4		1	1	3	1									
2nd Quarter	1				1	1					2			3				2	1									
3rd Quarter	1		1			1					1			4				3	2					4	1			
4th Quarter	1					1				1	4			2		1		4	2					2				
<b>Total</b>			1	1	1	3				1	10			2		2	1	12	6					7	2			

Match POR - SRB													
Score	EX	Goals (G) / Misses (M)										CT	
		X		AA		FT		6mF		PS			
G	M	G	M	G	M	G	M	G	M	G	M	G	M
3				3	2	13	9			1	17	2	

#### LEGEND

#	Number of possessions	%	Efficiency	20C	20" exclusions in centre	20F	20" exclusions in field
2EX	Double Exclusion	5m	5 Meter Shots	5mF	5 Meter Shots in the field	A	Action Shots
AA	All action shot (A, C, CA)	AS	Assists	BL	Blocked Shots	C	Centre Shots
CA	Counter Attack Shots	CT	Corner throws	EX	Exclusion (S = with substitution N = w	FT	Free throws
G	Goals	M	Misses	No.	Number	P	Penalty Fouls
TF	Turnover Fouls	TWPC	Technical Waterpolo Committee	X	Extra Player Shots	ST	Steals









WED 29 JUN 2022

**Results**

Start Time 17:00

**Serbia (SRB) 8 - 7 Italy (ITA)**

(3:1 2:0 1:4 2:2)

**Referees:** SPANOUDIS Grigorios (GRE)  
TAYLAN Emanuel Manol (TUR)

**SRB - Serbia (White)**

No. Name	Goals/Shots								AS	TF	ST	BL	SP	Personal fouls					
	Total	%	A	C	X	6m	PS	CA						20C	20F	2EX	P	EX	
1 PAJKOVIC Petar																			
2 MARAS Mitar	1/1	100.0%			1/1													1	
3 DIMITRIJEVIC Marko	2/3	66.7%		1/1	1/2				1									1	
4 GAVRILOVIC Bogdan	2/2	100.0%	1/1	1/1					1		1						1	1	
5 KOJIC Nikola	1/5	20.0%	1/1		0/1	0/3			1		2						1		
6 ANDELIC Vuk	0/3	0.0%	0/1		0/2														
7 POZNANOVIC Zoran	0/1	0.0%				0/1											1		
8 UROSEVIC Viktor	1/3	33.3%			1/2	0/1						2					1		
9 KOVACEVIC Aleksandar	1/2	50.0%	0/1		1/1				1			4/4							
10 BRESCANSKI Bogdan									2		1								
11 STANIC Petar											1						1		
12 RADULOVIC Nikola Vuk	0/1	0.0%			0/1						1						2	1	S
*13 VIRIJEVIC Radosav																			
<b>Totals</b>	<b>8/21</b>	<b>38.1%</b>	<b>2/4</b>	<b>2/2</b>	<b>4/10</b>	<b>0/5</b>			<b>7</b>		<b>8</b>	<b>4/4</b>		<b>6</b>	<b>4</b>		<b>1</b>	<b>1</b>	
No. Goalkeeper	Saves/Shots								Time Outs										
	Total	%	A	C	X	6m	PS	CA											
1 PAJKOVIC Petar																			0 1 0 1
*13 VIRIJEVIC Radosav	9/16	56.3%	2/3		1/1	5/10	0/1	1/1											1
<b>Totals</b>	<b>9/16</b>	<b>56.3%</b>	<b>2/3</b>		<b>1/1</b>	<b>5/10</b>	<b>0/1</b>	<b>1/1</b>											0
<b>Head Coach</b>	STEVANOVIC Uros																		
<b>Assistant Coach</b>	BILIC Darko / KOZOMORA Dragan																		

**ITA - Italy (Blue)**

No. Name	Goals/Shots								AS	TF	ST	BL	SP	Personal fouls					
	Total	%	A	C	X	6m	PS	CA						20C	20F	2EX	P	EX	
*1 VALLE Rocco											3								
2 CORA Tommaso	1/2	50.0%	0/1			1/1					1		0/1				1		
3 BRAGANTINI Matteo	0/5	0.0%	0/1		0/2	0/1		0/1					0/1			1	2		S
4 CAMMAROTA Riccardo									1							1			
5 DE SIMON Riccardo	2/4	50.0%	0/1			1/2	1/1		2		1					1		1	
6 NENNI Angelo																2			
7 NUZZO Andrea	0/6	0.0%	0/1			0/5										2			
8 ROCCHINO Mattia	0/1	0.0%			0/1								0/2			2			
9 GIACOMONE Giorgio	0/2	0.0%	0/1			0/1					1					1			
10 CASANOVA Nicolo'																1			
11 TARAMASCO Nicola	3/7	42.9%	1/2		0/2	2/3													
12 URBINATI Andrea	1/3	33.3%			0/2	1/1										2			
13 VALENZA Jason Danny																			
<b>Totals</b>	<b>7/30</b>	<b>23.3%</b>	<b>1/7</b>		<b>0/7</b>	<b>5/14</b>	<b>1/1</b>	<b>0/1</b>	<b>5</b>		<b>6</b>	<b>1</b>	<b>0/4</b>	<b>8</b>	<b>8</b>		<b>1</b>	<b>1</b>	
No. Goalkeeper	Saves/Shots								Time Outs										
	Total	%	A	C	X	6m	PS	CA											
*1 VALLE Rocco	4/10	40.0%	1/2	0/2	1/4	2/2													0 1 0 1
13 VALENZA Jason Danny	1/3	33.3%	0/1		1/2														1
<b>Totals</b>	<b>5/13</b>	<b>38.5%</b>	<b>1/3</b>	<b>0/2</b>	<b>2/6</b>	<b>2/2</b>													0
<b>Head Coach</b>	ANGELINI Alberto																		
<b>Assistant Coach</b>	BETTINI Daniele																		



WED 29 JUN 2022

## Results

Start Time 17:00

### Serbia (SRB) 8 - 7 Italy (ITA)

(3:1 2:0 1:4 2:2)

**Referees:** SPANOUDIS Grigorios (GRE)  
TAYLAN Emanuel Manol (TUR)

Period	SRB - Serbia											ITA - Italy													
	Score	EX	Goals(G)/Misses(M)								CT	Score	EX	Goals(G)/Misses(M)								CT			
			X		AA		FT		6mF					PS		X		AA		FT			6mF		PS
G	M	G	M	G	M	G	M	G	M	G	M	G	M	G	M	G	M	G	M	G	M	G	M		
1st Quarter	3		1		2	2					1					1		1			1	5			1
2nd Quarter	2		1	3	1						1					3		4				2			2
3rd Quarter	1		1	1							3					2	1	1			2	1	1		1
4th Quarter	2	1	1	2	1											1	1	1			2	1			
<b>Total</b>		1	4	6	4	2					5				1	7	1	7			5	9	1		4

Match SRB - ITA													
Score	EX	Goals (G) / Misses (M)										CT	
		X		AA		FT		6mF		PS			
G	M	G	M	G	M	G	M	G	M	G	M	G	M
8	7	2	4	13	5	9		5	14	1			4

#### LEGEND

#	Number of possessions	%	Efficiency	20C	20" exclusions in centre	20F	20" exclusions in field
2EX	Double Exclusion	5m	5 Meter Shots	5mF	5 Meter Shots in the field	A	Action Shots
AA	All action shot (A, C, CA)	AS	Assists	BL	Blocked Shots	C	Centre Shots
CA	Counter Attack Shots	CT	Corner throws	EX	Exclusion (S = with substitution N = w	FT	Free throws
G	Goals	M	Misses	No.	Number	P	Penalty Fouls
TF	Turnover Fouls	TWPC	Technical Waterpolo Committee	X	Extra Player Shots	ST	Steals



WED 29 JUN 2022

Results

Start Time 10:00

Turkiye (TUR) 10 - 11 France (FRA)

(1:1 1:3 4:3 4:4)

Referees: DURASKOVIC Andrija (MNE)  
HOMOVEC Matjaz (SLO)

TUR - Turkiye (White)

No. Name	Goals/Shots								AS	TF	ST	BL	SP	Personal fouls							
	Total	%	A	C	X	6m	PS	CA						20C	20F	2EX	P	EX			
1 SAHIN Tugrul Alp																					
2 URLU Yaqiz																					
3 ERCIKDI Eren	1/5	20.0%	1/2		0/1	0/2				1										2	
4 CETIN Eren	0/2	0.0%			0/1	0/1					1										
5 KULOGLU Efe	0/1	0.0%				0/1			1		1										
6 KARABENLI Metin	1/4	25.0%	1/1		0/2	0/1						1		1							
7 EROKYAR Ege Mert	1/2	50.0%				1/2				1	1	1	1/4		1	1			1	S	
8 BAKIR Baran																					
9 KOYUNCU Fevzi Emir										1	1	1								1	
10 CANER Guner Ege	5/9	55.6%	1/2		2/2	1/4	1/1													1	
11 SARAC Hayreddin Burak	2/4	50.0%	1/1	1/3						1											
12 INCI Berkan																					
*13 ZOBU Kagan Yucel																					
<b>Totals</b>	10/27	37.0%	4/6	1/3	2/6	2/11	1/1			1	4	4	3	1/4	3	6			2	1	
No. Goalkeeper	Saves/Shots																				
	Total	%	A	C	X	6m	PS	CA													
1 SAHIN Tugrul Alp																					
*13 ZOBU Kagan Yucel	14/25	56.0%	4/7	0/2	2/4	7/8	1/2	0/2													
<b>Totals</b>	14/25	56.0%	4/7	0/2	2/4	7/8	1/2	0/2													
<b>Head Coach</b>	OLCAYTU Mehmet Alp																				
<b>Assistant Coach</b>	BATMAZ Ali / KAHRAMAN Ozgur																				

Time Outs	0	0	1	1
Exclusion with Substitution				1
Exclusion w/Subst after 4 min.				0

FRA - France (Blue)

No. Name	Goals/Shots								AS	TF	ST	BL	SP	Personal fouls						
	Total	%	A	C	X	6m	PS	CA						20C	20F	2EX	P	EX		
1 DUTET Corentin																				
2 CHAPLET Sandro	0/1	0.0%				0/1														1
3 BLIEK PANNETIER Maxime	1/1	100.0%	1/1																	
4 RODRIGUES Clement	0/3	0.0%			0/1	0/1	0/1			2										3
5 LE GOFF Armand	1/3	33.3%	0/1		1/2															1
6 ROUSSEL Evan	2/7	28.6%	0/1		0/2	1/3	1/1			1										1
7 DE NARDI Pablo	1/3	33.3%			1/1	0/2					4									2
8 ONDO METHOGO Leandre	1/4	25.0%	1/4									1	2/2		1	1				
9 MARCENAT Melvyn										1										
10 MATHIEU Manatea	1/4	25.0%		1/1		0/3				1	1		1/2		1					
11 MAS Mathis	3/5	60.0%	0/1	1/1		0/1		2/2		3	2									
12 MEHDI Adam	1/3	33.3%	1/1			0/2				1										
*13 VOIGT Yvano											3									
<b>Totals</b>	11/34	32.4%	3/9	2/2	2/6	1/13	1/2	2/2		1	9	10	1	3/4	2	8			1	1
No. Goalkeeper	Saves/Shots																			
	Total	%	A	C	X	6m	PS	CA												
1 DUTET Corentin																				
*13 VOIGT Yvano	10/20	50.0%	1/5	2/3	4/6	3/5	0/1													
<b>Totals</b>	10/20	50.0%	1/5	2/3	4/6	3/5	0/1													
<b>Head Coach</b>	DONSIMONI Alexandre																			
<b>Assistant Coach</b>	GHESQUIERE Jonathan																			

Time Outs	1	0	0	1
Exclusion with Substitution				1
Exclusion w/Subst after 4 min.				0



WED 29 JUN 2022

Results

Start Time 10:00

Turkiye (TUR) 10 - 11 France (FRA)

(1:1 1:3 4:3 4:4)

Referees: DURASKOVIC Andrija (MNE)  
HOMOVEC Matjaz (SLO)

Period	TUR - Turkiye										FRA - France														
	Score	EX	Goals(G)/Misses(M)								CT	Score	EX	Goals(G)/Misses(M)								CT			
			X		AA		FT		6mF					PS		X		AA		FT			6mF		PS
G	M	G	M	G	M	G	M	G	M	G	M	G	M	G	M	G	M	G	M	G	M	G	M		
1st Quarter	1			1		2				1	1			1		2	1	1			2		1	1	
2nd Quarter	1			1	1					5				3		4					1			1	
3rd Quarter	4		2			1				2	3			3		1	2				1	4		2	
4th Quarter	4	1		2	4	1								4	1	2	1	1	1			5	1	1	
<b>Total</b>		1	2	4	5	4				2	9	1		2	1	2	4	7	6		1	12	1	1	5

Match TUR - FRA												
Score	EX	Goals (G) / Misses (M)								CT		
		X		AA		FT		6mF			PS	
G	M	G	M	G	M	G	M	G	M	G	M	
10	11	2	4	8	12	10		3	21	2	1	7

LEGEND

#	Number of possessions	%	Efficiency	20C	20" exclusions in centre	20F	20" exclusions in field
2EX	Double Exclusion	5m	5 Meter Shots	5mF	5 Meter Shots in the field	A	Action Shots
AA	All action shot (A, C, CA)	AS	Assists	BL	Blocked Shots	C	Centre Shots
CA	Counter Attack Shots	CT	Corner throws	EX	Exclusion (S = with substitution N = w	FT	Free throws
G	Goals	M	Misses	No.	Number	P	Penalty Fouls
TF	Turnover Fouls	TWPC	Technical Waterpolo Committee	X	Extra Player Shots	ST	Steals



WED 29 JUN 2022

Results

Start Time 12:00

Greece (GRE) 16 - 12 Slovenia (SLO)

(5:1 2:4 5:4 4:3)

Referees: JIMENEZ TURNES Sergio (ESP)  
DEHON Ghislain (FRA)

GRE - Greece (White)

No. Name	Goals/Shots									AS	TF	ST	BL	SP	Personal fouls				
	Total	%	A	C	X	6m	PS	CA	20C						20F	2EX	P	EX	
1 DAMIGOS Theodoros														1/1	1				
2 TOURKOMENIS Iason										1									
3 NIKOLAIDIS Georgios	0/2	0.0%	0/1			0/1						2			1	1			
4 TOTTIS Ioannis	2/2	100.0%	2/2									4				2			
5 ALMYRAS Andreas	2/6	33.3%	0/1			1/4	1/1			1	2			0/1	1				
6 KASTRINAKIS Nikolaos	1/3	33.3%	1/1			0/1		0/1							2	1			S
7 BITSAKOS Christos	3/6	50.0%	1/1			1/4	1/1					1		1/1					
8 DEFTERAIOS Fanourios Foivos												1				1			
9 MYRILOS Anastasios	2/3	66.7%	1/1	0/1	1/1					1					1	1			
10 MATHIOPOULOS Konstantinos	3/8	37.5%	0/1			2/3	0/3	1/1						1/1	1	1			
11 SPACHITS Semir	2/2	100.0%		1/1	1/1														
12 KANDANOLEON Konstantinos	1/1	100.0%			1/1					4								2	
*13 ALEIFTIRAS Christos																			
<b>Totals</b>	16/33	48.5%	5/8	1/2	5/6	2/13	3/3	0/1		8	10		3/4		7	7		2	1
No. Goalkeeper	Saves/Shots																		
	Total	%	A	C	X	6m	PS	CA											
1 DAMIGOS Theodoros										Time Outs					0	0	1	1	
*13 ALEIFTIRAS Christos	5/17	29.4%	0/3	0/2	1/4	4/5	0/2	0/1		Exclusion with Substitution								1	
<b>Totals</b>	5/17	29.4%	0/3	0/2	1/4	4/5	0/2	0/1		Exclusion w/Subst after 4 min.								0	
<b>Head Coach</b>	MACHAIRAS Ilias																		
<b>Assistant Coach</b>	ANDREAKOS Teo																		

SLO - Slovenia (Blue)

No. Name	Goals/Shots									AS	TF	ST	BL	SP	Personal fouls				
	Total	%	A	C	X	6m	PS	CA	20C						20F	2EX	P	EX	
*1 OSEL Nejc																			
2 CANC Matija Bernard	3/4	75.0%	0/1	1/1	1/1			1/1		1									
3 FICUR Gasper															1				
4 SELJAK Jurij																			
5 LAH Jasa	5/9	55.6%	1/1		2/3	0/3	2/2								1				
6 KACIC Tim															1				
7 RAJLIC Nikola	0/1	0.0%				0/1								1/4	1				
8 PAUNOVIC Aleksander	0/3	0.0%			0/1	0/2									3				S
9 CARNI Jost												1							
10 CERAR Aleksander	4/4	100.0%	2/2	1/1		1/1						1	1		1			2	S
11 GLIGOROVSKI Lukas	0/2	0.0%				0/2							1						
12 KODER Samo																			
13 LONCAREVIC Alan																			
<b>Totals</b>	12/23	52.2%	3/4	2/2	3/5	1/9	2/2	1/1		1	2	2	1/4		8			2	2
No. Goalkeeper	Saves/Shots																		
	Total	%	A	C	X	6m	PS	CA											
*1 OSEL Nejc	4/11	36.4%	0/4	1/1	0/1	3/4	0/1			Time Outs					0	1	0	1	
13 LONCAREVIC Alan	1/10	10.0%	0/1	0/1	0/4	1/2	0/2			Exclusion with Substitution								2	
<b>Totals</b>	5/21	23.8%	0/5	1/2	0/5	4/6	0/3			Exclusion w/Subst after 4 min.								0	
<b>Head Coach</b>	SKOF Jure																		
<b>Assistant Coach</b>	HAJDIN Nikola																		



WED 29 JUN 2022

### Results

Start Time 12:00

## Greece (GRE) 16 - 12 Slovenia (SLO)

(5:1 2:4 5:4 4:3)

Referees: JIMENEZ TURNES Sergio (ESP)  
DEHON Ghislain (FRA)

Period	GRE - Greece											SLO - Slovenia														
	Score	EX	Goals(G)/Misses(M)										CT	Score	EX	Goals(G)/Misses(M)										CT
			X		AA		FT		6mF		PS					X		AA		FT		6mF		PS		
G	M	G	M	G	M	G	M	G	M	G	M	G	M	G	M	G	M	G	M	G	M					
1st Quarter	5		1		3	2				2	1		1			1	1	1			4					
2nd Quarter	2			1	1	3				1	4		2							1	1	2				
3rd Quarter	5		2		1				1	2	1		4		1		3				1					
4th Quarter	4	1	2		1				3	1		1	3	2	2		1				2		1			
<b>Total</b>		1	5	1	6	5			2	11	3	4		2	3	2	6	1		1	8	2	1			

Match GRE - SLO												
Score	EX	Goals (G) / Misses (M)										CT
		X		AA		FT		6mF		PS		
G	M	G	M	G	M	G	M	G	M	G	M	
16	12	3	8	3	12	6		3	19	5	5	

#### LEGEND

#	Number of possessions	%	Efficiency	20C	20" exclusions in centre	20F	20" exclusions in field
2EX	Double Exclusion	5m	5 Meter Shots	5mF	5 Meter Shots in the field	A	Action Shots
AA	All action shot (A, C, CA)	AS	Assists	BL	Blocked Shots	C	Centre Shots
CA	Counter Attack Shots	CT	Corner throws	EX	Exclusion (S = with substitution N = w	FT	Free throws
G	Goals	M	Misses	No.	Number	P	Penalty Fouls
TF	Turnover Fouls	TWPC	Technical Waterpolo Committee	X	Extra Player Shots	ST	Steals





THU 30 JUN 2022

Results

Start Time 10:00

Spain (ESP) 16 - 8 Italy (ITA)

(2:4 4:1 5:2 5:1)

Referees: DURASKOVIC Andrija (MNE)  
MOREIRA DA SILVA Eurico Simao (PO)

ESP - Spain (White)

No. Name	Goals/Shots									AS	TF	ST	BL	SP	Personal fouls				
	Total	%	A	C	X	6m	PS	CA	20C						20F	2EX	P	EX	
*1 TECLAS GUILLENA Xavier												2							
2 VILLAMAYOR I VILLAR Joan	1/2	50.0%	0/1		1/1														
3 GIL CEDO Gerard	0/1	0.0%	0/1											2/4			1		
4 IVAYLOV PATCHALIEV Daniel	2/4	50.0%	0/1		1/1	1/2				1		1	2						
5 FRIGOLA NAVARRO Marc	2/2	100.0%	1/1		1/1							1							
6 CASTRO FERNANDEZ Hugo	4/4	100.0%			3/3	1/1											2		
7 LOPEZ DUART Robert	2/3	66.7%				0/1	2/2			1	2	3							
8 IBANEZ ALVAREZ Javier																1	2		S
9 PEREZ I RODRIGUEZ Jan	2/4	50.0%			2/4												2		
10 DE LA CRUZ COLAPINTO Luca																1	2		S
11 OTERO VILLALBA Javier	3/3	100.0%	1/1			1/1		1/1								1	1		
12 GOMILA FAIGES Biel																1			
13 GARCIA PLANA Didac																			
<b>Totals</b>	16/24	66.7%	2/5		8/10	3/6	2/2	1/1		2	4	7	2	2/4		4	10		2
No. Goalkeeper	Saves/Shots																		
	Total	%	A	C	X	6m	PS	CA											
*1 TECLAS GUILLENA Xavier	8/16	50.0%	1/3	0/1	4/7	3/3		0/2		Time Outs 0 0 1 0									
13 GARCIA PLANA Didac										Exclusion with Substitution 2									
<b>Totals</b>	8/16	50.0%	1/3	0/1	4/7	3/3		0/2		Exclusion w/Subst after 4 min. 0									
<b>Head Coach</b>	SANCHEZ TORIL Javier																		
<b>Assistant Coach</b>	MARTIN LOZANO Jesus																		

ITA - Italy (Blue)

No. Name	Goals/Shots									AS	TF	ST	BL	SP	Personal fouls				
	Total	%	A	C	X	6m	PS	CA	20C						20F	2EX	P	EX	
*1 VALLE Rocco												4							
2 CORA Tommaso												1				1	1		
3 BRAGANTINI Matteo	2/5	40.0%	1/1		0/2	0/1		1/1		1				0/1		1		1	
4 CAMMAROTA Riccardo																		1	
5 DE SIMON Riccardo	2/3	66.7%		1/1	0/1			1/1		2		1	1/1		1				
6 NENNI Angelo	0/1	0.0%			0/1												1		
7 NUZZO Andrea	1/2	50.0%	1/1		0/1												1		
8 ROCCHINO Mattia	0/1	0.0%	0/1							2			1/2		2				
9 GIACOMONE Giorgio	2/3	66.7%			2/2	0/1						1				2			
10 CASANOVA Nicolo'																			
11 TARASCINO Nicola	1/2	50.0%	0/1		1/1								1		1				
12 URBINATI Andrea	0/2	0.0%			0/1	0/1				1					2				
13 VALENZA Jason Danny																			
<b>Totals</b>	8/19	42.1%	2/4	1/1	3/9	0/3		2/2		8	6	2	2/4		7	6		2	
No. Goalkeeper	Saves/Shots																		
	Total	%	A	C	X	6m	PS	CA											
*1 VALLE Rocco	4/16	25.0%	2/3		1/7	1/4	0/1	0/1		Time Outs 0 0 1 0									
13 VALENZA Jason Danny	0/4	0.0%	0/1		0/2		0/1			Exclusion with Substitution 0									
<b>Totals</b>	4/20	20.0%	2/4		1/9	1/4	0/2	0/1		Exclusion w/Subst after 4 min. 0									
<b>Head Coach</b>	ANGELINI Alberto																		
<b>Assistant Coach</b>	BETTINI Daniele																		



THU 30 JUN 2022

### Results

Start Time 10:00

## Spain (ESP) 16 - 8 Italy (ITA)

(2:4 4:1 5:2 5:1)

Referees: DURASKOVIC Andrija (MNE)  
MOREIRA DA SILVA Eurico Simao (PO)

Period	ESP - Spain											ITA - Italy														
	Score	EX	Goals(G)/Misses(M)										CT	Score	EX	Goals(G)/Misses(M)										CT
			X		AA		FT		6mF		PS					X		AA		FT		6mF		PS		
G	M	G	M	G	M	G	M	G	M	G	M	G	M	G	M	G	M	G	M	G	M					
1st Quarter	2		2	1		1					1		4													
2nd Quarter	4	1	1			1					3		1	2				1								
3rd Quarter	5		2	1	1	1						2	2	1												
4th Quarter	5	1	3		2			1			1		2	1	2											
<b>Total</b>		2	8	2	3	3		1	3	2	2		3	6	5	2		1		2						

Match ESP - ITA												
Score	EX	Goals (G) / Misses (M)										CT
		X		AA		FT		6mF		PS		
G	M	G	M	G	M	G	M	G	M	G	M	
16	8	2	11	8	8	5	2	3	4	2		

#### LEGEND

#	Number of possessions	%	Efficiency	20C	20" exclusions in centre	20F	20" exclusions in field
2EX	Double Exclusion	5m	5 Meter Shots	5mF	5 Meter Shots in the field	A	Action Shots
AA	All action shot (A, C, CA)	AS	Assists	BL	Blocked Shots	C	Centre Shots
CA	Counter Attack Shots	CT	Corner throws	EX	Exclusion (S = with substitution N = w	FT	Free throws
G	Goals	M	Misses	No.	Number	P	Penalty Fouls
TF	Turnover Fouls	TWPC	Technical Waterpolo Committee	X	Extra Player Shots	ST	Steals



THU 30 JUN 2022

Results

Start Time 13:00

Montenegro (MNE) 8 - 9 Serbia (SRB)

(2:1 2:4 3:2 1:2)

Referees: DEHON Ghislain (FRA)  
JIMENEZ TURNES Sergio (ESP)

MNE - Montenegro (White)

No. Name	Goals/Shots									AS	TF	ST	BL	SP	Personal fouls				
	Total	%	A	C	X	6m	PS	CA	20C						20F	2EX	P	EX	
*1 BJELICA Andrija																			
2 VUCKOVIC Balsa	1/2	50.0%			0/1	1/1							2	0/1					
3 DRAGOVIC Danilo																	1		
4 NIKALJEVIC Milan	0/2	0.0%				0/2							1				2		
5 KRIVOKAPIC Pavle										1		1					2		
6 VUKSIC Milos	1/2	50.0%				0/1		1/1				1		0/1			1		
7 VUKICEVIC Vladan	1/2	50.0%	1/1			0/1						1					1		
8 KRIVOKAPIC Danilo	0/1	0.0%				0/1							1				1	1	
9 VUKICEVIC Lazar	3/10	30.0%	0/1	0/1	1/4	1/3	1/1							0/2					
10 BASTRICA Nedo	1/3	33.3%		0/1	1/1			0/1		3	1								
11 SAMARDZIC Drasko	0/2	0.0%				0/2						1							1
12 STUPAR Danilo	1/3	33.3%				1/3						2					2		
13 VUKOVIC Dusan																			
<b>Totals</b>	<b>8/27</b>	<b>29.6%</b>	<b>1/2</b>	<b>0/2</b>	<b>2/6</b>	<b>3/14</b>	<b>1/2</b>	<b>1/1</b>		<b>1</b>	<b>6</b>	<b>7</b>	<b>5</b>	<b>0/4</b>		<b>9</b>	<b>2</b>	<b>1</b>	
No. Goalkeeper	Saves/Shots																		
	Total	%	A	C	X	6m	PS	CA											
*1 BJELICA Andrija	8/17	47.1%	0/2	0/3	3/5	4/5	0/1	1/1											
13 VUKOVIC Dusan																			
<b>Totals</b>	<b>8/17</b>	<b>47.1%</b>	<b>0/2</b>	<b>0/3</b>	<b>3/5</b>	<b>4/5</b>	<b>0/1</b>	<b>1/1</b>											
<b>Head Coach</b>	CIROVIC Milan																		
<b>Assistant Coach</b>	MIJANOVIC Nikola / LOMPAR Vido																		

Time Outs	0	0	0	2
Exclusion with Substitution				0
Exclusion w/Subst after 4 min.				0

SRB - Serbia (Blue)

No. Name	Goals/Shots									AS	TF	ST	BL	SP	Personal fouls				
	Total	%	A	C	X	6m	PS	CA	20C						20F	2EX	P	EX	
1 PAJKOVIC Petar																			
2 MARAS Mitar	1/5	20.0%	0/2		1/2	0/1											1		1
3 DIMITRIJEVIC Marko	1/5	20.0%	0/1		0/1	0/1	1/1	0/1			1					1	1		
4 GAVRILOVIC Bogdan	2/3	66.7%		1/1	1/2					1			1				1		
5 KOJIC Nikola	2/3	66.7%	1/1		0/1	1/1					1					1	1		
6 ANDELIC Vuk	0/2	0.0%				0/2													
7 POZNANOVIC Zoran	0/1	0.0%				0/1				1			1				1		
8 UROSEVIC Viktor	1/3	33.3%	1/2			0/1				1			1			1	2		S
9 KOVACEVIC Aleksandar	1/4	25.0%	0/1	1/1	0/1	0/1						2		4/4		1			
10 BRESCANSKI Bogdan																			
11 STANIC Petar	0/3	0.0%	0/1			0/2										1			
12 RADULOVIC Nikola Vuk	1/1	100.0%		1/1												2			
*13 VIRIJEVIC Radosav												1							1
<b>Totals</b>	<b>9/30</b>	<b>30.0%</b>	<b>2/8</b>	<b>3/3</b>	<b>2/7</b>	<b>1/10</b>	<b>1/1</b>	<b>0/1</b>		<b>3</b>	<b>4</b>	<b>5</b>	<b>3</b>	<b>4/4</b>		<b>5</b>	<b>9</b>	<b>2</b>	<b>1</b>
No. Goalkeeper	Saves/Shots																		
	Total	%	A	C	X	6m	PS	CA											
1 PAJKOVIC Petar																			
*13 VIRIJEVIC Radosav	10/18	55.6%	0/1	1/1	1/3	8/11	0/1	0/1											
<b>Totals</b>	<b>10/18</b>	<b>55.6%</b>	<b>0/1</b>	<b>1/1</b>	<b>1/3</b>	<b>8/11</b>	<b>0/1</b>	<b>0/1</b>											
<b>Head Coach</b>	STEVANOVIC Uros																		
<b>Assistant Coach</b>	BILIC Darko / KOZOMORA Dragan																		

Time Outs	0	0	0	1
Exclusion with Substitution				1
Exclusion w/Subst after 4 min.				0



THU 30 JUN 2022

## Results

Start Time 13:00

### Montenegro (MNE) 8 - 9 Serbia (SRB)

(2:1 2:4 3:2 1:2)

Referees: DEHON Ghislain (FRA)  
JIMENEZ TURNES Sergio (ESP)

Period	MNE - Montenegro											SRB - Serbia														
	Score	EX	Goals(G)/Misses(M)										CT	Score	EX	Goals(G)/Misses(M)										CT
			X		AA		FT		6mF		PS					X		AA		FT		6mF		PS		
G	M	G	M	G	M	G	M	G	M	G	M	G	M	G	M	G	M	G	M	G	M					
1st Quarter	2			2				1				3	1			1										
2nd Quarter	2		1			1	1	1			2							1	1							
3rd Quarter	3				2					1	4			1						3	1					
4th Quarter	1		1	2		2					1						1									
<b>Total</b>			2	4	2	3	2	1	1	10	1	1		2		1	2	5	5	7	2	1	7	1		1

Match MNE - SRB													
Score	EX	Goals (G) / Misses (M)										CT	
		X		AA		FT		6mF		PS			
G	M	G	M	G	M	G	M	G	M	G	M	G	M
8	9	1	4	9	7	10	2	3	2	17	2	1	3

#### LEGEND

#	Number of possessions	%	Efficiency	20C	20" exclusions in centre	20F	20" exclusions in field
2EX	Double Exclusion	5m	5 Meter Shots	5mF	5 Meter Shots in the field	A	Action Shots
AA	All action shot (A, C, CA)	AS	Assists	BL	Blocked Shots	C	Centre Shots
CA	Counter Attack Shots	CT	Corner throws	EX	Exclusion (S = with substitution N = w	FT	Free throws
G	Goals	M	Misses	No.	Number	P	Penalty Fouls
TF	Turnover Fouls	TWPC	Technical Waterpolo Committee	X	Extra Player Shots	ST	Steals



## Overall Team Statistics

As of THU 30 JUN 2022 at 14:17

### Preliminary Round

Team	MP	Goals/Shots								AS	TF	ST	BL	SP	Personal fouls				
		Total	%	A	C	X	6m	PS	CA						20C	20F	2EX	P	EX
ESP-Spain	3	41/79	51,9	13/25	4/8	8/15	9/23	4/5	3/3	12	12	21	3	10/12	7	23		5	2
FRA-France	4	37/106	34,9	12/24	2/6	8/22	6/38	3/6	6/10	5	27	27	5	11/16	15	28		9	5
GRE-Greece	3	38/74	51,4	9/20	4/4	14/24	5/19	2/2	4/5	4	22	28	6	5/12	15	15		3	4
ITA-Italy	3	31/81	38,3	11/31	4/8	9/15	5/24	2/3		4	10	18	10	8/12	20	17		2	4
MNE-Montenegro	4	58/117	49,6	10/29	3/11	13/17	9/36	7/7	16/17	9	17	26	8	6/16	7	17		7	1
POR-Portugal	4	22/92	23,9	7/32	0/5	4/12	7/38	3/4	1/1		10	9	10	5/16	8	12		12	2
SLO-Slovenia	4	41/98	41,8	10/29	4/5	6/12	7/32	9/13	5/7	5	13	18	10	6/16	9	16		10	3
SRB-Serbia	4	65/114	57,0	21/37	3/8	11/13	9/31	11/12	10/13	13	26	22	10	12/16	9	23		5	4
TUR-Turkiye	3	17/64	26,6	2/13	1/1	1/12	6/30	4/5	3/3	1	9	11	11	1/12	10	16		5	2

### Final Rounds

Team	MP	Goals/Shots								AS	TF	ST	BL	SP	Personal fouls				
		Total	%	A	C	X	6m	PS	CA						20C	20F	2EX	P	EX
ESP-Spain	2	25/51	49,0	6/12	0/1	9/13	6/21	3/3	1/1	5	9	12	5	6/8	4	14		3	3
FRA-France	1	11/34	32,4	3/9	2/2	2/6	1/13	1/2	2/2	1	9	10	1	3/4	2	8		1	1
GRE-Greece	1	16/33	48,5	5/8	1/2	5/6	2/13	3/3	0/1		8	10		3/4	7	7		2	1
ITA-Italy	2	15/49	30,6	3/11	1/1	3/16	5/17	1/1	2/3		13	12	3	2/8	15	14		3	1
MNE-Montenegro	2	18/49	36,7	3/7	4/6	2/8	4/22	4/5	1/1	4	11	13	10	0/8	15	3		2	1
SLO-Slovenia	1	12/23	52,2	3/4	2/2	3/5	1/9	2/2	1/1		1	2	2	1/4	8			2	2
SRB-Serbia	2	17/51	33,3	4/12	5/5	6/17	1/15	1/1	0/1	3	11	5	11	8/8	11	13		3	2
TUR-Turkiye	1	10/27	37,0	4/6	1/3	2/6	2/11	1/1		1	4	4	3	1/4	3	6		2	1



## Overall Team Statistics

As of THU 30 JUN 2022 at 14:17

### Overall(Preliminary+Final Rounds)

Team	MP	Goals/Shots								AS	TF	ST	BL	SP	Personal fouls				
		Total	%	A	C	X	6m	PS	CA						20C	20F	2EX	P	EX
ESP-Spain	5	66/130	50,8	19/37	4/9	17/28	15/44	7/8	4/4	17	21	33	8	16/20	11	37		8	5
FRA-France	5	48/140	34,3	15/33	4/8	10/28	7/51	4/8	8/12	6	36	37	6	14/20	17	36		10	6
GRE-Greece	4	54/107	50,5	14/28	5/6	19/30	7/32	5/5	4/6	4	30	38	6	8/16	22	22		5	5
ITA-Italy	5	46/130	35,4	14/42	5/9	12/31	10/41	3/4	2/3	4	23	30	13	10/20	35	31		5	5
MNE-Montenegro	6	76/166	45,8	13/36	7/17	15/25	13/58	11/12	17/18	13	28	39	18	6/24	22	20		9	2
POR-Portugal	4	22/92	23,9	7/32	0/5	4/12	7/38	3/4	1/1		10	9	10	5/16	8	12		12	2
SLO-Slovenia	5	53/121	43,8	13/33	6/7	9/17	8/41	11/15	6/8	5	14	20	12	7/20	17	16		12	5
SRB-Serbia	6	82/165	49,7	25/49	8/13	17/30	10/46	12/13	10/14	16	37	27	21	20/24	20	36		8	6
TUR-Turkiye	4	27/91	29,7	6/19	2/4	3/18	8/41	5/6	3/3	2	13	15	14	2/16	13	22		7	3

#### LEGEND

%	Efficiency	<b>20C</b>	20" exclusions in centre	<b>20F</b>	20" exclusions in field	<b>2EX</b>	Double Exclusion
<b>5m</b>	5 Meter Shots	<b>A</b>	Action Shots	<b>AS</b>	Assists	<b>BL</b>	Blocked Shots
<b>C</b>	Centre Shots	<b>CA</b>	Counter Attack Shots	<b>EX</b>	Exclusion (S = with substitution N = w	<b>MP</b>	Matches Played
<b>TF</b>	Turnover Fouls	<b>X</b>	Extra Player Shots	<b>SP</b>	Sprints (won/sprints)	<b>ST</b>	Steals



## Individual Statistics

As of THU 30 JUN 2022 at 14:18

### Players ranked by goals scored / sprints won

#### Preliminary Round

##### EXTRA PLAYER SHOTS

Rk	No.	Name	Team	MP	Goals	Shots	%
1	10	BASTRICA Nedo	MNE	4	6	7	85.7
2	10	BRESCANSKI Bogdan	SRB	4	4	4	100.0
2	12	KANDANOLEON K.	GRE	3	4	4	100.0
4	6	NENNI Angelo	ITA	3	3	3	100.0
4	7	ORNELLAS SANTIAGO Diogo	POR	4	3	9	33.3
6	3	BRAGANTINI Matteo	ITA	3	2	4	50.0
6	6	CASTRO FERNANDEZ Hugo	ESP	3	2	3	66.7
6	3	DIMITRIJEVIC Marko	SRB	4	2	2	100.0
6	10	MATHIOPOULOS K.	GRE	3	2	2	100.0
6	9	MYRILLOS Anastasios	GRE	3	2	5	40.0
6	7	RAJLIC Nikola	SLO	4	2	4	50.0
6	8	ROCCHINO Mattia	ITA	3	2	3	66.7

##### PENALTY SHOTS

Rk	No.	Name	Team	MP	Goals	Shots	%
1	11	GLIGOROVSKI Lukas	SLO	4	4	5	80.0
1	9	KOVACEVIC Aleksandar	SRB	4	4	4	100.0
1	5	LAH Jasa	SLO	4	4	5	80.0
1	8	UROSEVIC Viktor	SRB	4	4	4	100.0
5	6	CASTRO FERNANDEZ Hugo	ESP	3	2	3	66.7
5	3	ERICIKDI Eren	TUR	3	2	3	66.7
5	8	KRIVOKAPIC Danilo	MNE	4	2	2	100.0
5	11	MAS Mathis	FRA	4	2	2	100.0
5	9	VUKICEVIC Lazar	MNE	4	2	2	100.0
5	7	VUKICEVIC Vladan	MNE	4	2	2	100.0
11	5	ALMYRAS Andreas	GRE	3	1	1	100.0
11	6	ANDELIC Vuk	SRB	4	1	1	100.0

##### ACTION SHOTS

Rk	No.	Name	Team	MP	Goals	Shots	%
1	5	KOJIC Nikola	SRB	4	6	10	60.0
2	5	ALMYRAS Andreas	GRE	3	4	6	66.7
2	5	LAH Jasa	SLO	4	4	5	80.0
4	6	CASTRO FERNANDEZ Hugo	ESP	3	3	7	42.9
4	3	DIMITRIJEVIC Marko	SRB	4	3	5	60.0
4	4	GAVRILOVIC Bogdan	SRB	4	3	3	100.0
4	11	TARAMASCO Nicola	ITA	3	3	5	60.0
4	2	VUCKOVIC Balsa	MNE	4	3	5	60.0
9	7	BITSAKOS Christos	GRE	3	2	4	50.0
9	10	BRESCANSKI Bogdan	SRB	4	2	2	100.0
9	5	FRIGOLA NAVARRO Marc	ESP	3	2	3	66.7
9	12	GUERREIRO MOREIRA Joao	POR	4	2	6	33.3

##### CENTRE SHOTS

Rk	No.	Name	Team	MP	Goals	Shots	%
1	6	NENNI Angelo	ITA	3	4	7	57.1
2	9	PEREZ I RODRIGUEZ Jan	ESP	3	3	3	100.0
3	10	BASTRICA Nedo	MNE	4	2	7	28.6
3	3	FICUR Gasper	SLO	4	2	2	100.0
3	12	KANDANOLEON K.	GRE	3	2	2	100.0
6	10	BRESCANSKI Bogdan	SRB	4	1	1	100.0
6	2	CANC Matija Bernard	SLO	4	1	2	50.0
6	10	DE LA CRUZ L.	ESP	3	1	1	100.0
6	9	KOVACEVIC Aleksandar	SRB	4	1	2	50.0
6	9	KOYUNCU Fevzi Emir	TUR	3	1	1	100.0
6	5	KRIVOKAPIC Pavle	MNE	4	1	1	100.0
6	5	LAH Jasa	SLO	4	1	1	100.0

##### 6m SHOTS

Rk	No.	Name	Team	MP	Goals	Shots	%
1	12	GUERREIRO MOREIRA Joao	POR	4	4	12	33.3
2	10	CANER Guner Ege	TUR	3	3	10	30.0
2	5	KOJIC Nikola	SRB	4	3	9	33.3
2	5	LAH Jasa	SLO	4	3	8	37.5
2	7	LOPEZ DUART Robert	ESP	3	3	8	37.5
2	10	MATHIEU Manatea	FRA	4	3	5	60.0
2	7	ORNELLAS SANTIAGO Diogo	POR	4	3	15	20.0
2	11	STANIC Petar	SRB	4	3	8	37.5
2	2	VUCKOVIC Balsa	MNE	4	3	7	42.9
10	3	BRAGANTINI Matteo	ITA	3	2	4	50.0
10	6	CASTRO FERNANDEZ Hugo	ESP	3	2	2	100.0
10	5	FRIGOLA NAVARRO Marc	ESP	3	2	6	33.3

##### LEADING SPRINTERS

Rk	No.	Name	Team	MP	Goals	Shots	%
1	9	KOVACEVIC Aleksandar	SRB	4	8	10	80.0
2	3	GIL CEDO Gerard	ESP	3	6	7	85.7
2	10	MATHIEU Manatea	FRA	4	6	6	100.0
2	8	ROCCHINO Mattia	ITA	3	6	6	100.0
5	8	ONDO METHOGO Leandre	FRA	4	5	8	62.5
6	2	VILLAMAYOR J.	ESP	3	4	5	80.0
7	7	RAJLIC Nikola	SLO	4	3	6	50.0
8	7	BITSAKOS Christos	GRE	3	2	3	66.7
8	5	DE SIMON Riccardo	ITA	3	2	3	66.7
8	2	VUCKOVIC Balsa	MNE	4	2	3	66.7
8	9	VUKICEVIC Lazar	MNE	4	2	6	33.3
12	5	ALMYRAS Andreas	GRE	3	1	3	33.3

##### COUNTER ATTACK SHOTS

Rk	No.	Name	Team	MP	Goals	Shots	%
1	11	MAS Mathis	FRA	4	4	4	100.0
1	9	VUKICEVIC Lazar	MNE	4	4	4	100.0
3	5	KOJIC Nikola	SRB	4	3	4	75.0
4	6	ANDELIC Vuk	SRB	4	2	2	100.0
4	3	GIL CEDO Gerard	ESP	3	2	2	100.0
4	6	KASTRINAKIS Nikolaos	GRE	3	2	2	100.0
4	9	KOVACEVIC Aleksandar	SRB	4	2	2	100.0
4	8	KRIVOKAPIC Danilo	MNE	4	2	3	66.7
4	4	NIKALJEVIC Milan	MNE	4	2	2	100.0
4	8	PAUNOVIC Aleksander	SLO	4	2	3	66.7
4	7	POZNANOVIC Zoran	SRB	4	2	2	100.0
4	2	VUCKOVIC Balsa	MNE	4	2	2	100.0

##### GOALS AND SHOTS

Rk	No.	Name	Team	MP	Goals	Shots	%
1	5	KOJIC Nikola	SRB	4	14	26	53.8
2	5	LAH Jasa	SLO	4	12	20	60.0
3	9	KOVACEVIC Aleksandar	SRB	4	11	21	52.4
3	2	VUCKOVIC Balsa	MNE	4	11	19	57.9
3	9	VUKICEVIC Lazar	MNE	4	11	21	52.4
6	11	MAS Mathis	FRA	4	10	15	66.7
7	6	CASTRO FERNANDEZ Hugo	ESP	3	9	16	56.3
7	12	GUERREIRO MOREIRA Joao	POR	4	9	21	42.9
9	10	BASTRICA Nedo	MNE	4	8	16	50.0
9	6	NENNI Angelo	ITA	3	8	11	72.7
9	7	ORNELLAS SANTIAGO Diogo	POR	4	8	38	21.1
12	5	ALMYRAS Andreas	GRE	3	7	17	41.2



## Individual Statistics

As of THU 30 JUN 2022 at 14:18

### Players ranked by goals scored / sprints won

#### Final Rounds

##### EXTRA PLAYER SHOTS

Rk	No.	Name	Team	MP	Goals	Shots	%
1	6	CASTRO FERNANDEZ Hugo	ESP	2	3	4	75.0
2	10	CANER Guner Ege	TUR	1	2	2	100.0
2	9	GIACOMONE Giorgio	ITA	2	2	2	100.0
2	5	LAH Jasa	SLO	1	2	3	66.7
2	2	MARAS Mitar	SRB	2	2	3	66.7
2	10	MATHIOPOULOS K.	GRE	1	2	3	66.7
2	9	PEREZ I RODRIGUEZ Jan	ESP	2	2	4	50.0
8	10	BASTRICA Nedo	MNE	2	1	1	100.0
8	2	CANC Matija Bernard	SLO	1	1	1	100.0
8	10	DE LA CRUZ L.	ESP	2	1	1	100.0
8	7	DE NARDI Pablo	FRA	1	1	1	100.0
8	3	DIMITRIJEVIC Marko	SRB	2	1	3	33.3

##### PENALTY SHOTS

Rk	No.	Name	Team	MP	Goals	Shots	%
1	7	LOPEZ DUART Robert	ESP	2	3	3	100.0
2	5	LAH Jasa	SLO	1	2	2	100.0
2	9	VUKICEVIC Lazar	MNE	2	2	2	100.0
4	5	ALMYRAS Andreas	GRE	1	1	1	100.0
4	10	BASTRICA Nedo	MNE	2	1	2	50.0
4	7	BITSAKOS Christos	GRE	1	1	1	100.0
4	10	CANER Guner Ege	TUR	1	1	1	100.0
4	5	DE SIMON Riccardo	ITA	2	1	1	100.0
4	3	DIMITRIJEVIC Marko	SRB	2	1	1	100.0
4	10	MATHIOPOULOS K.	GRE	1	1	1	100.0
4	6	ROUSSEL Evan	FRA	1	1	1	100.0
4	7	VUKICEVIC Vladan	MNE	2	1	1	100.0

##### ACTION SHOTS

Rk	No.	Name	Team	MP	Goals	Shots	%
1	10	CERAR Aleksander	SLO	1	2	2	100.0
1	5	FRIGOLA NAVARRO Marc	ESP	2	2	3	66.7
1	5	KOJIC Nikola	SRB	2	2	2	100.0
1	4	TOTTIS Ioannis	GRE	1	2	2	100.0
1	7	VUKICEVIC Vladan	MNE	2	2	3	66.7
6	7	BITSAKOS Christos	GRE	1	1	1	100.0
6	3	BLIEK PANNETIER Maxime	FRA	1	1	1	100.0
6	3	BRAGANTINI Matteo	ITA	2	1	2	50.0
6	10	CANER Guner Ege	TUR	1	1	2	50.0
6	6	CASTRO FERNANDEZ Hugo	ESP	2	1	2	50.0
6	3	ERCIKI Eren	TUR	1	1	2	50.0
6	4	GAVRILOVIC Bogdan	SRB	2	1	1	100.0

##### CENTRE SHOTS

Rk	No.	Name	Team	MP	Goals	Shots	%
1	10	BASTRICA Nedo	MNE	2	3	4	75.0
2	4	GAVRILOVIC Bogdan	SRB	2	2	2	100.0
3	2	CANC Matija Bernard	SLO	1	1	1	100.0
3	10	CERAR Aleksander	SLO	1	1	1	100.0
3	5	DE SIMON Riccardo	ITA	2	1	1	100.0
3	3	DIMITRIJEVIC Marko	SRB	2	1	1	100.0
3	9	KOVACEVIC Aleksandar	SRB	2	1	1	100.0
3	8	KRIVOKAPIC Danilo	MNE	2	1	1	100.0
3	11	MAS Mathis	FRA	1	1	1	100.0
3	10	MATHIEU Manatea	FRA	1	1	1	100.0
3	12	RADULOVIC Nikola Vuk	SRB	2	1	1	100.0
3	11	SARAC Hayreddin Burak	TUR	1	1	3	33.3

##### 6m SHOTS

Rk	No.	Name	Team	MP	Goals	Shots	%
1	6	CASTRO FERNANDEZ Hugo	ESP	2	2	3	66.7
1	11	TARAMASCO Nicola	ITA	2	2	3	66.7
3	5	ALMYRAS Andreas	GRE	1	1	4	25.0
3	7	BITSAKOS Christos	GRE	1	1	4	25.0
3	10	CANER Guner Ege	TUR	1	1	4	25.0
3	10	CERAR Aleksander	SLO	1	1	1	100.0
3	2	CORA Tommaso	ITA	2	1	1	100.0
3	5	DE SIMON Riccardo	ITA	2	1	2	50.0
3	7	EROKYAR Ege Mert	TUR	1	1	2	50.0
3	5	FRIGOLA NAVARRO Marc	ESP	2	1	5	20.0
3	4	IVAYLOV D.	ESP	2	1	4	25.0
3	5	KOJIC Nikola	SRB	2	1	4	25.0

##### LEADING SPRINTERS

Rk	No.	Name	Team	MP	Goals	Shots	%
1	9	KOVACEVIC Aleksandar	SRB	2	8	8	100.0
2	3	GIL CEDO Gerard	ESP	2	6	8	75.0
3	8	ONDO METHOGO Leandre	FRA	1	2	2	100.0
4	7	BITSAKOS Christos	GRE	1	1	1	100.0
4	5	DE SIMON Riccardo	ITA	2	1	1	100.0
4	7	EROKYAR Ege Mert	TUR	1	1	4	25.0
4	10	MATHIEU Manatea	FRA	1	1	2	50.0
4	10	MATHIOPOULOS K.	GRE	1	1	1	100.0
4	7	RAJLIC Nikola	SLO	1	1	4	25.0
4	8	ROCCHINO Mattia	ITA	2	1	4	25.0
4	2	TOURKOMENIS Iason	GRE	1	1	1	100.0
12	5	ALMYRAS Andreas	GRE	1		1	0.0

##### COUNTER ATTACK SHOTS

Rk	No.	Name	Team	MP	Goals	Shots	%
1	11	MAS Mathis	FRA	1	2	2	100.0
2	3	BRAGANTINI Matteo	ITA	2	1	2	50.0
2	2	CANC Matija Bernard	SLO	1	1	1	100.0
2	5	DE SIMON Riccardo	ITA	2	1	1	100.0
2	11	OTERO VILLALBA Javier	ESP	2	1	1	100.0
2	6	VUKSIC Milos	MNE	2	1	1	100.0
7	3	DIMITRIJEVIC Marko	SRB	2		1	0.0
7	6	KASTRINAKIS Nikolaos	GRE	1		1	0.0

##### GOALS AND SHOTS

Rk	No.	Name	Team	MP	Goals	Shots	%
1	6	CASTRO FERNANDEZ Hugo	ESP	2	6	9	66.7
2	10	BASTRICA Nedo	MNE	2	5	7	71.4
2	10	CANER Guner Ege	TUR	1	5	9	55.6
2	5	LAH Jasa	SLO	1	5	9	55.6
5	10	CERAR Aleksander	SLO	1	4	4	100.0
5	5	DE SIMON Riccardo	ITA	2	4	7	57.1
5	5	FRIGOLA NAVARRO Marc	ESP	2	4	9	44.4
5	4	GAVRILOVIC Bogdan	SRB	2	4	5	80.0
5	7	LOPEZ DUART Robert	ESP	2	4	6	66.7
5	11	TARAMASCO Nicola	ITA	2	4	9	44.4
5	9	VUKICEVIC Lazar	MNE	2	4	15	26.7
12	7	BITSAKOS Christos	GRE	1	3	6	50.0





## Individual Statistics

As of THU 30 JUN 2022 at 14:18

### Players ranked by goals scored / sprints won

#### Overall(Preliminary+Final Rounds)

##### EXTRA PLAYER SHOTS

Rk	No.	Name	Team	MP	Goals	Shots	%
1	10	BASTRICA Nedo	MNE	6	7	8	87.5
2	6	CASTRO FERNANDEZ Hugo	ESP	5	5	7	71.4
2	12	KANDANOLEON K.	GRE	4	5	5	100.0
4	10	BRESCANSKI Bogdan	SRB	6	4	4	100.0
4	10	MATHIOPOULOS K.	GRE	4	4	5	80.0
6	10	CANER Guner Ege	TUR	4	3	7	42.9
6	3	DIMITRIJEVIC Marko	SRB	6	3	5	60.0
6	9	MYRILOS Anastasios	GRE	4	3	6	50.0
6	6	NENNI Angelo	ITA	5	3	4	75.0
6	7	ORNELLAS SANTIAGO Diogo	POR	4	3	9	33.3
6	2	VILLAMAYOR J.	ESP	5	3	3	100.0
6	9	VUKICEVIC Lazar	MNE	6	3	8	37.5

##### PENALTY SHOTS

Rk	No.	Name	Team	MP	Goals	Shots	%
1	5	LAH Jasa	SLO	5	6	7	85.7
2	11	GLIGOROVSKI Lukas	SLO	5	4	5	80.0
2	9	KOVACEVIC Aleksandar	SRB	6	4	4	100.0
2	7	LOPEZ DUART Robert	ESP	5	4	4	100.0
2	8	UROSEVIC Viktor	SRB	6	4	4	100.0
2	9	VUKICEVIC Lazar	MNE	6	4	4	100.0
7	7	VUKICEVIC Vladan	MNE	6	3	3	100.0
8	5	ALMYRAS Andreas	GRE	4	2	2	100.0
8	7	BITSAKOS Christos	GRE	4	2	2	100.0
8	10	CANER Guner Ege	TUR	4	2	2	100.0
8	6	CASTRO FERNANDEZ Hugo	ESP	5	2	3	66.7
8	5	DE SIMON Riccardo	ITA	5	2	2	100.0

##### ACTION SHOTS

Rk	No.	Name	Team	MP	Goals	Shots	%
1	5	KOJIC Nikola	SRB	6	8	12	66.7
2	5	LAH Jasa	SLO	5	5	6	83.3
3	5	ALMYRAS Andreas	GRE	4	4	7	57.1
3	6	CASTRO FERNANDEZ Hugo	ESP	5	4	9	44.4
3	5	FRIGOLA NAVARRO Marc	ESP	5	4	6	66.7
3	4	GAVRILOVIC Bogdan	SRB	6	4	4	100.0
3	11	TARAMASCO Nicola	ITA	5	4	8	50.0
8	7	BITSAKOS Christos	GRE	4	3	5	60.0
8	3	DIMITRIJEVIC Marko	SRB	6	3	6	50.0
8	7	NUZZO Andrea	ITA	5	3	5	60.0
8	4	TOTTIS Ioannis	GRE	4	3	4	75.0
8	2	VUCKOVIC Balsa	MNE	6	3	5	60.0

##### CENTRE SHOTS

Rk	No.	Name	Team	MP	Goals	Shots	%
1	10	BASTRICA Nedo	MNE	6	5	11	45.5
2	6	NENNI Angelo	ITA	5	4	7	57.1
3	9	PEREZ I RODRIGUEZ Jan	ESP	5	3	4	75.0
4	2	CANC Matija Bernard	SLO	5	2	3	66.7
4	3	FICUR Gasper	SLO	5	2	2	100.0
4	4	GAVRILOVIC Bogdan	SRB	6	2	5	40.0
4	12	KANDANOLEON K.	GRE	4	2	2	100.0
4	9	KOVACEVIC Aleksandar	SRB	6	2	3	66.7
4	11	MAS Mathis	FRA	5	2	3	66.7
4	11	SPACHITS Semir	GRE	4	2	2	100.0
11	10	BRESCANSKI Bogdan	SRB	6	1	1	100.0
11	10	CERAR Aleksander	SLO	5	1	1	100.0

##### 6m SHOTS

Rk	No.	Name	Team	MP	Goals	Shots	%
1	10	CANER Guner Ege	TUR	4	4	14	28.6
1	6	CASTRO FERNANDEZ Hugo	ESP	5	4	5	80.0
1	12	GUERREIRO MOREIRA Joao	POR	4	4	12	33.3
1	5	KOJIC Nikola	SRB	6	4	13	30.8
1	7	LOPEZ DUART Robert	ESP	5	4	11	36.4
1	11	TARAMASCO Nicola	ITA	5	4	10	40.0
1	2	VUCKOVIC Balsa	MNE	6	4	8	50.0
8	5	FRIGOLA NAVARRO Marc	ESP	5	3	11	27.3
8	5	LAH Jasa	SLO	5	3	11	27.3
8	10	MATHIEU Manatea	FRA	5	3	8	37.5
8	7	ORNELLAS SANTIAGO Diogo	POR	4	3	15	20.0
8	11	STANIC Petar	SRB	6	3	10	30.0

##### LEADING SPRINTERS

Rk	No.	Name	Team	MP	Goals	Shots	%
1	9	KOVACEVIC Aleksandar	SRB	6	16	18	88.9
2	3	GIL CEDO Gerard	ESP	5	12	15	80.0
3	10	MATHIEU Manatea	FRA	5	7	8	87.5
3	8	ONDO METHOGO Leandre	FRA	5	7	10	70.0
3	8	ROCHINO Mattia	ITA	5	7	10	70.0
6	7	RAJLIC Nikola	SLO	5	4	10	40.0
6	2	VILLAMAYOR J.	ESP	5	4	5	80.0
8	7	BITSAKOS Christos	GRE	4	3	4	75.0
8	5	DE SIMON Riccardo	ITA	5	3	4	75.0
10	10	MATHIOPOULOS K.	GRE	4	2	3	66.7
10	2	VUCKOVIC Balsa	MNE	6	2	4	50.0
10	9	VUKICEVIC Lazar	MNE	6	2	9	22.2

##### COUNTER ATTACK SHOTS

Rk	No.	Name	Team	MP	Goals	Shots	%
1	11	MAS Mathis	FRA	5	6	6	100.0
2	9	VUKICEVIC Lazar	MNE	6	4	4	100.0
3	5	KOJIC Nikola	SRB	6	3	4	75.0
3	6	VUKSIC Milos	MNE	6	3	3	100.0
5	6	ANDELIC Vuk	SRB	6	2	2	100.0
5	3	GIL CEDO Gerard	ESP	5	2	2	100.0
5	6	KASTRINAKIS Nikolaos	GRE	4	2	3	66.7
5	9	KOVACEVIC Aleksandar	SRB	6	2	2	100.0
5	8	KRIVOKAPIC Danilo	MNE	6	2	3	66.7
5	4	NIKALJEVIC Milan	MNE	6	2	2	100.0
5	8	PAUNOVIC Aleksander	SLO	5	2	3	66.7
5	7	POZNANOVIC Zoran	SRB	6	2	2	100.0

##### GOALS AND SHOTS

Rk	No.	Name	Team	MP	Goals	Shots	%
1	5	KOJIC Nikola	SRB	6	17	34	50.0
1	5	LAH Jasa	SLO	5	17	29	58.6
3	6	CASTRO FERNANDEZ Hugo	ESP	5	15	25	60.0
3	9	VUKICEVIC Lazar	MNE	6	15	36	41.7
5	10	BASTRICA Nedo	MNE	6	13	23	56.5
5	9	KOVACEVIC Aleksandar	SRB	6	13	27	48.1
5	11	MAS Mathis	FRA	5	13	20	65.0
8	10	CANER Guner Ege	TUR	4	12	29	41.4
8	2	VUCKOVIC Balsa	MNE	6	12	21	57.1
10	7	LOPEZ DUART Robert	ESP	5	11	22	50.0
11	11	TARAMASCO Nicola	ITA	5	10	23	43.5
11	7	VUKICEVIC Vladan	MNE	6	10	19	52.6

Note: More players tied with the same rank than can fit in the list



## Individual Statistics

As of THU 30 JUN 2022 at 14:18

### Players ranked by goals scored / sprints won

#### Preliminary Round

##### EXTRA PLAYER SHOTS

Rk	No.	Name	Team	MP	Goals	Shots	%
1	10	BASTRICA Nedo	MNE	4	6	7	85.7
2	10	BRESCANSKI Bogdan	SRB	4	4	4	100.0
2	12	KANDANOLEON K.	GRE	3	4	4	100.0
4	6	NENNI Angelo	ITA	3	3	3	100.0
4	7	ORNELLAS SANTIAGO Diogo	POR	4	3	9	33.3
6	3	BRAGANTINI Matteo	ITA	3	2	4	50.0
6	6	CASTRO FERNANDEZ Hugo	ESP	3	2	3	66.7
6	3	DIMITRIJEVIC Marko	SRB	4	2	2	100.0
6	10	MATHIOPOULOS K.	GRE	3	2	2	100.0
6	9	MYRILOS Anastasios	GRE	3	2	5	40.0
6	7	RAJLIC Nikola	SLO	4	2	4	50.0
6	8	ROCCHINO Mattia	ITA	3	2	3	66.7

##### PENALTY SHOTS

Rk	No.	Name	Team	MP	Goals	Shots	%
1	11	GLIGOROVSKI Lukas	SLO	4	4	5	80.0
1	9	KOVACEVIC Aleksandar	SRB	4	4	4	100.0
1	5	LAH Jasa	SLO	4	4	5	80.0
1	8	UROSEVIC Viktor	SRB	4	4	4	100.0
5	6	CASTRO FERNANDEZ Hugo	ESP	3	2	3	66.7
5	3	ERICIKDI Eren	TUR	3	2	3	66.7
5	8	KRIVOKAPIC Danilo	MNE	4	2	2	100.0
5	11	MAS Mathis	FRA	4	2	2	100.0
5	9	VUKICEVIC Lazar	MNE	4	2	2	100.0
5	7	VUKICEVIC Vladan	MNE	4	2	2	100.0
11	5	ALMYRAS Andreas	GRE	3	1	1	100.0
11	6	ANDELIC Vuk	SRB	4	1	1	100.0

##### ACTION SHOTS

Rk	No.	Name	Team	MP	Goals	Shots	%
1	5	KOJIC Nikola	SRB	4	6	10	60.0
2	5	ALMYRAS Andreas	GRE	3	4	6	66.7
2	5	LAH Jasa	SLO	4	4	5	80.0
4	6	CASTRO FERNANDEZ Hugo	ESP	3	3	7	42.9
4	3	DIMITRIJEVIC Marko	SRB	4	3	5	60.0
4	4	GAVRILOVIC Bogdan	SRB	4	3	3	100.0
4	11	TARAMASCO Nicola	ITA	3	3	5	60.0
4	2	VUCKOVIC Balsa	MNE	4	3	5	60.0
9	7	BITSAKOS Christos	GRE	3	2	4	50.0
9	10	BRESCANSKI Bogdan	SRB	4	2	2	100.0
9	5	FRIGOLA NAVARRO Marc	ESP	3	2	3	66.7
9	12	GUERREIRO MOREIRA Joao	POR	4	2	6	33.3

##### CENTRE SHOTS

Rk	No.	Name	Team	MP	Goals	Shots	%
1	6	NENNI Angelo	ITA	3	4	7	57.1
2	9	PEREZ I RODRIGUEZ Jan	ESP	3	3	3	100.0
3	10	BASTRICA Nedo	MNE	4	2	7	28.6
3	3	FICUR Gasper	SLO	4	2	2	100.0
3	12	KANDANOLEON K.	GRE	3	2	2	100.0
6	10	BRESCANSKI Bogdan	SRB	4	1	1	100.0
6	2	CANC Matija Bernard	SLO	4	1	2	50.0
6	10	DE LA CRUZ L.	ESP	3	1	1	100.0
6	9	KOVACEVIC Aleksandar	SRB	4	1	2	50.0
6	9	KOYUNCU Fevzi Emir	TUR	3	1	1	100.0
6	5	KRIVOKAPIC Pavle	MNE	4	1	1	100.0
6	5	LAH Jasa	SLO	4	1	1	100.0

##### 6m SHOTS

Rk	No.	Name	Team	MP	Goals	Shots	%
1	12	GUERREIRO MOREIRA Joao	POR	4	4	12	33.3
2	10	CANER Guner Ege	TUR	3	3	10	30.0
2	5	KOJIC Nikola	SRB	4	3	9	33.3
2	5	LAH Jasa	SLO	4	3	8	37.5
2	7	LOPEZ DUART Robert	ESP	3	3	8	37.5
2	10	MATHIEU Manatea	FRA	4	3	5	60.0
2	7	ORNELLAS SANTIAGO Diogo	POR	4	3	15	20.0
2	11	STANIC Petar	SRB	4	3	8	37.5
2	2	VUCKOVIC Balsa	MNE	4	3	7	42.9
10	3	BRAGANTINI Matteo	ITA	3	2	4	50.0
10	6	CASTRO FERNANDEZ Hugo	ESP	3	2	2	100.0
10	5	FRIGOLA NAVARRO Marc	ESP	3	2	6	33.3

##### LEADING SPRINTERS

Rk	No.	Name	Team	MP	Goals	Shots	%
1	9	KOVACEVIC Aleksandar	SRB	4	8	10	80.0
2	3	GIL CEDO Gerard	ESP	3	6	7	85.7
2	10	MATHIEU Manatea	FRA	4	6	6	100.0
2	8	ROCCHINO Mattia	ITA	3	6	6	100.0
5	8	ONDO METHOGO Leandre	FRA	4	5	8	62.5
6	2	VILLAMAYOR J.	ESP	3	4	5	80.0
7	7	RAJLIC Nikola	SLO	4	3	6	50.0
8	7	BITSAKOS Christos	GRE	3	2	3	66.7
8	5	DE SIMON Riccardo	ITA	3	2	3	66.7
8	2	VUCKOVIC Balsa	MNE	4	2	3	66.7
8	9	VUKICEVIC Lazar	MNE	4	2	6	33.3
12	5	ALMYRAS Andreas	GRE	3	1	3	33.3

##### COUNTER ATTACK SHOTS

Rk	No.	Name	Team	MP	Goals	Shots	%
1	11	MAS Mathis	FRA	4	4	4	100.0
1	9	VUKICEVIC Lazar	MNE	4	4	4	100.0
3	5	KOJIC Nikola	SRB	4	3	4	75.0
4	6	ANDELIC Vuk	SRB	4	2	2	100.0
4	3	GIL CEDO Gerard	ESP	3	2	2	100.0
4	6	KASTRINAKIS Nikolaos	GRE	3	2	2	100.0
4	9	KOVACEVIC Aleksandar	SRB	4	2	2	100.0
4	8	KRIVOKAPIC Danilo	MNE	4	2	3	66.7
4	4	NIKALJEVIC Milan	MNE	4	2	2	100.0
4	8	PAUNOVIC Aleksander	SLO	4	2	3	66.7
4	7	POZNANOVIC Zoran	SRB	4	2	2	100.0
4	2	VUCKOVIC Balsa	MNE	4	2	2	100.0

##### GOALS AND SHOTS

Rk	No.	Name	Team	MP	Goals	Shots	%
1	5	KOJIC Nikola	SRB	4	14	26	53.8
2	5	LAH Jasa	SLO	4	12	20	60.0
3	9	KOVACEVIC Aleksandar	SRB	4	11	21	52.4
3	2	VUCKOVIC Balsa	MNE	4	11	19	57.9
3	9	VUKICEVIC Lazar	MNE	4	11	21	52.4
6	11	MAS Mathis	FRA	4	10	15	66.7
7	6	CASTRO FERNANDEZ Hugo	ESP	3	9	16	56.3
7	12	GUERREIRO MOREIRA Joao	POR	4	9	21	42.9
9	10	BASTRICA Nedo	MNE	4	8	16	50.0
9	6	NENNI Angelo	ITA	3	8	11	72.7
9	7	ORNELLAS SANTIAGO Diogo	POR	4	8	38	21.1
12	5	ALMYRAS Andreas	GRE	3	7	17	41.2



## Individual Statistics

As of THU 30 JUN 2022 at 14:18

### Players ranked by goals scored / sprints won

#### Final Rounds

##### EXTRA PLAYER SHOTS

Rk	No.	Name	Team	MP	Goals	Shots	%
1	6	CASTRO FERNANDEZ Hugo	ESP	2	3	4	75.0
2	10	CANER Guner Ege	TUR	1	2	2	100.0
2	9	GIACOMONE Giorgio	ITA	2	2	2	100.0
2	5	LAH Jasa	SLO	1	2	3	66.7
2	2	MARAS Mitar	SRB	2	2	3	66.7
2	10	MATHIOPOULOS K.	GRE	1	2	3	66.7
2	9	PEREZ I RODRIGUEZ Jan	ESP	2	2	4	50.0
8	10	BASTRICA Nedo	MNE	2	1	1	100.0
8	2	CANC Matija Bernard	SLO	1	1	1	100.0
8	10	DE LA CRUZ L.	ESP	2	1	1	100.0
8	7	DE NARDI Pablo	FRA	1	1	1	100.0
8	3	DIMITRIJEVIC Marko	SRB	2	1	3	33.3

##### PENALTY SHOTS

Rk	No.	Name	Team	MP	Goals	Shots	%
1	7	LOPEZ DUART Robert	ESP	2	3	3	100.0
2	5	LAH Jasa	SLO	1	2	2	100.0
2	9	VUKICEVIC Lazar	MNE	2	2	2	100.0
4	5	ALMYRAS Andreas	GRE	1	1	1	100.0
4	10	BASTRICA Nedo	MNE	2	1	2	50.0
4	7	BITSAKOS Christos	GRE	1	1	1	100.0
4	10	CANER Guner Ege	TUR	1	1	1	100.0
4	5	DE SIMON Riccardo	ITA	2	1	1	100.0
4	3	DIMITRIJEVIC Marko	SRB	2	1	1	100.0
4	10	MATHIOPOULOS K.	GRE	1	1	1	100.0
4	6	ROUSSEL Evan	FRA	1	1	1	100.0
4	7	VUKICEVIC Vladan	MNE	2	1	1	100.0

##### ACTION SHOTS

Rk	No.	Name	Team	MP	Goals	Shots	%
1	10	CERAR Aleksander	SLO	1	2	2	100.0
1	5	FRIGOLA NAVARRO Marc	ESP	2	2	3	66.7
1	5	KOJIC Nikola	SRB	2	2	2	100.0
1	4	TOTTIS Ioannis	GRE	1	2	2	100.0
1	7	VUKICEVIC Vladan	MNE	2	2	3	66.7
6	7	BITSAKOS Christos	GRE	1	1	1	100.0
6	3	BLIEK PANNETIER Maxime	FRA	1	1	1	100.0
6	3	BRAGANTINI Matteo	ITA	2	1	2	50.0
6	10	CANER Guner Ege	TUR	1	1	2	50.0
6	6	CASTRO FERNANDEZ Hugo	ESP	2	1	2	50.0
6	3	ERICIKI Eren	TUR	1	1	2	50.0
6	4	GAVRILOVIC Bogdan	SRB	2	1	1	100.0

##### CENTRE SHOTS

Rk	No.	Name	Team	MP	Goals	Shots	%
1	10	BASTRICA Nedo	MNE	2	3	4	75.0
2	4	GAVRILOVIC Bogdan	SRB	2	2	2	100.0
3	2	CANC Matija Bernard	SLO	1	1	1	100.0
3	10	CERAR Aleksander	SLO	1	1	1	100.0
3	5	DE SIMON Riccardo	ITA	2	1	1	100.0
3	3	DIMITRIJEVIC Marko	SRB	2	1	1	100.0
3	9	KOVACEVIC Aleksandar	SRB	2	1	1	100.0
3	8	KRIVOKAPIC Danilo	MNE	2	1	1	100.0
3	11	MAS Mathis	FRA	1	1	1	100.0
3	10	MATHIEU Manatea	FRA	1	1	1	100.0
3	12	RADULOVIC Nikola Vuk	SRB	2	1	1	100.0
3	11	SARAC Hayreddin Burak	TUR	1	1	3	33.3

##### 6m SHOTS

Rk	No.	Name	Team	MP	Goals	Shots	%
1	6	CASTRO FERNANDEZ Hugo	ESP	2	2	3	66.7
1	11	TARAMASCO Nicola	ITA	2	2	3	66.7
3	5	ALMYRAS Andreas	GRE	1	1	4	25.0
3	7	BITSAKOS Christos	GRE	1	1	4	25.0
3	10	CANER Guner Ege	TUR	1	1	4	25.0
3	10	CERAR Aleksander	SLO	1	1	1	100.0
3	2	CORA Tommaso	ITA	2	1	1	100.0
3	5	DE SIMON Riccardo	ITA	2	1	2	50.0
3	7	EROKYAR Ege Mert	TUR	1	1	2	50.0
3	5	FRIGOLA NAVARRO Marc	ESP	2	1	5	20.0
3	4	IVAYLOV D.	ESP	2	1	4	25.0
3	5	KOJIC Nikola	SRB	2	1	4	25.0

##### LEADING SPRINTERS

Rk	No.	Name	Team	MP	Goals	Shots	%
1	9	KOVACEVIC Aleksandar	SRB	2	8	8	100.0
2	3	GIL CEDO Gerard	ESP	2	6	8	75.0
3	8	ONDO METHOGO Leandre	FRA	1	2	2	100.0
4	7	BITSAKOS Christos	GRE	1	1	1	100.0
4	5	DE SIMON Riccardo	ITA	2	1	1	100.0
4	7	EROKYAR Ege Mert	TUR	1	1	4	25.0
4	10	MATHIEU Manatea	FRA	1	1	2	50.0
4	10	MATHIOPOULOS K.	GRE	1	1	1	100.0
4	7	RAJLIC Nikola	SLO	1	1	4	25.0
4	8	ROCCHINO Mattia	ITA	2	1	4	25.0
4	2	TOURKOMENIS Iason	GRE	1	1	1	100.0
12	5	ALMYRAS Andreas	GRE	1		1	0.0

##### COUNTER ATTACK SHOTS

Rk	No.	Name	Team	MP	Goals	Shots	%
1	11	MAS Mathis	FRA	1	2	2	100.0
2	3	BRAGANTINI Matteo	ITA	2	1	2	50.0
2	2	CANC Matija Bernard	SLO	1	1	1	100.0
2	5	DE SIMON Riccardo	ITA	2	1	1	100.0
2	11	OTERO VILLALBA Javier	ESP	2	1	1	100.0
2	6	VUKSIC Milos	MNE	2	1	1	100.0
7	3	DIMITRIJEVIC Marko	SRB	2		1	0.0
7	6	KASTRINAKIS Nikolaos	GRE	1		1	0.0

##### GOALS AND SHOTS

Rk	No.	Name	Team	MP	Goals	Shots	%
1	6	CASTRO FERNANDEZ Hugo	ESP	2	6	9	66.7
2	10	BASTRICA Nedo	MNE	2	5	7	71.4
2	10	CANER Guner Ege	TUR	1	5	9	55.6
2	5	LAH Jasa	SLO	1	5	9	55.6
5	10	CERAR Aleksander	SLO	1	4	4	100.0
5	5	DE SIMON Riccardo	ITA	2	4	7	57.1
5	5	FRIGOLA NAVARRO Marc	ESP	2	4	9	44.4
5	4	GAVRILOVIC Bogdan	SRB	2	4	5	80.0
5	7	LOPEZ DUART Robert	ESP	2	4	6	66.7
5	11	TARAMASCO Nicola	ITA	2	4	9	44.4
5	9	VUKICEVIC Lazar	MNE	2	4	15	26.7
12	7	BITSAKOS Christos	GRE	1	3	6	50.0



## Individual Statistics

As of THU 30 JUN 2022 at 14:18

### Players ranked by goals scored / sprints won

#### Overall(Preliminary+Final Rounds)

##### EXTRA PLAYER SHOTS

Rk	No.	Name	Team	MP	Goals	Shots	%
1	10	BASTRICA Nedo	MNE	6	7	8	87.5
2	6	CASTRO FERNANDEZ Hugo	ESP	5	5	7	71.4
2	12	KANDANOLEON K.	GRE	4	5	5	100.0
4	10	BRESCANSKI Bogdan	SRB	6	4	4	100.0
4	10	MATHIOPOULOS K.	GRE	4	4	5	80.0
6	10	CANER Guner Ege	TUR	4	3	7	42.9
6	3	DIMITRIJEVIC Marko	SRB	6	3	5	60.0
6	9	MYRILOS Anastasios	GRE	4	3	6	50.0
6	6	NENNI Angelo	ITA	5	3	4	75.0
6	7	ORNELLAS SANTIAGO Diogo	POR	4	3	9	33.3
6	2	VILLAMAYOR J.	ESP	5	3	3	100.0
6	9	VUKICEVIC Lazar	MNE	6	3	8	37.5

##### PENALTY SHOTS

Rk	No.	Name	Team	MP	Goals	Shots	%
1	5	LAH Jasa	SLO	5	6	7	85.7
2	11	GLIGOROVSKI Lukas	SLO	5	4	5	80.0
2	9	KOVACEVIC Aleksandar	SRB	6	4	4	100.0
2	7	LOPEZ DUART Robert	ESP	5	4	4	100.0
2	8	UROSEVIC Viktor	SRB	6	4	4	100.0
2	9	VUKICEVIC Lazar	MNE	6	4	4	100.0
7	7	VUKICEVIC Vladan	MNE	6	3	3	100.0
8	5	ALMYRAS Andreas	GRE	4	2	2	100.0
8	7	BITSAKOS Christos	GRE	4	2	2	100.0
8	10	CANER Guner Ege	TUR	4	2	2	100.0
8	6	CASTRO FERNANDEZ Hugo	ESP	5	2	3	66.7
8	5	DE SIMON Riccardo	ITA	5	2	2	100.0

##### ACTION SHOTS

Rk	No.	Name	Team	MP	Goals	Shots	%
1	5	KOJIC Nikola	SRB	6	8	12	66.7
2	5	LAH Jasa	SLO	5	5	6	83.3
3	5	ALMYRAS Andreas	GRE	4	4	7	57.1
3	6	CASTRO FERNANDEZ Hugo	ESP	5	4	9	44.4
3	5	FRIGOLA NAVARRO Marc	ESP	5	4	6	66.7
3	4	GAVRILOVIC Bogdan	SRB	6	4	4	100.0
3	11	TARAMASCO Nicola	ITA	5	4	8	50.0
8	7	BITSAKOS Christos	GRE	4	3	5	60.0
8	3	DIMITRIJEVIC Marko	SRB	6	3	6	50.0
8	7	NUZZO Andrea	ITA	5	3	5	60.0
8	4	TOTTIS Ioannis	GRE	4	3	4	75.0
8	2	VUCKOVIC Balsa	MNE	6	3	5	60.0

##### CENTRE SHOTS

Rk	No.	Name	Team	MP	Goals	Shots	%
1	10	BASTRICA Nedo	MNE	6	5	11	45.5
2	6	NENNI Angelo	ITA	5	4	7	57.1
3	9	PEREZ I RODRIGUEZ Jan	ESP	5	3	4	75.0
4	2	CANC Matija Bernard	SLO	5	2	3	66.7
4	3	FICUR Gasper	SLO	5	2	2	100.0
4	4	GAVRILOVIC Bogdan	SRB	6	2	5	40.0
4	12	KANDANOLEON K.	GRE	4	2	2	100.0
4	9	KOVACEVIC Aleksandar	SRB	6	2	3	66.7
4	11	MAS Mathis	FRA	5	2	3	66.7
4	11	SPACHITS Semir	GRE	4	2	2	100.0
11	10	BRESCANSKI Bogdan	SRB	6	1	1	100.0
11	10	CERAR Aleksander	SLO	5	1	1	100.0

##### 6m SHOTS

Rk	No.	Name	Team	MP	Goals	Shots	%
1	10	CANER Guner Ege	TUR	4	4	14	28.6
1	6	CASTRO FERNANDEZ Hugo	ESP	5	4	5	80.0
1	12	GUERREIRO MOREIRA Joao	POR	4	4	12	33.3
1	5	KOJIC Nikola	SRB	6	4	13	30.8
1	7	LOPEZ DUART Robert	ESP	5	4	11	36.4
1	11	TARAMASCO Nicola	ITA	5	4	10	40.0
1	2	VUCKOVIC Balsa	MNE	6	4	8	50.0
8	5	FRIGOLA NAVARRO Marc	ESP	5	3	11	27.3
8	5	LAH Jasa	SLO	5	3	11	27.3
8	10	MATHIEU Manatea	FRA	5	3	8	37.5
8	7	ORNELLAS SANTIAGO Diogo	POR	4	3	15	20.0
8	11	STANIC Petar	SRB	6	3	10	30.0

##### LEADING SPRIERS

Rk	No.	Name	Team	MP	Goals	Shots	%
1	9	KOVACEVIC Aleksandar	SRB	6	16	18	88.9
2	3	GIL CEDO Gerard	ESP	5	12	15	80.0
3	10	MATHIEU Manatea	FRA	5	7	8	87.5
3	8	ONDO METHOGO Leandre	FRA	5	7	10	70.0
3	8	ROCHINO Mattia	ITA	5	7	10	70.0
6	7	RAJLIC Nikola	SLO	5	4	10	40.0
6	2	VILLAMAYOR J.	ESP	5	4	5	80.0
8	7	BITSAKOS Christos	GRE	4	3	4	75.0
8	5	DE SIMON Riccardo	ITA	5	3	4	75.0
10	10	MATHIOPOULOS K.	GRE	4	2	3	66.7
10	2	VUCKOVIC Balsa	MNE	6	2	4	50.0
10	9	VUKICEVIC Lazar	MNE	6	2	9	22.2

##### COUNTER ATTACK SHOTS

Rk	No.	Name	Team	MP	Goals	Shots	%
1	11	MAS Mathis	FRA	5	6	6	100.0
2	9	VUKICEVIC Lazar	MNE	6	4	4	100.0
3	5	KOJIC Nikola	SRB	6	3	4	75.0
3	6	VUKSIC Milos	MNE	6	3	3	100.0
5	6	ANDELIC Vuk	SRB	6	2	2	100.0
5	3	GIL CEDO Gerard	ESP	5	2	2	100.0
5	6	KASTRINAKIS Nikolaos	GRE	4	2	3	66.7
5	9	KOVACEVIC Aleksandar	SRB	6	2	2	100.0
5	8	KRIVOKAPIC Danilo	MNE	6	2	3	66.7
5	4	NIKALJEVIC Milan	MNE	6	2	2	100.0
5	8	PAUNOVIC Aleksander	SLO	5	2	3	66.7
5	7	POZNANOVIC Zoran	SRB	6	2	2	100.0

##### GOALS AND SHOTS

Rk	No.	Name	Team	MP	Goals	Shots	%
1	5	KOJIC Nikola	SRB	6	17	34	50.0
1	5	LAH Jasa	SLO	5	17	29	58.6
3	6	CASTRO FERNANDEZ Hugo	ESP	5	15	25	60.0
3	9	VUKICEVIC Lazar	MNE	6	15	36	41.7
5	10	BASTRICA Nedo	MNE	6	13	23	56.5
5	9	KOVACEVIC Aleksandar	SRB	6	13	27	48.1
5	11	MAS Mathis	FRA	5	13	20	65.0
8	10	CANER Guner Ege	TUR	4	12	29	41.4
8	2	VUCKOVIC Balsa	MNE	6	12	21	57.1
10	7	LOPEZ DUART Robert	ESP	5	11	22	50.0
11	11	TARAMASCO Nicola	ITA	5	10	23	43.5
11	7	VUKICEVIC Vladan	MNE	6	10	19	52.6

Note: More players tied with the same rank than can fit in the list



## Individual Statistics - Leading Scorers

As of THU 30 JUN 2022 at 14:19

Rank	No.	Name	Team	Match Played	Preliminary	Final	Overall	
					Round	Rounds	Goals/Shots	%
1	5	KOJIC Nikola (SRB)	SRB	6	14/26	3/8	17/34	50.0%
1	5	LAH Jasa (SLO)	SLO	5	12/20	5/9	17/29	58.6%
3	6	CASTRO H. (ESP)	ESP	5	9/16	6/9	15/25	60.0%
3	9	VUKICEVIC Lazar (MNE)	MNE	6	11/21	4/15	15/36	41.7%
5	10	BASTRICA Nedo (MNE)	MNE	6	8/16	5/7	13/23	56.5%
5	9	KOVACEVIC A. (SRB)	SRB	6	11/21	2/6	13/27	48.1%
5	11	MAS Mathis (FRA)	FRA	5	10/15	3/5	13/20	65.0%
8	10	CANER Guner Ege (TUR)	TUR	4	7/20	5/9	12/29	41.4%
8	2	VUCKOVIC Balsa (MNE)	MNE	6	11/19	1/2	12/21	57.1%
10	7	LOPEZ DUART Robert (ESP)	ESP	5	7/16	4/6	11/22	50.0%
11	11	TARAMASCO Nicola (ITA)	ITA	5	6/14	4/9	10/23	43.5%
11	7	VUKICEVIC Vladan (MNE)	MNE	6	7/13	3/6	10/19	52.6%
13	5	ALMYRAS Andreas (GRE)	GRE	4	7/17	2/6	9/23	39.1%
13	3	DIMITRIJEVIC Marko (SRB)	SRB	6	6/9	3/8	9/17	52.9%
13	5	FRIGOLA M. (ESP)	ESP	5	5/10	4/9	9/19	47.4%
13	4	GAVRILOVIC Bogdan (SRB)	SRB	6	5/8	4/5	9/13	69.2%
13	12	GUERREIRO J. (POR)	POR	4	9/21		9/21	42.9%
18	7	BITSAKOS Christos (GRE)	GRE	4	5/10	3/6	8/16	50.0%
18	6	NENNI Angelo (ITA)	ITA	5	8/11	0/1	8/12	66.7%
18	7	ORNELLAS D. (POR)	POR	4	8/38		8/38	21.1%
18	8	UROSEVIC Viktor (SRB)	SRB	6	6/11	2/6	8/17	47.1%
22	3	BRAGANTINI Matteo (ITA)	ITA	5	5/14	2/10	7/24	29.2%
22	10	BRESCANSKI Boodan (SRB)	SRB	6	7/8		7/8	87.5%
22	2	CANC Matija Bernard (SLO)	SLO	5	4/9	3/4	7/13	53.8%
22	12	KANDANOLEON K. (GRE)	GRE	4	6/6	1/1	7/7	100.0%
22	11	SPACHITS Semir (GRE)	GRE	4	5/8	2/2	7/10	70.0%
22	6	VUKSIC Milos (MNE)	MNE	6	5/11	2/4	7/15	46.7%
28	10	CERAR Aleksander (SLO)	SLO	5	2/11	4/4	6/15	40.0%
28	5	DE SIMON Riccardo (ITA)	ITA	5	2/7	4/7	6/14	42.9%
28	8	KRIVOKAPIC Danilo (MNE)	MNE	6	4/8	2/3	6/11	54.5%
28	10	MATHIEU Manatea (FRA)	FRA	5	5/8	1/4	6/12	50.0%
28	10	MATHIOPOULOS K. (GRE)	GRE	4	3/8	3/8	6/16	37.5%
28	9	PEREZ J. (ESP)	ESP	5	4/6	2/5	6/11	54.5%
28	4	RODRIGUES Clement (FRA)	FRA	5	6/17	0/3	6/20	30.0%
28	6	ROUSSEL Evan (FRA)	FRA	5	4/15	2/7	6/22	27.3%
28	11	STANIC Petar (SRB)	SRB	6	6/11	0/3	6/14	42.9%
37	6	ANDELIC Vuk (SRB)	SRB	6	5/9	0/5	5/14	35.7%
37	3	GIL CEDO Gerard (ESP)	ESP	5	4/10	1/3	5/13	38.5%
37	11	GLIGOROVSKI Lukas (SLO)	SLO	5	5/12	0/2	5/14	35.7%
37	9	MYRILOS Anastasios (GRE)	GRE	4	3/6	2/3	5/9	55.6%
37	7	RAJLIC Nikola (SLO)	SLO	5	5/15	0/1	5/16	31.3%
37	4	TOTTIS Ioannis (GRE)	GRE	4	3/6	2/2	5/8	62.5%
37	2	VILLAMAYOR J. (ESP)	ESP	5	4/6	1/3	5/9	55.6%
44	2	CORA Tommaso (ITA)	ITA	5	3/5	1/2	4/7	57.1%
44	3	ERCIKDI Eren (TUR)	TUR	4	3/14	1/5	4/19	21.1%
44	8	IBANEZ J. (ESP)	ESP	5	3/4	1/4	4/8	50.0%
44	4	IVAYLOV D. (ESP)	ESP	5	2/6	2/6	4/12	33.3%
44	6	KASTRINAKIS N. (GRE)	GRE	4	3/5	1/3	4/8	50.0%
44	5	KRIVOKAPIC Pavle (MNE)	MNE	6	4/8		4/8	50.0%
44	12	MEHDI Adam (FRA)	FRA	5	3/10	1/3	4/13	30.8%
44	4	NIKALJEVIC Milan (MNE)	MNE	6	4/6	0/4	4/10	40.0%
44	11	OTERO J. (ESP)	ESP	5	1/1	3/4	4/5	80.0%
44	8	PAUNOVIC Aleksander (SLO)	SLO	5	4/13	0/3	4/16	25.0%
54	7	DE NARDI Pablo (FRA)	FRA	5	2/13	1/3	3/16	18.8%
54	8	DEFTERAIOS F. (GRE)	GRE	4	3/6	3/6	3/6	50.0%
54	3	FICUR Gasper (SLO)	SLO	5	3/4		3/4	75.0%
54	6	KACIC Tim (SLO)	SLO	5	3/6		3/6	50.0%
54	5	KULOGLU Efe (TUR)	TUR	4	3/11	0/1	3/12	25.0%



## Individual Statistics - Leading Scorers

As of THU 30 JUN 2022 at 14:19

Rank	No.	Name	Team	Match Played	Preliminary Round	Final Rounds	Overall	
					Goals/Shots	Goals/Shots	Goals/Shots	%
54	2	MARAS Mitar (SRB)	SRB	6	1/4	2/6	3/10	30.0%
54	9	MARCENAT Melvyn (FRA)	FRA	5	3/6		3/6	50.0%
54	7	NUZZO Andrea (ITA)	ITA	5	2/9	1/8	3/17	17.6%
54	7	POZNANOVIC Zoran (SRB)	SRB	6	3/4	0/2	3/6	50.0%
54	8	ROCCHINO Mattia (ITA)	ITA	5	3/8	0/2	3/10	30.0%
54	11	SARAC H. (TUR)	TUR	4	1/3	2/4	3/7	42.9%
54	12	STUPAR Danilo (MNE)	MNE	6	2/8	1/5	3/13	23.1%
54	12	URBINATI Andrea (ITA)	ITA	5	2/4	1/5	3/9	33.3%
67	3	BLIEK M. (FRA)	FRA	5	1/4	1/1	2/5	40.0%
67	10	DE LA CRUZ L. (ESP)	ESP	5	1/1	1/1	2/2	100.0%
67	9	GIACOMONE Giorgio (ITA)	ITA	5	0/3	2/5	2/8	25.0%
67	9	GONCALVES G. (POR)	POR	4	2/6		2/6	33.3%
67	9	KOYUNCU Fevzi Emir (TUR)	TUR	4	2/2		2/2	100.0%
67	5	LE GOFF Armand (FRA)	FRA	5	1/6	1/3	2/9	22.2%
67	8	ONDO METHOGO L. (FRA)	FRA	5	1/10	1/4	2/14	14.3%
67	12	RADULOVIC N. (SRB)	SRB	6	1/3	1/2	2/5	40.0%
67	11	SAMARDZIC Drasko (MNE)	MNE	6	2/6	0/3	2/9	22.2%
67	4	SELJAK Jurij (SLO)	SLO	5	2/3		2/3	66.7%
77	8	BAKIR Baran (TUR)	TUR	4	1/2		1/2	50.0%
77	9	CARNI Jost (SLO)	SLO	5	1/3		1/3	33.3%
77	2	CHAPLET Sandro (FRA)	FRA	5	1/2	0/1	1/3	33.3%
77	5	DE OLIVEIRA M. (POR)	POR	4	1/4		1/4	25.0%
77	7	EROKYAR Ege Mert (TUR)	TUR	4	0/3	1/2	1/5	20.0%
77	12	GOMILA FAIGES Biel (ESP)	ESP	5	1/3		1/3	33.3%
77	6	KARABENLI Metin (TUR)	TUR	4	0/2	1/4	1/6	16.7%
77	3	RODRIGUES Afonso (POR)	POR	4	1/7		1/7	14.3%



## Goalkeeper Statistics

As of THU 30 JUN 2022 at 14:19

### Goalkeepers sorted by Country

#### Preliminary Round

Team	Name	No.	MP	Shots on Goal			Penalty Shots on Goal			Counter Attack Assists	Steals
				Saves	Shots	%	Saves	Shots	%		
ESP	GARCIA PLANA Didac	13	3	7	11	63.6	0	1	0.0		
ESP	TECLAS GUILLENA Xavier	1	3	18	38	47.4	0	2	0.0		3
FRA	DUTET Corentin	1	4	17	35	48.6	0	6	0.0		
FRA	VOIGT Yvano	13	4	11	39	28.2	0	3	0.0		2
GRE	ALEIFTIRAS Christos	13	3	10	15	66.7	0	2	0.0		
GRE	DAMIGOS Theodoros	1	3	18	38	47.4	0	2	0.0		1
ITA	VALLE Rocco	1	3	15	32	46.9	1	2	50.0		3
ITA	VALENZA Jason Danny	13	3	0	4	0.0					
MNE	BJELICA Andrija	1	4	12	31	38.7	3	7	42.9		2
MNE	VUKOVIC Dusan	13	4	9	13	69.2					
POR	PEREIRA PIRES Joao Pedro	1	4	9	41	22.0	1	7	14.3		3
POR	VITAL SIMOES JUHOS Vasco Diniz	13	4	12	43	27.9	0	3	0.0		
SLO	LONCAREVIC Alan	13	4	9	12	75.0	0	1	0.0		
SLO	OSEL Neic	1	4	20	54	37.0	1	8	12.5	1	
SRB	PAJKOVIC Petar	1	4	18	29	62.1	2	5	40.0		1
SRB	VIRIJEVIC Radosav	13	4	17	27	63.0					1
TUR	SAHIN Tuğrul Alp	1	3	4	19	21.1	0	1	0.0		
TUR	ZOBU Kagan Yucel	13	3	5	35	14.3	1	4	25.0		

#### Final Rounds

Team	Name	No.	MP	Shots on Goal			Penalty Shots on Goal			Counter Attack Assists	Steals
				Saves	Shots	%	Saves	Shots	%		
ESP	GARCIA PLANA Didac	13	2								
ESP	TECLAS GUILLENA Xavier	1	2	12	27	44.4	0	3	0.0		2
FRA	DUTET Corentin	1	1								
FRA	VOIGT Yvano	13	1	10	19	52.6	0	1	0.0		3
GRE	ALEIFTIRAS Christos	13	1	5	15	33.3	0	2	0.0		
GRE	DAMIGOS Theodoros	1	1								
ITA	VALLE Rocco	1	2	8	25	32.0	0	1	0.0		7
ITA	VALENZA Jason Danny	13	2	1	6	16.7	0	1	0.0		
MNE	BJELICA Andrija	1	2	15	31	48.4	0	2	0.0		
MNE	VUKOVIC Dusan	13	2								
SLO	LONCAREVIC Alan	13	1	1	8	12.5	0	2	0.0		
SLO	OSEL Neic	1	1	4	10	40.0	0	1	0.0		
SRB	PAJKOVIC Petar	1	2								
SRB	VIRIJEVIC Radosav	13	2	19	32	59.4	0	2	0.0		1
TUR	SAHIN Tuğrul Alp	1	1								
TUR	ZOBU Kagan Yucel	13	1	13	23	56.5	1	2	50.0		



## Goalkeeper Statistics

As of THU 30 JUN 2022 at 14:19

### Goalkeepers sorted by Country

Overall(Preliminary+Final Rounds)

Team	Name	No.	MP	Shots on Goal			Penalty Shots on Goal			Counter Attack Assists	Steals
				Saves	Shots	%	Saves	Shots	%		
ESP	GARCIA PLANA Didac	13	5	7	11	63.6	0	1	0.0		
ESP	TECLAS GUILLENA Xavier	1	5	30	65	46.2	0	5	0.0		5
FRA	DUTET Corentin	1	5	17	35	48.6	0	6	0.0		
FRA	VOIGT Yvano	13	5	21	58	36.2	0	4	0.0		5
GRE	ALEIFTIRAS Christos	13	4	15	30	50.0	0	4	0.0		
GRE	DAMIGOS Theodoros	1	4	18	38	47.4	0	2	0.0		1
ITA	VALLE Rocco	1	5	23	57	40.4	1	3	33.3		10
ITA	VALENZA Jason Danny	13	5	1	10	10.0	0	1	0.0		
MNE	BJELICA Andrija	1	6	27	62	43.5	3	9	33.3		2
MNE	VUKOVIC Dusan	13	6	9	13	69.2					
SLO	LONCAREVIC Alan	13	5	10	20	50.0	0	3	0.0		
SLO	OSEL Nejc	1	5	24	64	37.5	1	9	11.1	1	
SRB	PAJKOVIC Petar	1	6	18	29	62.1	2	5	40.0		1
SRB	VIRIJEVIC Radosav	13	6	36	59	61.0	0	2	0.0		2
TUR	SAHIN Tugrul Alp	1	4	4	19	21.1	0	1	0.0		
TUR	ZOBU Kagan Yucel	13	4	18	58	31.0	2	6	33.3		

#### LEGEND

MP Matches Played





## Team Roster

As of SUN 26 JUN 2022 at 18:14

### ESP - Spain

No.	Name	Pos.	L/R	Height m / ft in	Weight kg / lbs	Date of Birth	Age	Club	Int.Matches
1	TECLAS GUILLENA Xavier	GK	R	1,94/6' 4"	84/185	27 JUL 2004	17	CN SABADELL, BARCELONA (ESP)	1
2	VILLAMAYOR I VILLAR Joan	D	R	1,90/6' 3"	83/183	1 APR 2005	17	UE HORTA, BARCELONA (ESP)	2
3	GIL CEDO Gerard	D	R	1,86/6' 1"	86/190	4 JAN 2004	18	CN SABADELL, BARCELONA (ESP)	3
4	IVAYLOV PATCHALIEV Daniel	CB	R	1,88/6' 2"	83/183	28 NOV 2004	17	UE HORTA, BARCELONA (ESP)	4
5	FRIGOLA NAVARRO Marc	CB	R	1,95/6' 5"	83/183	4 MAY 2004	18	CN BARCELONA, BARCELONA (ESP)	5
6	CASTRO FERNANDEZ Hugo	D	R	1,87/6' 2"	83/183	21 JUN 2004	18	UE HORTA, BARCELONA (ESP)	6
7	LOPEZ DUART Robert	D	R	1,85/6' 1"	80/176	27 JAN 2004	18	CN BARCELONETA, BARCELONA (ESP)	7
8	IBANEZ ALVAREZ Javier	D	R	1,90/6' 3"	81/179	18 JUN 2004	18	REAL CANOE NC, MADRID (ESP)	8
9	PEREZ I RODRIGUEZ Jan(C)	CF	R	1,98/6' 6"	93/205	26 JUN 2004	18	CE MEDITERRANI, BARCELONA (ESP)	9
10	DE LA CRUZ COLAPINTO Luca	CB	R	1,83/6' 0"	81/179	23 JAN 2004	18	CN MOLINS DE REI, BARCELONA (ESP)	10
11	OTERO VILLALBA Javier	D	R	1,73/5' 8"	84/185	31 JUL 2004	17	CN LAS PALMAS, LAS PALMAS GC (ES)	11
12	GOMILA FAIGES Biel	CF	R	1,99/6' 6"	108/238	24 FEB 2006	16	CN CATALUÑA, BARCELONA (ESP)	12
13	GARCIA PLANA Didac	GK	R	1,95/6' 5"	88/194	17 JUL 2005	16	CN SANT ANDREU, BARCELONA (ESP)	13

Team Head Coach	SANCHEZ TORIL Javier
Team Assistant Coach	MARTIN LOZANO Jesus
Team Doctor	DAGUERRE GALINDO Jose
Team Physioterapist	LOPEZ CODINA Daniel
Team Leader	OLLE DORCA Antonio

#### LEGEND

(C)	Captain	AR	All-Round	B	Both	CB	Centre Back
CF	Centre Forward	D	Driver	DF	Defender	FP	Field Player
Pos.	Playing Position	R	Right	W	Wing	No.	Number



## Team Roster

As of SUN 26 JUN 2022 at 18:14

### FRA - France

No.	Name	Pos.	L/R	Height m / ft in	Weight kg / lbs	Date of Birth	Age	Club	Int.Matches
1	DUTET Corentin	GK	R	1,90/6 ' 3 "	78/172	3 SEP 2004	17	CN Noisy-le-Sec, Noisy-le-Sec (FRA)	1
2	CHAPLET Sandro		R	1,81/5 ' 11 '	67/148	21 OCT 2005	16	CN Noisy-le-Sec, Noisy-le-Sec (FRA)	3
3	BLIEK PANNETIER Maxime		R	1,80/5 ' 11 '	72/159	10 JAN 2005	17	Montpellier WP, Montpellier (FRA)	2
4	RODRIGUES Clement		R	1,82/6 ' 0 "	78/172	23 JUL 2004	17	CN Noisy-le-Sec, Noisy-le-Sec (FRA)	11
5	LE GOFF Armand		R	1,76/5 ' 9 "	81/179	5 AUG 2005	16	Stade de Reims Natation, Reims (FRA)	5
6	ROUSSEL Evan		R	1,82/6 ' 0 "	85/187	7 SEP 2005	16	Sète Natation, Sète (FRA)	12
7	DE NARDI Pablo		R	1,90/6 ' 3 "	77/170	29 MAR 2004	18	Olympic Nice Natation, Nice (FRA)	4
8	ONDO METHOGO Leandre		R	1,97/6 ' 6 "	82/181	25 OCT 2004	17	CN Noisy-le-Sec, Noisy-le-Sec (FRA)	10
9	MARCENAT Melvyn		R	1,84/6 ' 0 "	84/185	7 APR 2004	18	CN Noisy-le-Sec, Noisy-le-Sec (FRA)	6
10	MATHIEU Manatea		R	1,90/6 ' 3 "	84/185	1 JUN 2005	17	Olympic Nice Natation, Nice (FRA)	8
11	MAS Mathis		R	1,92/6 ' 4 "	90/198	13 MAY 2004	18	CN Marseille, Marseille (FRA)	7
12	MEHDI Adam		R	1,80/5 ' 11 "	80/176	5 JUN 2005	17	Team Strasbourg, Strasbourg (FRA)	9
13	VOIGT Yvano	GK	R	1,90/6 ' 3 "	80/176	13 FEB 2005	17	CN Marseille, Marseille (FRA)	13

Team Head Coach	DONSIMONI Alexandre
Team Assistant Coach	GHESQUIERE Jonathan
Team Doctor	VU-NGON Linh
Team Physioterapist	ROVIRA Christophe
Team Leader	DUHAUTOIS Remi Bruno Claude

#### LEGEND

( C )	Captain	AR	All-Round	B	Both	CB	Centre Back
CF	Centre Forward	D	Driver	DF	Defender	FP	Field Player
Pos.	Playing Position	R	Right	W	Wing	No.	Number



## Team Roster

As of SUN 26 JUN 2022 at 18:14

### GRE - Greece

No.	Name	Pos.	L/R	Height m / ft in	Weight kg / lbs	Date of Birth	Age	Club	Int.Matches
1	DAMIGOS Theodoros	GK		1,94/6' 4"	82/181	8 SEP 2004	17	PERISTERI, ATHENS (GRE)	1
2	TOURKOMENIS Iason	W		1,82/6' 0"	78/172	14 SEP 2004	17	APOLLON ATHENS, ATHENS (GRE)	2
3	NIKOLAIDIS Georgios			1,86/6' 1"	88/194	17 FEB 2005	17		
4	TOTTIS Ioannis			1,83/6' 0"	80/176	1 AUG 2005	16		
5	ALMYRAS Andreas	D		1,80/5' 11"	83/183	9 JAN 2004	18	IDRAIKOS, ATHENS (GRE)	5
6	KASTRINAKIS Nikolaos	CB		1,86/6' 1"	82/181	23 JUN 2004	18	N.C. VOULIAGMENI, ATHENS (GRE)	6
7	BITSAKOS Christos	W		1,83/6' 0"	83/183	30 MAR 2004	18	PERISTERI, ATHENS (GRE)	7
8	DEFTERAIOS Fanourios Foivos	W		1,86/6' 1"	80/176	7 JUN 2004	18	PANATHINAIKOS, ATHENS (GRE)	8
9	MYRILOS Anastasios	CF		1,98/6' 6"	108/238	19 DEC 2004	17	PERISTERI, ATHENS (GRE)	9
10	MATHIOPOULOS Konstantinos	D		1,86/6' 1"	85/187	15 MAR 2004	18	OLYMPIAKOS S.F.P., ATHENS (GRE)	10
11	SPACHITS Semir	D		1,86/6' 1"	110/243	18 NOV 2005	16	N.C. CHANIA, CHANIA (GRE)	12
12	KANDANOLEON Konstantinos	CF		1,84/6' 0"	94/207	16 FEB 2005	17	N.C. CHANIA, CHANIA (GRE)	3
13	ALEIFTIRAS Christos	GK		1,85/6' 1"	78/172	26 MAY 2004	18	PAOK, THESSALONIKI (GRE)	13

Team Head Coach           MACHAIRAS Ilias  
Team Assistant Coach    ANDREAKOS Teo  
Team Physioterapist     APOSTOLOPOULOS Konstantinos

#### LEGEND

( C )	Captain	AR	All-Round	B	Both	CB	Centre Back
CF	Centre Forward	D	Driver	DF	Defender	FP	Field Player
Pos.	Playing Position	R	Right	W	Wing	No.	Number



## Team Roster

As of SUN 26 JUN 2022 at 18:14

### ITA - Italy

No.	Name	Pos.	L/R	Height m / ft in	Weight kg / lbs	Date of Birth	Age	Club	Int.Matches
1	VALLE Rocco	GK				6 JUL 2004	17		
2	CORA Tommaso					3 NOV 2005	16		
3	BRAGANTINI Matteo					4 JUN 2004	18		
4	CAMMAROTA Riccardo					30 SEP 2004	17		
5	DE SIMON Riccardo					10 MAY 2004	18		
6	NENNI Angelo					31 JAN 2004	18		
7	NUZZO Andrea					18 MAR 2005	17		
8	ROCCHINO Mattia					12 AUG 2004	17		
9	GIACOMONE Giorgio					21 SEP 2005	16		
10	CASANOVA Nicolo'					13 JUL 2004	17		
11	TARAMASCO Nicola					25 JUN 2004	18		
12	URBINATI Andrea					12 JUL 2004	17		
13	VALENZA Jason Danny	GK		1,87/6 ' 2 "	78/172	20 NOV 2005	16		

Team Head Coach	ANGELINI Alberto
Team Assistant Coach	BETTINI Daniele
Team Doctor	DAMATO Luca
Team Physioterapist	PERESEMPIO Giorgio
Team Leader	NARDUZZI Maurizio
Team Leader	PANZA Antonello

#### LEGEND

( C )	Captain	AR	All-Round	B	Both	CB	Centre Back
CF	Centre Forward	D	Driver	DF	Defender	FP	Field Player
Pos.	Playing Position	R	Right	W	Wing	No.	Number



## Team Roster

As of SUN 26 JUN 2022 at 18:14

### MNE - Montenegro

No.	Name	Pos.	L/R	Height m / ft in	Weight kg / lbs	Date of Birth	Age	Club	Int.Matches
1	BJELICA Andrija	GK		1,78/5' 10"	73/161	17 JAN 2005	17		
2	VUCKOVIC Balsa			1,76/5' 9"	72/159	14 APR 2005	17		
3	DRAGOVIC Danilo			1,76/5' 9"	74/163	30 JUL 2005	16		
4	NIKALJEVIC Milan					8 APR 2004	18		
5	KRIVOKAPIC Pavle			1,76/5' 9"	72/159	1 JUL 2004	17		
6	VUKSIC Milos			1,79/5' 10"	76/168	25 JUN 2004	18		
7	VUKICEVIC Vladan			1,77/5' 10"	77/170	15 MAR 2004	18		
8	KRIVOKAPIC Danilo			1,76/5' 9"	79/174	7 FEB 2004	18		
9	VUKICEVIC Lazar			1,76/5' 9"	72/159	9 SEP 2004	17		
10	BASTRICA Nedo(C)			1,83/6' 0"	80/176	17 MAY 2004	18		
11	SAMARDZIC Drasko			1,78/5' 10"	74/163	30 MAY 2006	16		
12	STUPAR Danilo			1,77/5' 10"	72/159	9 APR 2007	15		
13	VUKOVIC Dusan	GK		1,78/5' 10"	76/168	23 APR 2005	17		

Team Head Coach	CIROVIC Milan
Team Assistant Coach	MIJANOVIC Nikola
Team Assistant Coach	LOMPAR Vido
Team Physioterapist	KECINA Dusan
Analyst	IVANOVSKI Dusan

#### LEGEND

( C )	Captain	AR	All-Round	B	Both	CB	Centre Back
CF	Centre Forward	D	Driver	DF	Defender	FP	Field Player
Pos.	Playing Position	R	Right	W	Wing	No.	Number



## Team Roster

As of SUN 26 JUN 2022 at 18:14

### POR - Portugal

No.	Name	Pos.	L/R	Height m / ft in	Weight kg / lbs	Date of Birth	Age	Club	Int.Matches
1	PEREIRA PIRES Joao Pedro	GK	R	1,90/6 ' 3 "	73/161	11 JUL 2005	16	SSCMP, Paredes (POR)	1
2	CARVALHO DIAS Antonio	CF	R	1,91/6 ' 3 "	95/209	2 MAR 2005	17	CNPO, Póvoa do Varzim (POR)	2
3	RODRIGUES Afonso	CB	R	1,90/6 ' 3 "	76/168	29 MAY 2004	18	VSC, Guimarães (POR)	8
4	GONCALVES PINA Diogo Manuel	W	R	1,78/5 ' 10 '	66/146	1 DEC 2004	17	CNAC, Coimbra (POR)	4
5	DE OLIVEIRA FONTANA Marco	D	L	1,81/5 ' 11 '	75/165	21 APR 2005	17	SCP, Lisboa (POR)	5
6	ROSA INACIO António Guilherme	CF	R	1,84/6 ' 0 "	75/165	14 MAR 2004	18	SCP, Lisboa (POR)	6
7	ORNELLAS SANTIAGO Diogo	D	R	1,87/6 ' 2 "	84/185	24 MAR 2004	18	CFP, Porto (POR)	7
8	VELOSO SANTOS Rodrigo	W	R	1,72/5 ' 8 "	64/141	8 APR 2005	17	SCP, Lisboa (POR)	3
9	GONCALVES FONTELAS Guilherme	W	R	1,73/5 ' 8 "	65/143	27 MAR 2005	17	SCP, Lisboa (POR)	9
10	FERNANDES MARTINS Rodrigo	CF	R	1,86/6 ' 1 "	97/214	16 JUL 2004	17	VSC, Guimarães (POR)	10
11	FRAGOSO PEREIRA Antonio Daniel	CB	R	1,82/6 ' 0 "	70/154	4 OCT 2005	16	CFP, Porto (POR)	11
12	GUERREIRO MOREIRA Joao(C)	CB	R	1,86/6 ' 1 "	71/157	24 OCT 2004	17	CNPO, Póvoa Varzim (POR)	12
13	VITAL SIMOES JUHOS Vasco Diniz	GK	R	2,00/6 ' 7 "	81/179	21 SEP 2004	17	SCP, Lisboa (POR)	13

Team Head Coach	ABRUNHOSA Gonçalo
Coach	SOARES COSTA Fernando Jorge
Team Assistant Coach	MATOS MAGALHAES Ana Patrícia
Team Leader	RODRIGUES DA CRUZ Jorge Manuel

#### LEGEND

( C )	Captain	AR	All-Round	B	Both	CB	Centre Back
CF	Centre Forward	D	Driver	DF	Defender	FP	Field Player
Pos.	Playing Position	R	Right	W	Wing	No.	Number



## Team Roster

As of SUN 26 JUN 2022 at 18:14

### SLO - Slovenia

No.	Name	Pos.	L/R	Height m / ft in	Weight kg / lbs	Date of Birth	Age	Club	Int.Matches
1	OSEL Nejc	GK	R	1,86/6' 1"	82/181	10 JUN 2005	17	AVK Triglav, Kranj (SLO)	13
2	CANC Matija Bernard		R	1,90/6' 3"	90/198	27 DEC 2004	17	VK Slovan Ljubljana, Ljubljana (SLO)	3
3	FICUR Gasper		R	1,93/6' 4"	108/238	30 JAN 2004	18	VK Koper, Koper (SLO)	6
4	SELJAK Jurij		R	1,84/6' 0"	75/165	9 DEC 2005	16	AVK Branik, Maribor (SLO)	12
5	LAH Jasa		R	1,90/6' 3"	95/209	25 JAN 2004	18	AVK Triglav, Kranj (SLO)	5
6	KACIC Tim		R	1,78/5' 10"	63/139	17 FEB 2005	17	AVK Branik, Maribor (SLO)	4
7	RAJLIC Nikola		R	1,86/6' 1"	84/185	14 DEC 2005	16	AVK Triglav, Kranj (SLO)	7
8	PAUNOVIC Aleksander		R	1,95/6' 5"	100/220	25 FEB 2004	18	AVK Triglav, Kranj (SLO)	8
9	CARNI Jost		R	1,81/5' 11"	85/187	21 JUN 2004	18	VK Slovan Ljubljana, Ljubljana (SLO)	9
10	CERAR Aleksander		R	1,93/6' 4"	94/207	3 JAN 2004	18	Calcit waterpolo, Kamnik (SLO)	10
11	GLIGOROVSKI Lukas		L	1,90/6' 3"	89/196	26 APR 2004	18	VK Valjevo, Valjevo (SRB)	2
12	KODER Samo		R	1,80/5' 11"	75/165	27 NOV 2004	17	VK Gorica, Gorica (SLO)	11
13	LONCAREVIC Alan	GK	R	1,77/5' 10"	66/146	16 NOV 2004	17	VK Koper, Koper (SLO)	1

Team Head Coach SKOF Jure  
Team Assistant Coach HAJDIN Nikola

#### LEGEND

( C )	Captain	AR	All-Round	B	Both	CB	Centre Back
CF	Centre Forward	D	Driver	DF	Defender	FP	Field Player
Pos.	Playing Position	R	Right	W	Wing	No.	Number



## Team Roster

As of SUN 26 JUN 2022 at 18:14

### SRB - Serbia

No.	Name	Pos.	L/R	Height m / ft in	Weight kg / lbs	Date of Birth	Age	Club	Int.Matches
1	PAJKOVIC Petar	GK	R	1,91/6' 3"	90/198	30 JAN 2004	18	VK Vojvodina, Novi Sad (SRB)	1
2	MARAS Mitar			1,88/6' 2"	82/181	5 APR 2004	18		
3	DIMITRIJEVIC Marko	W	L	1,92/6' 4"	88/194	3 APR 2004	18	VK Partizan, Beograd (SRB)	3
4	GAVRILOVIC Bogdan	D	R	1,86/6' 1"	80/176	6 JUN 2004	18	VK Partizan, Beograd (SRB)	4
5	KOJIC Nikola	W	L	1,95/6' 5"	90/198	20 SEP 2004	17	VK Partizan, Beograd (SRB)	5
6	ANDELIC Vuk	W	L	1,85/6' 1"	81/179	28 FEB 2005	17	VK Valis, Valjevo (SRB)	6
7	POZNANOVIC Zoran			1,86/6' 1"	80/176	26 JUN 2004	18		
8	UROSEVIC Viktor	CF	L	1,85/6' 1"	80/176	3 MAR 2004	18	VK Novi Beograd 11 Aril, Beograd (SRB)	8
9	KOVACEVIC Aleksandar	CF	R	1,87/6' 2"	85/187	9 SEP 2004	17	VK Vojvodina, Novi Sad (SRB)	9
10	BRESCANSKI Bogdan	D	R	1,93/6' 4"	90/198	22 FEB 2004	18	VK Vojvodina, Novi Sad (SRB)	10
11	STANIC Petar	CF	R	1,86/6' 1"	82/181	2 MAR 2004	18	VK Sabac, Sabac (SRB)	11
12	RADULOVIC Nikola Vuk			1,87/6' 2"	82/181	19 DEC 2004	17		
13	VIRIJEVIC Radosav	GK	R	1,83/6' 0"	80/176	23 MAR 2004	18	VK Radnicki, Kragujevac (SRB)	13

Team Head Coach	STEVANOVIC Uros
Team Assistant Coach	BILIC Darko
Team Assistant Coach	KOZOMORA Dragan
Physiotherapist	VASOJEVIC Milos
Team General Manager	SAKOVIC Milos

#### LEGEND

( C )	Captain	AR	All-Round	B	Both	CB	Centre Back
CF	Centre Forward	D	Driver	DF	Defender	FP	Field Player
Pos.	Playing Position	R	Right	W	Wing	No.	Number





## Team Roster

As of SUN 26 JUN 2022 at 18:14

### TUR - Turkey

No.	Name	Pos.	L/R	Height m / ft in	Weight kg / lbs	Date of Birth	Age	Club	Int.Matches
1	SAHIN Tugrul Alp	GK				13 APR 2005	17		
2	URLU Yagiz					14 FEB 2005	17		
3	ERCIKDI Eren(C)					29 APR 2005	17		
4	CETIN Eren					31 DEC 2004	17		
5	KULOGLU Efe					29 JAN 2005	17		
6	KARABENLI Metin					12 JAN 2004	18		
7	EROKYAR Ege Mert					29 AUG 2004	17		
8	BAKIR Baran					21 JAN 2004	18		
9	KOYUNCU Fevzi Emir					27 MAR 2004	18		
10	CANER Guner Ege					19 JUL 2004	17		
11	SARAC Hayreddin Burak					24 SEP 2004	17		
12	INCI Berkan					7 APR 2005	17		
13	ZOBU Kagan Yucel	GK				12 DEC 2004	17		

Team Head Coach	OLCAYTU Mehmet Alp
Team Assistant Coach	BATMAZ Ali
Team Assistant Coach	KAHRAMAN Ozgur
Medical Officer	GEDIKLI Ozgul
Team Doctor	TURGAY Demirai
Team Leader	ASCI Huseyin

#### LEGEND

( C )	Captain	AR	All-Round	B	Both	CB	Centre Back
CF	Centre Forward	D	Driver	DF	Defender	FP	Field Player
Pos.	Playing Position	R	Right	W	Wing	No.	Number



ألعاب البحر الأبيض المتوسط  
MEDITERRANEAN GAMES  
JEUX MÉDITERRANÉENS  
du 25 juin au 06 juillet

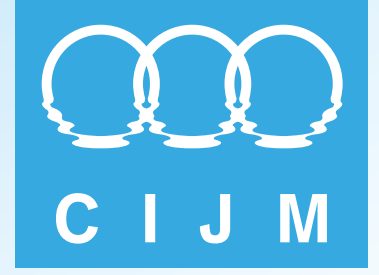

# Results Book



## Wrestling



**TOSYALI  
ALGERIE**

Fer et Acier

سوناطراي



sonarach



microplus  
DATA PROCESSING & TIMING  
[www.microplustiming.com](http://www.microplustiming.com)



## Competition Schedule

As of SUN 26 JUN 2022

Date	Session	Start Time	Estimated Finish Time	Weight Category / Round
SUN 26 JUN	1	10:00	13:00	Men Greco-Roman 60kg Qualification and Elimination Rounds Men Greco-Roman 67kg Qualification and Elimination Rounds Men Greco-Roman 77kg Qualification and Elimination Rounds Men Greco-Roman 87kg Qualification and Elimination Rounds Men Greco-Roman 130kg Preliminary Rounds
	2	17:00	19:00	Men Greco-Roman 60kg Semifinals Men Greco-Roman 67kg Semifinals Men Greco-Roman 77kg Semifinals Men Greco-Roman 87kg Semifinals Men Greco-Roman 130kg Semifinals
MON 27 JUN	3	10:00	13:00	Men Freestyle 57kg Preliminary Rounds Men Freestyle 65kg Qualification and Elimination Rounds Men Greco-Roman 60kg Repechage Men Greco-Roman 77kg Repechage Men Freestyle 74kg Qualification and Elimination Rounds Men Freestyle 86kg Qualification and Elimination Rounds Men Freestyle 97kg Preliminary Rounds
	4	17:00	20:30	Men Freestyle 125kg Qualification and Elimination Rounds Men Freestyle 57kg Semifinals Men Freestyle 65kg Semifinals Men Greco-Roman 60kg Finals Men Greco-Roman 67kg Finals Men Greco-Roman 77kg Finals Men Greco-Roman 87kg Finals Men Greco-Roman 130kg Finals Men Freestyle 74kg Semifinals Men Freestyle 86kg Semifinals Men Freestyle 97kg Semifinals Men Freestyle 125kg Semifinals
TUE 28 JUN	5	10:00	13:00	Women Freestyle 50kg Preliminary Rounds Women Freestyle 53kg Qualification and Elimination Rounds Women Freestyle 57kg Preliminary Rounds Women Freestyle 62kg Preliminary Rounds Women Freestyle 68kg Preliminary Rounds Women Freestyle 76kg Qualification and Elimination Rounds Men Freestyle 65kg Repechage Men Freestyle 86kg Repechage Men Freestyle 125kg Repechage
	6	17:00	20:30	Women Freestyle 50kg Semifinals Women Freestyle 53kg Semifinals Women Freestyle 57kg Semifinals Women Freestyle 62kg Semifinals Women Freestyle 68kg Semifinals Women Freestyle 76kg Semifinals Men Freestyle 57kg Finals Men Freestyle 65kg Finals Men Freestyle 74kg Finals Men Freestyle 86kg Finals Men Freestyle 97kg Finals Men Freestyle 125kg Finals
WED 29 JUN	7	18:00	20:30	Women Freestyle 50kg Finals Women Freestyle 53kg Finals Women Freestyle 57kg Finals



## Competition Schedule

As of SUN 26 JUN 2022

Date	Session	Start Time	Estimated Finish Time	Weight Category / Round
------	---------	------------	-----------------------	-------------------------

Women Freestyle 62kg Finals  
Women Freestyle 68kg Finals  
Women Freestyle 76kg Finals



## Competition Officials

As of SUN 26 JUN 2022

Function	Num Name	Country
Delegate	DOS SANTOS P.	POR - Portugal
Referee	1 BELKACEM TRAI	ALG - Algeria
	2 KHEMAIES BOUAZIZ	TUN - Tunisia
	3 NIKOLA TORBICA	SRB - Serbia
	4 YACINE NAANAA	ALG - Algeria
	5 ABDALLAH ZAIMI	MAR - Morocco
	6 OSMAN SAGIROGLU	TUR - Turkey
	7 GEORGIOS KARAMELAS	GRE - Greece
	8 MOHAMAD ALHAYEK	SYR - Syrian Arab Republic
	9 AHMED HARBI ZERAA	ESP - Spain
	10 SAMI BOUFATIT	ALG - Algeria
	11 MOHAMED JAMEL KHARRAZI	TUN - Tunisia
	12 MAHROUS RAGAB	EGY - Egypt
	13 LAURENT PFIRSCH	FRA - France
	14 LEONEL DUARTE PEDRO	POR - Portugal
	15 MOHAMAD NADER ALSIBAI	SYR - Syrian Arab Republic
	16 TAIEB ZARMEDINI	TUN - Tunisia
	17 DJAMAL BOUTEMTAM	ALG - Algeria
	18 SAVERIO ANTONIO GIRA	ITA - Italy
	19 FAWZI MERDACI	ALG - Algeria
International Technical Official	KAROL LEBKOWSKI	POL - Poland
	VACLAV SCHEINER	CZE - Czech Republic



## Entry List by Country

As of SAT 25 JUN 2022

Country	Name	Gender	Weight Category	Date of Birth
<b>ALB</b>	<b>- Albania</b>			
	ABAKAROV Zelimkhan	Men	Freestyle 65kg	14 JUL 1993
	DUDAEV Islam	Men	Freestyle 74kg	15 JAN 1995
	HAJDARI Osman	Men	Freestyle 86kg	29 MAY 1994
	KUPI Kevin	Men	Greco-Roman 77kg	28 DEC 1999
	PRENGA Gjete	Men	Greco-Roman 67kg	22 NOV 1997
	SINA Bajram	Men	Greco-Roman 60kg	10 JUL 1998
<b>ALG</b>	<b>- Algeria</b>			
	BOUGHEZAL Hadil	Women	Freestyle 76kg	9 NOV 2003
	CHEMLAL Lamia	Women	Freestyle 53kg	6 JUL 1999
	DOUDOU Ibtissem	Women	Freestyle 50kg	20 NOV 1999
	HOUFAF Rayane	Women	Freestyle 57kg	13 FEB 1999
	MERZOUK Thelleli	Women	Freestyle 68kg	16 JUN 2002
	SOUDANI Mastoura	Women	Freestyle 62kg	25 JUL 2003
	BENFERDJALLAH Fateh	Men	Freestyle 86kg	15 APR 2001
	DJEBBARI Abdeldjbar	Men	Greco-Roman 60kg	3 DEC 1998
	FARDJ Mohamed	Men	Freestyle 97kg	19 JUL 1998
	GHAIOU Ishak	Men	Greco-Roman 67kg	24 JAN 1995
	IKKAL Abdelkader	Men	Freestyle 74kg	16 DEC 2000
	KATEB Salah Eddine	Men	Freestyle 57kg	22 JUN 1998
	KHELIL Mohamed Billal	Men	Freestyle 125kg	30 JUN 1993
	KHERBACHE Abdelhak	Men	Freestyle 65kg	25 JUN 1995
	KOUCHIT Hichem	Men	Greco-Roman 130kg	12 DEC 1993
	OUAKALI Abd Elkrim	Men	Greco-Roman 77kg	19 MAR 1993
	SID AZARA Bachir	Men	Greco-Roman 87kg	3 MAR 1996
<b>CRO</b>	<b>- Croatia</b>			
	KAMENJASEVIC Antonio	Men	Greco-Roman 77kg	29 JAN 1997
	LIZATOVIC Ivan	Men	Greco-Roman 60kg	22 NOV 1988
	LUBURIC Vjekoslav	Men	Greco-Roman 87kg	24 JAN 1996
<b>CYP</b>	<b>- Cyprus</b>			
	CHARALAMBOS Choiras	Men	Freestyle 86kg	25 SEP 2002
	KAOSLIDIS Alexios	Men	Freestyle 125kg	1 JAN 1994
<b>EGY</b>	<b>- Egypt</b>			
	HAMZA Samar	Women	Freestyle 76kg	4 APR 1995
	HUSSEIN Farah	Women	Freestyle 57kg	7 APR 2004
	MOHAMED Nada	Women	Freestyle 50kg	16 AUG 2000
	MOHAMED Shaimaa	Women	Freestyle 53kg	6 MAR 2004



## Entry List by Country

As of SAT 25 JUN 2022

Country	Name	Gender	Weight Category	Date of Birth
	ABDELRAHMAN Omar	Men	Greco-Roman 67kg	29 APR 2003
	ABOUELATTA Emad	Men	Greco-Roman 77kg	1 NOV 2001
	BADAWI Mahmoud	Men	Freestyle 86kg	6 APR 1998
	ELDERS Mostafa	Men	Freestyle 97kg	12 DEC 1998
	HAFEZ Yehia	Men	Freestyle 65kg	27 OCT 2002
	HASSAN Nouredin	Men	Greco-Roman 87kg	2 MAR 1998
	HEMIDA Youssif	Men	Freestyle 125kg	13 SEP 1997
	HUSSEN Amr	Men	Freestyle 74kg	26 AUG 1997
	MAHMOUD Haythem	Men	Greco-Roman 60kg	23 SEP 1991
	MOHAMED Abdellatif	Men	Greco-Roman 130kg	8 DEC 1995
	MOHAMED Gamal	Men	Freestyle 57kg	24 FEB 1999
<b>ESP</b>	<b>- Spain</b>			
	GORRIA GONI Aintzane	Women	Freestyle 50kg	7 JUL 1995
	LERA CELDA Carla	Women	Freestyle 76kg	17 MAY 2001
	PAMPIN BLANCO Nerea	Women	Freestyle 68kg	19 NOV 1999
	PEREZ TOURINO Lydia	Women	Freestyle 62kg	17 OCT 1997
	RUEDA FLORES Marina	Women	Freestyle 53kg	13 FEB 1993
	SANCHEZ DIAZ Graciela	Women	Freestyle 57kg	14 SEP 1995
	BOBILLO VIGIL Daniel	Men	Greco-Roman 60kg	16 NOV 1992
	CANADA PANCORBO Alejandro	Men	Freestyle 97kg	21 AUG 1996
	GONZALEZ CRESPO Juan Pablo	Men	Freestyle 65kg	21 JAN 1992
	IGLESIAS VILELA Damian	Men	Freestyle 86kg	28 JUL 1993
	METREVELI VARTANOV Levan	Men	Freestyle 57kg	5 DEC 1984
	SANCHEZ SILVA MEJIAS Marcos	Men	Greco-Roman 77kg	19 OCT 1999
<b>FRA</b>	<b>- France</b>			
	DACHER Kendra	Women	Freestyle 76kg	8 MAY 1999
	DOUARRE Améline	Women	Freestyle 62kg	11 DEC 2000
	LECARPENTIER Pauline	Women	Freestyle 68kg	27 MAY 1997
	LUTTENUAUER Emma	Women	Freestyle 53kg	18 APR 2000
	SABATIE Julie	Women	Freestyle 50kg	24 DEC 1994
	SALAH DEBIEN Tatiana	Women	Freestyle 57kg	30 JAN 1991
	AIBUEV Akhmed	Men	Freestyle 86kg	12 FEB 1991
	BUR Johnny	Men	Greco-Roman 87kg	5 JUN 1995
	DAMOUR Valentin	Men	Freestyle 57kg	28 DEC 1999
	GHANEM Ibrahim	Men	Greco-Roman 77kg	17 APR 1995
	SNJOYAN Gagik	Men	Greco-Roman 67kg	4 NOV 2001
	STICKER Quentin	Men	Freestyle 65kg	8 DEC 1994



## Entry List by Country

As of SAT 25 JUN 2022

Country	Name	Gender	Weight Category	Date of Birth
	TUDEZCA Léo	Men	Greco-Roman 60kg	21 DEC 1993
<b>GRE</b>	<b>- Greece</b>			
	PREVOLARAKI Maria	Women	Freestyle 53kg	21 DEC 1991
	ZACHEILA Stefania	Women	Freestyle 76kg	3 APR 1994
	ALEXANDRIDIS Konstantinos	Men	Freestyle 125kg	27 APR 2002
	NTOUNIAS Nikolaos	Men	Greco-Roman 130kg	16 OCT 2001
	PREVOLARAKIS Georgios	Men	Greco-Roman 77kg	15 OCT 1990
	VLANDOS Nikolaos	Men	Freestyle 57kg	29 JUN 1999
<b>ITA</b>	<b>- Italy</b>			
	CANEVA Dalma	Women	Freestyle 68kg	6 MAY 1994
	DE VITA Morena	Women	Freestyle 57kg	5 APR 2000
	DI DIO Carmen	Women	Freestyle 53kg	13 SEP 2000
	ESPOSITO Elena	Women	Freestyle 62kg	18 MAY 2000
	LIUZZI Emanuela	Women	Freestyle 50kg	27 APR 2000
	RINALDI Enrica	Women	Freestyle 76kg	11 AUG 1998
	CANEVA Aron	Men	Freestyle 86kg	30 MAY 1995
	CONYEDO RUANO Abraham De Jesus	Men	Freestyle 125kg	7 OCT 1993
	IANNATTONI Simone	Men	Freestyle 97kg	23 OCT 1997
	MARVICE Ruben	Men	Greco-Roman 60kg	23 APR 1995
	MASOTTI Jacopo	Men	Freestyle 74kg	21 MAY 1998
	MINGUZZI Mirco	Men	Greco-Roman 87kg	10 MAY 1998
	OBISPADO MORRIS Studd	Men	Freestyle 57kg	19 SEP 2000
	REALBUTO Colin John	Men	Freestyle 65kg	28 MAY 2000
	RUSSO Ciro	Men	Greco-Roman 77kg	14 OCT 1991
	SANFILIPPO Ignazio	Men	Greco-Roman 67kg	5 FEB 1999
	VARICELLI Samuele	Men	Greco-Roman 130kg	11 OCT 1997
<b>KOS</b>	<b>- Kosovo</b>			
	SHALA Egzon	Men	Freestyle 125kg	23 NOV 1990
	SOPA Alban	Men	Freestyle 74kg	9 JUL 1989
<b>MAR</b>	<b>- Morocco</b>			
	HASSOUNE Zineb	Women	Freestyle 53kg	19 JAN 2001
	FAJARI Fouad	Men	Greco-Roman 60kg	18 APR 1989
<b>MK</b>	<b>- Rep. of North Macedonia</b>			
	EGOROV Vladimir	Men	Freestyle 65kg	27 JUN 1995
	NUROV Magomedgadji	Men	Freestyle 97kg	19 APR 1993
	VEJSELI Fati	Men	Freestyle 74kg	31 JAN 1999
<b>POR</b>	<b>- Portugal</b>			





## Entry List by Country

As of SAT 25 JUN 2022

Country	Name	Gender	Weight Category	Date of Birth
SLO	- Slovenia			
	DE MATOS OLIVEIRA Pedro Miguel	Men	Greco-Roman 67kg	12 MAR 1997
SMR	- San Marino			
	GUMILAR Luka	Men	Greco-Roman 77kg	11 AUG 2001
SMR	- San Marino			
	AMINE Malik Michael	Men	Freestyle 74kg	4 JUL 1995
SMR	- San Marino			
	AMINE Myles Nazem	Men	Freestyle 86kg	14 DEC 1996
SRB	- Serbia			
	FABIAN Ana	Women	Freestyle 62kg	7 JAN 1999
SRB	- Serbia			
	DICKOV Zarko	Men	Greco-Roman 87kg	1 DEC 1996
SRB	- Serbia			
	MICIC Stevan	Men	Freestyle 65kg	4 APR 1996
SRB	- Serbia			
	NEMES Viktor	Men	Greco-Roman 77kg	21 JUL 1993
SRB	- Serbia			
	NURASULOV Magomedgadzhi	Men	Freestyle 125kg	15 JUL 1992
SYR	- Syrian Arab Republic			
	ALASTA Mhd Feda Aldin	Men	Freestyle 86kg	30 JAN 1999
SYR	- Syrian Arab Republic			
	ALNAKDALI Ahmad	Men	Greco-Roman 60kg	1 JAN 2001
SYR	- Syrian Arab Republic			
	ALBEID Mohamad	Men	Greco-Roman 77kg	22 MAR 2003
SYR	- Syrian Arab Republic			
	DIRKI Ahmad	Men	Freestyle 65kg	6 MAR 2022
SYR	- Syrian Arab Republic			
	FAWAZ Mohamad	Men	Greco-Roman 67kg	2 OCT 2000
SYR	- Syrian Arab Republic			
	SAREM Omar	Men	Freestyle 125kg	10 MAR 2001
TUN	- Tunisia			
	AMRI Marwa	Women	Freestyle 62kg	8 JAN 1989
TUN	- Tunisia			
	BOUSETA Siwar	Women	Freestyle 57kg	23 JUL 1999
TUN	- Tunisia			
	HAMDI Sarra	Women	Freestyle 50kg	13 MAR 1999
TUN	- Tunisia			
	JLASSI Khadija	Women	Freestyle 68kg	3 JAN 2003
TUN	- Tunisia			
	SGHAIER Zaineb	Women	Freestyle 76kg	25 SEP 2002
TUN	- Tunisia			
	GUENNICHI Amine	Men	Greco-Roman 130kg	16 MAR 1999
TUN	- Tunisia			
	MAAFI Lamjed	Men	Greco-Roman 77kg	19 MAR 2001
TUN	- Tunisia			
	MISSAOUI Mohamed Skander	Men	Greco-Roman 87kg	27 JAN 1989
TUN	- Tunisia			
	SAADAOUI Mohamed	Men	Freestyle 97kg	11 MAY 1995
TUR	- Turkey			
	ADAR YIGIT Yasemin	Women	Freestyle 76kg	6 DEC 1991
TUR	- Turkey			
	GUN Bediha	Women	Freestyle 57kg	26 OCT 1994
TUR	- Turkey			
	TOSUN CAVUSOGLU Buse	Women	Freestyle 68kg	5 DEC 1994
TUR	- Turkey			
	TUGCU Asli	Women	Freestyle 62kg	15 AUG 1996
TUR	- Turkey			
	YAVUZ Evin Demirhan	Women	Freestyle 50kg	2 JUL 1995
TUR	- Turkey			
	YETGIL Zeynep	Women	Freestyle 53kg	10 OCT 2000
TUR	- Turkey			
	AK Samet	Men	Freestyle 74kg	6 AUG 1998



## Entry List by Country

As of SAT 25 JUN 2022

Country Name	Gender	Weight Category	Date of Birth
AKTAS Munir Recep	Men	Freestyle 65kg	26 JUN 1989
AKTURK Feyzullah	Men	Freestyle 97kg	1 JAN 1999
CENGIZ Ali	Men	Greco-Roman 87kg	8 APR 1996
ERCAN Salim	Men	Freestyle 125kg	10 MAR 1996
ERDIN Fatih	Men	Freestyle 86kg	1 FEB 1994
FIRAT Murat	Men	Greco-Roman 67kg	23 SEP 1997
KAMAL Kerem	Men	Greco-Roman 60kg	10 AUG 1999
KARAVUS Muhammed	Men	Freestyle 57kg	10 JUN 2002
YILDIRIM Osman	Men	Greco-Roman 130kg	25 MAR 1996
YILMAZ Ahmet	Men	Greco-Roman 77kg	2 FEB 1996



## Number of Entries by Country

### Women's Freestyle

As of SAT 25 JUN 2022

Code	Country	Total entries by weight category						Total
		FS50	FS53	FS57	FS62	FS68	FS76	Athletes
ALG	Algeria	1	1	1	1	1	1	6
EGY	Egypt	1	1	1			1	4
ESP	Spain	1	1	1	1	1	1	6
FRA	France	1	1	1	1	1	1	6
GRE	Greece		1				1	2
ITA	Italy	1	1	1	1	1	1	6
MAR	Morocco		1					1
SRB	Serbia				1			1
TUN	Tunisia	1		1	1	1	1	5
TUR	Turkey	1	1	1	1	1	1	6
	Total: 10	7	8	7	7	6	8	43



## Number of Entries by Country

### Men's Freestyle

As of SAT 25 JUN 2022

Code	Country	Total entries by weight category					Total Athletes
		FS57	FS65	FS74	FS86	FS97	
ALB	Albania		1	1	1		3
ALG	Algeria	1	1	1	1	1	6
CYP	Cyprus				1		2
EGY	Egypt	1	1	1	1	1	6
ESP	Spain	1	1		1	1	4
FRA	France	1	1		1		3
GRE	Greece	1					2
ITA	Italy	1	1	1	1	1	6
KOS	Kosovo			1			2
MKD	Rep. of North Macedonia		1	1		1	3
SMR	San Marino			1	1		2
SRB	Serbia		1				2
SYR	Syrian Arab Republic		1		1		3
TUN	Tunisia					1	1
TUR	Turkey	1	1	1	1	1	6
	Total: 15	7	10	8	10	7	51



## Number of Entries by Country

### Men's Greco-Roman

As of SAT 25 JUN 2022

Code	Country	Total entries by weight category					Total Athletes
		GR60	GR67	GR77	GR87	GR130	
ALB	Albania	1	1	1			3
ALG	Algeria	1	1	1	1	1	5
CRO	Croatia	1		1	1		3
EGY	Egypt	1	1	1	1	1	5
ESP	Spain	1		1			2
FRA	France	1	1	1	1		4
GRE	Greece			1		1	2
ITA	Italy	1	1	1	1	1	5
MAR	Morocco	1					1
POR	Portugal		1				1
SLO	Slovenia			1			1
SRB	Serbia			1	1		2
SYR	Syrian Arab Republic	1	1	1			3
TUN	Tunisia			1	1	1	3
TUR	Turkey	1	1	1	1	1	5
	Total: 15	10	8	13	8	6	45

**Medallists by Event**

As of WED 29 JUN 2022 at 21:50

After 17 of 17 Events

Event	Date	Medal	Name	Country Code
Women Freestyle 50kg	WED 29 JUN 202	GOLD	YAVUZ Evin Demirhan	TUR
		SILVER	SABATIE Julie	FRA
		BRONZE	HAMDY Sarra	TUN
Women Freestyle 53kg	WED 29 JUN 202	GOLD	PREVOLARAKI Maria	GRE
		SILVER	YETGIL Zeynep	TUR
		BRONZE	RUEDA FLORES Marina	ESP
		BRONZE	MOHAMED Shaimaa	EGY
Women Freestyle 57kg	WED 29 JUN 202	GOLD	GÜN Bediha	TUR
		SILVER	BOUSETA Siwar	TUN
		BRONZE	SALAH DEBIEN Tatiana	FRA
Women Freestyle 62kg	WED 29 JUN 202	GOLD	AMRI Marwa	TUN
		SILVER	DOUARRE Ameline	FRA
		BRONZE	PEREZ TOURINO Lydia	ESP
Women Freestyle 68kg	WED 29 JUN 202	GOLD	LECARPENTIER Pauline	FRA
		SILVER	TOSUN CAVUSOGLU Buse	TUR
		BRONZE	CANEVA Dalma	ITA
Women Freestyle 76kg	WED 29 JUN 202	GOLD	ADAR YIGIT Yasemin	TUR
		SILVER	RINALDI Enrica	ITA
		BRONZE	DACHER Kendra	FRA
		BRONZE	HAMZA Samar	EGY
Men Freestyle 125kg	TUE 28 JUN 202	GOLD	NURASULOV Magomedgadzi	SRB
		SILVER	CONYEDO RUANO Abraham De Jesus	ITA
		BRONZE	ERCAN Salim	TUR
		BRONZE	HEMIDA Youssif	EGY
Men Freestyle 57kg	TUE 28 JUN 202	GOLD	KARAVUS Muhammed	TUR
		SILVER	METREVELI VARTANOV Levan	ESP
		BRONZE	OBISPADO MORRIS Studd	ITA
Men Freestyle 65kg	TUE 28 JUN 202	GOLD	ABAKAROV Zelimkhan	ALB
		SILVER	HAFEZ Yehia	EGY
		BRONZE	MICIC Stevan	SRB
		BRONZE	EGOROV Vladimir	MKD
Men Freestyle 74kg	TUE 28 JUN 202	GOLD	HUSSEN Amr	EGY
		SILVER	AK Samet	TUR
		BRONZE	AMINE Malik Michael	SMR
		BRONZE	DUDAEV Islam	ALB
Men Freestyle 86kg	TUE 28 JUN 202	GOLD	AMINE Myles Nazem	SMR
		SILVER	ERDIN Fatih	TUR
		BRONZE	CHARALAMBOS Choiras	CYP
		BRONZE	AIBUEV Akhmed	FRA
Men Freestyle 97kg	TUE 28 JUN 202	GOLD	NUROV Magomedgadji	MKD
		SILVER	AKTURK Feyzullah	TUR
		BRONZE	SAADAOUI Mohamed	TUN
Men Greco-Roman 130kg	MON 27 JUN 20	GOLD	YILDIRIM Osman	TUR
		SILVER	MOHAMED Abdellatif	EGY
		BRONZE	GUENNICHI Amine	TUN



## Medallists by Event

As of WED 29 JUN 2022 at 21:50

After 17 of 17 Events

Event	Date	Medal	Name	Country Code
Men Greco-Roman 60kg	MON 27 JUN 20	GOLD	KAMAL Kerem	TUR
		SILVER	TUDEZCA Leo	FRA
		BRONZE	MAHMOUD Haythem	EGY
		BRONZE	MARVICE Ruben	ITA
Men Greco-Roman 67kg	MON 27 JUN 20	GOLD	FIRAT Murat	TUR
		SILVER	GHAIOU Ishak	ALG
		BRONZE	ABDELRAHMAN Omar	EGY
		BRONZE	SNJOYAN Gagik	FRA
Men Greco-Roman 77kg	MON 27 JUN 20	GOLD	NEMES Viktor	SRB
		SILVER	OOUAKALI Abd Elkrim	ALG
		BRONZE	KAMENJASEVIC Antonio	CRO
		BRONZE	PREVOLARAKIS Georgios	GRE
Men Greco-Roman 87kg	MON 27 JUN 20	GOLD	SID AZARA Bachir	ALG
		SILVER	MINGUZZI Mirco	ITA
		BRONZE	CENGIZ Ali	TUR
		BRONZE	HASSAN Noureldin	EGY



## Medal Standings

As of WED 29 JUN 2022 at 21:50

After 17 of 17 Events

Rank	Country	Men				Women				Total				Rank by total
		G	S	B	Tot	G	S	B	Tot	G	S	B	Tot	
1	TUR - Turkiye	4	3	2	9	3	2		5	7	5	2	14	1
2	SRB - Serbia	2		1	3					2		1	3	= 6
3	FRA - France		1	2	3	1	2	2	5	1	3	4	8	3
4	EGY - Egypt	1	2	4	7			2	2	1	2	6	9	2
5	ALG - Algeria	1	2		3					1	2		3	= 6
6	TUN - Tunisia			2	2	1	1	1	3	1	1	3	5	5
7	ALB - Albania	1		1	2					1		1	2	= 9
7	GRE - Greece			1	1	1			1	1		1	2	= 9
7	MKD - Rep. of North Macedonia	1		1	2					1		1	2	= 9
7	SMR - San Marino	1		1	2					1		1	2	= 9
11	ITA - Italy		2	2	4		1	1	2		3	3	6	4
12	ESP - Spain		1		1			2	2		1	2	3	= 6
13	CRO - Croatia			1	1							1	1	= 13
13	CYP - Cyprus			1	1							1	1	= 13
	<b>Total:</b>	<b>11</b>	<b>11</b>	<b>19</b>	<b>41</b>	<b>6</b>	<b>6</b>	<b>8</b>	<b>20</b>	<b>17</b>	<b>17</b>	<b>27</b>	<b>61</b>	

### LEGEND

= Equal sign indicates that two or more  
 Tot Total  
 B Bronze  
 G Gold  
 S Silver





## Final Classification by Event

As of WED 29 JUN 2022 at 21:50

Rank	Name	Country Cod
<b>Women's Freestyle 50kg</b>		
Gold	YAVUZ Evin Demirhan	TUR
Silver	SABATIE Julie	FRA
Bronze	HAMDJ Sarra	TUN
4	LIUZZI Emanuela	ITA
5	GORRIA GONI Aintzane	ESP
6	DOUDOU Ibtissem	ALG
7	MOHAMED Nada	EGY
<b>Women's Freestyle 53kg</b>		
Gold	PREVOLARAKI Maria	GRE
Silver	YETGIL Zeynep	TUR
Bronze	RUEDA FLORES Marina	ESP
Bronze	MOHAMED Shaimaa	EGY
5	LUTTENAUER Emma	FRA
5	DI DIO Carmen	ITA
7	CHEMLAL Lamia	ALG
8	HASSOUNE Zineb	MAR
<b>Women's Freestyle 57kg</b>		
Gold	GUN Bediha	TUR
Silver	BOUSETA Siwar	TUN
Bronze	SALAH DEBIEN Tatiana	FRA
4	SANCHEZ DIAZ Graciela	ESP
5	HOUFAF Ravane	ALG
6	HUSSEIN Farah	EGY
<b>Women's Freestyle 62kg</b>		
Gold	AMRI Marwa	TUN
Silver	DOUARRE Ameline	FRA
Bronze	PEREZ TOURINO Lydia	ESP
4	SOUDANI Mastoura	ALG
5	TUGCU Asli	TUR
6	FABIAN Ana	SRB
7	ESPOSITO Elena	ITA
<b>Women's Freestyle 68kg</b>		
Gold	LECARPENTIER Pauline	FRA
Silver	TOSUN CAVUSOGLU Buse	TUR
Bronze	CANEVA Dalma	ITA
4	JLASSI Khadija	TUN
5	PAMPIN BLANCO Nerea	ESP
6	MERZOUK Thelleli	ALG
<b>Women's Freestyle 76kg</b>		
Gold	ADAR YIGIT Yasemin	TUR
Silver	RINALDI Enrica	ITA
Bronze	DACHER Kendra	FRA
Bronze	HAMZA Samar	EGY
5	ZACHEILA Stefania	GRE
5	LERA CELDA Carla	ESP
7	SGHAIER Zaineb	TUN
8	BOUGHEZAL Hadil	ALG



## Final Classification by Event

As of WED 29 JUN 2022 at 21:50

Rank	Name	Country Cod
<b>Men's Freestyle 57kg</b>		
Gold	KARAVUS Muhammed	TUR
Silver	METREVELI VARTANOV Levan	ESP
Bronze	OBISPADO MORRIS Studd	ITA
4	DAMOUR Valentin	FRA
5	MOHAMED Gamal	EGY
6	KATEB Salah Eddine	ALG
7	VLANDOS Nikolaos	GRE
EV	KATEB Salah Eddine	ALG
<b>Men's Freestyle 65kg</b>		
Gold	ABAKAROV Zelimkhan	ALB
Silver	HAFEZ Yehia	EGY
Bronze	MICIC Stevan	SRB
Bronze	EGOROV Vladimir	MKD
5	AKTAS Munir Recep	TUR
5	KHERBACHE Abdelhak	ALG
7	DIRKI Ahmad	SYR
8	REALBUTO Colin John	ITA
9	GONZALEZ CRESPO Juan Pablo	ESP
10	STICKER Quentin	FRA
<b>Men's Greco-Roman 60kg</b>		
Gold	KAMAL Kerem	TUR
Silver	TUDEZCA Leo	FRA
Bronze	MAHMOUD Haythem	EGY
Bronze	MARVICE Ruben	ITA
5	LIZATOVIC Ivan	CRO
6	FAJARI Fouad	MAR
7	BOBILLO VIGIL Daniel	ESP
8	DJEBBARI Abdeldjibar	ALG
9	SINA Bajram	ALB
EV	ALNAKDALI Ahmad	SYR
<b>Men's Greco-Roman 67kg</b>		
Gold	FIRAT Murat	TUR
Silver	GHAIOU Ishak	ALG
Bronze	ABDELRAHMAN Omar	EGY
Bronze	SNJOYAN Gagik	FRA
5	DE MATOS OLIVEIRA Pedro Miquel	POR
5	SANFILIPPO Ignazio	ITA
7	FAWAZ Mohamad	SYR
8	PRENGA Gjete	ALB
<b>Men's Greco-Roman 77kg</b>		
Gold	NEMES Viktor	SRB
Silver	OUAKALI Abd Elkrim	ALG
Bronze	KAMENJASEVIC Antonio	CRO
Bronze	PREVOLARAKIS Georgios	GRE
5	RUSSO Ciro	ITA
5	ABOUELATTA Emad	EGY
7	KUPI Kevin	ALB
8	MAAFI Lamjed	TUN
9	SANCHEZ SILVA MEJIAS Marcos	ESP
10	YILMAZ Ahmet	TUR
11	GHANEM Ibrahim	FRA
12	ALBEID Mohamad	SYR
13	GUMILAR Luka	SLO



## Final Classification by Event

As of WED 29 JUN 2022 at 21:50

Rank	Name	Country Cod
<b>Men's Greco-Roman 87kg</b>		
	Gold SID AZARA Bachir	ALG
	Silver MINGUZZI Mirco	ITA
	Bronze CENGIZ Ali	TUR
	Bronze HASSAN Noureldin	EGY
	5 BUR Johnny	FRA
	5 DICKOV Zarko	SRB
	7 LUBURIC Vjekoslav	CRO
	8 MISSAOUI Mohamed Skander	TUN
<b>Men's Greco-Roman 130kg</b>		
	Gold YILDIRIM Osman	TUR
	Silver MOHAMED Abdellatif	EGY
	Bronze GUENNICHI Amine	TUN
	4 KOUCHIT Hichem	ALG
	5 NTOUNIAS Nikolaos	GRE
	6 VARICELLI Samuele	ITA
<b>Men's Freestyle 74kg</b>		
	Gold HUSSEN Amr	EGY
	Silver AK Samet	TUR
	Bronze AMINE Malik Michael	SMR
	Bronze DUDAEV Islam	ALB
	5 MASOTTI Jacopo	ITA
	5 IKKAL Abdelkader	ALG
	7 VEJSELI Fati	MKD
	8 SOPA Alban	KOS
<b>Men's Freestyle 86kg</b>		
	Gold AMINE Myles Nazem	SMR
	Silver ERDIN Fatih	TUR
	Bronze CHARALAMBOS Choiras	CYP
	Bronze AIBUEV Akhmed	FRA
	5 HAJDARI Osman	ALB
	5 BENFERDJALLAH Fateh	ALG
	7 BADAWI Mahmoud	EGY
	8 IGLESIAS VILELA Damian	ESP
	9 CANEVA Aron	ITA
	10 ALASTA Mhd Feda Aldin	SYR
<b>Men's Freestyle 97kg</b>		
	Gold NUROV Maqomedqadij	MKD
	Silver AKTURK Feyzullah	TUR
	Bronze SAADAQUI Mohamed	TUN
	4 ELDERS Mostafa	EGY
	5 CANADA PANCORBO Alejandro	ESP
	6 FARDJ Mohamed	ALG
	7 IANNATTONI Simone	ITA



## Final Classification by Event

As of WED 29 JUN 2022 at 21:50

Rank	Name	Country Cod
<b>Men's Freestyle 125kg</b>		
Gold	NURASULOV Maqomedqadzhi	SRB
Silver	CONYEDO RUANO Abraham De Jesus	ITA
Bronze	ERCAN Salim	TUR
Bronze	HEMIDA Youssif	EGY
5	KHELIL Mohamed Billal	ALG
5	ALEXANDRIDIS Konstantinos	GRE
7	KAOSLIDIS Alexios	CYP
8	SAREM Omar	SYR
9	SHALA Egzon	KOS



26 JUN 2022

Start time 10:00

Session 1

## Session Results

MAT A										
Event Short Name	Match No.	Round	Colour	Draw No.	Name	Ctry Code	Tech. Pts.	Class. Pts.	Res. Code	Officials
MGR GR130	1	Preliminary	Red	2	NTOUNIAS Nikolaos	GRE	1	1	VSU1	
			Blue	6	YILDIRIM Osman	TUR	9	4		
MGR GR77K	2	1/8 Final	Red	6	PREVOLARAKIS Georgios	GRE	3	3	VPO1	
			Blue	7	YILMAZ Ahmet	TUR	3	1		
MGR GR77K	3	1/8 Final	Red	12	NEMES Viktor	SRB	9	4	VSU	
			Blue	13	ABOUELATTA Emad	EGY	0	0		
MGR GR67K	4	Quarter-finals	Red	2	GHAIOU Ishak	ALG	7	3	VPO1	
			Blue	3	DE MATOS OLIVEIRA Pedro Miguel	POR	1	1		
MGR GR67K	5	Quarter-finals	Red	12	SNJOYAN Gagik	FRA	3	1	VPO1	
			Blue	13	FIRAT Murat	TUR	6	3		
MGR GR87K	6	Quarter-finals	Red	1	BUR Johnny	FRA	0	0	VPO	
			Blue	2	SID AZARA Bachir	ALG	3	3		
MGR GR87K	7	Quarter-finals	Red	10	DICKOV Zarko	SRB	3	1	VPO1	
			Blue	13	MINGUZZI Mirco	ITA	6	3		
MGR GR77K	8	Quarter-finals	Red	6	PREVOLARAKIS Georgios	GRE	14	4	VSU1	
			Blue	8	MAAFI Lamjed	TUN	4	1		
MGR GR60K	9	Quarter-finals	Red	3	MAHMOUD Haythem	EGY	6	1	VPO1	
			Blue	4	KAMAL Kerem	TUR	7	3		
MGR GR130	10	Preliminary	Red	6	YILDIRIM Osman	TUR	3	3	VPO1	
			Blue	9	MOHAMED Abdellatif	EGY	1	1		



26 JUN 2022

Start time 10:00

Session 1

## Session Results

MAT B										
Event Short Name	Match No.	Round	Colour	Draw No.	Name	Ctry Code	Tech. Pts.	Class. Pts.	Res. Code	Officials
MGR GR130	11	Preliminary	Red	4	KOUCHIT Hichem	ALG	1	0	VFA	
			Blue	8	GUENNICHI Amine	TUN	5	5		
MGR GR77K	12	1/8 Final	Red	8	MAAFI Lamjed	TUN	5	3	VPO1	
			Blue	9	GHANEM Ibrahim	FRA	3	1		
MGR GR60K	13	1/8 Final	Red	8	MARVICE Ruben	ITA	6	3	VPO1	
			Blue	10	BOBILLO VIGIL Daniel	ESP	2	1		
MGR GR67K	14	Quarter-finals	Red	4	ABDELRAHMAN Omar	EGY	9	4	VSU	
			Blue	5	PRENGA Gjete	ALB	0	0		
MGR GR130	15	Preliminary	Red	9	MOHAMED Abdellatif	EGY	8	4	VSU	
			Blue	2	NTOUNIAS Nikolaos	GRE	0	0		
MGR GR87K	16	Quarter-finals	Red	4	LUBURIC Vjekoslav	CRO	3	1	VPO1	
			Blue	5	CENGIZ Ali	TUR	6	3		
MGR GR77K	17	Quarter-finals	Red	1	ALOBED Mohamad	SYR	0	0	VSU	
			Blue	2	KAMENJASEVIC Antonio	CRO	9	4		
MGR GR77K	18	Quarter-finals	Red	10	KUPI Kevin	ALB	1	1	VSU1	
			Blue	12	NEMES Viktor	SRB	10	4		
MGR GR60K	19	Quarter-finals	Red	6	SINA Bajram	ALB	0	0	VSU	
			Blue	7	ALNAKDALI Ahmad	SYR	9	4		
MGR GR130	20	Preliminary	Red	8	GUENNICHI Amine	TUN	9	4	VSU	
			Blue	13	VARICELLI Samuele	ITA	0	0		



26 JUN 2022

Start time 10:00

Session 1

### Session Results

MAT C										
Event Short Name	Match No.	Round	Colour	Draw No.	Name	Ctry Code	Tech. Pts.	Class. Pts.	Res. Code	Officials
MGR GR77K	21	1/8 Final	Red	4	SANCHEZ SILVA MEJIAS Marcos	ESP	2	1	VSU1	
			Blue	5	OOUAKALI Abd Elkrim	ALG	10	4		
MGR GR77K	22	1/8 Final	Red	10	KUPI Kevin	ALB	10	4	VSU	
			Blue	11	GUMILAR Luka	SLO	0	0		
MGR GR60K	23	1/8 Final	Red	11	FAJARI Fouad	MAR	3	1	VPO1	
			Blue	12	TUDEZCA Leo	FRA	4	3		
MGR GR67K	24	Quarter-finals	Red	6	SANFILIPPO Ignazio	ITA	8	4	VSU	
			Blue	8	FAWAZ Mohamad	SYR	0	0		
MGR GR130	25	Preliminary	Red	13	VARICELLI Samuele	ITA	0	0	VSU	
			Blue	4	KOUCHIT Hichem	ALG	9	4		
MGR GR87K	26	Quarter-finals	Red	6	MISSAOUI Mohamed Skander	TUN	0	0	VSU	
			Blue	9	HASSAN Nouredin	EGY	9	4		
MGR GR77K	27	Quarter-finals	Red	3	RUSSO Ciro	ITA	0	0	VFA	
			Blue	5	OOUAKALI Abd Elkrim	ALG	8	5		
MGR GR60K	28	Quarter-finals	Red	1	DJEBBARI Abdeldjbar	ALG	0	0	VSU	
			Blue	2	LIZATOVIC Ivan	CRO	9	4		
MGR GR60K	29	Quarter-finals	Red	8	MARVICE Ruben	ITA	3	1	VPO1	
			Blue	12	TUDEZCA Leo	FRA	5	3		



26 JUN 2022

## Session Results

Start time 17:00

Session 2

MAT A										
Event Short Name	Match No.	Round	Colour	Draw No.	Name	Ctry Code	Tech. Pts.	Class. Pts.	Res. Code	Officials
MGR GR60K	30	Semi-finals	Red	2	LIZATOVIC Ivan	CRO	1	1	VSU1	
			Blue	4	KAMAL Kerem	TUR	9	4		
MGR GR67K	31	Semi-finals	Red	2	GHAIOU Ishak	ALG	3	3	VPO1	
			Blue	4	ABDELRAHMAN Omar	EGY	1	1		
MGR GR77K	32	Semi-finals	Red	2	KAMENJASEVIC Antonio	CRO	3	0	VSU	
			Blue	5	OOUAKALI Abd Elkrim	ALG	12	4		
MGR GR87K	33	Semi-finals	Red	2	SID AZARA Bachir	ALG	4	3	VPO	
			Blue	5	CENGIZ Ali	TUR	0	0		
MGR GR130	34	Semi-finals	Red	6	YILDIRIM Osman	TUR	8	4	VSU	
			Blue	4	KOUCHIT Hichem	ALG	0	0		





26 JUN 2022

Start time 17:00

Session 2

## Session Results

MAT B										
Event Short Name	Match No.	Round	Colour	Draw No.	Name	Ctry Code	Tech. Pts.	Class. Pts.	Res. Code	Officials
MGR GR60K	35	Semi-finals	Red	7	ALNAKDALI Ahmad	SYR	7	0	VFA	
			Blue	12	TUDEZCA Leo	FRA	12	5		
MGR GR67K	36	Semi-finals	Red	6	SANFILIPPO Ignazio	ITA	1	1	VPO1	
			Blue	13	FIRAT Murat	TUR	6	3		
MGR GR77K	37	Semi-finals	Red	6	PREVOLARAKIS Georgios	GRE	0	0	VSU	
			Blue	12	NEMES Viktor	SRB	9	4		
MGR GR87K	38	Semi-finals	Red	9	HASSAN Noureldin	EGY	3	1	VPO1	
			Blue	13	MINGUZZI Mirco	ITA	7	3		
MGR GR130	39	Semi-finals	Red	9	MOHAMED Abdellatif	EGY	2	3	VPO	
			Blue	8	GUENNICHI Amine	TUN	0	0		



27 JUN 2022

Start time 10:00

Session 3

**Session Results**

MAT A										
Event Short Name	Match No.	Round	Colour	Draw No.	Name	Ctry Code	Tech. Pts.	Class. Pts.	Res. Code	Officials
MFR FS57Kg	40	Preliminary	Red	2	MOHAMED Gamal	EGY	1	1	VSU1	
			Blue	6	DAMOUR Valentin	FRA	12	4		
MFR FS97Kg	41	Preliminary	Red	1	NUROV Magomedgadji	MKD	13	4	VSU1	
			Blue	6	SAADAOUJ Mohamed	TUN	2	1		
MFR FS65Kg	42	1/8 Final	Red	7	GONZALEZ CRESPO Juan Pablo	ESP	2	1	VPO1	
			Blue	8	KHERBACHE Abdelhak	ALG	2	3		
MFR FS86Kg	43	1/8 Final	Red	12	AIBUEV Akhmed	FRA	1	1	VPO1	
			Blue	13	AMINE Myles Nazem	SMR	6	3		
MFR FS74Kg	44	Quarter-finals	Red	6	MASOTTI Jacopo	ITA	4	3	VPO	
			Blue	7	SOPA Alban	KOS	0	0		
MFR FS57Kg	45	Preliminary	Red	2	MOHAMED Gamal	EGY	10	4	VSU	
			Blue	8	VLANDOS Nikolaos	GRE	0	0		
MFR FS97Kg	46	Preliminary	Red	1	NUROV Magomedgadji	MKD	10	5	VFA	
			Blue	9	FARDJ Mohamed	ALG	0	0		
MFR FS65Kg	47	Quarter-finals	Red	1	AKTAS Munir Recep	TUR	4	1	VPO1	
			Blue	2	ABAKAROV Zelimkhan	ALB	8	3		
MFR FS65Kg	48	Quarter-finals	Red	8	KHERBACHE Abdelhak	ALG	6	3	VPO1	
			Blue	12	DIRKI Ahmad	SYR	5	1		
MFR FS86Kg	49	Quarter-finals	Red	6	CANEVA Aron	ITA	1	1	VPO1	
			Blue	8	BENFERDJALLAH Fateh	ALG	5	3		
MFR FS125K	50	Quarter-finals	Red	5	KHELIL Mohamed Billal	ALG	0	0	VSU	
			Blue	6	NURASULOV Magomedgadzhi	SRB	10	4		
MFR FS57Kg	51	Preliminary	Red	13	OBISPADO MORRIS Studd	ITA	10	3	VPO1	
			Blue	2	MOHAMED Gamal	EGY	5	1		
MFR FS97Kg	52	Preliminary	Red	11	CANADA PANCORBO Alejandro	ESP	0	0	VSU	
			Blue	1	NUROV Magomedgadji	MKD	10	4		
MGR GR77K	54	Repechage Round 1	Red	13	ABOUELATTA Emad	EGY	9	4	VSU	
			Blue	10	KUPI Kevin	ALB	0	0		



27 JUN 2022

Start time 10:00

Session 3

## Session Results

MAT B										
Event Short Name	Match No.	Round	Colour	Draw No.	Name	Ctry Code	Tech. Pts.	Class. Pts.	Res. Code	Officials
MFR FS57Kg	55	Preliminary	Red	8	VLANDOS Nikolaos	GRE	0	0	VFA	
			Blue	13	OBISPADO MORRIS Studd	ITA	6	5		
MFR FS97Kg	56	Preliminary	Red	9	FARDJ Mohamed	ALG	0	0	VPO	
			Blue	11	CANADA PANCORBO Alejandro	ESP	4	3		
MFR FS65Kg	57	1/8 Final	Red	11	REALBUTO Colin John	ITA	4	1	VPO1	
			Blue	12	DIRKI Ahmad	SYR	7	3		
MFR FS125K	58	1/8 Final	Red	11	KAOUSLIDIS Alexios	CYP	4	3	VPO	
			Blue	12	SAREM Omar	SYR	0	0		
MFR FS74Kg	59	Quarter-finals	Red	9	IKKAL Abdelkader	ALG	3	3	VPO1	
			Blue	11	VEJSELI Fati	MKD	2	1		
MFR FS57Kg	60	Preliminary	Red	6	DAMOUR Valentin	FRA	8	3	VPO1	
			Blue	13	OBISPADO MORRIS Studd	ITA	2	1		
MFR FS97Kg	61	Preliminary	Red	6	SAADAOUI Mohamed	TUN	6	3	VPO1	
			Blue	11	CANADA PANCORBO Alejandro	ESP	2	1		
MFR FS65Kg	62	Quarter-finals	Red	3	MICIC Stevan	SRB	10	4	VSU	
			Blue	4	STICKER Quentin	FRA	0	0		
MFR FS86Kg	63	Quarter-finals	Red	1	IGLESIAS VILELA Damian	ESP	2	1	VPO1	
			Blue	2	HAJDARI Osman	ALB	3	3		
MFR FS86Kg	64	Quarter-finals	Red	9	BADAWI Mahmoud	EGY	0	0	VSU	
			Blue	13	AMINE Myles Nazem	SMR	10	4		
MFR FS125K	65	Quarter-finals	Red	7	CONYEDO RUANO Abraham De Jesu	ITA	12	4	VSU1	
			Blue	9	ALEXANDRIDIS Konstantinos	GRE	1	1		
MFR FS57Kg	66	Preliminary	Red	6	DAMOUR Valentin	FRA	11	4	VSU	
			Blue	8	VLANDOS Nikolaos	GRE	0	0		
MFR FS97Kg	67	Preliminary	Red	6	SAADAOUI Mohamed	TUN	5	3	VPO1	
			Blue	9	FARDJ Mohamed	ALG	3	1		
MGR GR60K	68	Repechage Round 1	Red	11	FAJARI Fouad	MAR	1	1	VSU1	
			Blue	8	MARVICE Ruben	ITA	9	4		



27 JUN 2022

Start time 10:00

Session 3

### Session Results

MAT C										
Event Short Name	Match No.	Round	Colour	Draw No.	Name	Ctry Code	Tech. Pts.	Class. Pts.	Res. Code	Officials
MFR FS57Kg	69	Preliminary	Red	5	METREVELI VARTANOV Levan	ESP	2	1	VPO1	
			Blue	7	KARAVUS Muhammed	TUR	7	3		
MFR FS97Kg	70	Preliminary	Red	2	IANNATTONI Simone	ITA	0	0	VSU	
			Blue	8	AKTURK Feyzullah	TUR	10	4		
MFR FS86Kg	71	1/8 Final	Red	9	BADAWI Mahmoud	EGY	6	3	VPO	
			Blue	11	ALASTA Mhd Feda Aldin	SYR	0	0		
MFR FS74Kg	72	Quarter-finals	Red	2	HUSSEN Amr	EGY	10	3	VPO	
			Blue	3	AMINE Malik Michael	SMR	0	0		
MFR FS74Kg	73	Quarter-finals	Red	12	DUDAEV Islam	ALB	3	1	VPO1	
			Blue	13	AK Samet	TUR	6	3		
MFR FS57Kg	74	Preliminary	Red	10	KATEB Salah Eddine	ALG	3	1	VPO1	
			Blue	5	METREVELI VARTANOV Levan	ESP	3	3		
MFR FS97Kg	75	Preliminary	Red	10	ELDERS Mostafa	EGY	4	3	VPO	
			Blue	2	IANNATTONI Simone	ITA	0	0		
MFR FS65Kg	76	Quarter-finals	Red	5	EGOROV Vladimir	MKD	5	1	VPO1	
			Blue	6	HAFEZ Yehia	EGY	5	3		
MFR FS86Kg	77	Quarter-finals	Red	3	CHARALAMBOS Choiras	CYP	0	0	VSU	
			Blue	4	ERDIN Fatih	TUR	10	4		
MFR FS125K	78	Quarter-finals	Red	3	ERCAN Salim	TUR	10	4	VSU	
			Blue	4	SHALA Egzon	KOS	0	0		
MFR FS125K	79	Quarter-finals	Red	10	HEMIDA Youssif	EGY	11	4	VSU	
			Blue	11	KAOSLIDIS Alexios	CYP	0	0		
MFR FS57Kg	80	Preliminary	Red	7	KARAVUS Muhammed	TUR	6	5	DSQ	
			Blue	10	KATEB Salah Eddine	ALG	0	0		
MFR FS97Kg	81	Preliminary	Red	8	AKTURK Feyzullah	TUR	7	3	VPO	
			Blue	10	ELDERS Mostafa	EGY	0	0		
MGR GR77K	82	Repechage Round 1	Red	4	SANCHEZ SILVA MEJIAS Marcos	ESP	1	1	VPO1	
			Blue	3	RUSSO Ciro	ITA	6	3		



27 JUN 2022

Start time 17:00

Session 4

### Session Results

MAT A										
Event Short Name	Match No.	Round	Colour	Draw No.	Name	Ctry Code	Tech. Pts.	Class. Pts.	Res. Code	Officials
MFR FS57Kg	83	Semi-finals	Red	6	DAMOUR Valentin	FRA	4	0	VFA	
			Blue	5	METREVELI VARTANOV Levan	ESP	8	5		
MFR FS65Kg	84	Semi-finals	Red	2	ABAKAROV Zelimkhan	ALB	9	3	VPO	
			Blue	3	MICIC Stevan	SRB	0	0		
MFR FS74Kg	85	Semi-finals	Red	2	HUSSEN Amr	EGY	4	5	VFA	
			Blue	6	MASOTTI Jacopo	ITA	0	0		
MFR FS86Kg	86	Semi-finals	Red	2	HAJDARI Osman	ALB	0	0	VSU	
			Blue	4	ERDIN Fatih	TUR	10	4		
MFR FS97Kg	87	Semi-finals	Red	1	NUROV Magomedgadji	MKD	6	3	VPO1	
			Blue	10	ELDERS Mostafa	EGY	1	1		
MFR FS125K	88	Semi-finals	Red	3	ERCAN Salim	TUR	2	1	VPO1	
			Blue	6	NURASULOV Magomedgadzhi	SRB	10	3		
MGR GR60K	89	Bronze-medal	Red	3	MAHMOUD Haythem	EGY	3	3	VPO	
			Blue	2	LIZATOVIC Ivan	CRO	0	0		
MGR GR67K	90	Bronze-medal	Red	3	DE MATOS OLIVEIRA Pedro Miguel	POR	1	1	VPO1	
			Blue	4	ABDELRAHMAN Omar	EGY	3	3		
MGR GR77K	91	Bronze-medal	Red	3	RUSSO Ciro	ITA	1	1	VPO1	
			Blue	2	KAMENJASEVIC Antonio	CRO	3	3		
MGR GR87K	92	Bronze-medal	Red	1	BUR Johnny	FRA	0	0	VPO	
			Blue	5	CENGIZ Ali	TUR	4	3		



27 JUN 2022

Start time 17:00

Session 4

### Session Results

MAT B										
Event Short Name	Match No.	Round	Colour	Draw No.	Name	Ctry Code	Tech. Pts.	Class. Pts.	Res. Code	Officials
MFR FS57Kg	93	Semi-finals	Red	13	OBISPADO MORRIS Studd	ITA	0	0	VSU	
			Blue	7	KARAVUS Muhammed	TUR	10	4		
MFR FS65Kg	94	Semi-finals	Red	6	HAFEZ Yehia	EGY	9	3	VPO1	
			Blue	8	KHERBACHE Abdelhak	ALG	5	1		
MFR FS74Kg	95	Semi-finals	Red	9	IKKAL Abdelkader	ALG	2	1	VPO1	
			Blue	13	AK Samet	TUR	7	3		
MFR FS86Kg	96	Semi-finals	Red	8	BENFERDJALLAH Fateh	ALG	0	0	VSU	
			Blue	13	AMINE Myles Nazem	SMR	10	4		
MFR FS97Kg	97	Semi-finals	Red	6	SAADAOUI Mohamed	TUN	2	1	VPO1	
			Blue	8	AKTURK Feyzullah	TUR	10	3		
MFR FS125K	98	Semi-finals	Red	7	CONYEDO RUANO Abraham De Jesu	ITA	6	3	VPO	
			Blue	10	HEMIDA Youssif	EGY	0	0		
MGR GR60K	99	Bronze-medal	Red	8	MARVICE Ruben	ITA	10	5	DSQ	
			Blue	7	ALNAKDALI Ahmad	SYR	8	0		
MGR GR60K	100	Gold-medal Bout	Red	4	KAMAL Kerem	TUR	8	4	VSU	
			Blue	12	TUDEZCA Leo	FRA	0	0		
MGR GR67K	101	Bronze-medal	Red	12	SNJOYAN Gagik	FRA	4	3	VPO1	
			Blue	6	SANFILIPPO Ignazio	ITA	1	1		
MGR GR67K	102	Gold-medal Bout	Red	2	GHAIOU Ishak	ALG	6	1	VPO1	
			Blue	13	FIRAT Murat	TUR	7	3		
MGR GR77K	103	Bronze-medal	Red	13	ABOUELATTA Emad	EGY	3	1	VPO1	
			Blue	6	PREVOLARAKIS Georgios	GRE	3	3		
MGR GR77K	104	Gold-medal Bout	Red	5	OOUAKALI Abd Elkrim	ALG	0	0	VSU	
			Blue	12	NEMES Viktor	SRB	9	4		
MGR GR87K	105	Bronze-medal	Red	10	DICKOV Zarko	SRB	4	1	VPO1	
			Blue	9	HASSAN Noureldin	EGY	6	3		
MGR GR87K	106	Gold-medal Bout	Red	2	SID AZARA Bachir	ALG	5	3	VPO	
			Blue	13	MINGUZZI Mirco	ITA	0	0		
MGR GR130	107	Bronze-medal	Red	4	KOUCHIT Hichem	ALG	0	0	VSU	
			Blue	8	GUENNICHI Amine	TUN	8	4		
MGR GR130	108	Gold-medal Bout	Red	6	YILDIRIM Osman	TUR	5	3	VPO1	
			Blue	9	MOHAMED Abdellatif	EGY	1	1		



28 JUN 2022

Start time 10:00

Session 5

**Session Results**

MAT A										
Event Short Name	Match No.	Round	Colour	Draw No.	Name	Ctry Code	Tech. Pts.	Class. Pts.	Res. Code	Officials
FFR FS50Kg	109	Preliminary	Red	4	MOHAMED Nada	EGY	3	1	VPO1	
			Blue	8	SABATIE Julie	FRA	10	3		
FFR FS57Kg	110	Preliminary	Red		DE VITA Morena	ITA	0	0	DNS	
			Blue	6	BOUSETA Siwar	TUN	0	0		
FFR FS62Kg	111	Preliminary	Red	6	SOUDANI Mastoura	ALG	0	0	VSU	
			Blue	8	AMRI Marwa	TUN	10	4		
FFR FS68Kg	112	Preliminary	Red	1	JLASSI Khadija	TUN	4	1	VPO1	
			Blue	8	PAMPIN BLANCO Nerea	ESP	7	3		
FFR FS53Kg	113	Quarter-finals	Red	4	RUEDA FLORES Marina	ESP	6	5	VFA	
			Blue	6	HASSOUNE Zineb	MAR	2	0		
FFR FS76Kg	114	Quarter-finals	Red	3	DACHER Kendra	FRA	8	3	VPO1	
			Blue	5	SGHAIER Zaineb	TUN	7	1		
FFR FS76Kg	115	Quarter-finals	Red	11	LERA CELDA Carla	ESP	11	4	VSU	
			Blue	12	BOUGHEZAL Hadil	ALG	1	0		
FFR FS50Kg	116	Preliminary	Red	10	HAMDI Sarra	TUN	3	5	VFA	
			Blue	4	MOHAMED Nada	EGY	1	0		
FFR FS57Kg	117	Preliminary	Red	11	SANCHEZ DIAZ Graciela	ESP	0	0	DNS	
			Blue		DE VITA Morena	ITA	0	0		
FFR FS62Kg	118	Preliminary	Red	11	ESPOSITO Elena	ITA	0	0	VFA	
			Blue	6	SOUDANI Mastoura	ALG	2	5		
MFR FS86Kg	120	Repechage Round 1	Red	12	AIBUEV Akhmed	FRA	11	4	VSU	
			Blue	9	BADAWI Mahmoud	EGY	0	0		
FFR FS50Kg	121	Preliminary	Red	8	SABATIE Julie	FRA	4	3	VPO1	
			Blue	10	HAMDI Sarra	TUN	2	1		
FFR FS57Kg	122	Preliminary	Red	6	BOUSETA Siwar	TUN	4	5	VFA	
			Blue	11	SANCHEZ DIAZ Graciela	ESP	0	0		
FFR FS62Kg	123	Preliminary	Red	8	AMRI Marwa	TUN	2	5	VFA	
			Blue	11	ESPOSITO Elena	ITA	0	0		
FFR FS68Kg	124	Preliminary	Red	8	PAMPIN BLANCO Nerea	ESP	0	0	VSU	
			Blue	12	CANEVA Dalma	ITA	11	4		



28 JUN 2022

Start time 10:00

Session 5

### Session Results

MAT B										
Event Short Name	Match No.	Round	Colour	Draw No.	Name	Ctry Code	Tech. Pts.	Class. Pts.	Res. Code	Officials
FFR FS50Kg	125	Preliminary	Red	2	DOUDOU Ibtissem	ALG	0	0	VPO	
			Blue	6	YAVUZ Evin Demirhan	TUR	6	3		
FFR FS57Kg	126	Preliminary	Red	1	HOUFAF Rayane	ALG	0	0	VFA	
			Blue	5	SALAH DEBIEN Tatiana	FRA	7	5		
FFR FS62Kg	127	Preliminary	Red	4	DOUARRE Ameline	FRA	3	3	VPO1	
			Blue	7	PEREZ TOURINO Lydia	ESP	3	1		
FFR FS68Kg	128	Preliminary	Red	5	LECARPENTIER Pauline	FRA	6	1	VPO1	
			Blue	9	TOSUN CAVUSOGLU Buse	TUR	7	3		
FFR FS53Kg	129	Quarter-finals	Red	8	MOHAMED Shaimaa	EGY	10	3	VPO1	
			Blue	9	CHEMLAL Lamia	ALG	10	1		
FFR FS76Kg	130	Quarter-finals	Red	6	ZACHEILA Stefania	GRE	0	0	VFA	
			Blue	7	RINALDI Enrica	ITA	4	5		
FFR FS50Kg	131	Preliminary	Red	2	DOUDOU Ibtissem	ALG	2	1	VPO1	
			Blue	9	GORRIA GONI Aintzane	ESP	8	3		
FFR FS57Kg	132	Preliminary	Red	1	HOUFAF Rayane	ALG	0	0	VFA	
			Blue	8	GUN Bediha	TUR	3	5		
FFR FS62Kg	133	Preliminary	Red	4	DOUARRE Ameline	FRA	8	3	VPO1	
			Blue	9	TUGCU Asli	TUR	1	1		
FFR FS68Kg	134	Preliminary	Red	12	CANEVA Dalma	ITA	6	1	VPO1	
			Blue	1	JLASSI Khadija	TUN	7	3		
FFR FS50Kg	137	Preliminary	Red	12	LIUZZI Emanuela	ITA	3	3	VPO1	
			Blue	2	DOUDOU Ibtissem	ALG	3	1		
FFR FS57Kg	138	Preliminary	Red	12	HUSSEIN Farah	EGY	0	0	VFA	
			Blue	1	HOUFAF Rayane	ALG	2	5		
FFR FS62Kg	139	Preliminary	Red	12	FABIAN Ana	SRB	1	1	VPO1	
			Blue	4	DOUARRE Ameline	FRA	4	3		
FFR FS68Kg	140	Preliminary	Red	9	TOSUN CAVUSOGLU Buse	TUR	10	4	VSU	
			Blue	13	MERZOUK Thelleli	ALG	0	0		





28 JUN 2022

Start time 10:00

Session 5

**Session Results**

MAT C										
Event Short Name	Match No.	Round	Colour	Draw No.	Name	Ctry Code	Tech. Pts.	Class. Pts.	Res. Code	Officials
FFR FS50Kg	141	Preliminary	Red	9	GORRIA GONI Aintzane	ESP	4	0	VFA	
			Blue	12	LIUZZI Emanuela	ITA	13	5		
FFR FS57Kg	142	Preliminary	Red	8	GUN Bediha	TUR	10	4	VSU	
			Blue	12	HUSSEIN Farah	EGY	0	0		
FFR FS62Kg	143	Preliminary	Red	9	TUGCU Asli	TUR	11	4	VSU	
			Blue	12	FABIAN Ana	SRB	0	0		
FFR FS53Kg	144	Quarter-finals	Red	2	LUTTENAUER Emma	FRA	2	1	VSU1	
			Blue	3	PREVOLARAKI Maria	GRE	12	4		
FFR FS53Kg	145	Quarter-finals	Red	11	DI DIO Carmen	ITA	0	0	VSU	
			Blue	12	YETGIL Zeynep	TUR	10	4		
FFR FS76Kg	146	Quarter-finals	Red	8	HAMZA Samar	EGY	0	0	VSU	
			Blue	9	ADAR YIGIT Yasemin	TUR	10	4		
FFR FS50Kg	147	Preliminary	Red	6	YAVUZ Evin Demirhan	TUR	8	5	VFA	
			Blue	12	LIUZZI Emanuela	ITA	1	0		
FFR FS57Kg	148	Preliminary	Red	5	SALAH DEBIEN Tatiana	FRA	4	3	VPO1	
			Blue	12	HUSSEIN Farah	EGY	2	1		
FFR FS62Kg	149	Preliminary	Red	7	PEREZ TOURINO Lydia	ESP	2	5	VFA	
			Blue	12	FABIAN Ana	SRB	0	0		
FFR FS68Kg	150	Preliminary	Red	13	MERZOUK Thelleli	ALG	0	0	VFA	
			Blue	5	LECARPENTIER Pauline	FRA	12	5		
FFR FS50Kg	153	Preliminary	Red	6	YAVUZ Evin Demirhan	TUR	8	5	VFA	
			Blue	9	GORRIA GONI Aintzane	ESP	0	0		
FFR FS57Kg	154	Preliminary	Red	5	SALAH DEBIEN Tatiana	FRA	0	0	VFA	
			Blue	8	GUN Bediha	TUR	4	5		
FFR FS62Kg	155	Preliminary	Red	7	PEREZ TOURINO Lydia	ESP	6	3	VPO	
			Blue	9	TUGCU Asli	TUR	0	0		



28 JUN 2022

**Session Results**

Start time 17:00

Session 6

MAT A										
Event Short Name	Match No.	Round	Colour	Draw No.	Name	Ctry Code	Tech. Pts.	Class. Pts.	Res. Code	Officials
FFR FS50Kg	156	Semi-finals	Red	6	YAVUZ Evin Demirhan	TUR	6	3	VPO1	
			Blue	10	HAMDY Sarra	TUN	5	1		
FFR FS53Kg	157	Semi-finals	Red	3	PREVOLARAKI Maria	GRE	10	4	VSU	
			Blue	4	RUEDA FLORES Marina	ESP	0	0		
FFR FS57Kg	158	Semi-finals	Red	8	GUN Bediha	TUR	6	5	VFA	
			Blue	11	SANCHEZ DIAZ Graciela	ESP	0	0		
FFR FS62Kg	159	Semi-finals	Red	4	DOUARRE Ameline	FRA	9	3	VPO1	
			Blue	6	SOUDANI Mastoura	ALG	3	1		
FFR FS68Kg	160	Semi-finals	Red	12	CANEVA Dalma	ITA	1	1	VPO1	
			Blue	5	LECARPENTIER Pauline	FRA	2	3		
FFR FS76Kg	161	Semi-finals	Red	3	DACHER Kendra	FRA	0	0	VPO	
			Blue	7	RINALDI Enrica	ITA	6	3		
MFR FS65Kg	162	Bronze-medal	Red	1	AKTAS Munir Recep	TUR	0	0	VPO	
			Blue	3	MICIC Stevan	SRB	4	3		
MFR FS74Kg	163	Bronze-medal	Red	3	AMINE Malik Michael	SMR	6	3	VPO1	
			Blue	6	MASOTTI Jacopo	ITA	4	1		
MFR FS86Kg	164	Bronze-medal	Red	3	CHARALAMBOS Choiras	CYP	6	3	VPO	
			Blue	2	HAJDARI Osman	ALB	1	0		
MFR FS125K	165	Bronze-medal	Red	5	KHELIL Mohamed Billal	ALG	0	0	VSU	
			Blue	3	ERCAN Salim	TUR	10	4		



28 JUN 2022

Start time 17:00

Session 6

### Session Results

MAT B										
Event Short Name	Match No.	Round	Colour	Draw No.	Name	Ctry Code	Tech. Pts.	Class. Pts.	Res. Code	Officials
FFR FS50Kg	166	Semi-finals	Red	12	LIUZZI Emanuela	ITA	1	1	VSU1	
			Blue	8	SABATIE Julie	FRA	11	4		
FFR FS53Kg	167	Semi-finals	Red	8	MOHAMED Shaimaa	EGY	1	1	VPO1	
			Blue	12	YETGIL Zeynep	TUR	4	3		
FFR FS57Kg	168	Semi-finals	Red	5	SALAH DEBIEN Tatiana	FRA	3	1	VPO1	
			Blue	6	BOUSETA Siwar	TUN	4	3		
FFR FS62Kg	169	Semi-finals	Red	7	PEREZ TOURINO Lydia	ESP	0	0	VSU	
			Blue	8	AMRI Marwa	TUN	11	4		
FFR FS68Kg	170	Semi-finals	Red	1	JLASSI Khadija	TUN	0	0	VFA	
			Blue	9	TOSUN CAVUSOGLU Buse	TUR	9	5		
FFR FS76Kg	171	Semi-finals	Red	9	ADAR YIGIT Yasemin	TUR	10	4	VSU	
			Blue	11	LERA CELDA Carla	ESP	0	0		
MFR FS57Kg	172	Bronze-medal	Red	6	DAMOUR Valentin	FRA	2	1	VPO1	
			Blue	13	OBISPADO MORRIS Studd	ITA	10	3		
MFR FS57Kg	173	Gold-medal Bout	Red	5	METREVELI VARTANOV Levan	ESP	2	1	VPO1	
			Blue	7	KARAVUS Muhammed	TUR	9	3		
MFR FS65Kg	174	Bronze-medal	Red	5	EGOROV Vladimir	MKD	7	3	VPO1	
			Blue	8	KHERBACHE Abdelhak	ALG	2	1		
MFR FS65Kg	175	Gold-medal Bout	Red	2	ABAKAROV Zelimkhan	ALB	11	4	VSU	
			Blue	6	HAFEZ Yehia	EGY	0	0		
MFR FS74Kg	176	Bronze-medal	Red	12	DUDAEV Islam	ALB	8	3	VPO	
			Blue	9	IKKAL Abdelkader	ALG	0	0		
MFR FS74Kg	177	Gold-medal Bout	Red	2	HUSSEN Amr	EGY	11	4	VSU1	
			Blue	13	AK Samet	TUR	1	1		
MFR FS86Kg	178	Bronze-medal	Red	12	AIBUEV Akhmed	FRA	10	3	VPO1	
			Blue	8	BENFERDJALLAH Fateh	ALG	1	1		
MFR FS86Kg	179	Gold-medal Bout	Red	4	ERDIN Fatih	TUR	1	1	VPO1	
			Blue	13	AMINE Myles Nazem	SMR	4	3		
MFR FS97Kg	180	Bronze-medal	Red	10	ELDERS Mostafa	EGY	8	1	VPO1	
			Blue	6	SAADAOUI Mohamed	TUN	12	3		
MFR FS97Kg	181	Gold-medal Bout	Red	1	NUROV Magomedgadji	MKD	4	3	VPO1	
			Blue	8	AKTURK Feyzullah	TUR	3	1		
MFR FS125K	182	Bronze-medal	Red	9	ALEXANDRIDIS Konstantinos	GRE	0	0	VSU	
			Blue	10	HEMIDA Youssif	EGY	12	4		
MFR FS125K	183	Gold-medal Bout	Red	6	NURASULOV Magomedgadzhi	SRB	8	3	VPO1	
			Blue	7	CONYEDO RUANO Abraham De Jesu	ITA	1	1		



29 JUN 2022

## Session Results

Start time 18:00

Session 7

MAT A										
Event Short Name	Match No.	Round	Colour	Draw No.	Name	Ctry Code	Tech. Pts.	Class. Pts.	Res. Code	Officials
FFR FS53Kg	184	Bronze-medal	Red	2	LUTTENAUER Emma	FRA	10	1	VPO1	
			Blue	4	RUEDA FLORES Marina	ESP	11	3		
FFR FS76Kg	185	Bronze-medal	Red	6	ZACHEILA Stefania	GRE	0	0	VFA	
			Blue	3	DACHER Kendra	FRA	4	5		



29 JUN 2022

Session Results

Start time 18:00

Session 7

MAT B										
Event Short Name	Match No.	Round	Colour	Draw No.	Name	Ctry Code	Tech. Pts.	Class. Pts.	Res. Code	Officials
FFR FS50Kg	186	Bronze-medal	Red	10	HAMDI Sarra	TUN	4	3	VPO1	
			Blue	12	LIUZZI Emanuela	ITA	2	1		
FFR FS50Kg	187	Gold-medal Bout	Red	6	YAVUZ Evin Demirhan	TUR	3	3	VPO1	
			Blue	8	SABATIE Julie	FRA	2	1		
FFR FS53Kg	188	Bronze-medal	Red	11	DI DIO Carmen	ITA	3	1	VPO1	
			Blue	8	MOHAMED Shaimaa	EGY	6	3		
FFR FS53Kg	189	Gold-medal Bout	Red	3	PREVOLARAKI Maria	GRE	3	3	VPO1	
			Blue	12	YETGIL Zeynep	TUR	1	1		
FFR FS57Kg	190	Bronze-medal	Red	11	SANCHEZ DIAZ Graciela	ESP	3	1	VPO1	
			Blue	5	SALAH DEBIEN Tatiana	FRA	4	3		
FFR FS57Kg	191	Gold-medal Bout	Red	8	GUN Bediha	TUR	5	5	VFA	
			Blue	6	BOUSETA Siwar	TUN	0	0		
FFR FS62Kg	192	Bronze-medal	Red	6	SOUDANI Mastoura	ALG	11	1	VPO1	
			Blue	7	PEREZ TOURINO Lydia	ESP	13	3		
FFR FS62Kg	193	Gold-medal Bout	Red	4	DOUARRE Ameline	FRA	2	1	VPO1	
			Blue	8	AMRI Marwa	TUN	9	3		
FFR FS68Kg	194	Bronze-medal	Red	12	CANEVA Dalma	ITA	5	5	VFA	
			Blue	1	JLASSI Khadija	TUN	0	0		
FFR FS68Kg	195	Gold-medal Bout	Red	5	LECARPENTIER Pauline	FRA	4	3	VPO1	
			Blue	9	TOSUN CAVUSOGLU Buse	TUR	3	1		
FFR FS76Kg	196	Bronze-medal	Red	8	HAMZA Samar	EGY	2	5	VFA	
			Blue	11	LERA CELDA Carla	ESP	0	0		
FFR FS76Kg	197	Gold-medal Bout	Red	7	RINALDI Enrica	ITA	0	0	VSU	
			Blue	9	ADAR YIGIT Yasemin	TUR	10	4		

LEGEND			
<b>Clas.P</b> Classification Points	<b>J</b> Judge	<b>M</b> Mat chairman	<b>MFR</b> Men's Freestyle
<b>MGR</b> Men's Greco-Roman	<b>No</b> Number	<b>PO</b> Decision by Points - the loser without	<b>PP</b> Decision by Points - the loser with tec
<b>R</b> Referee	<b>Res</b> Results	<b>Tech.</b> Technical Points	<b>VT</b> Victory by Fall
<b>WFR</b> Women's Freestyle			
-	-		
-	-		
-	-		



## Entry List by Event

As of SAT 25 JUN 2022

Ctry	Name	Date of Birth
ALB - Albania	SINA Bajram	10 JUL 1998
ALG - Algeria	DJEBBARI Abdeldjbar	3 DEC 1998
CRO - Croatia	LIZATOVIC Ivan	22 NOV 1988
EGY - Egypt	MAHMOUD Haythem	23 SEP 1991
ESP - Spain	BOBILLO VIGIL Daniel	16 NOV 1992
FRA - France	TUDEZCA Léo	21 DEC 1993
ITA - Italy	MARVICE Ruben	23 APR 1995
MAR - Morocco	FAJARI Fouad	18 APR 1989
SYR - Syrian Arab Republic	ALNAKDALI Ahmad	1 JAN 2001
TUR - Turkey	KAMAL Kerem	10 AUG 1999

Total: 10 wrestlers



## Competition Sheet

As of MON 27 JUN 2022 at 19:24

1/8 Final		Quarter-finals		Semi-finals		Gold-medal Bout	
1	DJEBBARI A. ALG	1	DJEBBARI A. ALG $\frac{0}{0}$	2	LIZATOVIC I. CRO $\frac{1}{1}$	4	KAMAL K. TUR $\frac{4}{8}$ VSU
	BYE						
2	LIZATOVIC I. CRO	2	LIZATOVIC I. CRO $\frac{4}{9}$ VSU	4	KAMAL K. TUR $\frac{4}{9}$ VSU1		
	BYE						
3	MAHMOUD H. EGY	3	MAHMOUD H. EGY $\frac{1}{6}$	6	ALNAKDALI A. SYR $\frac{0}{7}$		
	BYE						
4	KAMAL K. TUR	4	KAMAL K. TUR $\frac{3}{7}$ VPO1	10	TUDEZCA L. FRA $\frac{5}{12}$ VFA		
	BYE						
5	SINA B. ALB	5	SINA B. ALB $\frac{0}{0}$	10	TUDEZCA L. FRA $\frac{0}{0}$		
	BYE						
6	ALNAKDALI A. SYR	6	ALNAKDALI A. SYR $\frac{4}{9}$ VSU				
	BYE						
7	MARVICE R. ITA $\frac{3}{6}$ VPO1	7	MARVICE R. ITA $\frac{1}{3}$				
8	BOBILLO VIGIL D. ESP $\frac{1}{2}$	10	TUDEZCA L. FRA $\frac{3}{5}$ VPO1				
9	FAJARI F. MAR $\frac{1}{3}$						
10	TUDEZCA L. FRA $\frac{3}{4}$ VPO1						

Repechage Round 1		Bronze-medal	
	BYE	3	MAHMOUD H. EGY $\frac{3}{3}$ VPO
3	MAHMOUD H. EGY	2	LIZATOVIC I. CRO $\frac{0}{0}$
9	FAJARI F. MAR $\frac{1}{1}$	7	MARVICE R. ITA $\frac{5}{10}$ DSQ
7	MARVICE R. ITA $\frac{4}{9}$ VSU1	6	ALNAKDALI A. SYR $\frac{0}{8}$
		3	MAHMOUD H. EGY
		7	MARVICE R. ITA

Draw number		Classification points	
1	LASTNAME Firstname NOC	$\frac{3}{5}$	VPO1
Technical points		Victory type	
Victory types			
VFA	Victory by fall	VPO	Victory by points
VIN	Victory by injury	VPO1	Victory by points - loser has points
VCA	Victory by 3 cautions	VFO	Victory by forfeit
VSU	Technical superiority	DSQ	Disqualification
VSU1	Great superiority	ZDSQ	Double Disqualification

Classification	
1	KAMAL Kerem TUR
2	TUDEZCA Leo FRA
3	MAHMOUD Havthem EGY
3	MARVICE Ruben ITA
5	LIZATOVIC Ivan CRO
6	FAJARI Fouad MAR
7	BOBILLO VIGIL Daniel ESP
8	DJEBBARI Abdeldibar ALG
9	SINA Bajram ALB



Salle EMEC Palais expositions

Wrestling

Men's Greco-Roman 60kg



## Final Classification

As of MON 27 JUN 2022 at 19:25

Rank	Name	Country Cod
Gold	KAMAL Kerem	TUR
Silver	TUDEZCA Leo	FRA
Bronze	MAHMOUD Haythem	EGY
Bronze	MARVICE Ruben	ITA
5	LIZATOVIC Ivan	CRO
6	FAJARI Fouad	MAR
7	BOBILLO VIGIL Daniel	ESP
8	DJEBBARI Abdeldjbar	ALG
9	SINA Bairam	ALB
EV	ALNAKDALI Ahmad	SYR





## Entry List by Event

As of SAT 25 JUN 2022

Ctry	Name	Date of Birth
ALB - Albania	PRENGA Gjete	22 NOV 1997
ALG - Algeria	GHAIOU Ishak	24 JAN 1995
EGY - Egypt	ABDELRAHMAN Omar	29 APR 2003
FRA - France	SNJOYAN Gagik	4 NOV 2001
ITA - Italy	SANFILIPPO Ignazio	5 FEB 1999
POR - Portugal	DE MATOS OLIVEIRA Pedro Miguel	12 MAR 1997
SYR - Syrian Arab Republic	FAWAZ Mohamad	2 OCT 2000
TUR - Turkey	FIRAT Murat	23 SEP 1997

Total: 8 wrestlers



## Competition Sheet

As of MON 27 JUN 2022 at 19:52

Quarter-finals

Semi-finals

Gold-medal Bout

1 GHAIYOU I. ALG  $\frac{3}{7}$  VPO1

2 DE MATOS POR  $\frac{1}{1}$

3 ABDELRAHMAN O. EGY  $\frac{4}{9}$  VSU

4 PRENGA G. ALB  $\frac{0}{0}$

5 SANFILIPPO I. ITA  $\frac{4}{8}$  VSU

6 FAWAZ M. SYR  $\frac{0}{0}$

7 SNJOYAN G. FRA  $\frac{1}{3}$

8 FIRAT M. TUR  $\frac{3}{6}$  VPO1

1 GHAIYOU I. ALG  $\frac{3}{3}$  VPO1

3 ABDELRAHMAN O. EGY  $\frac{1}{1}$

5 SANFILIPPO I. ITA  $\frac{1}{1}$

8 FIRAT M. TUR  $\frac{3}{6}$  VPO1

1 GHAIYOU I. ALG  $\frac{1}{6}$

8 FIRAT M. TUR  $\frac{3}{7}$  VPO1

Draw number	Classification points	
1	LASTNAME Firstname NOC	$\frac{3}{5}$ VPO1
Technical points		Victory type
Victory types		
VFA	Victory by fall	VPO
VIN	Victory by injury	VPO1
VCA	Victory by 3 cautions	VFO
VSU	Technical superiority	DSQ
VSU1	Great superiority	ZDSQ
		Victory by points
		Victory by points - loser has points
		Victory by forfeit
		Disqualification
		Double Disqualification

GOLD

13 FIRAT M. TUR

SILVER

2 GHAIYOU I. ALG

Classification	
1	FIRAT Murat TU
2	GHAIYOU Ishak AL
3	ABDELRAHMAN Omar EG
3	SNJOYAN Gagik FR
5	DE MATOS OLIVEIRA Pe PO
5	SANFILIPPO Ignazio ITA
7	FAWAZ Mohamad SY
8	PRENGA Gjete AL

### Bronze-medal

2 DE MATOS POR  $\frac{1}{1}$

3 ABDELRAHMAN O. EGY  $\frac{3}{3}$  VPO1

3 ABDELRAHMAN O. EGY

7 SNJOYAN G. FRA  $\frac{3}{4}$  VPO1

5 SANFILIPPO I. ITA  $\frac{1}{1}$

7 SNJOYAN G. FRA



Salle EMEC Palais expositions

Wrestling

Men's Greco-Roman 67kg



## Final Classification

As of MON 27 JUN 2022 at 19:52

Rank	Name	Country Cod
Gold	FIRAT Murat	TUR
Silver	GHAIOU Ishak	ALG
Bronze	ABDELRAHMAN Omar	EGY
Bronze	SNJOYAN Gagik	FRA
5	DE MATOS OLIVEIRA Pedro Miquel	POR
5	SANFILIPPO Ignazio	ITA
7	FAWAZ Mohamad	SYR
8	PRENGA Gjete	ALB



## Entry List by Event

As of SAT 25 JUN 2022

Ctry	Name	Date of Birth
ALB - Albania	KUPI Kevin	28 DEC 1999
ALG - Algeria	OUAKALI Abd Elkrim	19 MAR 1993
CRO - Croatia	KAMENJASEVIC Antonio	29 JAN 1997
EGY - Egypt	ABOUELATTA Emad	1 NOV 2001
ESP - Spain	SANCHEZ SILVA MEJIAS Marcos	19 OCT 1999
FRA - France	GHANEM Ibrahim	17 APR 1995
GRE - Greece	PREVOLARAKIS Georgios	15 OCT 1990
ITA - Italy	RUSSO Ciro	14 OCT 1991
SLO - Slovenia	GUMILAR Luka	11 AUG 2001
SRB - Serbia	NEMES Viktor	21 JUL 1993
SYR - Syrian Arab Republic	ALOBID Mohamad	22 MAR 2003
TUN - Tunisia	MAAFI Lamjed	19 MAR 2001
TUR - Turkey	YILMAZ Ahmet	2 FEB 1996

Total: 13 wrestlers



## Competition Sheet

As of MON 27 JUN 2022 at 20:32

1/8 Final		Quarter-finals		Semi-finals		Gold-medal Bout	
1	ALOBEID M. SYR	1	ALOBEID M. SYR 0/0	2	KAMENJASEVIC A. CRO 0/3	5	OUAKALI A. ALG 0/0
	BYE						
2	KAMENJASEVIC A. CRO	2	KAMENJASEVIC A. CRO 4/9 VSU	5	OUAKALI A. ALG 4/12 VSU		
	BYE						
3	RUSSO C. ITA	3	RUSSO C. ITA 0/0				
	BYE						
4	SANCHEZ SILVA ESP 1/2	5	OUAKALI A. ALG 5/8 VFA				
5	OUAKALI A. ALG 4/10 VSU1						
6	PREVOLARAKIS G. GRE 3/3 VPO1	6	PREVOLARAKIS G. GRE 4/14 VSU1	6	PREVOLARAKIS G. GRE 0/0		
7	YILMAZ A. TUR 1/3						
8	MAAFI L. TUN 3/5 VPO1	8	MAAFI L. TUN 1/4				
9	GHANEM I. FRA 1/3						
10	KUPI K. ALB 4/10 VSU	10	KUPI K. ALB 1/1	12	NEMES V. SRB 4/9 VSU		
11	GUMILAR L. SLO 0/0						
12	NEMES V. SRB 4/9 VSU	12	NEMES V. SRB 4/10 VSU1				
13	ABOUELATTA E. EGY 0/0						

Repechage Round 1		Bronze-medal	
4	SANCHEZ SILVA ESP 1/1	3	RUSSO C. ITA 1/1
3	RUSSO C. ITA 3/6 VPO1	2	KAMENJASEVIC A. CRO
		2	KAMENJASEVIC A. CRO 3/3 VPO1
13	ABOUELATTA E. EGY 4/9 VSU	13	ABOUELATTA E. EGY 1/3
10	KUPI K. ALB 0/0	6	PREVOLARAKIS G. GRE
		6	PREVOLARAKIS G. GRE 3/3 VPO1

Draw number		Classification points	
1	LASTNAME Firstname NOC	3	VPO1
Technical points		Victory type	
Victory types			
VFA	Victory by fall	VPO	Victory by points
VIN	Victory by injury	VPO1	Victory by points - loser has points
VCA	Victory by 3 cautions	VFO	Victory by forfeit
VSU	Technical superiority	DSQ	Disqualification
VSU1	Great superiority	2DSQ	Double Disqualification

Classification	
1	NEMES Viktor SRB
2	OUAKALI Abd Elkrim ALG
3	KAMENJASEVIC Antonio CRO
3	PREVOLARAKIS Georgios GRE
5	RUSSO Ciro ITA
5	ABOUELATTA Emad EGY
7	KUPI Kevin ALB
8	MAAFI Lamied TUN
9	SANCHEZ SILVA MEJIAS Marcos ESP
10	YILMAZ Ahmet TUR
11	GHANEM Ibrahim FRA
12	ALOBEID Mohamad SYR
13	GUMILAR Luka SLO



Salle EMEC Palais expositions

Wrestling

Men's Greco-Roman 77kg



## Final Classification

As of MON 27 JUN 2022 at 20:32

Rank	Name	Country Cod
Gold	NEMES Viktor	SRB
Silver	OOUAKALI Abd Elkrim	ALG
Bronze	KAMENJASEVIC Antonio	CRO
Bronze	PREVOLARAKIS Georgios	GRE
5	RUSSO Ciro	ITA
5	ABOUELATTA Emad	EGY
7	KUPI Kevin	ALB
8	MAAFI Lamjed	TUN
9	SANCHEZ SILVA MEJIAS Marcos	ESP
10	YILMAZ Ahmet	TUR
11	GHANEM Ibrahim	FRA
12	ALBEID Mohamad	SYR
13	GUMILAR Luka	SLO



## Entry List by Event

As of SAT 25 JUN 2022

Ctry	Name	Date of Birth
ALG - Algeria	SID AZARA Bachir	3 MAR 1996
CRO - Croatia	LUBURIC Vjekoslav	24 JAN 1996
EGY - Egypt	HASSAN Nouredin	2 MAR 1998
FRA - France	BUR Johnny	5 JUN 1995
ITA - Italy	MINGUZZI Mirco	10 MAY 1998
SRB - Serbia	DICKOV Zarko	1 DEC 1996
TUN - Tunisia	MISSAOUI Mohamed Skander	27 JAN 1989
TUR - Turkey	CENGIZ Ali	8 APR 1996

Total: 8 wrestlers



## Competition Sheet

As of MON 27 JUN 2022 at 21:17

Quarter-finals

Semi-finals

Gold-medal Bout

1 BUR J. FRA 0/0

2 SID AZARA B. ALG 3/4 VPO

2 SID AZARA B. ALG 3/3 VPO

3 LUBURIC V. CRO 1/3

4 CENGIZ A. TUR 0/0

4 CENGIZ A. TUR 3/6 VPO1

5 MISSAOUI M. TUN 0/0

6 HASSAN N. EGY 1/3

6 HASSAN N. EGY 4/9 VSU

7 DICKOV Z. SRB 1/3

8 MINGUZZI M. ITA 3/7 VPO1

8 MINGUZZI M. ITA 3/6 VPO1

2 SID AZARA B. ALG 3/5 VPO

8 MINGUZZI M. ITA 0/0

Draw number	Classification points		
1	LASTNAME Firstname NOC	3/5 VPO1	
Technical points		Victory type	
Victory types			
VFA	Victory by fall	VPO	Victory by points
VIN	Victory by injury	VPO1	Victory by points - loser has points
VCA	Victory by 3 cautions	VFO	Victory by forfeit
VSU	Technical superiority	DSQ	Disqualification
VSU1	Great superiority	ZDSQ	Double Disqualification

GOLD

2 SID AZARA B. ALG

SILVER

13 MINGUZZI M. ITA

Classification		
1	SID AZARA Bachir	AL
2	MINGUZZI Mirco	ITA
3	CENGIZ Ali	TU
3	HASSAN Nouredin	EG
5	BUR Johnnv	FR
5	DICKOV Zarko	SR
7	LUBURIC Vjekoslav	CR
8	MISSAOUI Mohamed S	TU

Bronze-medal

1 BUR J. FRA 0/0

4 CENGIZ A. TUR

4 CENGIZ A. TUR 3/4 VPO

7 DICKOV Z. SRB 1/4

6 HASSAN N. EGY

6 HASSAN N. EGY 3/6 VPO1





Salle EMEC Palais expositions

Wrestling

Men's Greco-Roman 87kg



## Final Classification

As of MON 27 JUN 2022 at 21:17

Rank	Name	Country Cod
Gold	SID AZARA Bachir	ALG
Silver	MINGUZZI Mirco	ITA
Bronze	CENGIZ Ali	TUR
Bronze	HASSAN Noureldin	EGY
5	BUR Johnnv	FRA
5	DICKOV Zarko	SRB
7	LUBURIC Vjekoslav	CRO
8	MISSAOUI Mohamed Skander	TUN



## Entry List by Event

As of SAT 25 JUN 2022

Ctry	Name	Date of Birth
ALG - Algeria	KOUCHIT Hichem	12 DEC 1993
EGY - Egypt	MOHAMED Abdellatif	8 DEC 1995
GRE - Greece	NTOUNIAS Nikolaos	16 OCT 2001
ITA - Italy	VARICELLI Samuele	11 OCT 1997
TUN - Tunisia	GUENNICHI Amine	16 MAR 1999
TUR - Turkey	YILDIRIM Osman	25 MAR 1996

Total: 6 wrestlers



## Competition Sheet Nordic

As of SUN 26 JUN 2022 at 12:35

1	NTOUNIAS N.	GRE	1/1			
3	YILDIRIM O.	TUR	4/9	VSU1	3	YILDIRIM O. TUR
5	MOHAMED A.	EGY	4/8	VSU1		
1	NTOUNIAS N.	GRE	0/0		5	MOHAMED A. EGY
3	YILDIRIM O.	TUR	3/3	VPO1		
5	MOHAMED A.	EGY	1/1		3	YILDIRIM O. TUR

Draw number	Classification points		
1	LASTNAME Firstname NOC	3/5 VPO1	
Technical points		Victory type	
Victory types			
VFA	Victory by fall	VPO	Victory by points
VIN	Victory by injury	VPO1	Victory by points - loser has points
VCA	Victory by 3 cautions	VFO	Victory by forfeit
VSU	Technical superiority	DSQ	Disqualification
VSU!	Great superiority	2DSQ	Double Disqualification

Group A			Matches			
Rank	Ctry	Name	Played	Won	Lost	Points
1	TUR	YILDIRIM Osman	2	2	0	7
2	EGY	MOHAMED Abdellatif	2	1	1	5
3	GRE	NTOUNIAS Nikolaos	2	0	2	1

2	KOUCHIT H.	ALG	0/1			
4	GUENNICHI A.	TUN	5/5	VFA	4	GUENNICHI A. TUN
6	VARICELLI S.	ITA	0/0			
2	KOUCHIT H.	ALG	4/9	VSU	2	KOUCHIT H. ALG
4	GUENNICHI A.	TUN	4/9	VSU		
6	VARICELLI S.	ITA	0/0		4	GUENNICHI A. TUN

Group B			Matches			
Rank	Ctry	Name	Played	Won	Lost	Points
1	TUN	GUENNICHI Amine	2	2	0	9
2	ALG	KOUCHIT Hichem	2	1	1	4
3	ITA	VARICELLI Samuele	2	0	2	0



## Competition Sheet

As of MON 27 JUN 2022 at 21:42

Semi-finals

Gold-medal Bout

3	YILDIRIM O.	TUR	4/8	VSU
---	-------------	-----	-----	-----

3	YILDIRIM O.	TUR	3/5	VPO1
---	-------------	-----	-----	------

2	KOUCHIT H.	ALG	0/0	
---	------------	-----	-----	--

5	MOHAMED A.	EGY	3/2	VPO
---	------------	-----	-----	-----

5	MOHAMED A.	EGY	1/1	
---	------------	-----	-----	--

4	GUENNICH A.	TUN	0/0	
---	-------------	-----	-----	--

Draw number	Classification points		Technical points		Victory type
1	LASTNAME	Firstname	NOC	3/5	VPO1
Victory types					
VFA	Victory by fall		VPO	Victory by points	
VIN	Victory by injury		VPO1	Victory by points - loser has points	
VCA	Victory by 3 cautions		VFO	Victory by forfeit	
VSU	Technical superiority		DSQ	Disqualification	
VSU1	Great superiority		ZDSQ	Double Disqualification	

GOLD

6	YILDIRIM O.	TUR		
---	-------------	-----	--	--

SILVER

9	MOHAMED A.	EGY		
---	------------	-----	--	--

Classification		
1	YILDIRIM Osman	TU
2	MOHAMED Abdellatif	EG
3	GUENNICH Amine	TU
4	KOUCHIT Hichem	AL
5	NTOUNIAS Nikolaos	GR
6	VARICELLI Samuele	ITA

Bronze-medal

2	KOUCHIT H.	ALG	0/0	
---	------------	-----	-----	--

4	GUENNICH A.	TUN	4/8	VSU
---	-------------	-----	-----	-----



Salle EMEC Palais expositions

Wrestling

Men's Greco-Roman 130kg



## Final Classification

As of MON 27 JUN 2022 at 21:42

Rank	Name	Country Cod
Gold	YILDIRIM Osman	TUR
Silver	MOHAMED Abdellatif	EGY
Bronze	GUENNICHI Amine	TUN
4	KOUCHIT Hichem	ALG
5	NTOUNIAS Nikolaos	GRE
6	VARICELLI Samuele	ITA



## Entry List by Event

As of SAT 25 JUN 2022

Ctry	Name	Date of Birth
ALG - Algeria	KATEB Salah Eddine	22 JUN 1998
EGY - Egypt	MOHAMED Gamal	24 FEB 1999
ESP - Spain	METREVELI VARTANOV Levan	5 DEC 1984
FRA - France	DAMOUR Valentin	28 DEC 1999
GRE - Greece	VLANDOS Nikolaos	29 JUN 1999
ITA - Italy	OBISPADO MORRIS Studd	19 SEP 2000
TUR - Turkey	KARAVUS Muhammed	10 JUN 2002

Total: 7 wrestlers



### Competition Sheet Nordic

As of MON 27 JUN 2022 at 12:11

1	MOHAMED G.	EGY	1/1			
3	DAMOUR V.	FRA	4/12	VSU1	3	DAMOUR V. FRA
5	VLANDOS N.	GRE	0/0			
7	OBISPADO MORRIS	ITA	5/6	VFA	7	OBISPADO MORRIS ITA
1	MOHAMED G.	EGY	4/10	VSU	1	MOHAMED G. EGY
5	VLANDOS N.	GRE	0/0			
3	DAMOUR V.	FRA	3/8	VPO1	3	DAMOUR V. FRA
7	OBISPADO MORRIS	ITA	1/2			
7	OBISPADO MORRIS	ITA	3/10	VPO1	7	OBISPADO MORRIS ITA
1	MOHAMED G.	EGY	1/5			
3	DAMOUR V.	FRA	4/11	VSU	3	DAMOUR V. FRA
5	VLANDOS N.	GRE	0/0			

Draw number	Classification points		
1	LASTNAME Firstname NOC	3/5 VPO1	
Technical points		Victory type	
Victory types			
VFA	Victory by fall	VPO	Victory by points
VIN	Victory by injury	VPO1	Victory by points - loser has points
VCA	Victory by 3 cautions	VFO	Victory by forfeit
VSU	Technical superiority	DSQ	Disqualification
VSU1	Great superiority	2DSQ	Double Disqualification

Group A			Matches			
Rank	Ctry	Name	Played	Won	Lost	Points
1	FRA	DAMOUR Valentin	3	3	0	11
2	ITA	OBISPADO MORRIS Studd	3	2	1	9
3	EGY	MOHAMED Gamal	3	1	2	6
4	GRE	VLANDOS Nikolaos	3	0	3	0

2	METREVELI VART.	ESP	1/2			
4	KARAVUS M.	TUR	3/7	VPO1	4	KARAVUS M. TUR
6	KATEB S.	ALG	1/3			
2	METREVELI VART.	ESP	3/3	VPO1	2	METREVELI VART. ESP
4	KARAVUS M.	TUR	5/6	DSQ	4	KARAVUS M. TUR
6	KATEB S.	ALG	0/0			

Group B			Matches			
Rank	Ctry	Name	Played	Won	Lost	Points
1	TUR	KARAVUS Muhammed	2	2	0	8
2	ESP	METREVELI VARTANOV Levan	2	1	1	4
3	ALG	KATEB Salah Eddine	2	0	2	1



## Competition Sheet

As of MON 27 JUN 2022 at 17:52

Semi-finals

Gold-medal Bout

3	DAMOUR V.	FRA	0	4
---	-----------	-----	---	---

2	METREVELI VART.	ESP		
---	-----------------	-----	--	--

2	METREVELI VART.	ESP	5	8	VFA
---	-----------------	-----	---	---	-----

7	OBISPADO MORRIS	ITA	0	0
---	-----------------	-----	---	---

4	KARAVUS M.	TUR		
---	------------	-----	--	--

4	KARAVUS M.	TUR	4	10	VSU
---	------------	-----	---	----	-----

Draw number	Classification points		Technical points		Victory type
1	LASTNAME	Firstname	NOC	3 5	VPO1

Victory types	
VFA	Victory by fall
VIN	Victory by injury
VCA	Victory by 3 cautions
VSU	Technical superiority
VSU1	Great superiority
VPO	Victory by points
VPO1	Victory by points - loser has points
VFO	Victory by forfeit
DSQ	Disqualification
ZDSQ	Double Disqualification

Classification	
5	MOHAMED Gamal EG
6	KATEB Salah Eddine AL
7	VLANDOS Nikolaos GR

Bronze-medal

3	DAMOUR V.	FRA
---	-----------	-----

7	OBISPADO MORRIS	ITA
---	-----------------	-----





Salle EMEC Palais expositions

Wrestling

Men's Freestyle 57kg



## Final Classification

As of TUE 28 JUN 2022 at 19:24

Rank	Name	Country Cod
Gold	KARAVUS Muhammed	TUR
Silver	METREVELI VARTANOV Levan	ESP
Bronze	OBISPADO MORRIS Studd	ITA
4	DAMOUR Valentin	FRA
5	MOHAMED Gamal	EGY
6	KATEB Salah Eddine	ALG
7	VLANDOS Nikolaos	GRE
EV	KATEB Salah Eddine	ALG



## Entry List by Event

As of SAT 25 JUN 2022

Ctry	Name	Date of Birth
ALB - Albania	ABAKAROV Zelimkhan	14 JUL 1993
ALG - Algeria	KHERBACHE Abdelhak	25 JUN 1995
EGY - Egypt	HAFEZ Yehia	27 OCT 2002
ESP - Spain	GONZALEZ CRESPO Juan Pablo	21 JAN 1992
FRA - France	STICKER Quentin	8 DEC 1994
ITA - Italy	REALBUTO Colin John	28 MAY 2000
MKD - Rep. of North Macedonia	EGOROV Vladimir	27 JUN 1995
SRB - Serbia	MICIC Stevan	4 APR 1996
SYR - Syrian Arab Republic	DIRKI Ahmad	6 MAR 2022
TUR - Turkey	AKTAS Munir Recep	26 JUN 1989

Total: 10 wrestlers



## Competition Sheet

As of TUE 28 JUN 2022 at 19:40

1/8 Final		Quarter-finals		Semi-finals		Gold-medal Bout	
1	AKTAS M. TUR	1	AKTAS M. TUR $\frac{1}{4}$	2	ABAKAROV Z. ALB $\frac{3}{9}$ VPO	2	ABAKAROV Z. ALB $\frac{4}{11}$ VSU
	BYE						
2	ABAKAROV Z. ALB	2	ABAKAROV Z. ALB $\frac{3}{8}$ VPO1	3	MICIC S. SRB $\frac{0}{0}$		
	BYE						
3	MICIC S. SRB	3	MICIC S. SRB $\frac{4}{10}$ VSU	6	HAFEZ Y. EGY $\frac{3}{9}$ VPO1		
	BYE						
4	STICKER Q. FRA	4	STICKER Q. FRA $\frac{0}{0}$	8	KHERBACHE A. ALG $\frac{1}{5}$		
	BYE						
5	EGOROV V. MKD	5	EGOROV V. MKD $\frac{1}{5}$	10	DIRKI A. SYR $\frac{1}{5}$		
	BYE						
6	HAFEZ Y. EGY	6	HAFEZ Y. EGY $\frac{3}{5}$ VPO1				
	BYE						
7	GONZALEZ CRESPO ESP $\frac{1}{2}$	8	KHERBACHE A. ALG $\frac{3}{6}$ VPO1				
8	KHERBACHE A. ALG $\frac{3}{2}$ VPO1						
9	REALBUTO C. ITA $\frac{1}{4}$						
10	DIRKI A. SYR $\frac{3}{7}$ VPO1						

Repechage Round 1		Bronze-medal	
	BYE	1	AKTAS M. TUR $\frac{0}{0}$
1	AKTAS M. TUR	3	MICIC S. SRB $\frac{3}{4}$ VPO
	BYE	5	EGOROV V. MKD $\frac{3}{7}$ VPO1
5	EGOROV V. MKD	8	KHERBACHE A. ALG $\frac{1}{2}$

Draw number	Classification points		
1	LASTNAME Firstname NOC	$\frac{3}{5}$ VPO1	
Technical points		Victory type	
Victory types			
VFA	Victory by fall	VPO	Victory by points
VIN	Victory by injury	VPO1	Victory by points - loser has points
VCA	Victory by 3 cautions	VFO	Victory by forfeit
VST	Technical superiority	DSQ	Disqualification
VST1	Great superiority	2DSQ	Double Disqualification

Classification	
1	ABAKAROV Zelimkhan ALB
2	HAFEZ Yehia EGY
3	MICIC Stevan SRB
3	EGOROV Vladimir MKD
5	AKTAS Munir Recep TUR
5	KHERBACHE Abdelhak ALG
7	DIRKI Ahmad SYR
8	REALBUTO Colin John ITA
9	GONZALEZ CRESPO Juan Pablo ESP
10	STICKER Quentin FRA



Salle EMEC Palais expositions

Wrestling

Men's Freestyle 65kg



## Final Classification

As of TUE 28 JUN 2022 at 19:41

Rank	Name	Country Cod
Gold	ABAKAROV Zelimkhan	ALB
Silver	HAFEZ Yehia	EGY
Bronze	MICIC Stevan	SRB
Bronze	EGOROV Vladimir	MKD
5	AKTAS Munir Recep	TUR
5	KHERBACHE Abdelhak	ALG
7	DIRKI Ahmad	SYR
8	REALBUTO Colin John	ITA
9	GONZALEZ CRESPO Juan Pablo	ESP
10	STICKER Quentin	FRA



## Entry List by Event

As of SAT 25 JUN 2022

Ctry	Name	Date of Birth
ALB - Albania	DUDAEV Islam	15 JAN 1995
ALG - Algeria	IKKAL Abdelkader	16 DEC 2000
EGY - Egypt	HUSSEN Amr	26 AUG 1997
ITA - Italy	MASOTTI Jacopo	21 MAY 1998
KOS - Kosovo	SOPA Alban	9 JUL 1989
MKD - Rep. of North Macedonia	VEJSELI Fati	31 JAN 1999
SMR - San Marino	AMINE Malik Michael	4 JUL 1995
TUR - Turkey	AK Samet	6 AUG 1998

Total: 8 wrestlers



## Competition Sheet

As of TUE 28 JUN 2022 at 20:13

Quarter-finals

Semi-finals

Gold-medal Bout

1 HUSSEN A. EGY  $\frac{3}{10}$  VPO

2 AMINE M. SMR  $\frac{0}{0}$

3 MASOTTI J. ITA  $\frac{3}{4}$  VPO

4 SOPA A. KOS  $\frac{0}{0}$

5 IKKAL A. ALG  $\frac{3}{3}$  VPO1

6 VEJSELI F. MKD  $\frac{1}{2}$

7 DUDAEV I. ALB  $\frac{1}{3}$

8 AK S. TUR  $\frac{3}{6}$  VPO1

1 HUSSEN A. EGY  $\frac{5}{4}$  VFA

3 MASOTTI J. ITA  $\frac{0}{0}$

5 IKKAL A. ALG  $\frac{1}{2}$

8 AK S. TUR  $\frac{3}{7}$  VPO1

1 HUSSEN A. EGY  $\frac{4}{11}$  VSU1

8 AK S. TUR  $\frac{1}{1}$

Draw number		Classification points	
1	LASTNAME Firstname NOC	$\frac{3}{5}$	VPO1
		Technical points	Victory type
Victory types			
VFA	Victory by fall	VPO	Victory by points
VIN	Victory by injury	VPO1	Victory by points - loser has points
VCA	Victory by 3 cautions	VFO	Victory by forfeit
VSU	Technical superiority	DSQ	Disqualification
VSU1	Great superiority	ZDSQ	Double Disqualification

GOLD

2 HUSSEN A. EGY

SILVER

13 AK S. TUR

Classification		
1	HUSSEN Amr	EG
2	AK Samet	TU
3	AMINE Malik Michael	SM
3	DUDAEV Islam	AL
5	MASOTTI Jacopo	ITA
5	IKKAL Abdelkader	AL
7	VEJSELI Fati	M
8	SOPA Alban	KO

### Bronze-medal

2 AMINE M. SMR  $\frac{3}{6}$  VPO1

3 MASOTTI J. ITA  $\frac{1}{4}$

7 DUDAEV I. ALB  $\frac{3}{8}$  VPO

5 IKKAL A. ALG  $\frac{0}{0}$

2 AMINE M. SMR

7 DUDAEV I. ALB



Salle EMEC Palais expositions

Wrestling

Men's Freestyle 74kg



## Final Classification

As of TUE 28 JUN 2022 at 20:13

Rank	Name	Country Cod
Gold	HUSSEN Amr	EGY
Silver	AK Samet	TUR
Bronze	AMINE Malik Michael	SMR
Bronze	DUDAEV Islam	ALB
5	MASOTTI Jacopo	ITA
5	IKKAL Abdelkader	ALG
7	VEJSELI Fati	MKD
8	SOPA Alban	KOS



## Entry List by Event

As of SAT 25 JUN 2022

Ctry	Name	Date of Birth
ALB - Albania	HAJDARI Osman	29 MAY 1994
ALG - Algeria	BENFERDJALLAH Fateh	15 APR 2001
CYP - Cyprus	CHARALAMBOS Choiras	25 SEP 2002
EGY - Egypt	BADAWI Mahmoud	6 APR 1998
ESP - Spain	IGLESIAS VILELA Damian	28 JUL 1993
FRA - France	AIBUEV Akhmed	12 FEB 1991
ITA - Italy	CANEVA Aron	30 MAY 1995
SMR - San Marino	AMINE Myles Nazem	14 DEC 1996
SYR - Syrian Arab Republic	ALASTA Mhd Feda Aldin	30 JAN 1999
TUR - Turkey	ERDIN Fatih	1 FEB 1994

Total: 10 wrestlers





## Competition Sheet

As of TUE 28 JUN 2022 at 20:52

1/8 Final		Quarter-finals		Semi-finals		Gold-medal Bout	
1	IGLESIAS VILELA ESP	1	IGLESIAS VILELA ESP $\frac{1}{2}$	2	HAJDARI O. ALB $\frac{0}{0}$	4	ERDIN F. TUR $\frac{1}{1}$
	BYE						
2	HAJDARI O. ALB	2	HAJDARI O. ALB $\frac{3}{3}$ VPO1	4	ERDIN F. TUR $\frac{4}{10}$ VSU		
	BYE						
3	CHARALAMBOS C. CYP	3	CHARALAMBOS C. CYP $\frac{0}{0}$	4	ERDIN F. TUR $\frac{4}{10}$ VSU		
	BYE						
4	ERDIN F. TUR	4	ERDIN F. TUR $\frac{4}{10}$ VSU				
	BYE						
5	CANEVA A. ITA	5	CANEVA A. ITA $\frac{1}{1}$	6	BENFERDJALLAH F ALG $\frac{0}{0}$		
	BYE						
6	BENFERDJALLAH F ALG	6	BENFERDJALLAH F ALG $\frac{3}{5}$ VPO1	10	AMINE M. SMR $\frac{4}{10}$ VSU		
	BYE						
7	BADAWI M. EGY $\frac{3}{6}$ VPO	7	BADAWI M. EGY $\frac{0}{0}$				
8	ALASTA M. SYR $\frac{0}{0}$						
9	AIBUEV A. FRA $\frac{1}{1}$	10	AMINE M. SMR $\frac{4}{10}$ VSU				
10	AMINE M. SMR $\frac{3}{6}$ VPO1						

Repechage Round 1		Bronze-medal	
	BYE	3	CHARALAMBOS C. CYP $\frac{3}{6}$ VPO
3	CHARALAMBOS C. CYP	2	HAJDARI O. ALB $\frac{0}{1}$
		3	CHARALAMBOS C. CYP
9	AIBUEV A. FRA $\frac{4}{11}$ VSU	9	AIBUEV A. FRA $\frac{3}{10}$ VPO1
7	BADAWI M. EGY $\frac{0}{0}$	9	AIBUEV A. FRA
		6	BENFERDJALLAH F ALG $\frac{1}{1}$

Draw number		Classification points	
1	LASTNAME Firstname NOC	$\frac{3}{5}$	VPO1
Technical points		Victory type	
Victory types			
VFA	Victory by fall	VPO	Victory by points
VIN	Victory by injury	VPO1	Victory by points - loser has points
VCA	Victory by 3 cautions	VFO	Victory by forfeit
VSU	Technical superiority	DSQ	Disqualification
VSU1	Great superiority	ZDSQ	Double Disqualification

Classification	
1	AMINE Mvles Nazem SMR
2	ERDIN Fatih TUR
3	CHARALAMBOS Choiras CYP
3	AIBUEV Akhmed FRA
5	HAJDARI Osman ALB
5	BENFERDJALLAH Fateh ALG
7	BADAWI Mahmoud EGY
8	IGLESIAS VILELA Damian ESP
9	CANEVA Aron ITA
10	ALASTA Mhd Feda Aldin SYR



Salle EMEC Palais expositions

Wrestling

Men's Freestyle 86kg



## Final Classification

As of TUE 28 JUN 2022 at 20:52

Rank	Name	Country Cod
Gold	AMINE Myles Nazem	SMR
Silver	ERDIN Fatih	TUR
Bronze	CHARALAMBOS Choiras	CYP
Bronze	AIBUEV Akhmed	FRA
5	HAJDARI Osman	ALB
5	BENFERDJALLAH Fateh	ALG
7	BADAWI Mahmoud	EGY
8	IGLESIAS VILELA Damian	ESP
9	CANEVA Aron	ITA
10	ALASTA Mhd Feda Aldin	SYR



## Entry List by Event

As of SAT 25 JUN 2022

Ctry	Name	Date of Birth
ALG - Algeria	FARDJ Mohamed	19 JUL 1998
EGY - Egypt	ELDERS Mostafa	12 DEC 1998
ESP - Spain	CANADA PANCORBO Alejandro	21 AUG 1996
ITA - Italy	IANNATTONI Simone	23 OCT 1997
MKD - Rep. of North Macedonia	NUROV Magomedgadji	19 APR 1993
TUN - Tunisia	SAADAoui Mohamed	11 MAY 1995
TUR - Turkey	AKTURK Feyzullah	1 JAN 1999

Total: 7 wrestlers



## Competition Sheet Nordic

As of MON 27 JUN 2022 at 12:17

1	NUROV M.	MKD	4 13	VSU1	1	NUROV M.	MKD
3	SAADAOUI M.	TUN	1 2				
5	FARDJ M.	ALG	0 0				
7	CANADA PANCORBO	ESP	3 4	VPO	7	CANADA PANCORBO	ESP
1	NUROV M.	MKD	5 10	VFA	1	NUROV M.	MKD
5	FARDJ M.	ALG	0 0				
3	SAADAOUI M.	TUN	3 6	VPO1	3	SAADAOUI M.	TUN
7	CANADA PANCORBO	ESP	1 2				
7	CANADA PANCORBO	ESP	0 0				
1	NUROV M.	MKD	4 10	VSU	1	NUROV M.	MKD
3	SAADAOUI M.	TUN	3 5	VPO1	3	SAADAOUI M.	TUN
5	FARDJ M.	ALG	1 3				

Draw number	Classification points		
1	LASTNAME Firstname NOC	3 5 VPO1	
Technical points		Victory type	
Victory types			
VFA	Victory by fall	VPO	Victory by points
VIN	Victory by injury	VPO1	Victory by points - loser has points
VCA	Victory by 3 cautions	VFO	Victory by forfeit
VSU	Technical superiority	DSQ	Disqualification
VSU1	Great superiority	2DSQ	Double Disqualification

Group A			Matches			
Rank	Ctry	Name	Played	Won	Lost	Points
1	MKD	NUROV Magomedgadji	3	3	0	13
2	TUN	SAADAOUI Mohamed	3	2	1	7
3	ESP	CANADA PANCORBO Alejandro	3	1	2	4
4	ALG	FARDJ Mohamed	3	0	3	1

2	IANNATTONI S.	ITA	0 0				
4	AKTURK F.	TUR	4 10	VSU	4	AKTURK F.	TUR
6	ELDERS M.	EGY	3 4	VPO	6	ELDERS M.	EGY
2	IANNATTONI S.	ITA	0 0				
4	AKTURK F.	TUR	3 7	VPO	4	AKTURK F.	TUR
6	ELDERS M.	EGY	0 0				

Group B			Matches			
Rank	Ctry	Name	Played	Won	Lost	Points
1	TUR	AKTURK Feyzullah	2	2	0	7
2	EGY	ELDERS Mostafa	2	1	1	3
3	ITA	IANNATTONI Simone	2	0	2	0



## Competition Sheet

As of TUE 28 JUN 2022 at 21:31

Semi-finals

Gold-medal Bout

1	NUROV M.	MKD	3/6	VPO1
---	----------	-----	-----	------

1	NUROV M.	MKD	3/4	VPO1
---	----------	-----	-----	------

6	ELDERS M.	EGY	1/1	
---	-----------	-----	-----	--

3	SAADAOU M.	TUN	1/2	
---	------------	-----	-----	--

4	AKTURK F.	TUR	1/3	
---	-----------	-----	-----	--

4	AKTURK F.	TUR	3/10	VPO1
---	-----------	-----	------	------

Draw number	Classification points		Technical points		Victory type
1	LASTNAME	Firstname	NOC	3/5	VPO1
<b>Victory types</b> VFA Victory by fall    VPO Victory by points VIN Victory by injury    VPO1 Victory by points - loser has points VCA Victory by 3 cautions    VFO Victory by forfeit VSU Technical superiority    DSQ Disqualification VSU1 Great superiority    ZDSQ Double Disqualification					

GOLD

1	NUROV M.	MKD
---	----------	-----

SILVER

8	AKTURK F.	TUR
---	-----------	-----

Classification		
1	NUROV Magomedgadii	M
2	AKTURK Fevzullah	TU
3	SAADAOU Mohamed	TU
4	ELDERS Mostafa	EG
5	CANADA PANCORBO AI	ES
6	FARDJ Mohamed	AL
7	IANNATTONI Simone	ITA

Bronze-medal

6	ELDERS M.	EGY	1/8
---	-----------	-----	-----

3	SAADAOU M.	TUN	3/12	VPO1
---	------------	-----	------	------



Salle EMEC Palais expositions

Wrestling

Men's Freestyle 97kg



## Final Classification

As of TUE 28 JUN 2022 at 21:31

Rank	Name	Country Cod
Gold	NUROV Maqomedqadij	MKD
Silver	AKTURK Feyzullah	TUR
Bronze	SAADAQUI Mohamed	TUN
4	ELDERS Mostafa	EGY
5	CANADA PANCORBO Aleiandro	ESP
6	FARDJ Mohamed	ALG
7	IANNATTONI Simone	ITA



## Entry List by Event

As of SAT 25 JUN 2022

Ctry	Name	Date of Birth
ALG - Algeria	KHELIL Mohamed Billal	30 JUN 1993
CYP - Cyprus	KAOSLIDIS Alexios	1 JAN 1994
EGY - Egypt	HEMIDA Youssif	13 SEP 1997
GRE - Greece	ALEXANDRIDIS Konstantinos	27 APR 2002
ITA - Italy	CONYEDO RUANO Abraham De Jesus	7 OCT 1993
KOS - Kosovo	SHALA Egzon	23 NOV 1990
SRB - Serbia	NURASULOV Magomedgadzhi	15 JUL 1992
SYR - Syrian Arab Republic	SAREM Omar	10 MAR 2001
TUR - Turkey	ERCAN Salim	10 MAR 1996

Total: 9 wrestlers



## Competition Sheet

As of TUE 28 JUN 2022 at 21:58

1/8 Final		Quarter-finals		Semi-finals		Gold-medal Bout	
1	ERCAN S. TUR	1	ERCAN S. TUR $\frac{4}{10}$ VSU	1	ERCAN S. TUR $\frac{1}{2}$	4	NURASULOV M. SRB $\frac{3}{8}$ VPO1
	BYE						
2	SHALA E. KOS	2	SHALA E. KOS $\frac{0}{0}$				
	BYE						
3	KHELIL M. ALG	3	KHELIL M. ALG $\frac{0}{0}$	4	NURASULOV M. SRB $\frac{3}{10}$ VPO1		
	BYE						
4	NURASULOV M. SRB	4	NURASULOV M. SRB $\frac{4}{10}$ VSU				
	BYE						
5	CONYEDO RUANO A ITA	5	CONYEDO RUANO A ITA $\frac{4}{12}$ VSU1	5	CONYEDO RUANO A ITA $\frac{3}{6}$ VPO		
	BYE						
6	ALEXANDRIDIS K. GRE	6	ALEXANDRIDIS K. GRE $\frac{1}{1}$				
	BYE						
7	HEMIDA Y. EGY	7	HEMIDA Y. EGY $\frac{4}{11}$ VSU	7	HEMIDA Y. EGY $\frac{0}{0}$	5	CONYEDO RUANO A ITA $\frac{1}{1}$
	BYE						
8	KAOUSLIDIS A. CYP $\frac{3}{4}$ VPO	8	KAOUSLIDIS A. CYP $\frac{0}{0}$				
9	SAREM O. SYR $\frac{0}{0}$						

Repechage Round 1		Bronze-medal	
	BYE	3	KHELIL M. ALG $\frac{0}{0}$
3	KHELIL M. ALG	1	ERCAN S. TUR $\frac{4}{10}$ VSU
	BYE	6	ALEXANDRIDIS K. GRE $\frac{0}{0}$
6	ALEXANDRIDIS K. GRE	7	HEMIDA Y. EGY $\frac{4}{12}$ VSU

Draw number		Classification points	
1	LASTNAME Firstname NOC	$\frac{3}{5}$	VPO1
Technical points		Victory type	
Victory types			
VFA	Victory by fall	VPO	Victory by points
VIN	Victory by injury	VPO1	Victory by points - loser has points
VCA	Victory by 3 cautions	VFO	Victory by forfeit
VST	Technical superiority	DSQ	Disqualification
VST1	Great superiority	ZDSQ	Double Disqualification

Classification	
1	NURASULOV Məhomedəadzhi SRB
2	CONYEDO RUANO Abraham De Jesu ITA
3	ERCAN Salim TUR
3	HEMIDA Youssif EGY
5	KHELIL Mohamed Billal ALG
5	ALEXANDRIDIS Konstantinos GRE
7	KAOUSLIDIS Alexios CYP
8	SAREM Omar SYR
9	SHALA Egzon KOS





Salle EMEC Palais expositions

Wrestling

Men's Freestyle 125kg



## Final Classification

As of TUE 28 JUN 2022 at 21:59

Rank	Name	Country Cod
Gold	NURASULOV Magomedgadzi	SRB
Silver	CONYEDO RUANO Abraham De Jesus	ITA
Bronze	ERCAN Salim	TUR
Bronze	HEMIDA Youssif	EGY
5	KHELIL Mohamed Billal	ALG
5	ALEXANDRIDIS Konstantinos	GRE
7	KAOSLIDIS Alexios	CYP
8	SAREM Omar	SYR
9	SHALA Egzon	KOS



## Entry List by Event

As of SAT 25 JUN 2022

Ctry	Name	Date of Birth
ALG - Algeria	DOUDOU Ibtissem	20 NOV 1999
EGY - Egypt	MOHAMED Nada	16 AUG 2000
ESP - Spain	GORRIA GONI Aintzane	7 JUL 1995
FRA - France	SABATIE Julie	24 DEC 1994
ITA - Italy	LIUZZI Emanuela	27 APR 2000
TUN - Tunisia	HAMDI Sarra	13 MAR 1999
TUR - Turkey	YAVUZ Evin Demirhan	2 JUL 1995

Total: 7 wrestlers



### Competition Sheet Nordic

As of TUE 28 JUN 2022 at 11:46

1	DOUDOU I.	ALG	0/0		3	YAVUZ E.	TUR
3	YAVUZ E.	TUR	3/6	VPO			
5	GORRIA GONI A.	ESP	0/4		7	LIUZZI E.	ITA
7	LIUZZI E.	ITA	5/13	VFA			
1	DOUDOU I.	ALG	1/2		5	GORRIA GONI A.	ESP
5	GORRIA GONI A.	ESP	3/8	VPO1			
3	YAVUZ E.	TUR	5/8	VFA	3	YAVUZ E.	TUR
7	LIUZZI E.	ITA	0/1				
7	LIUZZI E.	ITA	3/3	VPO1	7	LIUZZI E.	ITA
1	DOUDOU I.	ALG	1/3				
3	YAVUZ E.	TUR	5/8	VFA	3	YAVUZ E.	TUR
5	GORRIA GONI A.	ESP	0/0				

Draw number	Classification points		
1	LASTNAME Firstname NOC	3/5 VPO1	
Technical points		Victory type	
Victory types			
VFA	Victory by fall	VPO	Victory by points
VIN	Victory by injury	VPO1	Victory by points - loser has points
VCA	Victory by 3 cautions	VFO	Victory by forfeit
VSU	Technical superiority	DSQ	Disqualification
VSU!	Great superiority	2DSQ	Double Disqualification

Group A			Matches			
Rank	Ctry	Name	Played	Won	Lost	Points
1	TUR	YAVUZ Evin Demirhan	3	3	0	13
2	ITA	LIUZZI Emanuela	3	2	1	8
3	ESP	GORRIA GONI Aintzane	3	1	2	3
4	ALG	DOUDOU Ibtissem	3	0	3	2

2	MOHAMED N.	EGY	1/3		4	SABATIE J.	FRA
4	SABATIE J.	FRA	3/10	VPO1			
6	HAMDI S.	TUN	5/3	VFA	6	HAMDI S.	TUN
2	MOHAMED N.	EGY	0/1				
4	SABATIE J.	FRA	3/4	VPO1	4	SABATIE J.	FRA
6	HAMDI S.	TUN	1/2				

Group B			Matches			
Rank	Ctry	Name	Played	Won	Lost	Points
1	FRA	SABATIE Julie	2	2	0	6
2	TUN	HAMDI Sarra	2	1	1	6
3	EGY	MOHAMED Nada	2	0	2	1



## Competition Sheet

As of WED 29 JUN 2022 at 19:27

Semi-finals

Gold-medal Bout

3	YAVUZ E.	TUR	3/6	VPO1
---	----------	-----	-----	------

3	YAVUZ E.	TUR	3/3	VPO1
---	----------	-----	-----	------

6	HAMDI S.	TUN	1/5	
---	----------	-----	-----	--

7	LIUZZI E.	ITA	1/1	
---	-----------	-----	-----	--

4	SABATIE J.	FRA	1/2	
---	------------	-----	-----	--

4	SABATIE J.	FRA	4/11	VSU1
---	------------	-----	------	------

Draw number	Classification points		Technical points		Victory type
1	LASTNAME	Firstname	NOC	3/5	VPO1
Victory types					
VFA	Victory by fall		VPO	Victory by points	
VIN	Victory by injury		VPO1	Victory by points - loser has points	
VCA	Victory by 3 cautions		VFO	Victory by forfeit	
VSU	Technical superiority		DSQ	Disqualification	
VSU1	Great superiority		ZDSQ	Double Disqualification	

GOLD

6	YAVUZ E.	TUR
---	----------	-----

SILVER

8	SABATIE J.	FRA
---	------------	-----

Classification		
1	YAVUZ Evin Demirhan	TU
2	SABATIE Julie	FR
3	HAMDI Sarra	TU
4	LIUZZI Emanuela	ITA
5	GORRIA GONI Aintzane	ES
6	DOUDOU Ibtissem	AL
7	MOHAMED Nada	EG

Bronze-medal

6	HAMDI S.	TUN	3/4	VPO1
---	----------	-----	-----	------

7	LIUZZI E.	ITA	1/2
---	-----------	-----	-----



Salle EMEC Palais expositions

Wrestling

Women's Freestyle 50kg



## Final Classification

As of WED 29 JUN 2022 at 19:28

Rank	Name	Country Cod
Gold	YAVUZ Evin Demirhan	TUR
Silver	SABATIE Julie	FRA
Bronze	HAMDI Sarra	TUN
4	LIUZZI Emanuela	ITA
5	GORRIA GONI Aintzane	ESP
6	DOUDOU Ibtissem	ALG
7	MOHAMED Nada	EGY



## Entry List by Event

As of SAT 25 JUN 2022

Ctry	Name	Date of Birth
ALG - Algeria	CHEMLAL Lamia	6 JUL 1999
EGY - Egypt	MOHAMED Shaimaa	6 MAR 2004
ESP - Spain	RUEDA FLORES Marina	13 FEB 1993
FRA - France	LUTTENAUER Emma	18 APR 2000
GRE - Greece	PREVOLARAKI Maria	21 DEC 1991
ITA - Italy	DI DIO Carmen	13 SEP 2000
MAR - Morocco	HASSOUNE Zineb	19 JAN 2001
TUR - Turkey	YETGIL Zeynep	10 OCT 2000

Total: 8 wrestlers



## Competition Sheet

As of WED 29 JUN 2022 at 19:52

Quarter-finals

Semi-finals

Gold-medal Bout

1 LUTTENAUER E. FRA  $\frac{1}{2}$

2

2 PREVOLARAKI M. GRE  $\frac{4}{10}$  VSU

2 PREVOLARAKI M. GRE  $\frac{4}{12}$  VSU1

3 RUEDA FLORES M. ESP  $\frac{5}{6}$  VFA

3

3 RUEDA FLORES M. ESP  $\frac{0}{0}$

4 HASSOUNE Z. MAR  $\frac{0}{2}$

4

5 MOHAMED S. EGY  $\frac{3}{10}$  VPO1

5

5 MOHAMED S. EGY  $\frac{1}{1}$

6 CHEMLAL L. ALG  $\frac{1}{10}$

6

7 DI DIO C. ITA  $\frac{0}{0}$

7

8 YETGIL Z. TUR  $\frac{3}{4}$  VPO1

8 YETGIL Z. TUR  $\frac{4}{10}$  VSU

8

2 PREVOLARAKI M. GRE  $\frac{3}{3}$  VPO1

8 YETGIL Z. TUR  $\frac{1}{1}$

Draw number	Classification points		
1	LASTNAME Firstname NOC	$\frac{3}{5}$ VPO1	
Technical points		Victory type	
Victory types			
VFA	Victory by fall	VPO	Victory by points
VIN	Victory by injury	VPO1	Victory by points - loser has points
VCA	Victory by 3 cautions	VFO	Victory by forfeit
VSU	Technical superiority	DSQ	Disqualification
VSU1	Great superiority	ZDSQ	Double Disqualification

GOLD

3 PREVOLARAKI M. GRE

SILVER

12 YETGIL Z. TUR

Classification		
1	PREVOLARAKI Maria	GR
2	YETGIL Zevnep	TU
3	RUEDA FLORES Marina	ES
3	MOHAMED Shaimaa	EG
5	LUTTENAUER Emma	FR
5	DI DIO Carmen	ITA
7	CHEMLAL Lamia	AL
8	HASSOUNE Zineb	M

### Bronze-medal

1 LUTTENAUER E. FRA  $\frac{1}{10}$

1

3 RUEDA FLORES M. ESP  $\frac{3}{11}$  VPO1

3

7 DI DIO C. ITA  $\frac{1}{3}$

7

5 MOHAMED S. EGY  $\frac{3}{6}$  VPO1

5



Salle EMEC Palais expositions

Wrestling

Women's Freestyle 53kg



## Final Classification

As of WED 29 JUN 2022 at 19:52

Rank	Name	Country Cod
Gold	PREVOLARAKI Maria	GRE
Silver	YETGIL Zeynep	TUR
Bronze	RUEDA FLORES Marina	ESP
Bronze	MOHAMED Shaimaa	EGY
5	LUTTENAUER Emma	FRA
5	DI DIO Carmen	ITA
7	CHEMLAL Lamia	ALG
8	HASSOUNE Zineb	MAR





## Entry List by Event

As of SAT 25 JUN 2022

Ctry	Name	Date of Birth
ALG - Algeria	HOUFAF Rayane	13 FEB 1999
EGY - Egypt	HUSSEIN Farah	7 APR 2004
ESP - Spain	SANCHEZ DIAZ Graciela	14 SEP 1995
FRA - France	SALAH DEBIEN Tatiana	30 JAN 1991
ITA - Italy	DE VITA Morena	5 APR 2000
TUN - Tunisia	BOUSETA Siwar	23 JUL 1999
TUR - Turkey	GUN Bediha	26 OCT 1994

Total: 7 wrestlers



## Competition Sheet Nordic

As of TUE 28 JUN 2022 at 11:49

1	HOUFAR R.	ALG	0 0		2	SALAH DEBIEN T.	FRA
2	SALAH DEBIEN T.	FRA	5 7	VFA			
4	GUN B.	TUR	4 10	VSU	4	GUN B.	TUR
6	HUSSEIN F.	EGY	0 0				
1	HOUFAR R.	ALG	0 0		4	GUN B.	TUR
4	GUN B.	TUR	5 3	VFA			
2	SALAH DEBIEN T.	FRA	3 4	VPO1	2	SALAH DEBIEN T.	FRA
6	HUSSEIN F.	EGY	1 2				
6	HUSSEIN F.	EGY	0 0		1	HOUFAR R.	ALG
1	HOUFAR R.	ALG	5 2	VFA			
2	SALAH DEBIEN T.	FRA	0 0		4	GUN B.	TUR
4	GUN B.	TUR	5 4	VFA			

Draw number	Classification points		
1	LASTNAME Firstname NOC	3 5 VPO1	
Technical points		Victory type	
Victory types			
VFA	Victory by fall	VPO	Victory by points
VIN	Victory by injury	VPO1	Victory by points - loser has points
VCA	Victory by 3 cautions	VFO	Victory by forfeit
VSU	Technical superiority	DSQ	Disqualification
VSU1	Great superiority	2DSQ	Double Disqualification

Group A			Matches			
Rank	Ctry	Name	Played	Won	Lost	Points
1	TUR	GUN Bediha	3	3	0	14
2	FRA	SALAH DEBIEN Tatiana	3	2	1	8
3	ALG	HOUFAR Rayane	3	1	2	5
4	EGY	HUSSEIN Farah	3	0	3	1

	DE VITA M.	ITA	0 0		3	BOUSETA S.	TUN
3	BOUSETA S.	TUN	0 0	DNS			
5	SANCHEZ DIAZ G.	ESP	0 0	DNS	5	SANCHEZ DIAZ G.	ESP
	DE VITA M.	ITA	0 0				
3	BOUSETA S.	TUN	5 4	VFA	3	BOUSETA S.	TUN
5	SANCHEZ DIAZ G.	ESP	0 0				

Group B			Matches			
Rank	Ctry	Name	Played	Won	Lost	Points
1	TUN	BOUSETA Siwar	2	2	0	5
2	ESP	SANCHEZ DIAZ Graciela	2	1	1	0
3	ITA	DE VITA Morena	2	0	2	0



## Competition Sheet

As of WED 29 JUN 2022 at 20:16

Semi-finals

Gold-medal Bout

4	GUN B.	TUR	5/6	VFA
---	--------	-----	-----	-----

4	GUN B.	TUR	5/5	VFA
---	--------	-----	-----	-----

5	SANCHEZ DIAZ G.	ESP	0/0	
---	-----------------	-----	-----	--

2	SALAH DEBIEN T.	FRA	1/3	
---	-----------------	-----	-----	--

3	BOUSETA S.	TUN	0/0	
---	------------	-----	-----	--

3	BOUSETA S.	TUN	3/4	VPO1
---	------------	-----	-----	------

Draw number	Classification points		Technical points		Victory type
1	LASTNAME	Firstname	NOC	3/5	VPO1

Victory types	
VFA	Victory by fall
VIN	Victory by injury
VCA	Victory by 3 cautions
VSU	Technical superiority
VSU1	Great superiority
VPO	Victory by points
VPO1	Victory by points - loser has points
VFO	Victory by forfeit
DSQ	Disqualification
ZDSQ	Double Disqualification

GOLD

8	GUN B.	TUR
---	--------	-----

SILVER

6	BOUSETA S.	TUN
---	------------	-----

Classification	
1	GUN Bediha TU
2	BOUSETA Siwar TU
3	SALAH DEBIEN Tatiana FR
4	SANCHEZ DIAZ Graciela ES
5	HOUFAF Ravane AL
6	HUSSEIN Farah EG
7	DE VITA Morena ITA

Bronze-medal

5	SANCHEZ DIAZ G.	ESP	1/3
---	-----------------	-----	-----

2	SALAH DEBIEN T.	FRA	3/4	VPO1
---	-----------------	-----	-----	------



Salle EMEC Palais expositions

Wrestling

Women's Freestyle 57kg



## Final Classification

As of WED 29 JUN 2022 at 20:17

Rank	Name	Country Cod
Gold	GUN Bediha	TUR
Silver	BOUSETA Siwar	TUN
Bronze	SALAH DEBIEN Tatiana	FRA
4	SANCHEZ DIAZ Graciela	ESP
5	HOUFAF Ravane	ALG
6	HUSSEIN Farah	EGY



## Entry List by Event

As of SAT 25 JUN 2022

Ctry	Name	Date of Birth
ALG - Algeria	SOUDANI Mastoura	25 JUL 2003
ESP - Spain	PEREZ TOURINO Lydia	17 OCT 1997
FRA - France	DOUARRE Améline	11 DEC 2000
ITA - Italy	ESPOSITO Elena	18 MAY 2000
SRB - Serbia	FABIAN Ana	7 JAN 1999
TUN - Tunisia	AMRI Marwa	8 JAN 1989
TUR - Turkey	TUGCU Asli	15 AUG 1996

Total: 7 wrestlers



## Competition Sheet Nordic

As of TUE 28 JUN 2022 at 12:04

1	DOUARRE A.	FRA	3/3	VPO1	1	DOUARRE A.	FRA
3	PEREZ TOURINO L	ESP	1/3				
5	TUGCU A.	TUR	4/11	VSU	5	TUGCU A.	TUR
7	FABIAN A.	SRB	0/0				
1	DOUARRE A.	FRA	3/8	VPO1	1	DOUARRE A.	FRA
5	TUGCU A.	TUR	1/1				
3	PEREZ TOURINO L	ESP	5/2	VFA	3	PEREZ TOURINO L	ESP
7	FABIAN A.	SRB	0/0				
7	FABIAN A.	SRB	1/1				
1	DOUARRE A.	FRA	3/4	VPO1	1	DOUARRE A.	FRA
3	PEREZ TOURINO L	ESP	3/6	VPO	3	PEREZ TOURINO L	ESP
5	TUGCU A.	TUR	0/0				

Draw number	Classification points		Victory type	
1	LASTNAME Firstname	NOC	3/5	VPO1
Technical points			Victory type	
Victory types				
VFA	Victory by fall		VPO	Victory by points
VIN	Victory by injury		VPO1	Victory by points - loser has points
VCA	Victory by 3 cautions		VFO	Victory by forfeit
VSU	Technical superiority		DSQ	Disqualification
VSU1	Great superiority		2DSQ	Double Disqualification

Group A			Matches			
Rank	Ctry	Name	Played	Won	Lost	Points
1	FRA	DOUARRE Ameline	3	3	0	9
2	ESP	PEREZ TOURINO Lydia	3	2	1	9
3	TUR	TUGCU Asli	3	1	2	5
4	SRB	FABIAN Ana	3	0	3	1

2	SLOUDANI M.	ALG	0/0		4	AMRI M.	TUN
4	AMRI M.	TUN	4/10	VSU			
6	ESPOSITO E.	ITA	0/0		2	SLOUDANI M.	ALG
2	SLOUDANI M.	ALG	5/2	VFA			
4	AMRI M.	TUN	5/2	VFA	4	AMRI M.	TUN
6	ESPOSITO E.	ITA	0/0				

Group B			Matches			
Rank	Ctry	Name	Played	Won	Lost	Points
1	TUN	AMRI Marwa	2	2	0	9
2	ALG	SLOUDANI Mastoura	2	1	1	5
3	ITA	ESPOSITO Elena	2	0	2	0



## Competition Sheet

As of WED 29 JUN 2022 at 20:57

Semi-finals

Gold-medal Bout

1	DOUARRE A.	FRA	3/9	VPO1
---	------------	-----	-----	------

1	DOUARRE A.	FRA	1/2	
---	------------	-----	-----	--

2	SOUDANI M.	ALG	1/3	
---	------------	-----	-----	--

3	PEREZ TOURINO L	ESP	0/0	
---	-----------------	-----	-----	--

4	AMRI M.	TUN	3/9	VPO1
---	---------	-----	-----	------

4	AMRI M.	TUN	4/11	VSU
---	---------	-----	------	-----

Draw number	Classification points	
1	LASTNAME Firstname	NOC
		3/5 VPO1
	Technical points	
	Victory type	
Victory types		
VFA	Victory by fall	VPO
VIN	Victory by injury	VPO1
VCA	Victory by 3 cautions	VFO
VSU	Technical superiority	DSQ
VSU1	Great superiority	ZDSQ
		Victory by points - loser has points
		Victory by forfeit
		Disqualification
		Double Disqualification

GOLD

8	AMRI M.	TUN
---	---------	-----

SILVER

4	DOUARRE A.	FRA
---	------------	-----

Classification		
1	AMRI Marwa	TU
2	DOUARRE Ameline	FR
3	PEREZ TOURINO Lvdia	ES
4	SOUDANI Mastoura	AL
5	TUGCU Asli	TU
6	FABIAN Ana	SR
7	ESPOSITO Elena	ITA

Bronze-medal

2	SOUDANI M.	ALG	1/11
---	------------	-----	------

3	PEREZ TOURINO L	ESP	3/13	VPO1
---	-----------------	-----	------	------



Salle EMEC Palais expositions

Wrestling

Women's Freestyle 62kg



## Final Classification

As of WED 29 JUN 2022 at 20:57

Rank	Name	Country Cod
Gold	AMRI Marwa	TUN
Silver	DOUARRE Ameline	FRA
Bronze	PEREZ TOURINO Lydia	ESP
4	SODANI Mastoura	ALG
5	TUGCU Asli	TUR
6	FABIAN Ana	SRB
7	ESPOSITO Elena	ITA





## Entry List by Event

As of SAT 25 JUN 2022

Ctry	Name	Date of Birth
ALG - Algeria	MERZOUK Thelleli	16 JUN 2002
ESP - Spain	PAMPIN BLANCO Nerea	19 NOV 1999
FRA - France	LECARPENTIER Pauline	27 MAY 1997
ITA - Italy	CANEVA Dalma	6 MAY 1994
TUN - Tunisia	JLASSI Khadija	3 JAN 2003
TUR - Turkey	TOSUN CAVUSOGLU Buse	5 DEC 1994

Total: 6 wrestlers



## Competition Sheet Nordic

As of TUE 28 JUN 2022 at 12:01

1	JLASSI K.	TUN	1/4			
3	PAMPIN BLANCO N	ESP	3/7	VPO1	3	PAMPIN BLANCO N ESP
5	CANEVA D.	ITA	1/6			
1	JLASSI K.	TUN	3/7	VPO1	1	JLASSI K. TUN
3	PAMPIN BLANCO N	ESP	0/0			
5	CANEVA D.	ITA	4/11	VSU	5	CANEVA D. ITA

Draw number	Classification points		
1	LASTNAME Firstname NOC	3/5 VPO1	
Technical points		Victory type	
Victory types			
VFA	Victory by fall	VPO	Victory by points
VIN	Victory by injury	VPO1	Victory by points - loser has points
VCA	Victory by 3 cautions	VFO	Victory by forfeit
VSU	Technical superiority	DSQ	Disqualification
VSU1	Great superiority	2DSQ	Double Disqualification

Group A			Matches			
Rank	Ctry	Name	Played	Won	Lost	Points
1	ITA	CANEVA Dalma	2	1	1	5
2	TUN	JLASSI Khadija	2	1	1	4
3	ESP	PAMPIN BLANCO Nerea	2	1	1	3

2	LECARPENTIER P.	FRA	1/6			
4	TOSUN CAVUSOGLU	TUR	3/7	VPO1	4	TOSUN CAVUSOGLU TUR
6	MERZOUK T.	ALG	0/0			
2	LECARPENTIER P.	FRA	5/12	VFA	2	LECARPENTIER P. FRA
4	TOSUN CAVUSOGLU	TUR	4/10	VSU	4	TOSUN CAVUSOGLU TUR
6	MERZOUK T.	ALG	0/0			

Group B			Matches			
Rank	Ctry	Name	Played	Won	Lost	Points
1	TUR	TOSUN CAVUSOGLU Buse	2	2	0	7
2	FRA	LECARPENTIER Pauline	2	1	1	6
3	ALG	MERZOUK Thelleli	2	0	2	0



## Competition Sheet

As of WED 29 JUN 2022 at 21:26

Semi-finals

Gold-medal Bout

5	CANEVA D.	ITA	1	1
---	-----------	-----	---	---

2	LECARPENTIER P.	FRA	3	4	VPO1
---	-----------------	-----	---	---	------

2	LECARPENTIER P.	FRA	3	2	VPO1
---	-----------------	-----	---	---	------

1	JLASSI K.	TUN	0	0
---	-----------	-----	---	---

4	TOSUN CAVUSOGLU	TUR	1	3
---	-----------------	-----	---	---

4	TOSUN CAVUSOGLU	TUR	5	9	VFA
---	-----------------	-----	---	---	-----

Draw number	Classification points		Technical points		Victory type
1	LASTNAME	Firstname	NOC	3 5	VPO1
Victory types					
VFA	Victory by fall		VPO	Victory by points	
VIN	Victory by injury		VPO1	Victory by points - loser has points	
VCA	Victory by 3 cautions		VFO	Victory by forfeit	
VSU	Technical superiority		DSQ	Disqualification	
VSU1	Great superiority		ZDSQ	Double Disqualification	

GOLD

5	LECARPENTIER P.	FRA
---	-----------------	-----

SILVER

9	TOSUN CAVUSOGLU	TUR
---	-----------------	-----

Classification		
1	LECARPENTIER Pauline	FR
2	TOSUN CAVUSOGLU Bu	TU
3	CANEVA Dalma	ITA
4	JLASSI Khadija	TU
5	PAMPIN BLANCO Nerea	ES
6	MERZOUK Thelleli	AL

Bronze-medal

5	CANEVA D.	ITA	5	5	VFA
---	-----------	-----	---	---	-----

1	JLASSI K.	TUN	0	0
---	-----------	-----	---	---



Salle EMEC Palais expositions

Wrestling

Women's Freestyle 68kg



## Final Classification

As of WED 29 JUN 2022 at 21:26

Rank	Name	Country Cod
Gold	LECARPENTIER Pauline	FRA
Silver	TOSUN CAVUSOGLU Buse	TUR
Bronze	CANEVA Dalma	ITA
4	JLASSI Khadija	TUN
5	PAMPIN BLANCO Nerea	ESP
6	MERZOUK Thelleli	ALG



## Entry List by Event

As of SAT 25 JUN 2022

Ctry	Name	Date of Birth
ALG - Algeria	BOUGHEZAL Hadil	9 NOV 2003
EGY - Egypt	HAMZA Samar	4 APR 1995
ESP - Spain	LERA CELDA Carla	17 MAY 2001
FRA - France	DACHER Kendra	8 MAY 1999
GRE - Greece	ZACHEILA Stefania	3 APR 1994
ITA - Italy	RINALDI Enrica	11 AUG 1998
TUN - Tunisia	SGHAIER Zaineb	25 SEP 2002
TUR - Turkey	ADAR YIGIT Yasemin	6 DEC 1991

Total: 8 wrestlers



## Competition Sheet

As of WED 29 JUN 2022 at 21:48

Quarter-finals

Semi-finals

Gold-medal Bout

1 DACHER K. FRA  $\frac{3}{8}$  VPO1

2 SGHAIER Z. TUN  $\frac{1}{7}$

3 ZACHEILA S. GRE  $\frac{0}{0}$

4 RINALDI E. ITA  $\frac{5}{4}$  VFA

5 HAMZA S. EGY  $\frac{0}{0}$

6 ADAR YIGIT Y. TUR  $\frac{4}{10}$  VSU

7 LERA CELDA C. ESP  $\frac{4}{11}$  VSU

8 BOUGHEZAL H. ALG  $\frac{0}{1}$

1 DACHER K. FRA  $\frac{0}{0}$

4 RINALDI E. ITA  $\frac{3}{6}$  VPO

6 ADAR YIGIT Y. TUR  $\frac{4}{10}$  VSU

7 LERA CELDA C. ESP  $\frac{0}{0}$

4 RINALDI E. ITA  $\frac{0}{0}$

6 ADAR YIGIT Y. TUR  $\frac{4}{10}$  VSU

Draw number	Classification points		
1	LASTNAME Firstname	NOC	$\frac{3}{5}$ VPO1
Technical points			Victory type
Victory types			
VFA	Victory by fall	VPO	Victory by points
VIN	Victory by injury	VPO1	Victory by points - loser has points
VCA	Victory by 3 cautions	VFO	Victory by forfeit
VSU	Technical superiority	DSQ	Disqualification
VSU1	Great superiority	ZDSQ	Double Disqualification

GOLD

9 ADAR YIGIT Y. TUR

SILVER

7 RINALDI E. ITA

Classification		
1	ADAR YIGIT Yasemin	TU
2	RINALDI Enrica	ITA
3	DACHER Kendra	FR
3	HAMZA Samar	EG
5	ZACHEILA Stefania	GR
5	LERA CELDA Carla	ES
7	SGHAIER Zaineb	TU
8	BOUGHEZAL Hadil	AL

### Bronze-medal

3 ZACHEILA S. GRE  $\frac{0}{0}$

1 DACHER K. FRA  $\frac{5}{4}$  VFA

1 DACHER K. FRA

5 HAMZA S. EGY  $\frac{5}{2}$  VFA

7 LERA CELDA C. ESP  $\frac{0}{0}$

5 HAMZA S. EGY



Salle EMEC Palais expositions

Wrestling

Women's Freestyle 76kg



## Final Classification

As of WED 29 JUN 2022 at 21:48

Rank	Name	Country Cod
Gold	ADAR YIGIT Yasemin	TUR
Silver	RINALDI Enrica	ITA
Bronze	DACHER Kendra	FRA
Bronze	HAMZA Samar	EGY
5	ZACHEILA Stefania	GRE
5	LERA CELDA Carla	ESP
7	SGHAIER Zaineb	TUN
8	BOUGHEZAL Hadil	ALG